



*CERTIFIED • OEM QUALITY • RELIABILITY*

**2019**



**WATER PUMPS**



US Motor Works has combined the strength of a technologically orientated manufacturer, superior sales and service organization and a sophisticated global distribution network to keep the company on the forefront of the automotive marketplace.

With the focus of providing Automotive and Heavy-Duty engine parts and components, US Motor Works is constantly looking for ways to support its customers by increasing the availability of quality parts and components. Currently, US Motor Works manufactures a complete line of water pumps, fuel pumps and fan clutches. In addition to our traditional Automotive and Heavy-Duty market, US Motor Works has merged with Derale Performance and Pacer Performance to expand our manufacturing and quality assurance to the High Performance industry.

Precision Engineering and manufacturing are essential in creating products that you can depend on. At US Motor Works, quality begins with skilled technicians utilizing materials that meet or exceed OEM specifications to manufacture premium water pumps, fuel pumps and fan clutches. Our specially trained technicians apply stringent quality control standards utilizing sophisticated technology to make sure that all US Motor Works products meet the rigorous demands of our customers. When you buy US Motor Works manufactured items, you are investing in technology that has been meticulously engineered, manufactured from the highest quality materials and thoroughly tested to assure accuracy, reliability and workmanship.

With more than 50 years of combined experience, we are committed to providing an extensive line of high quality products, the finest customer service and the best support program available in the automotive, high performance and heavy-duty market. Our 99.05% fill rate is proof we're on the right track.



Fan Clutches  
Water Pumps  
Fuel Pumps  
Max Cooling Kits  
Timing Kit w/ Water  
Pumps

Heavy-Duty  
Water Pumps  
Oil Pumps  
Universal Fuel Pumps  
Fuel Lift Pumps & Solenoids  
Viscous Fan Clutches

H.O. Electric Fans  
Belt Driven Fans  
Fluid Coolers  
Transmission Cooling Pans  
Fluid Filtration  
HP Fuel Pumps

Jeep Bumpers & Nerfbars  
Hi-Five Cab Roof Lights  
Flexy Flare®  
Rubber Fender Extenders  
Custom L.E.D. Lights



## A Certified ISO 9001:2015 Company



US Motor works, LLC and its employees are committed to providing an extensive line of consistent High Quality Products, the finest Customer Service and Satisfaction, through our commitment to the continual improvement of our Quality Management System of ISO 9001:2015.

## OPEX: Operational Excellence

US Motor Works adoption of OPEX is a business philosophy aimed to achieve a sustainable competitive advantage. Operational Excellence focuses on the customer's needs. By leadership, teamwork and problem solving principles, US Motor Works achieves continuous improvement, empowered employees, optimized activities and processes.

Implementation of this philosophy is built on 'Lean Manufacturing' principles designed to achieve:

- World-class quality
- Maximum productivity
- Reliable delivery to the customer
- Competitive pricing

Lean Manufacturing is the foundation of the Operational Excellence implementation program to create maximum value for your customers. It builds an integrated product delivery process to meet the changing needs of customers while creating a fundamental and sustainable change in organizational culture.

Lean Manufacturing has helped us achieve:

- Substantial response time and lead time reduction with best in class On Time Delivery rate
- Significant quality improvement, and overall cost reduction,
- Constant innovation embedded as part of the day to day work at all organizational levels
- A permanent, on-going cultural change that delivers Continuous Improvement on a daily basis, with collaboration, commitment and partnership among all of the organization's employees



# TABLE OF CONTENTS



WATER PUMPS

<b>Warranty .....</b>	<b>2</b>
<b>Water Pumps .....</b>	<b>3 - 244</b>
<b>Application Guide.....</b>	<b>5</b>
<b>Buyers Guide .....</b>	<b>135 - 190</b>
<b>Cross Reference.....</b>	<b>191 - 200</b>
<b>Identification Guide.....</b>	<b>201 - 244</b>
<b>ISO 9001:2015 Certification .....</b>	<b>247</b>
<b>US Motor Works Timeline.....</b>	<b>248</b>

All Manufacturers names, numbers, symbols and descriptions are used for reference purposes only, and in no way does it imply that any parts listed in this catalog are the products of these manufacturers.



# **WARRANTY POLICY**

## **US Motor Works, LLC**

- USMW Professional Series brand of US Motor Works, LLC products are warranted to be free from defects in material and manufacture, under normal use and service.
- US Motor Works coverage will extend a full 12 months from the date of installation in an engine regardless of mileage or hours.
- US Motor Works will cover (replace free of charge or pay for) all labor and parts needed to repair the warrantable failure, including progressive damage to the engine concerned.

### **Conditions of the warranty are:**

1. US Motor Works must be notified by the customer before filing a warranty claim.
2. All warranty claims must be in writing and US Motor Works reserves the right to examine every single engine or part subject to a claim under this warranty
3. Price of parts will be based on the US Motor Works current price list or other accepted suppliers at US Motor Work's option. Cost of labor will be of reasonable hourly flat rate (overtime or holiday rates are not accepted).

### **The warranty is also subject to the following limitations:**

1. The provisions of this warranty shall not apply to any US Motor Works (USMW) brand part altered from its original specification (including but not limited to alterations in packaging and/or markings) or which has been misused, exposed to weather conditions, negligence or damage by accident.
2. The warranty shall be null and void, if the engine or vehicle is not maintained to the suggested OEM level. All receipts and records should be accounted for in the event it is requested for the warranty analysis.
3. This warranty is provided solely to direct customers of the US Motor Works and not any other party. It is the only agreement or obligation of US Motor Works. All other warranties, expressed or implied, including the warranties of merchantability and/or fitness for a particular purpose, are excluded.

## **US Motor Works, LLC**

14722 Anson Ave.

Santa Fe Springs, CA 90670 USA

Tel (562) 404-0488 Fax (562) 404-8770

[www.usmotorworks.com](http://www.usmotorworks.com)





# WATER PUMPS

WATER PUMPS

## Full line of Import and Domestic water pumps

- Case hardened bearings
- Precision CNC machined surfaces
- The leader in metal impeller integration
- All gaskets included

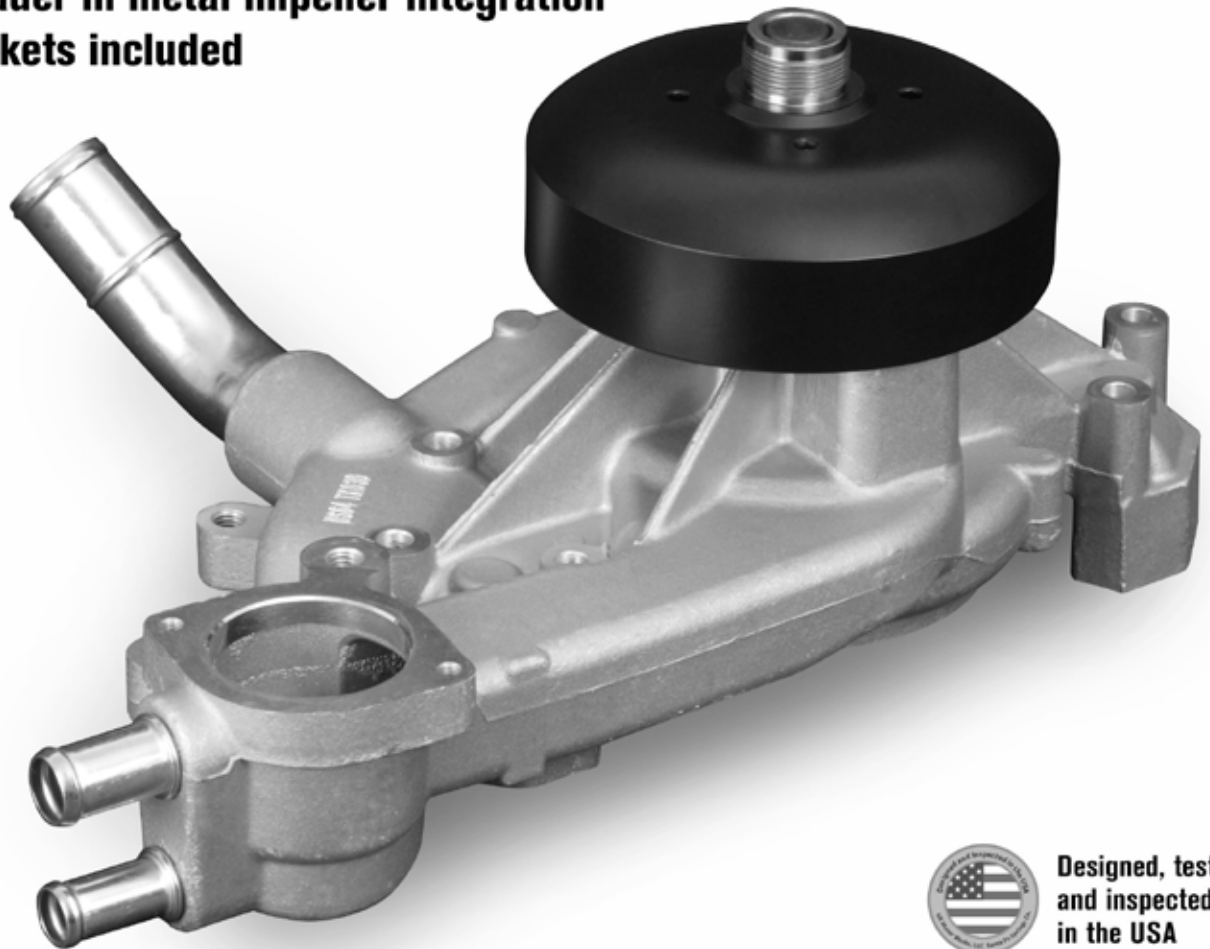

Designed, tested  
and inspected  
in the USA





# WATER PUMPS

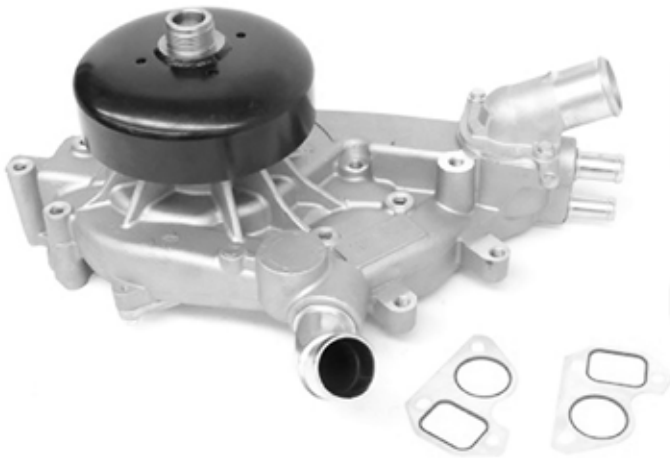

## *Benefits of case hardened bearings*

- Long life
- High load capacity
- Tough on the outside and flexible on the inside
- Can better withstand an imbalance or vibration in the cooling system



## *Benefits of precision CNC machined surfaces*

- Guaranteed fitment with mating components
- Inspected and tested to ISO9001:2015 standards
- Prevents leaks



## *Benefits of metal impellers*

- Withstands high temperatures
- Withstands chemicals
- Performs at high RPMs
- Will not deform
- Withstands high torque forces
- Will not shatter
- Will not crack during press fit
- Highly durable
- Better for transits and storage
- Withstands variables in high mileage engines



Engine	Years	Application Description	USMW	Engine	Years	Application Description	USMW
<b>ACURA</b>				<b>ACURA (cont'd.)</b>			
<b>CL</b>				<b>TL (cont'd.)</b>			
2.2L L4 2156cc	1997	Base, Premium	US9209	3.2L V6 3210cc	2002-2003	Base, Type-S	US9383
2.3L L4 2254cc	1998	Base, Premium	US9209	3.2L V6 3210cc	2004-2008	Base	US9470
2.3L L4 2254cc	1999	Premium	US9209	3.5L V6 3471cc	2007-2008	Type-S	US9470
3.0L V6 2997cc	1997-1998	Base, Premium	US9383	3.5L V6 3471cc	2009-2014	Base	US9470
3.0L V6 2997cc	1999	Premium	US9383	3.7L V6 3664cc	2009-2014	SH-AWD	US9470
3.2L V6 3210cc	2001	Premium, Type-S	US9383	<b>TLX</b>			
3.2L V6 3210cc	2002-2003	Base, Type-S	US9383	2.4L L4 2354cc 144 CID	2015-2017	Base	US8103
<b>ILX</b>				3.5L V6 3471cc	2015-2017	Base, SH-AWD	US9470
1.5L L4 1497cc	2013-2014	Hybrid	US8144	<b>TSX</b>			
2.0L L4 1997cc 122 CID	2013-2015	Base	US8112	2.4L L4 2354cc 144 CID	2004	Base	US9461
2.4L L4 2354cc 144 CID	2013-2015	Base	US6213	2.4L L4 2354cc 144 CID	2005	Base; From Engine 2035526	US9461
2.4L L4 2354cc 144 CID	2016-2017	Base	US8103	2.4L L4 2354cc 144 CID	2005	Base; To Engine 2035525	US9461
<b>INTEGRA</b>				2.4L L4 2354cc 144 CID	2006-2008	Base	US9461
1.6L L4 1590cc	1986	LS, RS	US9115	2.4L L4 2354cc 144 CID	2009-2011	Base	US6233
1.6L L4 1590cc	1987-1988	LS, LS Special Edition, RS	US9115	2.4L L4 2354cc 144 CID	2012-2014	Base, Special Edition	US6233
1.6L L4 1590cc	1989	LS, RS	US9115	3.5L V6 3471cc	2010-2014	V6	US9470
1.7L L4 1678cc	1992-1993	GS-R	US9321	<b>VIGOR</b>			
1.8L L4 1797cc	1994-1995	GS-R	US9289	2.5L L5 2451cc	1992-1994	GS, LS	US9253
1.8L L4 1797cc	1996	GS-R	US9468	<b>ZDX</b>			
1.8L L4 1797cc	1997-1998	GS-R, Type R	US9468	3.7L V6 3664cc	2010-2013	Base	US9470
1.8L L4 1797cc	1999	GS-R	US9468	<b>AMERICAN MOTORS</b>			
1.8L L4 1797cc	2000-2001	GS-R, Type R	US9468	<b>ALLIANCE</b>			
1.8L L4 1834cc	1990-1993	GS, LS, RS	US9224	1.7L L4 1700cc 104 CID	1984-1986	Mexican Application	US8914
1.8L L4 1834cc	1994	LS, RS	US9224	<b>AMERICAN</b>			
1.8L L4 1834cc	1995	LS, RS, Special Edition	US9224	3.3L L6 3300cc 199 CID	1969-1970	Mexican Application	US843
1.8L L4 1834cc	1996	LS, RS, Special Edition	US9349	3.8L L6 3800cc 232 CID	1969-1973	Mexican Application	US843
1.8L L4 1834cc	1997-1998	GS, LS, RS	US9349	3.8L L6 3800cc 232 CID	1974	Mexican Application	US986
1.8L L4 1834cc	1999-2001	GS, LS	US9349	4.2L L6 4200cc 258 CID	1973-1974	Mexican Application	US986
<b>LEGEND</b>				4.2L L6 4200cc 258 CID	1978-1979	Mexican Application	US1077
2.5L V6 2494cc	1986	Base	US9097	4.2L L6 4200cc 258 CID	1980-1983	Mexican Application	US3403
2.5L V6 2494cc	1987	Base, L	US9097	4.6L L6 4600cc 282 CID	1975-1979	Mexican Application	US1077
2.7L V6 2675cc	1987-1990	Base, L, LS	US9097	4.6L L6 4600cc 282 CID	1980-1983	Mexican Application	US3403
3.2L V6 3206cc	1991-1992	Base, L, LS	US9218	<b>AMX</b>			
3.2L V6 3206cc	1993	L, LS	US9218	4.2L L6 258 CID	1978-1979		US1077
3.2L V6 3206cc	1993	Base, L, LS	US9288	4.2L L6 258 CID	1980	Base	US3403
3.2L V6 3206cc	1994	L, LS	US9288	4.2L L6 258 CID	1980	Base; Heater fitting required, V-Belt Drive	US3414
3.2L V6 3206cc	1994-1995	GS, L, LS	US9218	5.0L V8 304 CID	1978-1979		US3401
3.2L V6 3206cc	1995	L, LS, SE	US9288	5.0L V8 304 CID	1978-1979	High performance	US3401H
<b>MDX</b>				<b>CLASSIC</b>			
3.0L V6 2997cc	2017	Sport Hybrid	US9470	3.3L L6 3261cc 199 CID	1966		US843
3.5L V6 3471cc	2001-2002	Base, Touring	US9383	3.3L L6 3300cc 199 CID	1966-1970	Mexican Application	US843
3.5L V6 3471cc	2003-2006	Base, Touring	US9470	3.8L L6 3800cc 232 CID	1967-1973	Mexican Application	US843
3.5L V6 3471cc	2014-2017	Base, SH-AWD	US9470	3.8L L6 3800cc 232 CID	1974	Mexican Application	US986
3.7L V6 3664cc	2007-2013	Base	US9470	4.2L L6 4200cc 258 CID	1972	Mexican Application	US843
<b>NSX</b>				4.2L L6 4200cc 258 CID	1973-1974	Mexican Application	US986
3.0L V6 2977cc	1991-1994	Base	US9219	4.6L L6 4600cc 282 CID	1972	Mexican Application	US843
3.0L V6 2977cc	1995	Base, T; From Engine 5300249	US9219	4.6L L6 4600cc 282 CID	1973-1974	Mexican Application	US986
3.0L V6 2977cc	1995	Base, T; To Engine 5300248	US9219	4.6L L6 4600cc 282 CID	1975-1976	Mexican Application	US1077
3.0L V6 2977cc	1996-2001	Base, T	US9219	<b>CONCORD</b>			
3.0L V6 2977cc	2002-2003	T	US9219	2.0L L4 121 CID	1978-1979		US3400
3.0L V6 2977cc	2004-2005	Base	US9219	2.5L L4 151 CID	1980-1982	Base, DL, Limited	US1107
3.2L V6 3179cc	1997-1998	Base, T	US9219	3.8L L6 232 CID	1978-1979		US1077
3.2L V6 3179cc	1999	Alex Zanardi Edition, Base, T	US9219	4.2L L6 258 CID	1978-1979		US1077
3.2L V6 3179cc	2000-2001	Base, T	US9219	4.2L L6 258 CID	1980	Base, DL, Limited	US3403
3.2L V6 3179cc	2002-2003	T	US9219	4.2L L6 258 CID	1980-1983	Base, DL, Limited; Heater fitting required, V-Belt Drive	US3414
3.2L V6 3179cc	2004-2005	Base	US9219	4.2L L6 258 CID	1981-1983	Base, DL, Limited; V-Belt Drive	US3403
<b>RDX</b>				4.2L L6 258 CID	1981-1983	Base, DL, Limited; Serpentine Belt Drive	US3404
2.3L L4 2300cc	2007-2009	Base	US6223	5.0L V8 304 CID	1978-1979		US3401
2.3L L4 2300cc	2010-2012	Base, SH-AWD	US6223	5.0L V8 304 CID	1978-1979	High performance	US3401H
3.5L V6 3471cc	2013-2017	Base	US9470	<b>EAGLE</b>			
<b>RL</b>				2.5L L4 150 CID	1983	Base, DL SX4, Limited, SX4; V-Belt Drive	US3403
3.5L V6 3471cc	2005-2008	Base	US9470	2.5L L4 150 CID	1983	Base, DL SX4, Limited, SX4; Serpentine Belt Drive	US3404
3.5L V6 3475cc	1996-1997	Base, Premium	US9354	2.5L L4 150 CID	1983	Base, DL SX4, Limited, SX4; Heater fitting required, V-Belt Drive	US3414
3.5L V6 3475cc	1998	Base, Premium, SE	US9354	2.5L L4 150 CID	1984	Base, Limited; V-Belt Drive	US3403
3.5L V6 3475cc	1999-2004	Premium	US9354	2.5L L4 150 CID	1984	Base, Limited; Serpentine Belt Drive	US3413
3.7L V6 3664cc	2009-2012	Base	US9470	2.5L L4 150 CID	1984	Base, Limited; Heater fitting required, V-Belt Drive	US3414
<b>RLX</b>				2.5L L4 151 CID	1981-1982	Base, DL Kammback, DL SX4, Kammback, Limited, SX4	US1107
3.5L V6 3471cc	2014	Base, Sport Hybrid SH-AWD	US9470	2.5L L4 151 CID	1983	Base, DL SX4, Limited, SX4	US1107
3.5L V6 3471cc	2015	Base	US9470	4.2L L6 258 CID	1980	DL, Limited, Sport	US3403
3.5L V6 3471cc	2016-2017	Base, Sport Hybrid SH-AWD	US9470	4.2L L6 258 CID	1980	DL, Limited, Sport; Heater fitting required, V-Belt Drive	US3414
<b>RSX</b>				4.2L L6 258 CID	1981-1982	Base, DL Kammback, DL SX4, Kammback, Limited, SX4	US1107
2.0L L4 1998cc 122 CID	2002-2006	Type-S	US6703	4.2L L6 258 CID	1980	DL, Limited, Sport	US3403
2.0L L4 1998cc 122 CID	2002-2006	Base	US9434	4.2L L6 258 CID	1981-1982	Base, DL Kammback, DL SX4, Kammback, Limited, SX4; V-Belt Drive	US3403
<b>SLX</b>				<b>WATER PUMPS</b>			
3.2L V6 3165cc	1996-1997	Base, Premium	US9278				
3.5L V6 3494cc	1998-1999	Premium	US9365				
<b>TL</b>							
2.5L L5 2451cc	1995-1998	Base, Premium	US9253				
3.2L V6 3206cc	1996-1998	Base, Premium	US9348				
3.2L V6 3210cc	1999-2001	Base	US9383				



# WATER PUMP APPLICATION GUIDE



Engine	Years	Application Description	USMW
<b>AMERICAN MOTORS (cont'd.)</b>			
<b>EAGLE (cont'd.)</b>			
4.2L L6 258 CID	1981-1982	Base, DL Kammback, DL SX4, Kammback, Limited, SX4; Serpentine Belt Drive	<b>US3404</b>
4.2L L6 258 CID	1981-1982	Base, DL Kammback, DL SX4, Kammback, Limited, SX4; Heater fitting required, V-Belt Drive	<b>US3414</b>
4.2L L6 258 CID	1983	Base, DL SX4, Limited, SX4; V-Belt Drive	<b>US3403</b>
4.2L L6 258 CID	1983	Base, DL SX4, Limited, SX4; Serpentine Belt Drive	<b>US3404</b>
4.2L L6 258 CID	1983	Base, DL SX4, Limited, SX4; Heater fitting required, V-Belt Drive	<b>US3414</b>
4.2L L6 258 CID	1984-1987	Base, Limited; V-Belt Drive	<b>US3403</b>
4.2L L6 258 CID	1984-1987	Base, Limited; Serpentine Belt Drive	<b>US3413</b>
4.2L L6 258 CID	1984-1987	Base, Limited; Heater fitting required, V-Belt Drive	<b>US3414</b>
4.2L L6 258 CID	1988	Base; V-Belt Drive	<b>US3403</b>
4.2L L6 258 CID	1988	Base; Serpentine Belt Drive	<b>US3413</b>
4.2L L6 258 CID	1988	Base; Heater fitting required, V-Belt Drive	<b>US3414</b>
<b>ENCORE</b>			
1.7L L4 1700cc 104 CID	1985-1986	Mexican Application	<b>US8914</b>
<b>GREMLIN</b>			
2.0L L4 121 CID	1977-1978		<b>US3400</b>
3.8L L6 232 CID	1975-1978		<b>US1077</b>
4.2L L6 258 CID	1975-1978		<b>US1077</b>
4.2L L6 4200cc 258 CID	1973-1974	Mexican Application	<b>US986</b>
4.2L L6 4200cc 258 CID	1975	Mexican Application	<b>US1077</b>
4.2L L6 4200cc 258 CID	1979	Mexican Application	<b>US1077</b>
4.2L L6 4200cc 258 CID	1980-1983	Mexican Application	<b>US3403</b>
4.2L L6 4228cc 258 CID	1974		<b>US986</b>
4.2L L6 4229cc 258 CID	1974		<b>US986</b>
4.6L L6 4600cc 282 CID	1979	Mexican Application	<b>US1077</b>
4.6L L6 4600cc 282 CID	1980-1983	Mexican Application	<b>US3403</b>
5.0L V8 304 CID	1975-1976		<b>US3401</b>
5.0L V8 304 CID	1975-1976	High performance	<b>US3401H</b>
<b>HORNET</b>			
3.8L L6 232 CID	1975-1977		<b>US1077</b>
4.2L L6 258 CID	1975-1977		<b>US1077</b>
5.0L V8 304 CID	1975-1977		<b>US3401</b>
5.0L V8 304 CID	1975-1977	High performance	<b>US3401H</b>
<b>JAVELIN</b>			
4.2L L6 4200cc 258 CID	1971-1973	Mexican Application	<b>US986</b>
4.6L L6 4600cc 282 CID	1968-1973	Mexican Application	<b>US986</b>
<b>LERMA</b>			
4.6L L6 4600cc 282 CID	1980-1983	Mexican Application	<b>US3403</b>
<b>MATADOR</b>			
4.2L L6 258 CID	1975-1978		<b>US1077</b>
5.0L V8 304 CID	1975-1977		<b>US3401</b>
5.0L V8 304 CID	1975-1977	High performance	<b>US3401H</b>
5.9L V8 360 CID	1975-1978		<b>US3401</b>
5.9L V8 360 CID	1975-1978	High performance	<b>US3401H</b>
6.6L V8 401 CID	1975-1976		<b>US3401</b>
6.6L V8 401 CID	1975-1976	High performance	<b>US3401H</b>
<b>PACER</b>			
3.8L L6 232 CID	1975-1978		<b>US1077</b>
4.2L L6 258 CID	1975-1979		<b>US1077</b>
4.2L L6 258 CID	1980	DL, Limited	<b>US3403</b>
4.2L L6 258 CID	1980	DL, Limited; Heater fitting required, V-Belt Drive	<b>US3414</b>
4.6L L6 4600cc 282 CID	1975-1979	Mexican Application	<b>US1077</b>
5.0L V8 304 CID	1978-1979		<b>US3401</b>
5.0L V8 304 CID	1978-1979	High performance	<b>US3401H</b>
<b>RALLY</b>			
4.2L L6 4200cc 258 CID	1981-1983	Mexican Application	<b>US3403</b>
4.6L L6 4600cc 282 CID	1981-1983	Mexican Application	<b>US3403</b>
<b>SPIRIT</b>			
2.0L L4 121 CID	1979		<b>US3400</b>
2.5L L4 151 CID	1980	Base, DL, Limited	<b>US1107</b>
2.5L L4 151 CID	1981-1982	Base, DL	<b>US1107</b>
3.8L L6 232 CID	1979		<b>US1077</b>
4.2L L6 258 CID	1979		<b>US1077</b>
4.2L L6 258 CID	1980	Base, DL, Limited	<b>US3403</b>
4.2L L6 258 CID	1980	Base, DL, Limited; Heater fitting required, V-Belt Drive	<b>US3414</b>
4.2L L6 258 CID	1981-1982	Base, DL; V-Belt Drive	<b>US3403</b>
4.2L L6 258 CID	1981-1982	Base, DL; Serpentine Belt Drive	<b>US3404</b>
4.2L L6 258 CID	1981-1982	Base, DL; Heater fitting required, V-Belt Drive	<b>US3414</b>
4.2L L6 258 CID	1983	DL, GT; V-Belt Drive	<b>US3403</b>
4.2L L6 258 CID	1983	DL, GT; Serpentine Belt Drive	<b>US3404</b>
4.2L L6 258 CID	1983	DL, GT; Heater fitting required, V-Belt Drive	<b>US3414</b>

Engine	Years	Application Description	USMW
<b>AM GENERAL</b>			
<b>HUMMER</b>			
5.7L V8 350 CID	1995-1996	Base	<b>US5049</b>
5.7L V8 350 CID	1995-1996	Base; High performance	<b>US5049H</b>
6.2L V8 379 CID	1992-1993	Base	<b>US5008</b>
6.5L V8 395 CID	1994-1995	Base	<b>US5062</b>
6.5L V8 395 CID	1996	Base; (Y), Naturally Aspirated	<b>US5062</b>
6.5L V8 395 CID	1996	Base; (Z), Turbocharged	<b>US5074</b>
6.5L V8 395 CID	1996-1998	Base; (Z), FI, Turbocharged	<b>US5074</b>
6.5L V8 395 CID	1997-1998	Base	<b>US5074</b>
6.5L V8 395 CID	1997-1998	Base; (Y), FI, Naturally Aspirated	<b>US5074</b>
6.5L V8 395 CID	1999-2001	Base	<b>US5086</b>
<b>AUDI</b>			
<b>80</b>			
2.0L L4 1983cc	1988-1990	Base	<b>US9065</b>
2.0L L4 1983cc	1988-1990	Base; Includes back housing	<b>US9065-2</b>
2.3L L5 2309cc	1991-1992	Base	<b>US9171</b>
<b>80 QUATTRO</b>			
2.3L L5 2309cc	1988	Base; To Chassis/VIN 89-J-394 742	<b>US9052</b>
2.3L L5 2309cc	1988	Base; From Chassis/VIN 89-J-394 743	<b>US9171</b>
2.3L L5 2309cc	1989-1992	Base	<b>US9171</b>
<b>90</b>			
2.0L L4 1983cc	1988	Base	<b>US9065</b>
2.0L L4 1983cc	1988	Base; Includes back housing	<b>US9065-2</b>
2.3L L5 2309cc	1988	Base; To Chassis/VIN 89-J-396 702	<b>US9052</b>
2.3L L5 2309cc	1988	Base; From Chassis/VIN 89-7-396-703	<b>US9171</b>
2.3L L5 2309cc	1989-1991	Base	<b>US9171</b>
2.8L V6 2771cc	1993-1994	CS, S	<b>US9263</b>
2.8L V6 2771cc	1995	Base, Sport; To Chassis/VIN 8CS025820	<b>US9263</b>
2.8L V6 2771cc	1995	Base, Sport; From Chassis/VIN 8CS025821	<b>US9333</b>
<b>90 QUATTRO</b>			
2.3L L5 2309cc	1988	Base; To Chassis/VIN 89-J-394 742	<b>US9052</b>
2.3L L5 2309cc	1988	Base; From Chassis/VIN 89-J-394 743	<b>US9171</b>
2.3L L5 2309cc	1989	Base	<b>US9171</b>
2.3L L5 2309cc	1990-1991	20v	<b>US9171</b>
2.8L V6 2771cc	1993-1994	CS	<b>US9263</b>
2.8L V6 2771cc	1995	Base, Sport	<b>US9333</b>
<b>100</b>			
2.3L L5 2309cc	1989	Base, E	<b>US9171</b>
2.3L L5 2309cc	1990-1991	Base	<b>US9171</b>
2.8L V6 2771cc	1992-1993	Base, CS, S	<b>US9263</b>
2.8L V6 2771cc	1994	CS, S	<b>US9263</b>
<b>100 QUATTRO</b>			
2.3L L5 2309cc	1989-1991	Base	<b>US9171</b>
2.8L V6 2771cc	1992-1994	CS	<b>US9263</b>
<b>200</b>			
2.2L L5 2226cc	1989-1991	Base	<b>US9171</b>
<b>200 QUATTRO</b>			
2.2L L5 2226cc	1989	Base; To Engine MC 039 950	<b>US9052</b>
2.2L L5 2226cc	1989	Base; From Engine MC 039 951	<b>US9171</b>
2.2L L5 2226cc	1990	Base	<b>US9171</b>
2.2L L5 2226cc	1991	20v, 20v Avant, Avant, Base	<b>US9171</b>
<b>4000</b>			
1.6L L4 1588cc 97 CID	1980	Base	<b>US9066</b>
1.6L L4 1588cc 97 CID	1982-1983	Base, S	<b>US9065</b>
1.6L L4 1588cc 97 CID	1982-1983	Base, S; Includes back housing	<b>US9065-2</b>
1.7L L4 1715cc	1981	Base; From Chassis/VIN 81-B-149 001	<b>US9065</b>
1.7L L4 1715cc	1981	Base; From Chassis/VIN 81-B-149 001, Includes back housing	<b>US9065-2</b>
1.7L L4 1715cc	1981	Base; To Chassis/VIN 81-B-149 000	<b>US9066</b>
1.7L L4 1715cc	1982-1983	Base, GT, S	<b>US9065</b>
1.7L L4 1715cc	1982-1983	Base, GT, S; Includes back housing	<b>US9065-2</b>
1.8L L4 1780cc	1984-1987	S	<b>US9065</b>
1.8L L4 1780cc	1984-1987	S; Includes back housing	<b>US9065-2</b>
2.2L L5 2144cc	1980-1981	Base	<b>US9052</b>
2.2L L5 2144cc	1982-1983	Base, GT, S	<b>US9052</b>
<b>4000 QUATTRO</b>			
2.2L L5 2226cc	1984-1985	S	<b>US9052</b>
2.2L L5 2226cc	1986-1987	CS	<b>US9052</b>
<b>5000</b>			
2.0L L5 1986cc	1979		<b>US9071</b>
2.0L L5 1986cc	1980-1981	Base, S	<b>US9071</b>
2.0L L5 1986cc	1982-1983	Base	<b>US9071</b>
2.2L L5 2144cc	1980	Base, S	<b>US9052</b>
2.2L L5 2144cc	1981-1983	Base, S, S Turbo	<b>US9052</b>
2.2L L5 2144cc	1984	S, S Turbo	<b>US9052</b>
2.2L L5 2144cc	1985	CS Turbo, S Turbo	<b>US9052</b>
2.2L L5 2226cc	1985	S	<b>US9052</b>
2.2L L5 2226cc	1986-1987	CS, S	<b>US9052</b>
2.2L L5 2226cc	1988	CS	<b>US9052</b>





# WATER PUMP APPLICATION GUIDE



Engine	Years	Application Description	USMW	Engine	Years	Application Description	USMW
<b>AUDI (cont'd.)</b>				<b>AUDI (cont'd.)</b>			
<b>5000 (cont'd.)</b>				<b>A4 (cont'd.)</b>			
2.3L L5 2309cc	1987-1988	S	US9052	2.8L V6 2771cc	1998	Avant, Base	US9333
<b>5000 QUATTRO</b>				2.8L V6 2771cc	1999-2001	Base	US9333
2.2L L5 2226cc	1986-1988	CS	US9052	3.0L V6 2976cc	2002	Base	US9429
2.3L L5 2309cc	1987-1988	S	US9052	3.0L V6 2976cc	2003-2005	Base, Cabriolet	US9429
<b>A1</b>				3.2L V6 3123cc	2006-2008	Base	US6146
1.4L L4 1390cc 85 CID	2016	Mexican Application	US8952	3.2L V6 3200cc 195 CID	2010	Mexican Application	US6146
<b>A3</b>				<b>A4 QUATTRO</b>			
1.4L L4 1368cc 83 CID	2008-2009	Mexican Application	US8977	1.8L L4 1781cc	1997-1998	Base	US9401
1.4L L4 1390cc 85 CID	2013	Mexican Application	US8952	1.8L L4 1781cc	1999-2000	Avant, Base	US9401
1.4L L4 1395cc 85 CID	2016	Mexican Application	US8952	1.8L L4 1781cc	2001-2005	Avant, Base	US9377
1.8L L4 1754cc 107 CID	1999-2001	Mexican Application	US9377	2.0L L4 1984cc 121 CID	2005-2006	Avant, Base	US6022
1.8L L4 1781cc 108 CID	2002-2004	Mexican Application	US9377	2.0L L4 1984cc 121 CID	2007-2008	Avant, Base, Cabriolet	US6022
1.8L L4 1781cc 108 CID	2008-2010	Mexican Application	US9377	2.0L L4 1984cc 121 CID	2009	Cabriolet	US6022
2.0L H4 1984cc 121 CID	2006-2007	Mexican Application	US6022	2.0L L4 1984cc 121 CID	2009-2012	Avant, Base; Pump only	US9047
2.0L L4 1968cc 120 CID	2010-2013	TDI	US6034	2.0L L4 1984cc 121 CID	2009-2012	Avant, Base; With back plate housing	US9047-2
2.0L L4 1984cc 121 CID	2004-2005	Mexican Application	US9377	2.0L L4 1984cc 121 CID	2013	Base; From 05/15/2013, Pump only	US9047
2.0L L4 1984cc 121 CID	2006-2007	Base	US6022	2.0L L4 1984cc 121 CID	2013	Base; Pump only, To 05/15/2013	US9047
2.0L L4 1984cc 121 CID	2006-2008	Base	US11017	2.0L L4 1984cc 121 CID	2013	Base; From 05/15/2013, With back plate housing	US9047-2
2.0L L4 1984cc 121 CID	2008	Base; (BPY), (F)	US6022	2.0L L4 1984cc 121 CID	2013	Base; To 05/15/2013, With back plate housing	US9047-2
2.0L L4 1984cc 121 CID	2008-2009	Base; (CBFA); Pump only	US9047	2.0L L4 1984cc 121 CID	2013-2014	Base; Pump only	US9047
2.0L L4 1984cc 121 CID	2008-2009	Base; (CBFA); With back plate housing	US9047-2	2.0L L4 1984cc 121 CID	2013-2014	Base; With back plate housing	US9047-2
2.0L L4 1984cc 121 CID	2008-2011	Base; (CCTA); Pump only	US9047	2.0L L4 1984cc 121 CID	2014	Base; Includes back housing	US9047-2
2.0L L4 1984cc 121 CID	2008-2011	Base; (CCTA); With back plate housing	US9047-2	2.0L L4 1984cc 121 CID	2015	Premium, Premium Plus, Prestige; Pump only	US9047
2.0L L4 1984cc 121 CID	2008-2013	Base; Electric Water Pump	US11008	2.0L L4 1984cc 121 CID	2015	Premium, Premium Plus, Prestige; Includes back housing	US9047-2
2.0L L4 1984cc 121 CID	2010	Base; (CBFA); Pump only, To 05/17/2010	US9047	2.0L L4 1984cc 121 CID	2015	Premium, Premium Plus, Prestige; With back plate housing	US9047-2
2.0L L4 1984cc 121 CID	2010	Base; (CBFA); To 05/17/2010, With back plate housing	US9047-2	2.0L L4 1984cc 121 CID	2016	Premium, Premium Plus; Pump only	US9047
2.0L L4 1984cc 121 CID	2012	Base; (CCTA); From 06/01/2012, Pump only	US9047	2.0L L4 1984cc 121 CID	2016	Premium, Premium Plus; Includes back housing	US9047-2
2.0L L4 1984cc 121 CID	2012	Base; (CCTA); Pump only, To 06/01/2012	US9047	2.8L V6 2771cc	1996-1997	Base	US9333
2.0L L4 1984cc 121 CID	2012	Base; (CCTA); From 06/01/2012, With back plate housing	US9047-2	2.8L V6 2771cc	1998-2001	Avant, Base	US9333
2.0L L4 1984cc 121 CID	2012	Base; (CCTA); To 06/01/2012, With back plate housing	US9047-2	3.0L V6 2976cc	2002-2003	Avant, Base	US9429
2.0L L4 1984cc 121 CID	2012	Base; (CCTA); Pump only	US9047	3.0L V6 2976cc	2004-2005	Avant, Base, Cabriolet	US9429
2.0L L4 1984cc 121 CID	2013	Base; (CCTA); With back plate housing	US9047-2	3.0L V6 2976cc	2006	Cabriolet	US9429
2.0L L4 1984cc 121 CID	2013	Base; (CCTA); With back plate housing	US9047-2	3.2L V6 3123cc	2005-2006	Avant, Base	US6146
2.0L L4 1984cc 121 CID	2005	Mexican Application	US9377	3.2L V6 3123cc	2007-2008	Avant, Base, Cabriolet	US6146
3.2L V6 3189cc 195 CID	2004-2005	Mexican Application	US9471	3.2L V6 3123cc	2009	Cabriolet	US6146
<b>A3 QUATTRO</b>				3.2L V6 3123cc	2009	Base; From Chassis/VIN 8K-9-213 001	US6249
2.0L L4 1984cc 121 CID	2009	Base; (CCTA); Pump only	US9047	3.2L V6 3123cc	2009	Base; To Chassis/VIN 8K-9-213 000	US6249
2.0L L4 1984cc 121 CID	2009	Base; (CCTA); With back plate housing	US9047-2	<b>A5</b>			
2.0L L4 1984cc 121 CID	2009-2013	Electric Water Pump	US11008	2.0L L4 1984cc 121 CID	2010-2014	Cabriolet; Pump only	US9047
2.0L L4 1984cc 121 CID	2010-2011	Base; Pump only	US9047	2.0L L4 1984cc 121 CID	2010-2014	Cabriolet; With back plate housing	US9047-2
2.0L L4 1984cc 121 CID	2010-2011	Base; With back plate housing	US9047-2	2.0L L4 1984cc 121 CID	2014	Cabriolet; Includes back housing	US9047-2
2.0L L4 1984cc 121 CID	2012	Base; From 06/01/2012, Pump only	US9047	3.2L V6 3200cc 195 CID	2008	Mexican Application	US9471
2.0L L4 1984cc 121 CID	2012	Base; Pump only, To 06/01/2012	US9047	<b>A5 QUATTRO</b>			
2.0L L4 1984cc 121 CID	2012	Base; From 06/01/2012, With back plate housing	US9047-2	2.0L L4 1984cc 121 CID	2010-2014	Base, Cabriolet; Pump only	US9047
2.0L L4 1984cc 121 CID	2012	Base; To 06/01/2012, With back plate housing	US9047-2	2.0L L4 1984cc 121 CID	2010-2014	Base, Cabriolet; With back plate housing	US9047-2
2.0L L4 1984cc 121 CID	2013	Base; Pump only	US9047	2.0L L4 1984cc 121 CID	2014	Base, Cabriolet; Includes back housing	US9047-2
2.0L L4 1984cc 121 CID	2013	Base; With back plate housing	US9047-2	2.0L L4 1984cc 121 CID	2015	Premium, Premium Plus, Prestige; Pump only	US9047
3.2L V6 3189cc 195 CID	2006-2009	Base	US9471	2.0L L4 1984cc 121 CID	2015	Premium, Premium Plus, Prestige; Includes back housing	US9047-2
3.2L V6 3189cc 195 CID	2006-2009	Base; Electric Water Pump	US11004	2.0L L4 1984cc 121 CID	2015	Premium, Premium Plus, Prestige; With back plate housing	US9047-2
<b>A4</b>				2.0L L4 1984cc 121 CID	2015	Premium, Premium Plus; Pump only	US9047
1.8L L4 1781cc	1997-2000	Base	US9401	2.0L L4 1984cc 121 CID	2016	Premium, Premium Plus; Includes back housing	US9047-2
1.8L L4 1781cc	2001-2002	Base	US9377	2.0L L4 1984cc 121 CID	2016	Premium, Premium Plus; Pump only	US9047
1.8L L4 1781cc	2003-2005	Base, Cabriolet	US9377	2.0L L4 1984cc 121 CID	2016	Premium, Premium Plus; Includes back housing	US9047-2
1.8L L4 1781cc	2006	Cabriolet	US9377	2.0L L4 1984cc 121 CID	2017	Sport; Pump only	US9047
1.8L L4 1781cc 108 CID	2007-2009	Mexican Application	US9377	2.0L L4 1984cc 121 CID	2017	Sport; Includes back housing	US9047-2
2.0L L4 1984cc 121 CID	2005-2006	Base	US6022	3.2L V6 3123cc	2008	Base	US6249
2.0L L4 1984cc 121 CID	2007-2008	Base, Cabriolet	US6022	3.2L V6 3123cc	2009	Base; From Chassis/VIN 8T-9-039 001	US6249
2.0L L4 1984cc 121 CID	2009	Cabriolet	US6022	3.2L V6 3123cc	2009	Base; To Chassis/VIN 8T-9-039 000	US6249
2.0L L4 1984cc 121 CID	2009-2012	Base; Pump only	US9047	3.2L V6 3123cc	2009-2010	Base; HVAC System	US11017
2.0L L4 1984cc 121 CID	2009-2012	Base; With back plate housing	US9047-2	3.2L V6 3123cc	2010	Base	US6249
2.0L L4 1984cc 121 CID	2013	Base; From 05/15/2013, Pump only	US9047	<b>A6</b>			
2.0L L4 1984cc 121 CID	2013	Base; Pump only, To 05/15/2013	US9047	2.0L L4 1984cc 121 CID	2012	Premium, Premium Plus; Pump only	US9047
2.0L L4 1984cc 121 CID	2013	Base; From 05/15/2013, With back plate housing	US9047-2	2.0L L4 1984cc 121 CID	2012	Premium, Premium Plus; With back plate housing	US9047-2
2.0L L4 1984cc 121 CID	2013	Base; To 05/15/2013, With back plate housing	US9047-2	2.0L L4 1984cc 121 CID	2013	Premium, Premium Plus; From 06/03/2012, Pump only	US9047
2.0L L4 1984cc 121 CID	2014	Base; Pump only	US9047	2.0L L4 1984cc 121 CID	2013	Premium, Premium Plus; Pump only, To 06/03/2012	US9047
2.0L L4 1984cc 121 CID	2014	Base; Includes back housing	US9047-2	2.0L L4 1984cc 121 CID	2013	Premium, Premium Plus; From 06/03/2012, With back plate housing	US9047-2
2.0L L4 1984cc 121 CID	2014	Base; With back plate housing	US9047-2	2.0L L4 1984cc 121 CID	2013	Premium, Premium Plus; To 06/03/2012, With back plate housing	US9047-2
2.0L L4 1984cc 121 CID	2015	Premium, Premium Plus, Prestige; Pump only	US9047	2.0L L4 1984cc 121 CID	2014-2015	Premium, Premium Plus; Pump only	US9047
2.0L L4 1984cc 121 CID	2015	Premium, Premium Plus, Prestige; Includes back housing	US9047-2	2.0L L4 1984cc 121 CID	2014-2015	Premium, Premium Plus; Includes back housing	US9047-2
2.0L L4 1984cc 121 CID	2015	Premium, Premium Plus, Prestige; With back plate housing	US9047-2	2.0L L4 1984cc 121 CID	2014-2015	Premium, Premium Plus; With back plate housing	US9047-2
2.0L L4 1984cc 121 CID	2016	Premium, Premium Plus; Pump only	US9047	2.8L V6 2771cc	1995	Avant, Base; (A); To Chassis/VIN #4A-S-026 714	US9263
2.0L L4 1984cc 121 CID	2016	Premium, Premium Plus; Includes back housing	US9047-2				
2.8L V6 2771cc	1996-1997	Base	US9333				

WATER PUMPS



Engine	Years	Application Description	USMW
<b>AUDI (cont'd.)</b>			
<b>A6 (cont'd.)</b>			
2.8L V6 2771cc	1995	Avant, Base; (C); To Chassis/VIN #4A-S-026 714	US9263
2.8L V6 2771cc	1995	Avant, Base; To Chassis/VIN #4A-S-026 714	US9263
2.8L V6 2771cc	1995	Avant, Base; (A); From Chassis/VIN #4A-S-026 715	US9333
2.8L V6 2771cc	1995	Avant, Base; (C); From Chassis/VIN #4A-S-026 715	US9333
2.8L V6 2771cc	1995	Avant, Base; From Chassis/VIN #4A-S-026 715	US9333
2.8L V6 2771cc	1996-1997	Avant, Base	US9333
2.8L V6 2771cc	1998-2001	Base	US9333
2.8L V6 2773cc	2008-2009	Base	US9429
3.0L V6 2976cc	2002-2004	Base	US9429
3.0L V6 2976cc 182 CID	2005-2006	Mexican Application	US9429
3.2L V6 3123cc	2006-2009	Base	US6146
3.2L V6 3123cc	2010	Base; From 06/10/2010	US6249
3.2L V6 3123cc	2010	Base; To 06/10/2010	US6249
3.2L V6 3123cc	2011	Base	US6249
<b>A6 QUATTRO</b>			
2.0L L4 1984cc 121 CID	2013	Premium, Premium Plus; From 06/03/2012, Pump only	US9047
2.0L L4 1984cc 121 CID	2013	Premium, Premium Plus; Pump only, To 06/03/2012	US9047
2.0L L4 1984cc 121 CID	2013	Premium, Premium Plus; From 06/03/2012, With back plate housing	US9047-2
2.0L L4 1984cc 121 CID	2013	Premium, Premium Plus; To 06/03/2012, With back plate housing	US9047-2
2.0L L4 1984cc 121 CID	2014-2015	Premium, Premium Plus; Pump only	US9047
2.0L L4 1984cc 121 CID	2014-2015	Premium, Premium Plus; Includes back housing	US9047-2
2.0L L4 1984cc 121 CID	2014-2015	Premium, Premium Plus; With back plate housing	US9047-2
2.7L V6 2671cc	2000-2002	Base; Electric Water Pump	US11003
2.7L V6 2671cc	2000-2004	Base	US9446
2.7L V6 2671cc	2003-2004	Base; Electric Water Pump	US11004
2.8L V6 2771cc	1995	Avant, Base; To Chassis/VIN #4A-S-026 714	US9263
2.8L V6 2771cc	1995	Avant, Base; From Chassis/VIN #4A-S-026 715	US9333
2.8L V6 2771cc	1996-2001	Avant, Base	US9333
3.0L V6 2976cc	2002-2004	Avant, Base	US9429
3.0L V6 2995cc	2009	Avant	US6146
3.0L V6 2995cc	2009	Base; From Chassis/VIN 4F-9-047 001	US6146
3.0L V6 2995cc	2009	Base; To Chassis/VIN 4F-9-047 000	US6146
3.0L V6 2995cc	2010-2011	Avant, Base	US6146
3.2L V6 3123cc	2005	Base	US6146
3.2L V6 3123cc	2006-2008	Avant, Base	US6146
4.2L V8 4163cc	2005-2006	Base	US6000
4.2L V8 4163cc	2007-2011	Base	US6702
4.2L V8 4172cc	2000-2004	Base	US9410
<b>A8</b>			
3.7L V8 3697cc	1997-1999	Base	US9362
4.2L V8 4163cc 254 CID	2012	Mexican Application	US6702
<b>A8 QUATTRO</b>			
4.2L V8 4163cc	2007-2012	Base, L	US6702
4.2L V8 4172cc	1997-1999	Base	US9362
4.2L V8 4172cc	2000-2003	Base, L	US9410
4.2L V8 4172cc	2004	L	US9410
4.2L V8 4172cc	2005-2006	Base, L	US9410
6.0L W12 5998cc	2005-2009	L	US8111
<b>ALLROAD</b>			
2.0L L4 1984cc 121 CID	2013-2015	Premium, Premium Plus, Prestige; Pump only	US9047
2.0L L4 1984cc 121 CID	2013-2015	Premium, Premium Plus, Prestige; With back plate housing	US9047-2
2.0L L4 1984cc 121 CID	2014-2015	Premium, Premium Plus, Prestige; Includes back housing	US9047-2
2.0L L4 1984cc 121 CID	2016	Premium, Premium Plus; Pump only	US9047
2.0L L4 1984cc 121 CID	2016	Premium, Premium Plus; Includes back housing	US9047-2
<b>ALLROAD QUATTRO</b>			
2.7L V6 2671cc	2001-2002	Base; Electric Water Pump	US11003
2.7L V6 2671cc	2001-2005	Base	US9446
2.7L V6 2671cc	2003-2005	Base; Electric Water Pump	US11004
4.2L V8 4172cc	2004-2005	Base	US6000
<b>CABRIOLET</b>			
2.8L V6 2771cc	1994	Base	US9263
2.8L V6 2771cc	1995	Base; (A); To Chassis/VIN 8G-S-001 302	US9263
2.8L V6 2771cc	1995	Base; (L); To Chassis/VIN 8G-S-001 302	US9263
2.8L V6 2771cc	1995	Base; (A); From Chassis/VIN 8G-S-001 303	US9333
2.8L V6 2771cc	1995	Base; (L); From Chassis/VIN 8G-S-001 303	US9333
2.8L V6 2771cc	1996-1998	Base	US9333

Engine	Years	Application Description	USMW
<b>AUDI (cont'd.)</b>			
<b>COUPE</b>			
2.2L L5 2144cc	1981-1984	Base	US9052
2.2L L5 2226cc	1984-1985	Base	US9052
2.2L L5 2226cc	1986-1987	GT	US9052
2.3L L5 2309cc	1987	GT	US9052
<b>COUPE QUATTRO</b>			
2.3L L5 2309cc	1990-1991	20v	US9171
<b>FOX</b>			
1.6L L4 1588cc 97 CID	1975-1979		US9066
<b>Q3</b>			
2.0L L4 1984cc 121 CID	2015	Premium Plus, Prestige; With back plate housing	US9047-2
2.0L L4 1984cc 121 CID	2015-2016	Premium Plus, Prestige; Pump only	US9047
2.0L L4 1984cc 121 CID	2015-2016	Premium Plus, Prestige; Includes back housing	US9047-2
2.0L L4 1984cc 121 CID	2017	Premium, Premium Plus, Prestige; Pump only	US9047
2.0L L4 1984cc 121 CID	2017	Premium, Premium Plus, Prestige; Includes back housing	US9047-2
<b>Q3 QUATTRO</b>			
2.0L L4 1984cc 121 CID	2015	Premium Plus, Prestige; With back plate housing	US9047-2
2.0L L4 1984cc 121 CID	2015-2016	Premium Plus, Prestige; Pump only	US9047
2.0L L4 1984cc 121 CID	2015-2016	Premium Plus, Prestige; Includes back housing	US9047-2
2.0L L4 1984cc 121 CID	2017	Premium, Premium Plus, Prestige; Pump only	US9047
2.0L L4 1984cc 121 CID	2017	Premium, Premium Plus, Prestige; Includes back housing	US9047-2
<b>Q5</b>			
2.0L L4 1984cc 121 CID	2011-2012	Premium, Premium Plus; Pump only	US9047
2.0L L4 1984cc 121 CID	2011-2012	Premium, Premium Plus; With back plate housing	US9047-2
2.0L L4 1984cc 121 CID	2013-2015	Hybrid Prestige, Premium, Premium Plus; With back plate housing	US9047-2
2.0L L4 1984cc 121 CID	2013-2016	Hybrid Prestige, Premium, Premium Plus; Pump only	US9047
2.0L L4 1984cc 121 CID	2014-2016	Hybrid Prestige, Premium, Premium Plus; Includes back housing	US9047-2
2.0L L4 1984cc 121 CID	2017	Premium, Premium Plus; Pump only	US9047
2.0L L4 1984cc 121 CID	2017	Premium, Premium Plus; Includes back housing	US9047-2
3.0L V6 2967cc 182 CID	2012	Mexican Application	US6146
3.2L V6 3123cc	2009	Premium, Premium Plus, Prestige; From Chassis/VIN 8R-9-037 001	US6249
3.2L V6 3123cc	2009	Premium, Premium Plus, Prestige; To Chassis/VIN 8R-9-037 000	US6249
3.2L V6 3123cc	2009-2010	Premium, Premium Plus, Prestige; HVAC System	US11017
3.2L V6 3123cc	2010	Premium, Premium Plus, Prestige; From 06/10/2010	US6249
3.2L V6 3123cc	2010	Premium, Premium Plus, Prestige; To 06/10/2010	US6249
3.2L V6 3123cc	2011-2012	Premium Plus, Prestige	US6249
3.2L V6 3123cc	2011-2012	Premium Plus, Prestige; HVAC System	US11017
3.2L V6 3200cc 195 CID	2010-2012	Mexican Application	US6249
<b>Q7</b>			
3.0L V6 2967cc 181 CID	2009-2010	TDI	US6146
3.0L V6 2967cc 181 CID	2011-2012	TDI Premium, TDI Premium Plus, TDI Prestige	US6146
3.0L V6 2967cc 182 CID	2008	Mexican Application	US9471
3.0L V6 2967cc 182 CID	2011-2013	Mexican Application	US6146
3.0L V6 2995cc	2011-2015	Premium, Premium Plus, Prestige	US6146
3.6L V6 3597cc 219 CID	2007-2010	Base, Premium	US6221
3.6L V6 3597cc 219 CID	2007-2010	Base, Premium; Electric Water Pump	US11004
4.2L V8 4163cc	2007	Base, Premium	US6702
4.2L V8 4163cc	2008-2009	Premium	US6702
4.2L V8 4163cc	2010	Prestige	US6702
4.2L V8 4163cc 254 CID	2008-2009	Mexican Application	US9410
<b>QUATTRO</b>			
2.2L L5 2144cc	1983-1985	Base	US9052
<b>R8</b>			
4.2L V8 4163cc	2008-2010	Base; Electric Water Pump	US11004
4.2L V8 4163cc	2011-2012	Base, Spyder; Electric Water Pump	US11004
4.2L V8 4163cc	2014	Base, Spyder; Electric Water Pump	US11004
4.2L V8 4163cc	2014-2015	Base, Spyder	US6702
4.2L V8 4163cc	2014-2015	Base	US6702
5.2L V10 5204cc	2010	Base; Electric Water Pump	US11004
5.2L V10 5204cc	2011	Base, Spyder; Electric Water Pump	US11004
5.2L V10 5204cc	2012	Base, GT, GT Spyder, Spyder; Electric Water Pump	US11004
5.2L V10 5204cc	2014	Base, Plus, Spyder; Electric Water Pump	US11004
<b>RS4</b>			
4.2L V8 4172cc	2007	Base	US6000
4.2L V8 4172cc	2007	Base	US6702

Engine	Years	Application Description	USMW	Engine	Years	Application Description	USMW
<b>AUDI (cont'd.)</b>				<b>AUDI (cont'd.)</b>			
<b>RS4 (cont'd.)</b>				<b>TT QUATTRO (cont'd.)</b>			
4.2L V8 4172cc	2008	Base, Cabriolet	<b>US6000</b>	3.2L V6 3189cc 195 CID	2006	Base, Special Edition	<b>US9471</b>
4.2L V8 4172cc	2008	Base, Cabriolet	<b>US6702</b>	3.2L V6 3189cc 195 CID	2006	Base, Special Edition; Electric Water Pump	<b>US11004</b>
<b>RS5</b>				3.2L V6 3189cc 195 CID	2008-2009	Base	<b>US9471</b>
4.2L V8 4163cc 254 CID	2013	Base	<b>US6702</b>	3.2L V6 3189cc 195 CID	2008-2009	Base; Electric Water Pump	<b>US11004</b>
4.2L V8 4163cc 254 CID	2014-2015	Base, Cabriolet	<b>US6702</b>	<b>V8 QUATTRO</b>			
<b>RS6</b>				3.6L V8 3562cc	1990-1991	Base	<b>US9226</b>
4.2L V8 4172cc	2003	Base	<b>US9410</b>	4.2L V8 4172cc	1992-1994	Base	<b>US9226</b>
<b>RS6 QUATTRO</b>				<b>AVANTI</b>			
4.2L V8 4179cc 255 CID	2004	Mexican Application	<b>US9410</b>	<b>II</b>			
<b>S3 QUATTRO</b>				5.3L V8 5358cc 327 CID	1965-1969		<b>US898</b>
1.8L L4 1754cc 107 CID	2000-2001	Mexican Application	<b>US9377</b>	5.3L V8 5358cc 327 CID	1965-1969	High performance	<b>US898H</b>
1.8L L4 1781cc 108 CID	2002-2004	Mexican Application	<b>US9377</b>	5.4L V8 327 CID	1968-1969		<b>US898</b>
2.0L L4 1998cc 122 CID	2008-2011	Mexican Application	<b>US9377</b>	5.4L V8 327 CID	1968-1969	High performance	<b>US898H</b>
<b>S4</b>				5.7L V8 350 CID	1969		<b>US898</b>
2.2L L5 2226cc	1992-1994	Base	<b>US9279</b>	5.7L V8 350 CID	1969	High performance	<b>US898H</b>
2.7L V6 2671cc	2000	Base	<b>US9446</b>	5.7L V8 5736cc 350 CID	1969		<b>US898</b>
2.7L V6 2671cc	2000	Base; Electric Water Pump	<b>US11003</b>	5.7L V8 5736cc 350 CID	1969	High performance	<b>US898H</b>
2.7L V6 2671cc	2001-2002	Avant, Base	<b>US9446</b>	<b>BMW</b>			
2.7L V6 2671cc	2001-2002	Avant, Base; Electric Water Pump	<b>US11003</b>	<b>1 SERIES M</b>			
3.0L V6 2995cc	2010-2012	Base	<b>US6146</b>	3.0L L6 2979cc	2011	Base	<b>US6681</b>
4.2L V8 4163cc	2004-2008	Avant, Base, Cabriolet	<b>US6000</b>	<b>128I</b>			
4.2L V8 4163cc	2009	Cabriolet	<b>US6000</b>	3.0L L6 2996cc	2008-2013	Base	<b>US6680</b>
<b>S5</b>				<b>130I</b>			
3.0L V6 2995cc	2010-2012	Cabriolet	<b>US6146</b>	3.0L L6 2996cc 183 CID	2006-2010	Mexican Application	<b>US9261</b>
4.2L V8 4163cc	2008-2012	Base	<b>US6702</b>	<b>135I</b>			
<b>S6</b>				3.0L L6 2979cc	2008-2013	Base	<b>US6681</b>
2.2L L5 2226cc	1995	Avant, Base	<b>US9279</b>	<b>228I</b>			
4.2L V8 4172cc	2002-2003	Avant	<b>US9410</b>	2.0L L4 1997cc 122 CID	2014-2016	Base	<b>US8135</b>
5.2L V10 5204cc	2007-2011	Base	<b>US6702</b>	<b>228I XDRIVE</b>			
<b>S6 QUATTRO</b>				2.0L L4 1997cc 122 CID	2015-2016	Base	<b>US8135</b>
4.2L V8 4172cc 255 CID	2001	Mexican Application	<b>US9410</b>	<b>318</b>			
4.2L V8 4172cc 255 CID	2004	Mexican Application	<b>US9410</b>	1.8L L4 1800cc 110 CID	1986	Mexican Application	<b>US9152</b>
<b>S8</b>				<b>318I</b>			
4.2L V8 4172cc	2001-2003	Base	<b>US9410</b>	1.8L L4 1766cc 107 CID	1984-1985	Base	<b>US9152</b>
5.2L V10 5204cc	2007-2009	Base	<b>US6702</b>	1.8L L4 1796cc	1991-1995	Base	<b>US9275</b>
<b>TT</b>				1.8L L4 1800cc 110 CID	1997	Mexican Application	<b>US9275</b>
1.8L L4 1781cc	2000-2006	Base	<b>US9377</b>	1.9L L4 1895cc	1996-1998	Base	<b>US9275</b>
1.8L L4 1781cc	2002-2006	Base; Electric Water Pump	<b>US11003</b>	<b>318IS</b>			
2.0L L4 1984cc 121 CID	2008-2009	Base; (BPY)	<b>US6022</b>	1.8L L4 1796cc	1991-1995	Base	<b>US9275</b>
2.0L L4 1984cc 121 CID	2008-2009	Base	<b>US11017</b>	1.9L L4 1895cc	1996-1997	Base	<b>US9275</b>
2.0L L4 1984cc 121 CID	2009	Base; (CCTA); Pump only	<b>US9047</b>	<b>318TI</b>			
2.0L L4 1984cc 121 CID	2009	Base; (CCTA); With back plate housing	<b>US9047-2</b>	1.8L L4 1796cc	1995	Base	<b>US9275</b>
2.0L L4 1984cc 121 CID	2009	Base; Electric Water Pump	<b>US11008</b>	1.9L L4 1895cc	1996-1999	Base	<b>US9275</b>
2.0L L4 1984cc 122 CID	2007	Mexican Application	<b>US9377</b>	<b>320I</b>			
2.0L L4 1984cc 122 CID	2010	Mexican Application	<b>US9377</b>	1.8L L4 1766cc 107 CID	1980-1983	Base	<b>US9149</b>
<b>TT QUATTRO</b>				2.0L L4 1990cc 121 CID	1977-1979		<b>US9149</b>
1.8L L4 1781cc	2000-2001	Base	<b>US9377</b>	2.2L L6 2171cc 132 CID	2001-2005	Mexican Application	<b>US9261</b>
1.8L L4 1781cc	2001	Base; Electric Water Pump	<b>US11003</b>	<b>323CI</b>			
1.8L L4 1781cc	2002	ALMS Edition, Base	<b>US9377</b>	2.5L L6 2494cc 152 CID	2000	Base	<b>US9261</b>
1.8L L4 1781cc	2002	ALMS Edition, Base; Electric Water Pump	<b>US11003</b>	<b>323I</b>			
1.8L L4 1781cc	2003-2006	Base	<b>US9377</b>	2.5L L6 2494cc 152 CID	1997-1998	Mexican Application	<b>US9261</b>
1.8L L4 1781cc	2003-2006	Base; Electric Water Pump	<b>US11003</b>	2.5L L6 2494cc 152 CID	1998-2000	Base	<b>US9261</b>
2.0L L4 1984cc 121 CID	2009-2010	Base, S; Electric Water Pump	<b>US11008</b>	<b>323IS</b>			
2.0L L4 1984cc 121 CID	2009-2011	Base; Pump only	<b>US9047</b>	2.5L L6 2494cc 152 CID	1998-1999	Base	<b>US9261</b>
2.0L L4 1984cc 121 CID	2009-2011	Base; With back plate housing	<b>US9047-2</b>	<b>325</b>			
2.0L L4 1984cc 121 CID	2009-2015	S	<b>US6022</b>	2.7L L6 2693cc	1986-1987	Base	<b>US9119</b>
2.0L L4 1984cc 121 CID	2011	Base; Electric Water Pump	<b>US11008</b>	2.7L L6 2693cc	1988	Base	<b>US9120</b>
2.0L L4 1984cc 121 CID	2011-2015	S	<b>US11017</b>	<b>325CI</b>			
2.0L L4 1984cc 121 CID	2012	Premium Plus, Prestige; From 06/03/2012, Pump only	<b>US9047</b>	2.5L L6 2494cc 152 CID	2001-2006	Base	<b>US9261</b>
2.0L L4 1984cc 121 CID	2012	Premium Plus, Prestige; Pump only, To 06/03/2012	<b>US9047</b>	<b>325E</b>			
2.0L L4 1984cc 121 CID	2012	Premium Plus, Prestige; From 06/03/2012, With back plate housing	<b>US9047-2</b>	2.7L L6 2693cc	1984-1987	Base	<b>US9119</b>
2.0L L4 1984cc 121 CID	2012	Premium Plus, Prestige; To 06/03/2012, With back plate housing	<b>US9047-2</b>	<b>325ES</b>			
2.0L L4 1984cc 121 CID	2012	Premium Plus, Prestige; Electric Water Pump	<b>US11008</b>	2.7L L6 2693cc	1986-1987	Base	<b>US9119</b>
2.0L L4 1984cc 121 CID	2013	Premium Plus, Prestige; Pump only	<b>US9047</b>	<b>325I</b>			
2.0L L4 1984cc 121 CID	2013	Premium Plus, Prestige; With back plate housing	<b>US9047-2</b>	2.5L L6 2494cc 152 CID	1987	Base	<b>US9119</b>
2.0L L4 1984cc 121 CID	2013	Base, Premium Plus, Prestige; Electric Water Pump	<b>US11008</b>	2.5L L6 2494cc 152 CID	1988-1991	Base	<b>US9120</b>
2.0L L4 1984cc 121 CID	2014	Base; Electric Water Pump	<b>US11008</b>	2.5L L6 2494cc 152 CID	1992	Base; (M50)	<b>US9261</b>
2.0L L4 1984cc 121 CID	2014-2015	Base	<b>US9047</b>	2.5L L6 2494cc 152 CID	1992-1993	Base; (M20)	<b>US9120</b>
2.0L L4 1984cc 121 CID	2014-2015	Base; Pump only	<b>US9047</b>	2.5L L6 2494cc 152 CID	1993	Base; (M50TU)	<b>US9261</b>
2.0L L4 1984cc 121 CID	2014-2015	Base	<b>US9047-2</b>	2.5L L6 2494cc 152 CID	1994-1995	Base	<b>US9261</b>
2.0L L4 1984cc 121 CID	2014-2015	Base; With back plate housing	<b>US9047-2</b>	2.5L L6 2494cc 152 CID	1996-1997	Mexican Application	<b>US9261</b>
3.2L V6 3189cc 195 CID	2004-2005	Base	<b>US9471</b>	2.5L L6 2494cc 152 CID	2001-2005	Base	<b>US9261</b>
3.2L V6 3189cc 195 CID	2004-2005	Base; Electric Water Pump	<b>US11004</b>				



# WATER PUMP APPLICATION GUIDE



Engine	Years	Application Description	USMW	Engine	Years	Application Description	USMW
<b>BMW (cont'd.)</b>				<b>BMW (cont'd.)</b>			
<b>325I (cont'd.)</b>				<b>528I XDRIVE (cont'd.)</b>			
2.5L L6 2494cc 152 CID	2011-2013	Mexican Application	US9261	3.0L L6 2996cc	2009-2010	Base	US6680
2.5L L6 2497cc 152 CID	2006-2010	Mexican Application	US9261	<b>528XI</b>			
<b>325IS</b>				3.0L L6 2996cc	2008	Base	US6680
2.5L L6 2494cc 152 CID	1987	Base	US9119	<b>530I</b>			
2.5L L6 2494cc 152 CID	1988-1991	Base	US9120	3.0L L6 2979cc	2001-2005	Base	US9261
2.5L L6 2494cc 152 CID	1992-1995	Base	US9261	3.0L L6 2985cc	1975-1978		US9122
<b>325IX</b>				3.0L L6 2996cc 183 CID	2008-2010	Mexican Application	US9261
2.5L L6 2494cc 152 CID	1988-1991	Base	US9120	3.0L V8 2997cc	1994-1995	Base	US9276
<b>325XI</b>				<b>533I</b>			
2.5L L6 2494cc 152 CID	2001-2005	Base	US9261	3.2L L6 3210cc	1983-1984	Base	US9117
<b>328CI</b>				<b>535I</b>			
2.8L L6 2793cc	2000	Base	US9261	3.0L L6 2979cc	2008-2016	Base	US6681
<b>328I</b>				3.5L L6 3430cc	1985-1993	Base	US9117
2.0L L4 1997cc 122 CID	2012-2016	Base	US8135	<b>535I GT</b>			
2.8L L6 2793cc	1996-2000	Base	US9261	3.0L L6 2979cc	2010-2017	Base	US6681
3.0L L6 2996cc	2007-2013	Base	US6680	<b>535I GT XDRIVE</b>			
<b>328I GT XDRIVE</b>				3.0L L6 2979cc	2011-2017	Base	US6681
2.0L L4 1997cc 122 CID	2014-2016	Base	US8135	<b>535IS</b>			
<b>328IS</b>				3.5L L6 3430cc	1988	Base	US9117
2.8L L6 2793cc	1996-1999	Base	US9261	<b>535I XDRIVE</b>			
<b>328I XDRIVE</b>				3.0L L6 2979cc	2009-2016	Base	US6681
2.0L L4 1997cc 122 CID	2013-2016	Base	US8135	<b>535XI</b>			
3.0L L6 2996cc	2009-2013	Base	US6680	3.0L L6 2979cc	2008	Base	US6681
<b>328XI</b>				<b>540I</b>			
3.0L L6 2996cc	2007-2008	Base	US6680	4.0L V8 3982cc	1994-1995	Base	US9276
<b>330CI</b>				4.0L V8 3982cc 243 CID	1996	Mexican Application	US9332
3.0L L6 2979cc	2001-2006	Base	US9261	4.4L V8 4398cc	1997-1998	Base	US8926
<b>330I</b>				4.4L V8 4398cc	1999-2003	Base	US9465
3.0L L6 2979cc	2001-2005	Base	US9261	<b>545I</b>			
3.0L L6 2996cc 183 CID	2007	Mexican Application	US9261	4.4L V8 4398cc	2004-2005		US8990
<b>330XI</b>				<b>550I</b>			
3.0L L6 2979cc	2001-2005	Base	US9261	4.4L V8 4395cc	2011-2016	Base	US6708
<b>335I</b>				4.8L V8 4837cc	2006-2010	Base	US6238
3.0L L6 2979cc	2007-2012	Base	US6681	<b>550I GT</b>			
3.0L L6 2979cc	2013	Base; Exc.Sedan	US6681	4.4L V8 4395cc	2010-2015	Base	US6708
<b>335IS</b>				<b>550I GT XDRIVE</b>			
3.0L L6 2979cc	2011-2013	Base	US6681	4.4L V8 4395cc	2010-2017	Base	US6708
<b>335I XDRIVE</b>				<b>550I XDRIVE</b>			
3.0L L6 2979cc	2009-2012	Base	US6681	4.4L V8 4395cc	2011-2016	Base	US6708
3.0L L6 2979cc	2013	Base; Exc.Sedan	US6681	<b>630CSI</b>			
<b>335XI</b>				3.0L L6 2985cc	1977-1978		US9122
3.0L L6 2979cc	2007-2008	Base	US6681	<b>633CSI</b>			
<b>428I</b>				3.2L L6 3210cc	1978-1979		US9122
2.0L L4 1997cc 122 CID	2014-2016	Base	US8135	3.2L L6 3210cc	1980-1984	Base	US9117
<b>428I GRAN COUPE</b>				<b>635CSI</b>			
2.0L L4 1997cc 122 CID	2015-2016	Base	US8135	3.5L L6 3430cc	1985-1989	Base	US9117
<b>428I XDRIVE</b>				<b>640I</b>			
2.0L L4 1997cc 122 CID	2014-2016	Base	US8135	3.0L L6 2979cc	2012-2017	Base	US6681
<b>428I XDRIVE GRAN COUPE</b>				<b>640I GRAN COUPE</b>			
2.0L L4 1997cc 122 CID	2015-2016	Base	US8135	3.0L L6 2979cc	2013-2017	Base	US6681
<b>524TD</b>				3.0L L6 2979cc 182 CID	2016	Base	US6681
2.4L L6 2443cc	1985-1986	Base	US9154	<b>640I XDRIVE</b>			
<b>525I</b>				3.0L L6 2979cc	2014-2017	Base	US6681
2.5L L6 2494cc 152 CID	1986	Mexican Application	US9234	<b>640I XDRIVE GRAN COUPE</b>			
2.5L L6 2494cc 152 CID	1989-1990	Base	US9120	3.0L L6 2979cc	2014-2017	Base	US6681
2.5L L6 2494cc 152 CID	1991-1995	Base	US9261	<b>645CI</b>			
2.5L L6 2494cc 152 CID	2001-2005	Base	US9261	4.4L V8 4398cc	2004-2005		US8990
2.5L L6 2497cc 152 CID	2006-2010	Mexican Application	US9261	<b>650I</b>			
<b>528</b>				4.4L V8 4395cc	2012-2017	Base	US6708
2.8L L6 2800cc 173 CID	1996	Mexican Application	US9261	4.4L V8 4395cc 268 CID	2014-2015	Base	US6708
<b>528E</b>				4.8L V8 4837cc	2006-2010	Base	US6238
2.7L L6 2693cc	1982-1987	Base	US9119	<b>650I GRAN COUPE</b>			
2.7L L6 2693cc	1988	Base	US9120	4.4L V8 4395cc	2013-2017	Base	US6708
<b>528I</b>				4.4L V8 4395cc 268 CID	2015-2016	Base	US6708
2.0L L4 1997cc 122 CID	2012-2016	Base	US8135	<b>650I XDRIVE</b>			
2.8L L6 2788cc	1979		US9122	4.4L V8 4395cc	2012-2017	Base	US6708
2.8L L6 2788cc	1980-1981	Base	US9117	<b>650I XDRIVE GRAN COUPE</b>			
2.8L L6 2793cc	1997-2000	Base	US9261	4.4L V8 4395cc	2013-2017	Base	US6708
3.0L L6 2996cc	2008-2010	Base	US6680				
<b>528I XDRIVE</b>							
2.0L L4 1997cc 122 CID	2012-2016	Base	US8135				



Engine	Years	Application Description	USMW
<b>BMW (cont'd.)</b>			
<b>728I</b>			
2.8L L6 2788cc 170 CID	1997	Mexican Application	US9261
<b>733I</b>			
3.2L L6 3210cc	1978-1979		US9122
3.2L L6 3210cc	1980-1984	Base	US9117
<b>735I</b>			
3.5L L6 3430cc	1985-1987	Base	US9122
3.5L L6 3430cc	1988-1992	Base	US9117
<b>735IL</b>			
3.5L L6 3430cc	1988-1992	Base	US9117
<b>740I</b>			
3.0L L6 2979cc	2011-2015	Base	US6681
3.0L L6 2979cc 182 CID	2013-2015	Base	US6681
4.0L V8 3982cc	1993-1994	Base	US9276
4.0L V8 3982cc	1995	Base	US9332
4.4L V8 4398cc	1997-1998	Base	US8926
4.4L V8 4398cc	1999-2001	Base	US9465
<b>740IL</b>			
4.0L V8 3982cc	1993-1994	Base	US9276
4.0L V8 3982cc	1995	Base	US9332
4.4L V8 4398cc	1996-1998	Base	US8926
4.4L V8 4398cc	1999-2001	Base	US9465
<b>740LI</b>			
3.0L L6 2979cc	2011		US6681
3.0L L6 2979cc	2012-2015	Base	US6681
<b>740LI XDRIVE</b>			
3.0L L6 2979cc	2013-2015	Base	US6681
<b>745I</b>			
4.4L V8 4398cc	2002-2003	Base	US6003
4.4L V8 4398cc	2004	Base; To 10/03	US6003
4.4L V8 4398cc	2004-2005		US8990
<b>745LI</b>			
4.4L V8 4398cc	2002-2005		US8990
<b>750I</b>			
4.4L V8 4395cc	2009-2010	Base	US6708
4.4L V8 4395cc	2011-2012	ActiveHybrid, Base	US6708
4.4L V8 4395cc	2013-2016	Base	US6708
4.4L V8 4395cc 268 CID	2014-2015	Base	US6708
4.8L V8 4837cc	2006-2008	Base	US6238
<b>750IL</b>			
5.0L V12 4988cc	1988-1994	Base	US9128
5.4L V12 5379cc	1995-1998	Base	US9464
5.4L V12 5379cc	1998-2001	Base	US9467
<b>750I XDRIVE</b>			
4.4L V8 4395cc	2010-2016	Base	US6708
<b>750LI</b>			
4.4L V8 4395cc	2009-2010	Base	US6708
4.4L V8 4395cc	2011-2012	ActiveHybrid, Base	US6708
4.4L V8 4395cc	2013-2015	Base	US6708
4.4L V8 4395cc 268 CID	2014-2015	Base	US6708
4.8L V8 4837cc	2006-2008	Base	US6238
<b>750LI XDRIVE</b>			
4.4L V8 4395cc	2010-2015	Base	US6708
<b>760I</b>			
6.0L V12 5972cc	2004-2005	Base	US6003
<b>760LI</b>			
6.0L V12 5972cc	2003-2005	Base	US6003
<b>840CI</b>			
4.0L V8 3982cc	1994-1995	Base	US9332
4.4L V8 4398cc	1996-1997	Base	US8926
<b>850</b>			
5.0L V12 5000cc 305 CID	1995	Mexican Application	US9236
<b>850CI</b>			
5.0L V12 4988cc	1993-1994	Base	US9236
5.0L V12 5000cc 305 CID	1996-1997	Mexican Application	US9236
5.4L V12 5379cc	1995-1997	Base	US9464
5.4L V12 5379cc 328 CID	1998	Mexican Application	US9464
<b>850CSI</b>			
5.6L V12 5576cc	1994-1995	Base	US9236
<b>850I</b>			
5.0L V12 4988cc	1991-1992	Base	US9236

Engine	Years	Application Description	USMW
<b>BMW (cont'd.)</b>			
<b>850I (cont'd.)</b>			
5.0L V12 5000cc 305 CID	1990	Mexican Application	US9236
<b>2002</b>			
2.0L L4 1990cc 121 CID	1975-1976		US9153
<b>ACTIVEHYBRID 5</b>			
3.0L L6 2979cc	2012-2016	Base	US6681
<b>ACTIVEHYBRID 7</b>			
3.0L L6 2979cc	2013-2015	Base	US6681
<b>ALPINA B6 XDRIVE GRAN COUPE</b>			
4.4L V8 4395cc	2015-2017	Base	US6708
<b>ALPINA B7</b>			
4.4L V8 4395cc	2011-2015	Base	US6708
4.4L V8 4398cc	2007-2008		US8990
<b>ALPINA B7L</b>			
4.4L V8 4395cc	2011-2015	Base	US6708
<b>ALPINA B7L XDRIVE</b>			
4.4L V8 4395cc	2011-2015	Base	US6708
<b>ALPINA B7 XDRIVE</b>			
4.4L V8 4395cc	2011-2015	Base	US6708
<b>L6</b>			
3.5L L6 3430cc	1987	Base	US9117
<b>L7</b>			
3.5L L6 3430cc	1986-1987	Base	US9117
<b>M3</b>			
3.0L L6 2990cc	1995	Base, Lightweight	US9261
3.0L L6 2990cc 182 CID	1994	Mexican Application	US9261
3.0L L6 2990cc 182 CID	1996	Mexican Application	US9261
3.2L L6 3152cc	1996-1999	Base	US9261
<b>M5</b>			
3.4L L6 3430cc 209 CID	1993-1994	Mexican Application	US9275
3.5L L6 3453cc	1988	Base	US9117
3.6L L6 3553cc	1991-1993	Base	US9234
<b>M6</b>			
3.5L L6 3453cc	1987-1988	Base	US9117
<b>X1</b>			
2.0L L4 1997cc 122 CID	2013-2014	sDrive28i, xDrive28i	US8135
2.0L L4 1997cc 122 CID	2015	xDrive28i	US8135
3.0L L6 2979cc	2013-2015	xDrive35i	US6681
<b>X3</b>			
2.0L L4 1997cc 122 CID	2013-2014	xDrive28i	US8135
2.0L L4 1997cc 122 CID	2015-2017	sDrive28i, xDrive28i	US8135
2.5L L6 2494cc 152 CID	2004-2005	2.5i	US9261
2.5L L6 2494cc 152 CID	2006-2009	Mexican Application	US9261
2.5L L6 2497cc 152 CID	2010	Mexican Application	US9261
3.0L L6 2979cc	2004-2006	3.0i	US9261
3.0L L6 2979cc	2011-2017	xDrive35i	US6681
3.0L L6 2979cc 182 CID	2014	xDrive35i	US6681
3.0L L6 2996cc	2007-2008	3.0si	US6680
3.0L L6 2996cc	2009-2010	xDrive30i	US6680
3.0L L6 2996cc 183 CID	2010	Mexican Application	US6680
<b>X4</b>			
2.0L L4 1997cc 122 CID	2015-2017	xDrive28i	US8135
3.0L L6 2979cc	2015	xDrive35i	US6681
3.0L L6 2979cc	2016	M40i, xDrive35i	US6681
3.0L L6 2979cc	2017	M40i	US6681
<b>X5</b>			
2.0L L4 1997cc 122 CID	2016-2017	xDrive40e	US8135
3.0L L6 2979cc	2001-2006	3.0i	US9261
3.0L L6 2979cc	2011-2013	xDrive35i	US6681
3.0L L6 2979cc 182 CID	2013	xDrive35i	US6681
3.0L L6 2996cc	2007-2008	3.0si; (N52B30A); Exc. Auxiliary A/C	US6680
3.0L L6 2996cc	2009-2010	xDrive30i; Exc. Auxiliary A/C	US6680
4.4L V8 4395cc	2010	M	US6708
4.4L V8 4395cc	2011-2012	M, xDrive50i	US6708
4.4L V8 4395cc	2013	M	US6708
4.4L V8 4395cc	2013	xDrive50i; (N63B44A)	US6708
4.4L V8 4395cc	2014-2017	xDrive50i	US6708
4.4L V8 4395cc 268 CID	2014	xDrive50i	US6708
4.4L V8 4398cc	2000-2003	4.4i	US9465
4.4L V8 4398cc	2004-2006	4.4i	US8990
4.6L V8 4598cc	2002-2003	4.6is	US9465
4.8L V8 4837cc	2004-2006	4.8is	US8990
4.8L V8 4837cc	2007-2008	4.8i	US6238
4.8L V8 4837cc	2009-2010	xDrive48i	US6238
<b>X6</b>			
3.0L L6 2979cc	2008-2014	xDrive35i	US6681

WATER PUMPS



# WATER PUMP APPLICATION GUIDE



Engine	Years	Application Description	USMW	Engine	Years	Application Description	USMW
<b>BMW (cont'd.)</b>				<b>BUICK (cont'd.)</b>			
<b>X6 (cont'd.)</b>				<b>CENTURY (cont'd.)</b>			
3.0L L6 2979cc 182 CID	2013-2014	xDrive35i	<b>US6681</b>	3.2L V6 196 CID	1978-1979		<b>US1018</b>
4.4L V8 4395cc	2008-2009	xDrive50i	<b>US6708</b>	3.2L V6 196 CID	1978-1979	High performance	<b>US1018H</b>
4.4L V8 4395cc	2010-2011	ActiveHybrid, M, xDrive50i	<b>US6708</b>	3.3L V6 204 CID	1989	Custom, Estate Wagon, Limited	<b>US5050</b>
4.4L V8 4395cc	2012	M, xDrive50i	<b>US6708</b>	3.3L V6 204 CID	1990	Custom, Limited	<b>US5050</b>
4.4L V8 4395cc	2013	M	<b>US6708</b>	3.3L V6 204 CID	1991-1993	Custom, Limited, Special	<b>US5050</b>
4.4L V8 4395cc	2013	xDrive50i; (N63B44A)	<b>US6708</b>	3.8L V6 231 CID	1975-1977		<b>US1018</b>
4.4L V8 4395cc	2014	M, xDrive50i	<b>US6708</b>	3.8L V6 231 CID	1975-1977	High performance	<b>US1018H</b>
4.4L V8 4395cc	2015-2017	xDrive50i	<b>US6708</b>	3.8L V6 231 CID	1979	High performance	<b>US1018H</b>
4.4L V8 4395cc 268 CID	2014	M, xDrive50i	<b>US6708</b>	3.8L V6 3800cc 231 CID	1978-1979		<b>US1018</b>
<b>Z3</b>				3.8L V6 3800cc 231 CID	1978-1979	High performance	<b>US1018H</b>
1.9L L4 1895cc	1996-1998	Roadster	<b>US9275</b>	3.8L V6 3800cc 231 CID	1980-1981	Base, Estate, Limited, Sport	<b>US1018</b>
1.9L L4 1895cc 116 CID	1999	Mexican Application	<b>US9275</b>	3.8L V6 3800cc 231 CID	1980-1981	Base, Estate, Limited, Sport; High performance	<b>US1018H</b>
2.0L L6 1991cc 121 CID	2000	Mexican Application	<b>US9261</b>	3.8L V6 3800cc 231 CID	1984	Custom, Estate, Limited, Olympia Limited, T-Type	<b>US5028</b>
2.2L L6 2171cc 132 CID	2001	Mexican Application	<b>US9261</b>	3.8L V6 3800cc 231 CID	1985	Custom, Estate Wagon, Limited, T-Type	<b>US5028</b>
2.5L L6 2494cc 152 CID	1999-2002	Roadster	<b>US9261</b>	3.8L V6 3800cc 231 CID	1986	Custom, Estate Wagon, Limited, T-Type	<b>US5050</b>
2.8L L6 2793cc	1997-1998	Roadster	<b>US9261</b>	3.8L V6 3800cc 231 CID	1987-1988	Custom, Estate Wagon, Limited	<b>US5050</b>
2.8L L6 2793cc	1999-2000	Coupe, Roadster	<b>US9261</b>	4.3L V6 260 CID	1982-1983	Custom, Limited; W/O Pulley	<b>US5014</b>
3.0L L6 2979cc	2001-2002	Coupe, Roadster	<b>US9261</b>	4.3L V6 260 CID	1982-1983	Custom, Limited; Includes pulley	<b>US5014P</b>
3.2L L6 3152cc	1998	M Roadster	<b>US9261</b>	4.3L V6 260 CID	1984	Custom, Estate, Limited, Olympia Limited; W/O Pulley	<b>US5014</b>
3.2L L6 3152cc	1999-2000	M Coupe, M Roadster	<b>US9261</b>	4.3L V6 260 CID	1984	Custom, Estate, Limited, Olympia Limited; Includes pulley	<b>US5014P</b>
<b>Z4</b>				4.3L V6 260 CID	1985	Custom, Estate Wagon, Limited; W/O Pulley	<b>US5014P</b>
2.0L L4 1997cc 122 CID	2012-2016	sDrive28i	<b>US8135</b>	4.3L V6 260 CID	1985	Custom, Estate Wagon, Limited; Includes pulley	<b>US5014P</b>
2.5L L6 2494cc 152 CID	2003-2005	2.5i	<b>US9261</b>	4.3L V8 265 CID	1980	Base, Estate, Limited	<b>US975</b>
2.5L L6 2494cc 152 CID	2007-2009	Mexican Application	<b>US9261</b>	4.3L V8 265 CID	1981	Base, Estate, Limited, Sport	<b>US975</b>
3.0L L6 2979cc	2003-2005	3.0i	<b>US9261</b>	4.9L V8 301 CID	1979		<b>US975</b>
3.0L L6 2979cc	2009-2010	sDrive35i	<b>US6681</b>	4.9L V8 301 CID	1980	Base, Estate, Limited, Sport	<b>US975</b>
3.0L L6 2979cc	2011-2016	sDrive35i, sDrive35is	<b>US6681</b>	5.0L V8 305 CID	1977-1979		<b>US1121</b>
3.0L L6 2979cc 182 CID	2011-2013	sDrive35i	<b>US6681</b>	5.0L V8 305 CID	1977-1979	High performance	<b>US1121H</b>
3.0L L6 2996cc	2008	Coupe 3.0si	<b>US6680</b>	5.0L V8 305 CID	1980	Base, Estate, Limited	<b>US1121</b>
3.0L L6 2996cc	2009-2011	sDrive30i	<b>US6680</b>	5.0L V8 305 CID	1980	Base, Estate, Limited; High performance	<b>US1121H</b>
<b>Z8</b>				5.0L V8 305 CID	1980	High performance	<b>US1018</b>
4.8L V8 4837cc	2003	Alpina	<b>US9465</b>	5.7L V8 350 CID	1975-1976		<b>US1018H</b>
<b>BUICK</b>				5.7L V8 350 CID	1975-1978	High performance	<b>US1100</b>
<b>APOLLO</b>				5.7L V8 350 CID	1975-1979	Exc.Air Cond	<b>US1100</b>
4.3L V8 260 CID	1975	Exc.Air Cond	<b>US1100</b>	5.7L V8 350 CID	1975-1979	Air Cond	<b>US1120</b>
4.3L V8 260 CID	1975	Air Cond	<b>US1120</b>	5.7L V8 350 CID	1975-1979	Air Cond, High performance	<b>US1120H</b>
4.3L V8 260 CID	1975	Air Cond, High performance	<b>US1120H</b>	5.7L V8 350 CID	1979	High performance	<b>US1121H</b>
5.7L V8 350 CID	1975		<b>US1018</b>	5.7L V8 350 CID	1981	Base, Estate, Limited; Exc.Air Cond	<b>US1100</b>
5.7L V8 350 CID	1975	High performance	<b>US1018H</b>	5.7L V8 350 CID	1981	Base, Estate, Limited; With air cond.	<b>US1120</b>
5.7L V8 350 CID	1975	Exc.Air Cond	<b>US1100</b>	5.7L V8 350 CID	1981	Base, Estate, Limited; High performance, With air cond.	<b>US1120H</b>
5.7L V8 350 CID	1975	Air Cond	<b>US1120</b>	6.6L V8 403 CID	1977	Exc.Air Cond	<b>US1100</b>
5.7L V8 350 CID	1975	Air Cond, High performance	<b>US1120H</b>	6.6L V8 403 CID	1977	Air Cond	<b>US1120</b>
<b>CASCADA</b>				6.6L V8 403 CID	1977	Air Cond, High performance	<b>US1120H</b>
1.6L L4 1598cc 98 CID	2016	Base, Premium	<b>US8155</b>	<b>COMMERCIAL CHASSIS</b>			
1.6L L4 1598cc 98 CID	2016	Base, Premium; Pump only	<b>US8155</b>	5.0L V8 305 CID	1991	Base	<b>US5051</b>
1.6L L4 1598cc 98 CID	2017	Base, Premium, Sport Touring	<b>US8155</b>	5.7L V8 350 CID	1992-1993	Base	<b>US5051</b>
1.6L L4 1598cc 98 CID	2017	Base, Premium, Sport Touring; Pump only	<b>US8155</b>	5.7L V8 350 CID	1994-1996	Base	<b>US5069</b>
<b>CENTURION</b>				<b>ELECTRA</b>			
7.5L V8 7456cc 455 CID	1971-1972		<b>US821</b>	3.0L V6 181 CID	1985	Limited	<b>US5028</b>
<b>CENTURY</b>				3.8L V6 3800cc 231 CID	1985	Limited, Park Avenue, T-Type	<b>US5028</b>
2.2L L4 2190cc 134 CID	1993	Custom, Limited, Special	<b>US5032</b>	3.8L V6 3800cc 231 CID	1986-1988	Limited, Park Avenue, T-Type	<b>US5050</b>
2.2L L4 2190cc 134 CID	1994	Custom, Special	<b>US5032</b>	3.8L V6 3800cc 231 CID	1989-1990	Limited, Park Avenue, Park Avenue Ultra, T-Type	<b>US5050</b>
2.2L L4 2190cc 134 CID	1995	Special	<b>US5032</b>	4.1L V6 252 CID	1980-1984	Limited, Park Avenue	<b>US1018</b>
2.2L L4 2190cc 134 CID	1996	Limited, Special	<b>US5032</b>	4.1L V6 252 CID	1980-1984	Limited, Park Avenue; High performance	<b>US1018H</b>
2.5L L4 2474cc 151 CID	1982-1983	Custom, Limited	<b>US5000</b>	4.3L V6 260 CID	1985	Limited, Park Avenue; W/O Pulley	<b>US5014</b>
2.5L L4 2474cc 151 CID	1982-1983	Custom, Limited; Includes pulley	<b>US5000P</b>	4.3L V6 260 CID	1985	Limited, Park Avenue; Includes pulley	<b>US5014P</b>
2.5L L4 2474cc 151 CID	1984	Custom, Estate, Limited, Olympia Limited	<b>US5000</b>	4.9L V8 301 CID	1980	Estate Wagon	<b>US975</b>
2.5L L4 2474cc 151 CID	1984	Custom, Estate, Limited, Olympia Limited; Includes pulley	<b>US5000P</b>	5.0L V8 307 CID	1981-1984	Estate Wagon, Limited, Park Avenue; Exc.Air Cond	<b>US1100</b>
2.5L L4 2474cc 151 CID	1985	Custom, Estate Wagon, Limited; Includes pulley	<b>US5000P</b>	5.0L V8 307 CID	1981-1984	Estate Wagon, Limited, Park Avenue; With air cond.	<b>US1120</b>
2.5L L4 2474cc 151 CID	1985-1986	Custom, Estate Wagon, Limited	<b>US5000</b>	5.0L V8 307 CID	1981-1984	Estate Wagon, Limited, Park Avenue; High performance, With air cond.	<b>US1120H</b>
2.5L L4 2474cc 151 CID	1986	Custom, Estate Wagon; Includes pulley	<b>US5000P</b>	5.0L V8 307 CID	1985	Estate Wagon; Exc.Air Cond	<b>US1100</b>
2.5L L4 2474cc 151 CID	1987-1989	Custom, Estate Wagon, Limited	<b>US5041</b>	5.0L V8 307 CID	1985	Estate Wagon; With air cond.	<b>US1120</b>
2.5L L4 2474cc 151 CID	1990	Custom, Limited	<b>US5041</b>	5.0L V8 307 CID	1985	Estate Wagon; High performance, With air cond.	<b>US1120H</b>
2.5L L4 2474cc 151 CID	1991-1992	Custom, Limited, Special	<b>US5041</b>	5.0L V8 307 CID	1986-1989	Estate Wagon	<b>US1120</b>
2.8L V6 173 CID	1986	Custom, Estate Wagon, Limited	<b>US5001</b>	5.0L V8 307 CID	1986-1989	Estate Wagon; High performance	<b>US1120H</b>
2.8L V6 173 CID	1987-1988	Custom, Estate Wagon, Limited	<b>US5033</b>	5.7L V8 350 CID	1976-1979	Exc.Air Cond	<b>US1100</b>
2.8L V6 173 CID	1989	Custom, Limited	<b>US5033</b>	5.7L V8 350 CID	1976-1979	Air Cond	<b>US1120</b>
3.0L V6 181 CID	1982	Custom, Limited	<b>US5028</b>	5.7L V8 350 CID	1976-1979	Air Cond, High performance	<b>US1120H</b>
3.0L V6 181 CID	1983	Custom, Limited, T-Type	<b>US5028</b>	5.7L V8 350 CID	1977-1979	High performance	<b>US1018</b>
3.0L V6 181 CID	1984	Custom, Estate, Limited, Olympia Limited, T-Type	<b>US5028</b>	5.7L V8 350 CID	1977-1979	High performance	<b>US1018H</b>
3.0L V6 181 CID	1985	Custom, Estate Wagon, Limited	<b>US5028</b>	5.7L V8 350 CID	1980	Estate Wagon, Limited, Park Avenue	<b>US1018</b>
3.1L V6 189 CID	1994-1995	Custom, Special	<b>US5033</b>	5.7L V8 350 CID	1980	Estate Wagon, Limited, Park Avenue; High performance	<b>US1018H</b>
3.1L V6 189 CID	1996	Custom, Limited, Special	<b>US5033</b>	5.7L V8 350 CID	1980	Estate Wagon, Limited, Park Avenue; High performance	<b>US1018H</b>
3.1L V6 189 CID	1997-2002	Custom, Limited	<b>US5033</b>				
3.1L V6 189 CID	2003	Custom	<b>US5033</b>				
3.1L V6 189 CID	2004	Custom, Limited	<b>US5033</b>				
3.1L V6 189 CID	2005	Custom, Limited, Special Edition	<b>US5033</b>				



Engine	Years	Application Description	USMW	Engine	Years	Application Description	USMW
<b>BUICK (cont'd.)</b>				<b>BUICK (cont'd.)</b>			
<b>ELECTRA (cont'd.)</b>				<b>LESABRE</b>			
5.7L V8 350 CID	1980-1983	Estate Wagon, Limited, Park Avenue; Exc.Air Cond	US1100	3.0L V6 181 CID	1986	Custom, Limited	US5050
5.7L V8 350 CID	1980-1983	Estate Wagon, Limited, Park Avenue; With air cond.	US1120	3.8L V6 231 CID	1976-1977		US1018
5.7L V8 350 CID	1980-1983	Estate Wagon, Limited, Park Avenue; High performance, With air cond.	US1120H	3.8L V6 231 CID	1976-1977	High performance	US1018H
5.7L V8 350 CID	1984-1985	Estate Wagon; Exc.Air Cond	US1100	3.8L V6 3800cc 231 CID	1977-1979		US1018
5.7L V8 350 CID	1984-1985	Estate Wagon; With air cond.	US1120	3.8L V6 3800cc 231 CID	1977-1979	High performance	US1018H
5.7L V8 350 CID	1984-1985	Estate Wagon; High performance, With air cond.	US1120H	3.8L V6 3800cc 231 CID	1980-1981	Base, Limited, Sport	US1018
6.6L V8 403 CID	1977-1979	Exc.Air Cond	US1100	3.8L V6 3800cc 231 CID	1980-1981	Base, Limited, Sport; High performance	US1018H
6.6L V8 403 CID	1977-1979	Air Cond	US1120	3.8L V6 3800cc 231 CID	1982	Custom, Limited, Limited Edition F/E	US1018
6.6L V8 403 CID	1977-1979	Air Cond, High performance	US1120H	3.8L V6 3800cc 231 CID	1982	Custom, Limited, Limited Edition F/E; High performance	US1018H
7.0L V8 7047cc 430 CID	1967-1969		US821	3.8L V6 3800cc 231 CID	1983-1984	Custom, Limited	US1018
7.5L V8 455 CID	1975		US1045	3.8L V6 3800cc 231 CID	1985	Collector's Edition, Custom, Limited	US1018
7.5L V8 7456cc 455 CID	1970-1972		US821	3.8L V6 3800cc 231 CID	1985	Collector's Edition, Custom, Limited; High performance	US1018H
<b>ENCLAVE</b>				3.8L V6 3800cc 231 CID	1986	Custom, Limited	US5050
3.6L V6 3564cc 217 CID	2008-2011	CX, CXL	US8932	3.8L V6 3800cc 231 CID	1987	Base, Custom, Limited, T-Type	US5050
3.6L V6 3564cc 217 CID	2012-2013	Base	US8932	3.8L V6 3800cc 231 CID	1988-1991	Base, Custom, Limited	US5050
3.6L V6 3564cc 217 CID	2015-2017	Convenience, Leather, Premium	US8932	3.8L V6 3800cc 231 CID	1992-1995	Custom, Limited	US5050
<b>ENCORE</b>				3.8L V6 3800cc 231 CID	1996-2005	Custom, Limited	US5075
1.4L L4 1364cc 83 CID	2013	Base	US6662	4.1L V6 252 CID	1980	Base, Limited	US1018
1.4L L4 1364cc 83 CID	2013	Base; (B), (LUV)	US6662	4.1L V6 252 CID	1980	Base, Limited; High performance	US1018H
1.4L L4 1364cc 83 CID	2014	Base, Convenience, Leather; (B), (LUV)	US6662	4.1L V6 252 CID	1981	Base, Limited, Sport	US1018
1.4L L4 1364cc 83 CID	2014	Premium; (B), (LUV), FI	US6662	4.1L V6 252 CID	1981	Base, Limited, Sport; High performance	US1018H
1.4L L4 1364cc 83 CID	2014-2016	Base, Convenience, Leather, Premium	US6662	4.1L V6 252 CID	1982	Custom, Limited, Limited Edition F/E	US1018
1.4L L4 1364cc 83 CID	2017	Base, Essence, Preferred, Preferred II, Premium, Sport Touring	US6662	4.1L V6 252 CID	1982	Custom, Limited, Limited Edition F/E; High performance	US1018H
1.4L L4 1399cc 85 CID	2016	Sport Touring	US8147	4.1L V6 252 CID	1983-1984	Custom, Limited	US1018
1.4L L4 1399cc 85 CID	2016	Sport Touring; Pump only	US8147	4.1L V6 252 CID	1983-1984	Custom, Limited; High performance	US1018H
1.4L L4 1399cc 85 CID	2017	Essence, Preferred II, Premium, Sport Touring	US8147	4.9L V8 300 CID	1965		US855
1.4L L4 1399cc 85 CID	2017	Essence, Preferred II, Premium, Sport Touring; Pump only	US8147	4.9L V8 301 CID	1977-1979		US975
<b>ENVISION</b>				4.9L V8 301 CID	1980	Base, Limited	US975
2.0L L4 1998cc 122 CID	2016-2017	Premium	US8102	4.9L V8 301 CID	1980		US975
2.5L L4 2457cc 153 CID	2017	Base, Essence, Preferred	US8102	4.9L V8 4917cc 300 CID	1964-1965		US855
<b>ESTATE WAGON</b>				5.0L V8 305 CID	1978		US1121
4.9L V8 301 CID	1980	Base	US975	5.0L V8 305 CID	1978	High performance	US1121H
4.9L V8 4917cc 300 CID	1964		US855	5.0L V8 307 CID	1981	Base, Limited, Sport; Exc.Air Cond	US1100
5.0L V8 307 CID	1981-1983	Base; Exc.Air Cond	US1100	5.0L V8 307 CID	1981	Base, Limited, Sport; With air cond.	US1120
5.0L V8 307 CID	1981-1983	Base; With air cond.	US1120	5.0L V8 307 CID	1981	Base, Limited, Sport; High performance, With air cond.	US1120H
5.0L V8 307 CID	1981-1983	Base; High performance, With air cond.	US1120H	5.0L V8 307 CID	1982	Custom, Limited, Limited Edition F/E; Exc.Air Cond	US1100
5.7L V8 350 CID	1970		US855	5.0L V8 307 CID	1982	Custom, Limited, Limited Edition F/E; With air cond.	US1120
5.7L V8 350 CID	1977-1979	Exc.Air Cond	US1100	5.0L V8 307 CID	1982	Custom, Limited, Limited Edition F/E; High performance, With air cond.	US1120H
5.7L V8 350 CID	1977-1979	Air Cond	US1120	5.0L V8 307 CID	1983-1984	Custom, Limited; Exc.Air Cond	US1100
5.7L V8 350 CID	1977-1979	Air Cond, High performance	US1120H	5.0L V8 307 CID	1983-1984	Custom, Limited; With air cond.	US1120
5.7L V8 350 CID	1980	Base	US1018	5.0L V8 307 CID	1983-1984	Custom, Limited; High performance, With air cond.	US1120H
5.7L V8 350 CID	1980	Base; High performance	US1018H	5.0L V8 307 CID	1985	Collector's Edition, Custom, Estate Wagon, Limited; Exc.Air Cond	US1100
5.7L V8 350 CID	1980-1983	Base; Exc.Air Cond	US1100	5.0L V8 307 CID	1985	Collector's Edition, Custom, Estate Wagon, Limited; With air cond.	US1120
5.7L V8 350 CID	1980-1983	Base; With air cond.	US1120	5.0L V8 307 CID	1985	Collector's Edition, Custom, Estate Wagon, Limited; High performance, With air cond.	US1120H
5.7L V8 350 CID	1980-1983	Base; High performance, With air cond.	US1120H	5.0L V8 307 CID	1985	Collector's Edition, Custom, Estate Wagon, Limited; High performance, With air cond.	US1120H
5.7L V8 5736cc 350 CID	1970		US855	5.0L V8 307 CID	1986-1990	Estate Wagon	US1120
6.6L V8 403 CID	1977-1979	Exc.Air Cond	US1100	5.0L V8 307 CID	1986-1990	Estate Wagon; High performance	US1120H
6.6L V8 403 CID	1977-1979	Air Cond	US1120	5.7L V8 350 CID	1968-1970		US855
6.6L V8 403 CID	1977-1979	Air Cond, High performance	US1120H	5.7L V8 350 CID	1975	W/O AIR	US1018
7.5L V8 455 CID	1975		US1045	5.7L V8 350 CID	1975-1979	High performance	US1018H
7.5L V8 7456cc 455 CID	1970-1972		US821	5.7L V8 350 CID	1975-1979	Exc.Air Cond	US1100
<b>GS</b>				5.7L V8 350 CID	1975-1979	Air Cond	US1120
5.7L V8 350 CID	1970		US855	5.7L V8 350 CID	1975-1979	Air Cond, High performance	US1120H
5.7L V8 5736cc 350 CID	1970		US855	5.7L V8 350 CID	1976		US1018
<b>GS 350</b>				5.7L V8 350 CID	1979		US1018
5.7L V8 350 CID	1968-1969		US855	5.7L V8 350 CID	1980	Base, Limited	US1018
5.7L V8 5736cc 350 CID	1968-1969		US855	5.7L V8 350 CID	1980	Base, Limited; High performance	US1018H
<b>LACROSSE</b>				5.7L V8 350 CID	1980	Base, Limited; Exc.Air Cond	US1100
2.4L L4 2384cc 145 CID	2010	CX	US5092	5.7L V8 350 CID	1980	Base, Limited; With air cond.	US1120
2.4L L4 2384cc 145 CID	2011	CX, CXL	US5092	5.7L V8 350 CID	1980	Base, Limited; High performance, With air cond.	US1120H
2.4L L4 2384cc 145 CID	2012	Base, Convenience, Leather	US5092	5.7L V8 350 CID	1980	Base, Limited; High performance, With air cond.	US1120H
2.4L L4 2384cc 145 CID	2013-2014	Base	US5092	5.7L V8 350 CID	1981	Base, Limited, Sport; Exc.Air Cond	US1100
2.4L L4 2384cc 145 CID	2015-2016	Base, Leather	US5092	5.7L V8 350 CID	1981	Base, Limited, Sport; With air cond.	US1120
3.0L V6 182 CID	2010	CX, CXL	US8932	5.7L V8 350 CID	1981	Base, Limited, Sport; High performance, With air cond.	US1120H
3.6L V6 222 CID	2017	Base, Essence, Preferred, Premium	US8148	5.7L V8 350 CID	1982	Custom, Limited, Limited Edition F/E; Exc.Air Cond	US1100
3.6L V6 3564cc 217 CID	2005-2008	CXS	US8932	5.7L V8 350 CID	1982	Custom, Limited, Limited Edition F/E; With air cond.	US1120
3.6L V6 3564cc 217 CID	2010	CXS	US8932	5.7L V8 350 CID	1982	Custom, Limited, Limited Edition F/E; With air cond.	US1120
3.6L V6 3564cc 217 CID	2011	CX, CXL, CXS	US8932	5.7L V8 350 CID	1982	Custom, Limited, Limited Edition F/E; High performance, With air cond.	US1120H
3.6L V6 3564cc 217 CID	2012	Base, Convenience, Leather, Premium, Touring	US8932	5.7L V8 350 CID	1983-1984	Custom, Limited; Exc.Air Cond	US1100
3.6L V6 3564cc 217 CID	2013	Base	US8932	5.7L V8 350 CID	1983-1984	Custom, Limited; With air cond.	US1120
3.6L V6 3564cc 217 CID	2015	Base, Leather, Premium	US8932	5.7L V8 350 CID	1983-1984	Custom, Limited; High performance, With air cond.	US1120H
3.6L V6 3564cc 217 CID	2016	Base, Leather, Premium, Sport Touring	US8932	5.7L V8 350 CID	1985	Collector's Edition, Custom, Estate Wagon, Limited; Exc.Air Cond	US1100
3.8L V6 3800cc 231 CID	2005-2009	CX, CXL	US5075				
5.3L V8 5328cc 325 CID	2008-2009	Super	US6154				

WATER PUMPS



# WATER PUMP APPLICATION GUIDE



Engine	Years	Application Description	USMW	Engine	Years	Application Description	USMW
<b>BUICK (cont'd.)</b>				<b>BUICK (cont'd.)</b>			
<b>LESABRE (cont'd.)</b>				<b>REGAL (cont'd.)</b>			
5.7L V8 350 CID	1985	Collector's Edition, Custom, Estate Wagon, Limited; With air cond.	US1120	3.8L V6 3800cc 231 CID	1999	GS, LS	US5075
5.7L V8 350 CID	1985	Collector's Edition, Custom, Estate Wagon, Limited; High performance, With air cond.	US1120H	3.8L V6 3800cc 231 CID	2000	GS, GSE, LS, LSE	US5075
5.7L V8 5736cc 350 CID	1968-1970		US855	3.8L V6 3800cc 231 CID	2001-2004	GS, LS	US5075
6.6L V8 400 CID	1975	Exc.Air Cond	US1100	4.1L V6 252 CID	1982	Base, Estate Wagon, Limited, Limited Turbo	US1018
6.6L V8 400 CID	1975	Air Cond	US1120	4.1L V6 252 CID	1982	Base, Estate Wagon, Limited, Limited Turbo; High performance	US1018H
6.6L V8 400 CID	1975	Air Cond, High performance	US1120H	4.1L V6 252 CID	1983	Base, Estate Wagon, Limited	US1018
6.6L V8 403 CID	1977-1978	Exc.Air Cond	US1100	4.1L V6 252 CID	1983	Base, Estate Wagon, Limited; High performance	US1018H
6.6L V8 403 CID	1977-1978	Air Cond	US1120	4.1L V6 252 CID	1984	Base, Limited	US1018
6.6L V8 403 CID	1977-1978	Air Cond, High performance	US1120H	4.1L V6 252 CID	1984	Base, Limited; High performance	US1018H
7.5L V8 455 CID	1975		US1045	4.3L V6 260 CID	1982-1984	Base, Limited	US5012
7.5L V8 7456cc 455 CID	1970-1972		US821	4.3L V8 265 CID	1980-1981	Base, Limited	US975
<b>LUCERNE</b>				<b>RENDZVOUS</b>			
3.8L V6 3800cc 231 CID	2006-2008	CX, CXL	US5075	3.4L V6 207 CID	2002-2003	CX, CXL, CXL Plus, CX Plus	US5033
3.9L V6 3880cc 237 CID	2009	CX, CXL	US6020	3.4L V6 207 CID	2004	CX, CXL	US5033
3.9L V6 3880cc 237 CID	2010	CX, CXL, CXL Special Edition	US6020	3.4L V6 207 CID	2005	CX, CXL, CX Plus	US5033
3.9L V6 3880cc 237 CID	2011	CX, CXL	US6020	3.5L V6 213 CID	2006-2007	CX, CXL	US5033
4.6L V8 281 CID	2006-2007	CXL, CXS	US8956	3.6L V6 3564cc 217 CID	2004	CXL, Ultra	US8932
4.6L V8 281 CID	2008	CXL, CXS, Super	US8956	3.6L V6 3564cc 217 CID	2005	CXL Plus, Ultra	US8932
4.6L V8 281 CID	2009-2011	Super	US8956	3.6L V6 3564cc 217 CID	2006	CX, CXL	US8932
<b>OPEL</b>				<b>RIVIERA</b>			
1.7L L4 1700cc 104 CID	1959-1964	Mexican Application	US1061	3.8L V6 3800cc 231 CID	1979		US1018
2.1L L4 2100cc 128 CID	1965-1972	Mexican Application	US1061	3.8L V6 3800cc 231 CID	1979	High performance	US1018H
<b>PARK AVENUE</b>				3.8L V6 3800cc 231 CID	1980	Base, S	US1018
3.8L V6 3800cc 231 CID	1991-1995	Base, Ultra	US5050	3.8L V6 3800cc 231 CID	1980	Base, S; High performance	US1018H
3.8L V6 3800cc 231 CID	1996-2005	Base, Ultra	US5075	3.8L V6 3800cc 231 CID	1981	Base, T-Type	US1018
<b>RAINIER</b>				3.8L V6 3800cc 231 CID	1981	Base, T-Type; High performance	US1018H
4.2L L6 256 CID	2004-2005	CXL, CXL Plus	US5097	3.8L V6 3800cc 231 CID	1982-1983	T-Type	US1018
4.2L L6 256 CID	2006-2007	CXL	US5097	3.8L V6 3800cc 231 CID	1982-1983	T-Type; High performance	US1018H
5.3L V8 5328cc 325 CID	2004-2005	CXL, CXL Plus	US64	3.8L V6 3800cc 231 CID	1984-1985	Base, Luxury, T-Type	US1018
5.3L V8 5328cc 325 CID	2004-2005	CXL, CXL Plus; Includes thermostat and thermostat housing	US64-T	3.8L V6 3800cc 231 CID	1984-1985	Base, Luxury, T-Type; High performance	US1018H
5.3L V8 5328cc 325 CID	2006	CXL	US64	3.8L V6 3800cc 231 CID	1986-1989	Luxury, T-Type	US5050
5.3L V8 5328cc 325 CID	2006	CXL; Includes thermostat and thermostat housing	US64-T	3.8L V6 3800cc 231 CID	1990-1993	Luxury	US5050
5.3L V8 5328cc 325 CID	2007	CXL	US6009	3.8L V6 3800cc 231 CID	1995	Base	US5050
5.3L V8 5328cc 325 CID	2007	CXL; Includes thermostat and thermostat housing	US6009-T	3.8L V6 3800cc 231 CID	1996-1999	Base	US5075
<b>REATTA</b>				4.1L V6 252 CID	1981	Base, T-Type	US1018
3.8L V6 3800cc 231 CID	1988-1991	Base	US5050	4.1L V6 252 CID	1981	Base, T-Type; High performance	US1018H
<b>REGAL</b>				4.1L V6 252 CID	1982	Base, Limited Edition	US1018
2.0L L4 1998cc 122 CID	2011	CXL	US5092	4.1L V6 252 CID	1982	Base, Limited Edition; High performance	US1018H
2.0L L4 1998cc 122 CID	2012-2013	GS, Turbo	US5092	4.1L V6 252 CID	1983	Base, Luxury, XX Anniversary Edition	US1018
2.0L L4 1998cc 122 CID	2014	GS, Turbo; Pump only	US8102	4.1L V6 252 CID	1983	Base, Luxury, XX Anniversary Edition; High performance	US1018H
2.0L L4 1998cc 122 CID	2015	Base, GS, Premium	US8102	4.1L V6 252 CID	1984	Base, Luxury	US1018
2.0L L4 1998cc 122 CID	2015	Base, GS, Premium; Pump only	US8102	4.1L V6 252 CID	1984	Base, Luxury; High performance	US1018H
2.0L L4 1998cc 122 CID	2016-2017	Base, GS, Premium, Sport Touring	US8102	5.0L V8 307 CID	1980	Base, S; Exc.Air Cond	US1100
2.4L L4 2384cc 145 CID	2011	CXL	US5092	5.0L V8 307 CID	1980	Base, S; With air cond.	US1120
2.4L L4 2384cc 145 CID	2012-2014	Base	US5092	5.0L V8 307 CID	1980	Base, S; High performance, With air cond.	US1120H
2.4L L4 2384cc 145 CID	2015-2016	Base, Premium	US5092	5.0L V8 307 CID	1981	Base, T-Type; Exc.Air Cond	US1100
2.4L L4 2384cc 145 CID	2017	Base	US5092	5.0L V8 307 CID	1981	Base, T-Type; With air cond.	US1120
2.8L V6 173 CID	1988-1989	Custom, Limited	US5033	5.0L V8 307 CID	1981	Base, T-Type; High performance, With air cond.	US1120H
3.1L V6 189 CID	1989	Custom, Gran Sport, Limited	US5033	5.0L V8 307 CID	1982	Base, Limited Edition; Exc.Air Cond	US1100
3.1L V6 189 CID	1990-1993	Custom, Limited	US5033	5.0L V8 307 CID	1982	Base, Limited Edition; With air cond.	US1120
3.1L V6 189 CID	1994-1996	Custom	US5033	5.0L V8 307 CID	1982	Base, Limited Edition; High performance, With air cond.	US1120H
3.2L V6 196 CID	1978-1979		US1018	5.0L V8 307 CID	1983	Base, Luxury, XX Anniversary Edition; Exc.Air Cond	US1100
3.2L V6 196 CID	1978-1979	High performance	US1018H	5.0L V8 307 CID	1983	Base, Luxury, XX Anniversary Edition; High performance, With air cond.	US1120H
3.8L V6 231 CID	1975-1977		US1018	5.0L V8 307 CID	1983	Base, Limited Edition; With air cond.	US1120
3.8L V6 231 CID	1979	High performance	US1018H	5.0L V8 307 CID	1983	Base, Limited Edition; High performance, With air cond.	US1120H
3.8L V6 231 CID	1979	High performance	US1018H	5.0L V8 307 CID	1983	Base, Limited Edition; High performance, With air cond.	US1120H
3.8L V6 3800cc 231 CID	1978-1979	High performance	US1018H	5.0L V8 307 CID	1983	Base, Limited Edition; High performance, With air cond.	US1120H
3.8L V6 3800cc 231 CID	1978-1979	Base, Limited, Sport	US1018	5.0L V8 307 CID	1983	Base, Limited Edition; High performance, With air cond.	US1120H
3.8L V6 3800cc 231 CID	1980-1981	Base, Limited, Sport; High performance	US1018H	5.0L V8 307 CID	1983	Base, Limited Edition; High performance, With air cond.	US1120H
3.8L V6 3800cc 231 CID	1980-1981	Base, Estate Wagon, Limited, Sport	US1018	5.0L V8 307 CID	1983	Base, Limited Edition; High performance, With air cond.	US1120H
3.8L V6 3800cc 231 CID	1982	Base, Estate Wagon, Limited, Sport; High performance	US1018H	5.0L V8 307 CID	1983	Base, Limited Edition; High performance, With air cond.	US1120H
3.8L V6 3800cc 231 CID	1982	Base, Estate Wagon, Limited, T-Type	US1018	5.0L V8 307 CID	1983	Base, Limited Edition; High performance, With air cond.	US1120H
3.8L V6 3800cc 231 CID	1983	Base, Estate Wagon, Limited, T-Type; High performance	US1018H	5.0L V8 307 CID	1983	Base, Limited Edition; High performance, With air cond.	US1120H
3.8L V6 3800cc 231 CID	1984-1986	Base, Grand National, Limited, T-Type	US1018	5.0L V8 307 CID	1983	Base, Limited Edition; High performance, With air cond.	US1120H
3.8L V6 3800cc 231 CID	1984-1986	Base, Grand National, Limited, T-Type; High performance	US1018H	5.0L V8 307 CID	1983	Base, Limited Edition; High performance, With air cond.	US1120H
3.8L V6 3800cc 231 CID	1987	Base, GNX, Grand National, Limited	US1018	5.0L V8 307 CID	1983	Base, Limited Edition; High performance, With air cond.	US1120H
3.8L V6 3800cc 231 CID	1987	Base, GNX, Grand National, Limited; High performance	US1018H	5.0L V8 307 CID	1983	Base, Limited Edition; High performance, With air cond.	US1120H
3.8L V6 3800cc 231 CID	1990-1995	Custom, Gran Sport, Limited	US5050	5.0L V8 307 CID	1983	Base, Limited Edition; High performance, With air cond.	US1120H
3.8L V6 3800cc 231 CID	1996	Custom, Gran Sport, Limited, Olympic Gold Edition	US5075	5.0L V8 307 CID	1983	Base, Limited Edition; High performance, With air cond.	US1120H
3.8L V6 3800cc 231 CID	1997	GS, LS	US5075	5.0L V8 307 CID	1983	Base, Limited Edition; High performance, With air cond.	US1120H
3.8L V6 3800cc 231 CID	1998	25th Anniversary Edition, GS, LS	US5075	5.0L V8 307 CID	1984-1985	Base, Limited Edition; High performance, With air cond.	US1120H

Engine	Years	Application Description	USMW	Engine	Years	Application Description	USMW
<b>BUICK (cont'd.)</b>				<b>BUICK (cont'd.)</b>			
<b>RIVIERA (cont'd.)</b>				<b>SKYLARK (cont'd.)</b>			
5.0L V8 307 CID	1984-1985	Base, Luxury; With air cond.	US1120	3.1L V6 189 CID	1998	Custom	US5033
5.0L V8 307 CID	1984-1985	Base, Luxury; High performance, With air cond.	US1120H	3.3L V6 204 CID	1989	Custom, Limited	US5050
5.7L V8 350 CID	1977-1979		US1018	3.3L V6 204 CID	1990	Custom, Gran Sport, Luxury Edition	US5050
5.7L V8 350 CID	1977-1979	High performance	US1018H	3.3L V6 204 CID	1991	Base, Custom, Gran Sport, Luxury Edition	US5050
5.7L V8 350 CID	1977-1979	Exc.Air Cond	US1100	3.3L V6 204 CID	1992	Custom, Gran Sport	US5050
5.7L V8 350 CID	1977-1979	Air Cond	US1120	3.3L V6 204 CID	1993	Custom, Gran Sport, Limited	US5050
5.7L V8 350 CID	1977-1979	Air Cond, High performance	US1120H	3.7L V6 3687cc 225 CID	1964-1967		US855
5.7L V8 350 CID	1980	Base, S; Exc.Air Cond	US1100	3.8L V6 231 CID	1975-1977		US1018
5.7L V8 350 CID	1980	Base, S; With air cond.	US1120	3.8L V6 231 CID	1975-1977	High performance	US1018H
5.7L V8 350 CID	1980	Base, S; High performance, With air cond.	US1120H	3.8L V6 3800cc 231 CID	1978		US1018
5.7L V8 350 CID	1981	Base; Exc.Air Cond	US1100	3.8L V6 3800cc 231 CID	1978-1979	High performance	US1018H
5.7L V8 350 CID	1981	Base; With air cond.	US1120	4.3L V8 260 CID	1975-1976	Exc.Air Cond	US1100
5.7L V8 350 CID	1981	Base; High performance, With air cond.	US1120H	4.3L V8 260 CID	1975-1976	Air Cond	US1120
5.7L V8 350 CID	1982	Base, Limited Edition; Exc.Air Cond	US1100	4.3L V8 260 CID	1975-1976	Air Cond, High performance	US1120H
5.7L V8 350 CID	1982	Base, Limited Edition; With air cond.	US1120	4.9L V8 301 CID	1977		US975
5.7L V8 350 CID	1982	Base, Limited Edition; High performance, With air cond.	US1120H	4.9L V8 4917cc 300 CID	1964-1967		US855
5.7L V8 350 CID	1983	Base, Luxury, XX Anniversary Edition; Exc.Air Cond	US1100	5.0L V8 305 CID	1977-1979		US1121
5.7L V8 350 CID	1983	Base, Luxury, XX Anniversary Edition; With air cond.	US1120	5.0L V8 305 CID	1977-1979	High performance	US1121H
5.7L V8 350 CID	1983	Base, Luxury, XX Anniversary Edition; High performance, With air cond.	US1120H	5.7L V8 350 CID	1968-1970		US855
5.7L V8 350 CID	1984-1985	Base, Luxury; Exc.Air Cond	US1100	5.7L V8 350 CID	1975-1976	Exc.Air Cond	US1018
5.7L V8 350 CID	1984-1985	Base, Luxury; With air cond.	US1120	5.7L V8 350 CID	1975-1977	Air Cond	US1100
5.7L V8 350 CID	1984-1985	Base, Luxury; High performance, With air cond.	US1120H	5.7L V8 350 CID	1975-1977	Air Cond, High performance	US1120H
6.6L V8 403 CID	1977-1978	Exc.Air Cond	US1100	5.7L V8 350 CID	1975-1978	High performance	US1018H
6.6L V8 403 CID	1977-1978	Air Cond	US1120	5.7L V8 350 CID	1978-1979		US1121
6.6L V8 403 CID	1977-1978	Air Cond, High performance	US1120H	5.7L V8 350 CID	1979	High performance	US1121H
7.0L V8 7047cc 430 CID	1967-1969		US821	5.7L V8 5736cc 350 CID	1968-1970		US855
7.5L V8 455 CID	1975		US1045	<b>SOMERSET</b>			
7.5L V8 7456cc 455 CID	1970-1972		US821	2.5L L4 2474cc 151 CID	1986	Custom, Limited, T-Type	US5000
<b>ROADMASTER</b>				2.5L L4 2474cc 151 CID	1986-1987	With Multi-Groove pulley	US5067
5.0L V8 305 CID	1991	Estate Wagon	US5051	2.5L L4 2474cc 151 CID	1987	Custom, Limited	US5000
5.7L V8 350 CID	1992-1993	Base, Estate Wagon, Limited	US5051	2.5L L4 2474cc 151 CID	1987	Custom, Limited; Includes pulley	US5000P
5.7L V8 350 CID	1994-1995	Base, Estate Wagon, Limited	US5069	3.0L V6 181 CID	1986	Custom, Limited, T-Type	US5050
5.7L V8 350 CID	1996	Collector's Edition, Estate Wagon Collector's Edition, Limited Collector's Edition	US5069	3.0L V6 181 CID	1987	Custom, Limited	US5050
<b>SKYHAWK</b>				<b>SOMERSET REGAL</b>			
1.8L L4 112 CID	1982	Custom, Limited	US5007	2.5L L4 2474cc 151 CID	1985	Base, Limited	US5000
1.8L L4 112 CID	1982	Custom, Limited	US5017	2.5L L4 2474cc 151 CID	1985	With Multi-Groove pulley	US5067
1.8L L4 112 CID	1983-1985	Custom, Limited, T-Type	US5017	3.0L V6 181 CID	1985	Base, Limited	US5050
1.8L L4 112 CID	1986	Custom, Limited, Sport, T-Type	US5017	<b>SPECIAL</b>			
2.0L L4 122 CID	1983-1985	Custom, Limited	US5007	3.7L V6 3687cc 225 CID	1964-1967		US855
2.0L L4 122 CID	1986	Custom, Limited, Sport	US5007	4.9L V8 4917cc 300 CID	1964-1967		US855
2.0L L4 122 CID	1987	Custom, Limited, Sport, T-Type	US5032	5.7L V8 5736cc 350 CID	1968-1969		US855
2.0L L4 122 CID	1987	Custom, Limited, Sport, T-Type	US5036	<b>SPORTWAGON</b>			
2.0L L4 122 CID	1988	Custom, SE	US5036	3.7L V6 3687cc 225 CID	1964		US855
2.0L L4 122 CID	1988-1989	Custom, SE	US5032	4.9L V8 4917cc 300 CID	1964-1965		US855
3.8L V6 231 CID	1975-1977		US1018	5.7L V8 5736cc 350 CID	1968-1970		US855
3.8L V6 231 CID	1975-1977	High performance	US1018H	<b>TERRAZA</b>			
3.8L V6 3800cc 231 CID	1978-1979		US1018	3.5L V6 213 CID	2005-2006	CX, CXL	US5033
3.8L V6 3800cc 231 CID	1978-1979	High performance	US1018H	3.9L V6 3880cc 237 CID	2006-2007	CX, CXL	US6020
3.8L V6 3800cc 231 CID	1980	Base, Designers' Accent Edition, Road Hawk, S	US1018	<b>VERANO</b>			
3.8L V6 3800cc 231 CID	1980	Base, Designers' Accent Edition, Road Hawk, S; High performance	US1018H	2.0L L4 1998cc 122 CID	2013	Premium, Turbo	US5092
<b>SKYLARK</b>				2.0L L4 1998cc 122 CID	2014-2016	Premium	US5092
2.3L L4 138 CID	1988-1989	Custom, Limited	US5043	2.4L L4 2384cc 145 CID	2012	Base	US5092
2.3L L4 138 CID	1990	Custom, Gran Sport, Luxury Edition	US5043	2.4L L4 2384cc 145 CID	2013-2015	Base, Convenience, Leather	US5092
2.3L L4 138 CID	1991	Base, Custom, Gran Sport, Luxury Edition	US5043	2.4L L4 2384cc 145 CID	2016	Base, Convenience, Leather, Sport Touring	US5092
2.3L L4 138 CID	1992	Custom	US5043	2.4L L4 2384cc 145 CID	2017	Base, Leather, Sport Touring	US5092
2.3L L4 138 CID	1993-1995	Custom, Limited	US5043	<b>WILDCAT</b>			
2.4L L4 2392cc 146 CID	1996	Custom, Limited, Olympic Gold Edition	US5076	7.0L V8 7047cc 430 CID	1967-1969		US821
2.4L L4 2392cc 146 CID	1997	Custom, Limited	US5076	7.5L V8 7456cc 455 CID	1970		US821
2.4L L4 2392cc 146 CID	1998	Custom	US5076	<b>CADILLAC</b>			
2.5L L4 2474cc 151 CID	1980-1982	Base, Limited, Sport	US5000	<b>60 SPECIAL</b>			
2.5L L4 2474cc 151 CID	1980-1982	Base, Limited, Sport; Includes pulley	US5000P	4.9L V8 300 CID	1993	Base	US5023
2.5L L4 2474cc 151 CID	1983-1985	Custom, Limited; Includes pulley	US5000P	<b>ALLANTE</b>			
2.5L L4 2474cc 151 CID	1983-1989	Custom, Limited	US5000	4.1L V8 250 CID	1987-1988	Base	US5023
2.5L L4 2474cc 151 CID	1986-1991	With Multi-Groove pulley	US5067	4.5L V8 273 CID	1989	Base	US5023
2.5L L4 2474cc 151 CID	1990-1991	Base, Custom, Gran Sport, Luxury Edition	US5000	4.5L V8 273 CID	1990-1992	Base, Value Leader	US5023
2.8L V6 173 CID	1980-1982	Base, Limited, Sport	US5001	4.6L V8 281 CID	1993	Base, Indianapolis 500 Pace Car, Value Leader	US5064
2.8L V6 173 CID	1983	Custom, Limited, Sport, T-Type	US5001	<b>ATS</b>			
2.8L V6 173 CID	1984	Custom, Limited, T-Type	US5001	2.0L L4 1998cc 122 CID	2013-2015	Base, Luxury, Performance, Premium; Pump only	US8102
2.8L V6 173 CID	1985	Custom, Limited	US5001	2.0L L4 1998cc 122 CID	2015-2016	Base, Luxury, Performance, Premium	US8102
3.0L V6 181 CID	1986-1988	Custom, Limited	US5050	2.0L L4 1998cc 122 CID	2017	Base, Luxury	US8102
3.1L V6 189 CID	1994-1995	Custom, Gran Sport, Limited	US5033	2.5L L4 2457cc 150 CID	2013-2015	Base, Luxury; Pump only	US8102
3.1L V6 189 CID	1996	Custom, Gran Sport, Limited, Olympic Gold Edition	US5033	2.5L L4 2457cc 150 CID	2015-2016	Base, Luxury	US8102
3.1L V6 189 CID	1997	Custom, Gran Sport, Limited	US5033	3.6L V6 222 CID	2016	Luxury, Performance, Premium	US8148
				3.6L V6 222 CID	2017	Premium Luxury, Premium Performance	US8148
				3.6L V6 3564cc 217 CID	2013	Luxury, Performance, Premium	US8932

WATER PUMPS



Engine	Years	Application Description	USMW
<b>CADILLAC (cont'd.)</b>			
<b>ATS (cont'd.)</b>			
3.6L V6 3564cc 217 CID	2015	Luxury, Performance, Premium	<b>US8932</b>
3.6L V6 3564cc 217 CID	2016-2017	V	<b>US8932</b>
<b>BROUGHAM</b>			
5.0L V8 305 CID	1991-1992	Base, d'Elegance	<b>US5049</b>
5.0L V8 305 CID	1991-1992	Base, d'Elegance; High performance	<b>US5049H</b>
5.0L V8 307 CID	1987-1990	Base, d'Elegance	<b>US1120</b>
5.0L V8 307 CID	1987-1990	Base, d'Elegance; High performance	<b>US1120H</b>
5.7L V8 350 CID	1990-1992	Base, d'Elegance	<b>US5049</b>
5.7L V8 350 CID	1990-1992	Base, d'Elegance; High performance	<b>US5049H</b>
<b>CALAIS</b>			
7.7L V8 472 CID	1968-1973		<b>US5003</b>
7.7L V8 7735cc 472 CID	1968-1973		<b>US5003</b>
<b>CATERA</b>			
3.0L V6 2962cc 181 CID	1997-1998	Base	<b>US5079</b>
3.0L V6 2962cc 181 CID	1999-2001	Base, Sport	<b>US5079</b>
<b>CIMARRON</b>			
1.8L L4 112 CID	1982	Base	<b>US5007</b>
2.0L L4 122 CID	1983	Base	<b>US5007</b>
2.0L L4 122 CID	1984-1986	Base, d'Oro	<b>US5007</b>
2.8L V6 173 CID	1985-1986	Base, d'Oro	<b>US5020</b>
2.8L V6 173 CID	1987-1988	Base	<b>US5033</b>
<b>COMMERCIAL CHASSIS</b>			
4.1L V8 250 CID	1985-1987	Base	<b>US5023</b>
4.3L V6 260 CID	1985	Base; W/O Pulley	<b>US5014</b>
4.3L V6 260 CID	1985	Base; Includes pulley	<b>US5014P</b>
4.5L V8 273 CID	1988-1990	Base	<b>US5023</b>
4.9L V8 300 CID	1991-1993	Base	<b>US5023</b>
5.7L V8 350 CID	1992-1993	Brougham	<b>US5049</b>
5.7L V8 350 CID	1992-1993	Brougham; High performance	<b>US5049H</b>
5.7L V8 350 CID	1994-1996	Base, Brougham	<b>US5069</b>
6.0L V8 368 CID	1980-1984	Base	<b>US5003</b>
6.4L V8 6392cc 390 CID	1963		<b>US670</b>
7.0L V8 7031cc 429 CID	1964-1965		<b>US670</b>
7.7L V8 7735cc 472 CID	1968-1973		<b>US5003</b>
<b>CT6</b>			
2.0L L4 1998cc 122 CID	2016-2017	Base, Luxury	<b>US8102</b>
3.0L V6 182 CID	2016-2017	Luxury, Platinum, Premium Luxury	<b>US8148</b>
3.6L V6 222 CID	2016-2017	Base, Luxury, Platinum, Premium Luxury	<b>US8148</b>
<b>CTS</b>			
2.0L L4 1998cc 122 CID	2014-2015	Base, Luxury, Performance, Premium; Pump only	<b>US8102</b>
2.0L L4 1998cc 122 CID	2015-2016	Base, Luxury, Performance, Premium	<b>US8102</b>
2.0L L4 1998cc 122 CID	2017	Base, Luxury	<b>US8102</b>
2.8L V6 2792cc 170 CID	2005-2007	Base	<b>US8932</b>
3.0L V6 182 CID	2010-2011	Base, Luxury, Performance	<b>US8932</b>
3.0L V6 182 CID	2012-2013	Base, Luxury	<b>US8932</b>
3.0L V6 2994cc 183 CID	2013	Mexican Application	<b>US8932</b>
3.2L V6 197 CID	2003	Base, Luxury, Luxury Sport	<b>US5079</b>
3.2L V6 197 CID	2004	Base	<b>US5079</b>
3.6L V6 222 CID	2016	Luxury, Performance, Premium	<b>US8148</b>
3.6L V6 222 CID	2017	Luxury, Premium Luxury	<b>US8148</b>
3.6L V6 3564cc 217 CID	2004-2009	Base	<b>US8932</b>
3.6L V6 3564cc 217 CID	2010	Luxury, Performance, Premium	<b>US8932</b>
3.6L V6 3564cc 217 CID	2011-2013	Base, Performance, Premium	<b>US8932</b>
3.6L V6 3564cc 217 CID	2015	Luxury, Performance, Premium, Vsport, Vsport Premium	<b>US8932</b>
3.6L V6 3564cc 217 CID	2016	Vsport, Vsport Premium	<b>US8932</b>
3.6L V6 3564cc 217 CID	2017	Vsport, Vsport Premium Luxury	<b>US8932</b>
5.7L V8 346 CID	2004-2005	V	<b>US65N</b>
5.7L V8 346 CID	2004-2005	V; Includes thermostat and thermostat housing	<b>US65N-T</b>
6.0L V8 5967cc 364 CID	2006-2007	V	<b>US65N</b>
6.0L V8 5967cc 364 CID	2006-2007	V; Includes thermostat and thermostat housing	<b>US65N-T</b>
6.2L V8 6162cc 376 CID	2009-2015	V	<b>US79</b>
6.2L V8 6162cc 376 CID	2016-2017	V	<b>US8918</b>
6.2L V8 6162cc 376 CID	2016-2017	V; Pump only	<b>US8918</b>
<b>CTS-V</b>			
6.2L V8 6200cc 378 CID	2013	Mexican Application	<b>US8932</b>
<b>DEVILLE</b>			
4.1L V6 252 CID	1980-1982	Base, Cabriolet, d'Elegance	<b>US1018</b>
4.1L V6 252 CID	1980-1982	Base, Cabriolet, d'Elegance; High performance	<b>US1018H</b>
4.1L V8 250 CID	1982-1984	Base, Cabriolet, d'Elegance	<b>US5010</b>
4.1L V8 250 CID	1985	Base, Cabriolet, d'Elegance	<b>US5023</b>
4.1L V8 250 CID	1986	d'Elegance, Touring	<b>US5023</b>
4.1L V8 250 CID	1987	Base, d'Elegance, Touring	<b>US5023</b>
4.3L V6 260 CID	1985	Base, Cabriolet, d'Elegance; W/O Pulley	<b>US5014</b>
4.3L V6 260 CID	1985	Base, Cabriolet, d'Elegance; Includes pulley	<b>US5014P</b>

Engine	Years	Application Description	USMW
<b>CADILLAC (cont'd.)</b>			
<b>DEVILLE (cont'd.)</b>			
4.5L V8 273 CID	1988-1990	Base	<b>US5023</b>
4.6L V8 281 CID	1994	Concours	<b>US5064</b>
4.6L V8 281 CID	1995	Concours	<b>US5072</b>
4.6L V8 281 CID	1996-1999	Base, Concours, d'Elegance	<b>US5072</b>
4.6L V8 281 CID	2000-2003	Base, DHS, DTS	<b>US5072</b>
4.6L V8 281 CID	2004-2005	Base, DHS, DTS, Protection Series	<b>US5072</b>
4.6L V8 4573cc 279 CID	1993	Mexican Application	<b>US5072</b>
4.9L V8 300 CID	1991	Base, Spring Edition, Touring	<b>US5023</b>
4.9L V8 300 CID	1992-1993	Base, Touring	<b>US5023</b>
4.9L V8 300 CID	1994-1995	Base	<b>US5023</b>
4.9L V8 4900cc 300 CID	1996-1997	Mexican Application	<b>US5072</b>
5.7L V8 350 CID	1980-1984	Base, Cabriolet, d'Elegance	<b>US1120</b>
5.7L V8 350 CID	1980-1984	Base, Cabriolet, d'Elegance; High performance	<b>US1120H</b>
6.0L V8 368 CID	1980-1981	Base, Cabriolet, d'Elegance	<b>US5003</b>
7.0L V8 425 CID	1977-1979		<b>US5003</b>
7.7L V8 472 CID	1968-1973		<b>US5003</b>
7.7L V8 7735cc 472 CID	1968-1973		<b>US5003</b>
<b>DTS</b>			
4.6L V8 281 CID	2006	Base	<b>US8956</b>
4.6L V8 281 CID	2007	Base, L	<b>US8956</b>
4.6L V8 281 CID	2008-2011	Base, L, Platinum	<b>US8956</b>
<b>ELDORADO</b>			
4.1L V6 252 CID	1981	Base, Biarritz, Brougham d'Elegance, Cabriolet	<b>US1018</b>
4.1L V6 252 CID	1981	Base, Biarritz, Brougham d'Elegance, Cabriolet; High performance	<b>US1018H</b>
4.1L V6 252 CID	1982	Base, Biarritz, Cabriolet, Touring	<b>US1018</b>
4.1L V6 252 CID	1982	Base, Biarritz, Cabriolet, Touring; High performance	<b>US1018H</b>
4.1L V8 250 CID	1982-1985	Base, Biarritz, Cabriolet, Touring	<b>US5010</b>
4.1L V8 250 CID	1986-1987	Base, Biarritz	<b>US5023</b>
4.5L V8 273 CID	1988-1989	Base, Biarritz	<b>US5023</b>
4.5L V8 273 CID	1990	Base, Biarritz, Touring	<b>US5023</b>
4.6L V8 281 CID	1993	Sport, Touring	<b>US5064</b>
4.6L V8 281 CID	1994	Base, Touring	<b>US5064</b>
4.6L V8 281 CID	1995-1997	Base, ETC	<b>US5072</b>
4.6L V8 281 CID	1998-2002	ESC, ETC	<b>US5072</b>
4.9L V8 300 CID	1991	Base, Biarritz, Spring Edition, Touring	<b>US5023</b>
4.9L V8 300 CID	1992	Base, Touring	<b>US5023</b>
4.9L V8 300 CID	1993	Base	<b>US5023</b>
5.7L V8 350 CID	1980	Base, Biarritz, Cabriolet	<b>US1120</b>
5.7L V8 350 CID	1980	Base, Biarritz, Cabriolet; High performance	<b>US1120H</b>
5.7L V8 350 CID	1981	Base, Biarritz, Brougham d'Elegance, Cabriolet	<b>US1120</b>
5.7L V8 350 CID	1981	Base, Biarritz, Brougham d'Elegance, Cabriolet; High performance	<b>US1120H</b>
5.7L V8 350 CID	1982-1983	Base, Biarritz, Cabriolet, Touring	<b>US1120</b>
5.7L V8 350 CID	1982-1983	Base, Biarritz, Cabriolet, Touring; High performance	<b>US1120H</b>
5.7L V8 350 CID	1984-1985	Base, Cabriolet, Touring	<b>US1120</b>
5.7L V8 350 CID	1984-1985	Base, Cabriolet, Touring; High performance	<b>US1120H</b>
6.0L V8 368 CID	1980	Base, Biarritz, Cabriolet	<b>US5003</b>
6.0L V8 368 CID	1981	Base, Biarritz, Brougham d'Elegance, Cabriolet	<b>US5003</b>
7.0L V8 425 CID	1977-1978		<b>US5003</b>
7.7L V8 472 CID	1968-1969		<b>US5003</b>
7.7L V8 7735cc 472 CID	1968-1969		<b>US5003</b>
8.2L V8 500 CID	1970-1973		<b>US5003</b>
8.2L V8 8193cc 500 CID	1970-1973		<b>US5003</b>
8.2L V8 8195cc 500 CID	1972-1973		<b>US5003</b>
<b>ELR</b>			
1.4L L4 1398cc 85 CID	2014-2015	Base	<b>US8152</b>
<b>ESCALADE</b>			
5.3L V8 5328cc 325 CID	2002-2005	Base	<b>US64</b>
5.3L V8 5328cc 325 CID	2002-2005	Base; Includes thermostat and thermostat housing	<b>US64-T</b>
5.7L V8 350 CID	1999-2000	Base	<b>US5077</b>
5.7L V8 350 CID	1999-2000	Base; High performance	<b>US5077H</b>
6.0L V8 5967cc 364 CID	2002-2006	Base	<b>US64</b>
6.0L V8 5967cc 364 CID	2002-2006	Base; Includes thermostat and thermostat housing	<b>US64-T</b>
6.0L V8 5967cc 364 CID	2009	Hybrid	<b>US6009</b>
6.0L V8 5967cc 364 CID	2009	Hybrid; Includes thermostat and thermostat housing	<b>US6009-T</b>
6.0L V8 5967cc 364 CID	2010-2013	Hybrid, Hybrid Platinum	<b>US6009</b>
6.0L V8 5967cc 364 CID	2010-2013	Hybrid, Hybrid Platinum; Includes thermostat and thermostat housing	<b>US6009-T</b>
6.2L V8 6162cc 376 CID	2007	Base	<b>US6009</b>
6.2L V8 6162cc 376 CID	2007	Base; Includes thermostat and thermostat housing	<b>US6009-T</b>
6.2L V8 6162cc 376 CID	2008-2010	Base, Platinum	<b>US6009</b>
6.2L V8 6162cc 376 CID	2008-2010	Base, Platinum; Includes thermostat and thermostat housing	<b>US6009-T</b>
6.2L V8 6162cc 376 CID	2011-2014	Base, Luxury, Platinum, Premium	<b>US6009</b>

Engine	Years	Application Description	USMW	Engine	Years	Application Description	USMW
<b>CADILLAC (cont'd.)</b>				<b>CADILLAC (cont'd.)</b>			
<b>ESCALADE (cont'd.)</b>				<b>STS</b>			
6.2L V8 6162cc 376 CID	2011-2014	Base, Luxury, Platinum, Premium; Includes thermostat and thermostat housing	US6009-T	3.6L V6 3564cc 217 CID	2005-2007	Base	US8932
6.2L V8 6162cc 376 CID	2015-2016	Base, Luxury, Platinum, Premium	US8918	3.6L V6 3564cc 217 CID	2008-2009	Base, Platinum	US8932
6.2L V8 6162cc 376 CID	2017	Base, Luxury, Platinum, Premium	US8918	3.6L V6 3564cc 217 CID	2010-2011	Base	US8932
<b>ESCALADE ESV</b>				4.4L V8 4371cc 267 CID 2006-2009 V US8955			
6.0L V8 5967cc 364 CID	2003-2006	Base	US64	4.6L V8 281 CID	2005-2007	Base	US8955
6.0L V8 5967cc 364 CID	2003-2006	Base; Includes thermostat and thermostat housing	US64-T	4.6L V8 281 CID	2008-2009	Base, Platinum	US8955
6.2L V8 6162cc 376 CID	2007	Base	US6009	4.6L V8 281 CID	2010	Base	US8955
6.2L V8 6162cc 376 CID	2007	Base; Includes thermostat and thermostat housing	US6009-T	<b>XLR</b>			
6.2L V8 6162cc 376 CID	2008-2010	Base, Platinum	US6009	4.4L V8 4371cc 267 CID	2006-2009	V	US8955
6.2L V8 6162cc 376 CID	2008-2010	Base, Platinum; Includes thermostat and thermostat housing	US6009-T	4.6L V8 281 CID	2004-2007	Base	US8955
6.2L V8 6162cc 376 CID	2011-2014	Base, Luxury, Platinum, Premium	US6009	4.6L V8 281 CID	2008	Base, Platinum	US8955
6.2L V8 6162cc 376 CID	2011-2014	Base, Luxury, Platinum, Premium; Includes thermostat and thermostat housing	US6009-T	4.6L V8 281 CID	2009	Platinum	US8955
6.2L V8 6162cc 376 CID	2015-2016	Base, Luxury, Platinum, Premium	US8918	<b>XT5</b>			
6.2L V8 6162cc 376 CID	2017	Base, Luxury, Platinum, Premium	US8918	3.6L V6 222 CID	2017	Base, Luxury, Platinum, Premium	US8148
<b>ESCALADE EXT</b>				<b>XTS</b>			
6.0L V8 5967cc 364 CID	2002-2006	Base	US64	3.6L V6 3564cc 217 CID	2013	Base, Livery, Luxury, Platinum, Premium	US8932
6.0L V8 5967cc 364 CID	2002-2006	Base; Includes thermostat and thermostat housing	US64-T	3.6L V6 3564cc 217 CID	2015-2016	Base, Livery, Luxury, Platinum, Premium, Vsport Platinum, Vsport Premium	US8932
6.2L V8 6162cc 376 CID	2007-2010	Base	US6009	3.6L V6 3564cc 217 CID	2017	Base, Livery, Luxury, Platinum, Premium Luxury, Vsport Premium Luxury	US8932
6.2L V8 6162cc 376 CID	2007-2010	Base; Includes thermostat and thermostat housing	US6009-T	<b>CHEVROLET</b>			
6.2L V8 6162cc 376 CID	2011-2013	Base, Luxury, Premium	US6009	<b>DELUXE</b>			
6.2L V8 6162cc 376 CID	2011-2013	Base, Luxury, Premium; Includes thermostat and thermostat housing	US6009-T	5.3L V8 5358cc 327 CID	1969		US898
<b>FLEETWOOD</b>				5.3L V8 5358cc 327 CID	1969	High performance	US898H
4.1L V6 252 CID	1980-1982	Brougham, Brougham d'Elegance	US1018	<b>MARATHON</b>			
4.1L V6 252 CID	1980-1982	Brougham, Brougham d'Elegance; High performance	US1018H	4.6L V8 4638cc 283 CID	1965-1967		US898
4.1L V8 250 CID	1982-1985	Brougham, Brougham d'Elegance	US5010	4.6L V8 4638cc 283 CID	1965-1967	High performance	US898H
4.1L V8 250 CID	1985	75, 75 Formal, Base, d'Elegance	US5023	5.0L V8 307 CID	1968		US898
4.1L V8 250 CID	1986	75, 75 Formal, Base	US5023	5.0L V8 307 CID	1968	High performance	US898H
4.1L V8 250 CID	1987	60 Special, 75, 75 Formal, Base, d'Elegance	US5023	5.0L V8 5031cc 307 CID	1968		US898
4.3L V6 260 CID	1985	75, 75 Formal, Base, d'Elegance; W/O Pulley	US5014	5.0L V8 5031cc 307 CID	1968	High performance	US898H
4.3L V6 260 CID	1985	75, 75 Formal, Base, d'Elegance; Includes pulley	US5014P	5.3L V8 5358cc 327 CID	1965-1969		US898
4.5L V8 273 CID	1988-1990	60 Special, Base, d'Elegance	US5023	5.3L V8 5358cc 327 CID	1965-1969	High performance	US898H
4.9L V8 300 CID	1991-1992	60 Special, Base, d'Elegance	US5023	<b>CHEVROLET</b>			
5.0L V8 307 CID	1986	Brougham, Brougham d'Elegance	US1120	<b>ASTRA</b>			
5.0L V8 307 CID	1986	Brougham, Brougham d'Elegance; High performance	US1120H	1.8L L4 1796cc 110 CID	2000-2003		US8933
5.7L V8 350 CID	1980-1985	Brougham, Brougham d'Elegance	US1120	1.8L L4 1796cc 110 CID	2007-2008		US8933
5.7L V8 350 CID	1980-1985	Brougham, Brougham d'Elegance; High performance	US1120H	1.8L L4 1796cc 110 CID	2007-2008	Mexican Application	US8933
5.7L V8 350 CID	1993	Base, Brougham	US5049	<b>ASTRO</b>			
5.7L V8 350 CID	1993	Base, Brougham; High performance	US5049H	2.5L L4 2474cc 151 CID	1985	Base, CL, CS	US5022
5.7L V8 350 CID	1994-1996	Base, Brougham	US5069	2.5L L4 2474cc 151 CID	1986	Base	US5022
6.0L V8 368 CID	1980-1981	Base, Brougham, Brougham d'Elegance, Formal	US5003	2.5L L4 2474cc 151 CID	1987-1990	Base	US5040
6.0L V8 368 CID	1982-1984	Base, Formal	US5003	4.3L V6 262 CID	1985-1986	Base, CL, CS	US1121
7.0L V8 425 CID	1977-1979		US5003	4.3L V6 262 CID	1985-1986	Base, CL, CS; High performance	US1121H
7.7L V8 472 CID	1968-1973		US5003	4.3L V6 262 CID	1987-1995	Base, CL, CS, LT	US5049
7.7L V8 7735cc 472 CID	1968-1973		US5003	4.3L V6 262 CID	1987-1995	Base, CL, CS, LT; High performance	US5049H
<b>SEVILLE</b>				4.3L V6 262 CID	1996-2005	Base, LS, LT	US5077
4.1L V6 252 CID	1981-1982	Base, Elegante	US1018	4.3L V6 262 CID	1996-2005	Base, LS, LT; High performance	US5077H
4.1L V6 252 CID	1981-1982	Base, Elegante; High performance	US1018H	<b>AVALANCHE</b>			
4.1L V8 250 CID	1982-1985	Base, Elegante	US5010	5.3L V8 5328cc 325 CID	2007-2012	LS, LT, LTZ	US6009
4.1L V8 250 CID	1986	Base, Elegante	US5023	5.3L V8 5328cc 325 CID	2007-2012	LS, LT, LTZ; Includes thermostat and thermostat housing	US6009-T
4.1L V8 250 CID	1987	Base	US5023	5.3L V8 5328cc 325 CID	2010-2012	Mexican Application	US6009
4.5L V8 273 CID	1988-1990	Base, STS	US5023	5.3L V8 5328cc 325 CID	2013	Black Diamond LS, Black Diamond LT, Black Diamond LTZ	US6009
4.6L V8 281 CID	1993	STS	US5064	5.3L V8 5328cc 325 CID	2013	Black Diamond LS, Black Diamond LT, Black Diamond LTZ; Includes thermostat and thermostat housing	US6009-T
4.6L V8 281 CID	1994	SLS, STS	US5064	5.3L V8 5328cc 325 CID	2013	Black Diamond LS, Black Diamond LT, Black Diamond LTZ; Includes thermostat and thermostat housing	US6009-T
4.6L V8 281 CID	1995-2003	SLS, STS	US5072	5.3L V8 5328cc 325 CID	2013	Black Diamond LTZ; (0), (LMG); Includes thermostat and thermostat housing	US6009-T
4.6L V8 281 CID	2004	SLS	US5072	6.0L V8 5967cc 364 CID	2007-2009	LT, LTZ	US6009
4.9L V8 300 CID	1991-1992	Base, STS	US5023	6.0L V8 5967cc 364 CID	2007-2009	LT, LTZ; Includes thermostat and thermostat housing	US6009-T
4.9L V8 300 CID	1993	Base	US5023	<b>AVALANCHE 1500</b>			
5.7L V8 350 CID	1980-1985	Base, Elegante	US1120	5.3L V8 5328cc 325 CID	2002	Base, On Road Edition, Z71	US64
5.7L V8 350 CID	1980-1985	Base, Elegante; High performance	US1120H	5.3L V8 5328cc 325 CID	2002	Base, On Road Edition, Z71; Includes thermostat and thermostat housing	US64-T
6.0L V8 368 CID	1980-1981	Base, Elegante	US5003	5.3L V8 5328cc 325 CID	2003	Base, North Face, On Road Edition, WBH, Z71	US64
<b>SRX</b>				5.3L V8 5328cc 325 CID	2003	Base, North Face, On Road Edition, WBH, Z71; Includes thermostat and thermostat housing	US64-T
2.8L V6 2792cc 170 CID	2010-2011	Performance, Premium	US8932	5.3L V8 5328cc 325 CID	2004	Base, Z66, Z71	US64
3.0L V6 182 CID	2010-2011	Base, Luxury, Performance, Premium	US8932	5.3L V8 5328cc 325 CID	2004	Base, Z66, Z71; Includes thermostat and thermostat housing	US64-T
3.6L V6 3564cc 217 CID	2004-2009	Base	US8932	5.3L V8 5328cc 325 CID	2005	Base, LS, LT, Z66, Z71	US64
3.6L V6 3564cc 217 CID	2012-2013	Base, Luxury, Performance, Premium	US8932	5.3L V8 5328cc 325 CID	2005	Base, LS, LT, Z66, Z71; Includes thermostat and thermostat housing	US64-T
3.6L V6 3564cc 217 CID	2015-2016	Base, Luxury, Performance, Premium	US8932	5.3L V8 5328cc 325 CID	2006	LS, LT, Z66, Z71	US64
4.6L V8 281 CID	2004-2009	Base	US8955				

WATER PUMPS



Engine	Years	Application Description	USMW	Engine	Years	Application Description	USMW
<b>CHEVROLET (cont'd.)</b>				<b>CHEVROLET (cont'd.)</b>			
<b>AVALANCHE 1500 (cont'd.)</b>				<b>BISCAYNE</b>			
5.3L V8 5328cc 325 CID	2006	LS, LT, Z66, Z71; Includes thermostat and thermostat housing	<b>US64-T</b>	4.6L V8 283 CID	1960		<b>US898</b>
<b>AVALANCHE 2500</b>				4.6L V8 283 CID	1960	High performance	<b>US898H</b>
8.1L V8 496 CID	2002-2004	Base	<b>US5089</b>	4.6L V8 4638cc 283 CID	1958-1967		<b>US898</b>
8.1L V8 496 CID	2002-2004	Base; High performance	<b>US5089H</b>	4.6L V8 4638cc 283 CID	1958-1967	High performance	<b>US898H</b>
8.1L V8 496 CID	2005-2006	LS, LT	<b>US5089</b>	5.0L V8 307 CID	1968		<b>US898</b>
8.1L V8 496 CID	2005-2006	LS, LT; High performance	<b>US5089H</b>	5.0L V8 307 CID	1968	High performance	<b>US898H</b>
<b>AVEO</b>				5.0L V8 5031cc 307 CID	1968		<b>US898</b>
1.6L L4 1598cc 97 CID	2010-2012	Mexican Application	<b>US6184</b>	5.0L V8 5031cc 307 CID	1968	High performance	<b>US898H</b>
1.6L L4 1598cc 97 CID	2010-2016	Mexican Application	<b>US6046</b>	5.3L V8 5358cc 327 CID	1962-1969		<b>US898</b>
1.6L L4 1598cc 98 CID	2004	Base, LS	<b>US6046</b>	5.3L V8 5358cc 327 CID	1962-1969	High performance	<b>US898H</b>
1.6L L4 1598cc 98 CID	2005-2006	LS, LT, Special Value	<b>US6046</b>	5.4L V8 327 CID	1968-1969		<b>US898</b>
1.6L L4 1598cc 98 CID	2007-2008	LS, LT	<b>US6046</b>	5.4L V8 327 CID	1968-1969	High performance	<b>US898H</b>
1.6L L4 1598cc 98 CID	2009-2011	LS, LT	<b>US6184</b>	5.7L V8 348 CID	1960		<b>US898</b>
<b>AVEO5</b>				5.7L V8 348 CID	1960	High performance	<b>US898H</b>
1.6L L4 1598cc 98 CID	2007-2008	LS, Special Value	<b>US6046</b>	5.7L V8 350 CID	1969-1972		<b>US898</b>
1.6L L4 1598cc 98 CID	2009-2011	LS, LT	<b>US6184</b>	5.7L V8 350 CID	1969-1972	High performance	<b>US898H</b>
<b>B7</b>				5.7L V8 5704cc 348 CID	1958-1961		<b>US127</b>
6.0L V8 366 CID	1993-1998	With threaded hub for fan clutch	<b>US5078</b>	5.7L V8 5704cc 348 CID	1958-1961		<b>US898</b>
7.0L V8 6998cc 427 CID	1994-1998	With threaded hub for fan clutch	<b>US5078</b>	5.7L V8 5704cc 348 CID	1958-1961	High performance	<b>US898H</b>
<b>B60</b>				5.7L V8 5736cc 350 CID	1969-1972		<b>US898</b>
6.0L V8 366 CID	1980-1990	Without threaded hub	<b>US5084</b>	5.7L V8 5736cc 350 CID	1969-1972	High performance	<b>US898H</b>
6.0L V8 366 CID	1990-1991	With threaded hub for fan clutch	<b>US5078</b>	6.5L V8 396 CID	1968-1969		<b>US981</b>
7.0L V8 427 CID	1980-1985	Without threaded hub	<b>US5084</b>	6.5L V8 396 CID	1968-1969		<b>US981</b>
<b>BEL AIR</b>				6.5L V8 6489cc 396 CID	1966-1969		<b>US981</b>
4.3L L6 4278cc 261 CID	1959-1960		<b>US898</b>	6.6L V8 400 CID	1970-1972		<b>US981</b>
4.3L L6 4278cc 261 CID	1959-1960	High performance	<b>US898H</b>	6.6L V8 402 CID	1971-1972		<b>US981</b>
4.3L V8 265 CID	1955-1957		<b>US898</b>	6.6L V8 6555cc 400 CID	1970-1972		<b>US981</b>
4.3L V8 265 CID	1955-1957	High performance	<b>US898H</b>	6.6L V8 6556cc 400 CID	1970-1972		<b>US981</b>
4.3L V8 4343cc 265 CID	1955-1957		<b>US898</b>	6.6L V8 6588cc 402 CID	1970-1972		<b>US981</b>
4.3L V8 4343cc 265 CID	1955-1957	High performance	<b>US898H</b>	6.7L V8 6704cc 409 CID	1961-1963		<b>US127</b>
4.6L V8 283 CID	1957		<b>US898</b>	6.7L V8 6704cc 409 CID	1964	1 3/4" mount holes 4 1/2" hub height	<b>US127</b>
4.6L V8 283 CID	1957	High performance	<b>US898H</b>	7.0L V8 427 CID	1968-1969		<b>US981</b>
4.6L V8 4638cc 283 CID	1957-1967		<b>US898</b>	7.0L V8 6998cc 427 CID	1966-1969		<b>US981</b>
4.6L V8 4638cc 283 CID	1957-1967	High performance	<b>US898H</b>	<b>BLAZER</b>			
5.0L V8 307 CID	1968		<b>US898</b>	4.3L V6 262 CID	1995	Base, LT	<b>US5049</b>
5.0L V8 307 CID	1968	High performance	<b>US898H</b>	4.3L V6 262 CID	1995	Base, LT; High performance	<b>US5049H</b>
5.0L V8 5031cc 307 CID	1968		<b>US898</b>	4.3L V6 262 CID	1996-1998	Base, LS, LT	<b>US5077</b>
5.0L V8 5031cc 307 CID	1968	High performance	<b>US898H</b>	4.3L V6 262 CID	1996-1998	Base, LS, LT; High performance	<b>US5077H</b>
5.3L V8 5272cc 322 CID	1959		<b>US898</b>	4.3L V6 262 CID	1999	Base, LS, LT, Trailblazer	<b>US5077</b>
5.3L V8 5272cc 322 CID	1959	High performance	<b>US898H</b>	4.3L V6 262 CID	1999	Base, LS, LT, Trailblazer; High performance	<b>US5077H</b>
5.3L V8 5358cc 327 CID	1962-1969		<b>US898</b>	4.3L V6 262 CID	2000	LS, LT, Trailblazer	<b>US5077</b>
5.3L V8 5358cc 327 CID	1962-1969	High performance	<b>US898H</b>	4.3L V6 262 CID	2000	LS, LT, Trailblazer; High performance	<b>US5077H</b>
5.4L V8 327 CID	1968-1969		<b>US898</b>	4.3L V6 262 CID	2001	LS, LT, Trailblazer, Xtreme	<b>US5077</b>
5.4L V8 327 CID	1968-1969	High performance	<b>US898H</b>	4.3L V6 262 CID	2001	LS, LT, Trailblazer, Xtreme; High performance	<b>US5077H</b>
5.7L V8 350 CID	1969-1972		<b>US898</b>	4.3L V6 262 CID	2002	LS, Xtreme	<b>US5077</b>
5.7L V8 350 CID	1969-1972	High performance	<b>US898H</b>	4.3L V6 262 CID	2002	LS, Xtreme; High performance	<b>US5077H</b>
5.7L V8 5704cc 348 CID	1958-1961		<b>US127</b>	4.3L V6 262 CID	2003-2004	LS, Xtreme, ZR2	<b>US5077</b>
5.7L V8 5704cc 348 CID	1958-1961	High performance	<b>US898</b>	4.3L V6 262 CID	2003-2004	LS, Xtreme, ZR2; High performance	<b>US5077H</b>
5.7L V8 5704cc 348 CID	1958-1961		<b>US898H</b>	4.3L V6 262 CID	2005	Base, Xtreme, ZR2	<b>US5077</b>
5.7L V8 5736cc 350 CID	1969-1972		<b>US898</b>	4.3L V6 262 CID	2005	Base, Xtreme, ZR2; High performance	<b>US5077H</b>
5.7L V8 5736cc 350 CID	1969-1972	High performance	<b>US898H</b>	4.8L L6 292 CID	1970		<b>US896</b>
6.5L V8 396 CID	1968-1969		<b>US981</b>	4.8L L6 292 CID	1973		<b>US896</b>
6.5L V8 396 CID	1968-1969		<b>US981</b>	4.8L L6 4786cc 292 CID	1973		<b>US896</b>
6.6L V8 400 CID	1970-1972		<b>US981</b>	4.8L L6 4801cc 292 CID	1969-1974		<b>US896</b>
6.6L V8 400 CID	1975		<b>US1109</b>	5.0L V8 305 CID	1987	Custom Deluxe, Silverado	<b>US1121</b>
6.6L V8 400 CID	1975	High performance	<b>US1109H</b>	5.0L V8 305 CID	1987	Custom Deluxe, Silverado; High performance	<b>US1121H</b>
6.6L V8 402 CID	1971-1972		<b>US981</b>	5.0L V8 307 CID	1969-1972		<b>US898</b>
6.6L V8 6555cc 400 CID	1970-1972		<b>US981</b>	5.0L V8 307 CID	1969-1972	High performance	<b>US898H</b>
6.6L V8 6556cc 400 CID	1970-1972		<b>US981</b>	5.0L V8 5031cc 307 CID	1969-1972		<b>US898</b>
6.6L V8 6588cc 402 CID	1970-1972		<b>US981</b>	5.0L V8 5031cc 307 CID	1969-1972	High performance	<b>US898H</b>
6.7L V8 6704cc 409 CID	1961-1963		<b>US127</b>	5.7L V8 350 CID	1969-1972		<b>US898</b>
6.7L V8 6704cc 409 CID	1964	1 3/4" mount holes 4 1/2" hub height	<b>US127</b>	5.7L V8 350 CID	1969-1972	High performance	<b>US898H</b>
7.0L V8 427 CID	1968-1969		<b>US981</b>	5.7L V8 350 CID	1987	High performance	<b>US898H</b>
7.0L V8 6998cc 427 CID	1966-1969		<b>US981</b>	5.7L V8 350 CID	1987	Custom Deluxe, Silverado	<b>US1121</b>
7.4L V8 454 CID	1975	Base	<b>US1002</b>	5.7L V8 350 CID	1987	Custom Deluxe, Silverado; High performance	<b>US1121H</b>
7.4L V8 454 CID	1975	Base; High performance	<b>US1002H</b>	5.7L V8 350 CID	1988	Scottsdale, Silverado	<b>US1121</b>
<b>BERETTA</b>				5.7L V8 350 CID	1988	Scottsdale, Silverado; High performance	<b>US1121H</b>
2.0L L4 122 CID	1987-1989	Base	<b>US5032</b>	5.7L V8 350 CID	1989-1991	Scottsdale, Silverado	<b>US5049</b>
2.2L L4 134 CID	1990	Base, Indianapolis 500 Pace Car	<b>US5032</b>	5.7L V8 350 CID	1989-1991	Scottsdale, Silverado; High performance	<b>US5049H</b>
2.2L L4 134 CID	1991	Base	<b>US5032</b>	5.7L V8 350 CID	1992-1993	Cheyenne, Silverado	<b>US5049</b>
2.2L L4 2190cc 134 CID	1992-1993	Base, GT	<b>US5032</b>	5.7L V8 350 CID	1992-1993	Cheyenne, Silverado; High performance	<b>US5049H</b>
2.2L L4 2190cc 134 CID	1994-1996	Base	<b>US5032</b>	5.7L V8 350 CID	1994	Base, Silverado, Silverado Sport	<b>US5049</b>
2.3L L4 140 CID	1990	GTZ, Indianapolis 500 Pace Car	<b>US5043</b>	5.7L V8 350 CID	1994	Base, Silverado, Silverado Sport; High performance	<b>US5049H</b>
2.3L L4 140 CID	1991-1993	GTZ	<b>US5043</b>	5.7L V8 350 CID	1994		<b>US5049</b>
2.3L L4 140 CID	1994	Z26	<b>US5043</b>	5.7L V8 5736cc 350 CID	1969-1972		<b>US898</b>
2.8L V6 173 CID	1987-1988	Base	<b>US5033</b>	5.7L V8 5736cc 350 CID	1969-1972	High performance	<b>US898H</b>
2.8L V6 173 CID	1989	Base, GT	<b>US5033</b>	6.2L V8 379 CID	1987	Custom Deluxe, Silverado	<b>US5008</b>
3.1L V6 189 CID	1990	Base, GT, Indianapolis 500 Pace Car	<b>US5033</b>	6.2L V8 379 CID	1988-1991	Scottsdale, Silverado	<b>US5008</b>
3.1L V6 189 CID	1991-1993	Base, GT, GTZ	<b>US5033</b>	6.5L V8 395 CID	1994	Base, Silverado, Silverado Sport	<b>US5062</b>
3.1L V6 189 CID	1994-1996	Base, Z26	<b>US5033</b>	<b>BOSS TRUCK</b>			
				5.7L V8 5700cc 350 CID	1996-1997	Mexican Application	<b>US5077</b>

Engine	Years	Application Description	USMW	Engine	Years	Application Description	USMW
<b>CHEVROLET (cont'd.)</b>				<b>CHEVROLET (cont'd.)</b>			
<b>BROOKWOOD</b>				<b>C10 (cont'd.)</b>			
4.6L V8 283 CID	1958		US898	7.4L V8 454 CID	1980	Big Ten, Cheyenne, Custom Deluxe, Scottsdale, Silverado	US1002
4.6L V8 283 CID	1958	High performance	US898H	7.4L V8 454 CID	1980	Big Ten, Cheyenne, Custom Deluxe, Scottsdale, Silverado; High performance	US1002H
4.6L V8 4638cc 283 CID	1959-1961		US898	<b>C10 PICKUP</b>			
4.6L V8 4638cc 283 CID	1959-1961	High performance	US898H	4.3L L6 4278cc 261 CID	1961-1962		US898
5.0L V8 5031cc 307 CID	1969		US898	4.3L L6 4278cc 261 CID	1961-1962	High performance	US898H
5.0L V8 5031cc 307 CID	1969	High performance	US898H	4.6L V8 4638cc 283 CID	1960-1967		US898
5.0L V8 5031cc 307 CID	1971-1972		US898	4.6L V8 4638cc 283 CID	1960-1967	High performance	US898H
5.0L V8 5031cc 307 CID	1971-1972	High performance	US898H	4.8L L6 292 CID	1968-1971		US896
5.3L V8 5358cc 327 CID	1969		US898	4.8L L6 292 CID	1973-1974		US896
5.3L V8 5358cc 327 CID	1969	High performance	US898H	4.8L L6 4786cc 292 CID	1973-1974		US896
5.7L V8 348 CID	1958		US898	4.8L L6 4801cc 292 CID	1965-1974		US896
5.7L V8 348 CID	1958	High performance	US898H	5.0L V8 307 CID	1968-1972		US898
5.7L V8 350 CID	1969-1972		US898	5.0L V8 307 CID	1968-1972	High performance	US898H
5.7L V8 350 CID	1969-1972	High performance	US898H	5.0L V8 5031cc 307 CID	1968-1972		US898
5.7L V8 5704cc 348 CID	1959-1961		US898	5.0L V8 5031cc 307 CID	1968-1972	High performance	US898H
5.7L V8 5704cc 348 CID	1959-1961	High performance	US898H	5.3L V8 5358cc 327 CID	1966-1969		US898
5.7L V8 5736cc 350 CID	1969-1972		US898	5.3L V8 5358cc 327 CID	1966-1969	High performance	US898H
5.7L V8 5736cc 350 CID	1969-1972	High performance	US898H	5.4L V8 327 CID	1968		US898
<b>C10</b>				5.4L V8 327 CID	1968	High performance	US898H
4.1L L6 250 CID	1975-1977		US1110	5.7L V8 350 CID	1969-1972		US898
4.1L L6 250 CID	1978-1979		US1107	5.7L V8 350 CID	1969-1972	High performance	US898H
4.1L L6 250 CID	1980	Big Ten, Cheyenne, Custom Deluxe, Scottsdale, Silverado	US1107	5.7L V8 5704cc 348 CID	1960-1961		US898
4.1L L6 250 CID	1981	Custom, Deluxe	US1107	5.7L V8 5704cc 348 CID	1960-1961	High performance	US898H
4.1L L6 250 CID	1982	Custom, Scottsdale, Silverado	US1107	5.7L V8 5736cc 350 CID	1969-1972		US898
4.1L L6 250 CID	1983	Custom, Silverado	US1107	5.7L V8 5736cc 350 CID	1969-1972	High performance	US898H
4.1L L6 250 CID	1984	Custom, Scottsdale, Silverado	US1107	6.5L V8 396 CID	1968-1969		US981
4.1L L6 4097cc 250 CID	1979		US1107	6.5L V8 6489cc 396 CID	1968-1969		US981
4.1L L6 4100cc 250 CID	1979-1984	Mexican Application	US1107	6.6L V8 402 CID	1970-1972		US981
4.3L V6 262 CID	1985-1986	Custom, Scottsdale, Silverado	US1121	6.6L V8 6588cc 402 CID	1970-1972		US981
4.3L V6 262 CID	1985-1986	Custom, Scottsdale, Silverado; High performance	US1121H	<b>C10 SUBURBAN</b>			
4.8L L6 292 CID	1980	Big Ten, Cheyenne, Custom Deluxe, Scottsdale, Silverado	US5030	4.1L L6 250 CID	1975-1977		US1110
4.8L L6 4800cc 292 CID	1981-1982	Mexican Application	US5030	4.1L L6 250 CID	1978-1979		US1107
4.8L L6 4800cc 292 CID	1982-1986	Mexican Application	US896	4.1L L6 250 CID	1980	Custom Deluxe, Scottsdale, Silverado	US1107
4.8L L6 4800cc 292 CID	1984-1986	Mexican Application	US5030	4.6L V8 4638cc 283 CID	1967		US898
5.0L V8 305 CID	1977-1979		US1121	4.6L V8 4638cc 283 CID	1967	High performance	US898H
5.0L V8 305 CID	1977-1979	High performance	US1121H	4.8L L6 292 CID	1968-1971		US896
5.0L V8 305 CID	1980	Big Ten, Cheyenne, Custom Deluxe, Scottsdale, Silverado	US1121	4.8L L6 292 CID	1973-1974		US896
5.0L V8 305 CID	1980	Big Ten, Cheyenne, Custom Deluxe, Scottsdale, Silverado; High performance	US1121H	4.8L L6 4786cc 292 CID	1973-1974		US896
5.0L V8 305 CID	1981	Custom, Deluxe	US1121	4.8L L6 4801cc 292 CID	1967-1974		US896
5.0L V8 305 CID	1981	Custom, Deluxe; High performance	US1121H	5.0L V8 305 CID	1977-1979		US1121
5.0L V8 305 CID	1982	Custom, Scottsdale, Silverado	US1121	5.0L V8 305 CID	1977-1979	High performance	US1121H
5.0L V8 305 CID	1982	Custom, Scottsdale, Silverado; High performance	US1121H	5.0L V8 305 CID	1980	Custom Deluxe, Scottsdale, Silverado	US1121
5.0L V8 305 CID	1983	Custom, Silverado	US1121	5.0L V8 305 CID	1980	Custom Deluxe, Scottsdale, Silverado; High performance	US1121H
5.0L V8 305 CID	1983	Custom, Silverado; High performance	US1121H	5.0L V8 305 CID	1981	Custom, Deluxe	US1121
5.0L V8 305 CID	1984-1986	Custom, Scottsdale, Silverado	US1121	5.0L V8 305 CID	1981	Custom, Deluxe; High performance	US1121H
5.0L V8 305 CID	1984-1986	Custom, Scottsdale, Silverado; High performance	US1121H	5.0L V8 305 CID	1982	Custom, Scottsdale, Silverado	US1121
5.7L V8 350 CID	1975-1976		US1109	5.0L V8 305 CID	1982	Custom, Scottsdale, Silverado; High performance	US1121H
5.7L V8 350 CID	1975-1976	High performance	US1109H	5.0L V8 305 CID	1983	Custom, Silverado	US1121
5.7L V8 350 CID	1977-1979		US1121	5.0L V8 305 CID	1983	Custom, Silverado; High performance	US1121H
5.7L V8 350 CID	1977-1979	High performance	US1121H	5.0L V8 305 CID	1984-1986	Custom, Scottsdale, Silverado	US1121
5.7L V8 350 CID	1980	Big Ten, Cheyenne, Custom Deluxe, Scottsdale, Silverado	US1121	5.0L V8 305 CID	1984-1986	Custom, Scottsdale, Silverado; High performance	US1121H
5.7L V8 350 CID	1980	Big Ten, Cheyenne, Custom Deluxe, Scottsdale, Silverado; High performance	US1121H	5.0L V8 307 CID	1968-1972		US898
5.7L V8 350 CID	1981	Custom, Deluxe	US1121	5.0L V8 307 CID	1968-1972	High performance	US898H
5.7L V8 350 CID	1981	Custom, Deluxe; High performance	US1121H	5.0L V8 5031cc 307 CID	1968-1972		US898
5.7L V8 350 CID	1982	Custom, Scottsdale, Silverado	US1121	5.0L V8 5031cc 307 CID	1968-1972	High performance	US898H
5.7L V8 350 CID	1982	Custom, Scottsdale, Silverado; High performance	US1121H	5.3L V8 5358cc 327 CID	1967-1969		US898
5.7L V8 350 CID	1982	Custom, Silverado	US1121	5.3L V8 5358cc 327 CID	1967-1969	High performance	US898H
5.7L V8 350 CID	1983	Custom, Silverado	US1121	5.4L V8 327 CID	1968		US898
5.7L V8 350 CID	1983	Custom, Silverado; High performance	US1121H	5.4L V8 327 CID	1968	High performance	US898H
5.7L V8 350 CID	1984-1986	Custom, Scottsdale, Silverado	US1121	5.7L V8 350 CID	1969-1972		US898
5.7L V8 350 CID	1984-1986	Custom, Scottsdale, Silverado; High performance	US1121H	5.7L V8 350 CID	1969-1972	High performance	US898H
5.7L V8 350 CID	1984-1986	Custom, Scottsdale, Silverado	US1121	5.7L V8 350 CID	1975-1976		US1109
5.7L V8 350 CID	1984-1986	Custom, Scottsdale, Silverado; High performance	US1121H	5.7L V8 350 CID	1975-1976	High performance	US1109H
5.7L V8 5700cc 350 CID	1981-1985	Mexican Application	US1121	5.7L V8 350 CID	1977-1979		US1121
5.7L V8 5700cc 350 CID	1987	Mexican Application	US1121	5.7L V8 350 CID	1977-1979	High performance	US1121H
6.2L V8 379 CID	1982	Custom, Scottsdale, Silverado	US5008	5.7L V8 350 CID	1980	Custom Deluxe, Scottsdale, Silverado; High performance	US1121H
6.2L V8 379 CID	1983	Custom, Silverado	US5008	5.7L V8 350 CID	1981	Custom, Deluxe	US1121
6.2L V8 379 CID	1984-1986	Custom, Scottsdale, Silverado	US5008	5.7L V8 350 CID	1981	Custom, Deluxe; High performance	US1121H
6.6L V8 400 CID	1976		US1109	5.7L V8 350 CID	1982	Custom, Scottsdale, Silverado	US1121
6.6L V8 400 CID	1976	High performance	US1109H	5.7L V8 350 CID	1982	Custom, Scottsdale, Silverado; High performance	US1121H
6.6L V8 400 CID	1977-1979		US1121	5.7L V8 350 CID	1983	Custom, Silverado	US1121
6.6L V8 400 CID	1977-1979	High performance	US1121H	5.7L V8 350 CID	1983	Custom, Silverado; High performance	US1121H
6.6L V8 400 CID	1980	Big Ten, Cheyenne, Custom Deluxe, Scottsdale, Silverado	US1121	5.7L V8 350 CID	1984-1986	Custom, Scottsdale, Silverado	US1121
6.6L V8 400 CID	1980	Big Ten, Cheyenne, Custom Deluxe, Scottsdale, Silverado; High performance	US1121H	5.7L V8 350 CID	1984-1986	Custom, Scottsdale, Silverado; High performance	US1121H
7.4L V8 454 CID	1975-1979		US1002	5.7L V8 5736cc 350 CID	1969-1972		US898
7.4L V8 454 CID	1975-1979	High performance	US1002H	5.7L V8 5736cc 350 CID	1969-1972	High performance	US898H
				6.2L V8 379 CID	1982	Custom, Scottsdale, Silverado	US5008

WATER PUMPS

Engine	Years	Application Description	USMW	Engine	Years	Application Description	USMW
<b>CHEVROLET (cont'd.)</b>				<b>CHEVROLET (cont'd.)</b>			
<b>C10 SUBURBAN (cont'd.)</b>				<b>C20 (cont'd.)</b>			
6.2L V8 379 CID	1983	Custom, Silverado	<b>US5008</b>	7.4L V8 454 CID	1983	Custom, Silverado	<b>US1002</b>
6.2L V8 379 CID	1984-1986	Custom, Scottsdale, Silverado	<b>US5008</b>	7.4L V8 454 CID	1983	Custom, Silverado; High performance	<b>US1002H</b>
6.5L V8 396 CID	1968-1969		<b>US981</b>	7.4L V8 454 CID	1984-1986	Custom, Scottsdale, Silverado	<b>US1002</b>
6.5L V8 6489cc 396 CID	1968-1969		<b>US981</b>	7.4L V8 454 CID	1984-1986	Custom, Scottsdale, Silverado; High performance	<b>US1002H</b>
6.6L V8 402 CID	1970-1972		<b>US981</b>	<b>C20 PICKUP</b>			
6.6L V8 6588cc 402 CID	1970-1972		<b>US981</b>	4.3L L6 4278cc 261 CID	1961-1962		<b>US898</b>
7.4L V8 454 CID	1975-1979		<b>US1002</b>	4.3L L6 4278cc 261 CID	1961-1962	High performance	<b>US898H</b>
7.4L V8 454 CID	1975-1979	High performance	<b>US1002H</b>	4.6L V8 4638cc 283 CID	1960-1967		<b>US898</b>
7.4L V8 454 CID	1980	Custom Deluxe, Scottsdale, Silverado	<b>US1002</b>	4.6L V8 4638cc 283 CID	1960-1967	High performance	<b>US898H</b>
7.4L V8 454 CID	1980	Custom Deluxe, Scottsdale, Silverado; High performance	<b>US1002H</b>	5.0L V8 307 CID	1968-1972		<b>US898</b>
<b>C20</b>				5.0L V8 307 CID	1968-1972	High performance	<b>US898H</b>
4.1L L6 250 CID	1975-1979		<b>US1107</b>	5.0L V8 5031cc 307 CID	1968-1972		<b>US898</b>
4.1L L6 250 CID	1980	Cheyenne, Custom Deluxe, Scottsdale, Silverado	<b>US1107</b>	5.0L V8 5031cc 307 CID	1968-1972	High performance	<b>US898H</b>
4.1L L6 250 CID	1981	Custom, Deluxe	<b>US1107</b>	5.3L V8 5358cc 327 CID	1966-1969		<b>US898</b>
4.1L L6 250 CID	1982	Custom, Scottsdale, Silverado	<b>US1107</b>	5.3L V8 5358cc 327 CID	1966-1969	High performance	<b>US898H</b>
4.1L L6 250 CID	1983	Custom, Silverado	<b>US1107</b>	5.4L V8 327 CID	1968		<b>US898</b>
4.1L L6 250 CID	1984	Custom, Scottsdale, Silverado	<b>US1107</b>	5.4L V8 327 CID	1968	High performance	<b>US898H</b>
4.3L V6 262 CID	1985-1986	Custom, Scottsdale, Silverado	<b>US1121</b>	5.7L V8 350 CID	1969-1972		<b>US898</b>
4.3L V6 262 CID	1985-1986	Custom, Scottsdale, Silverado; High performance	<b>US1121H</b>	5.7L V8 350 CID	1969-1972	High performance	<b>US898H</b>
4.8L L6 292 CID	1975-1977		<b>US1137</b>	5.7L V8 5704cc 348 CID	1960-1961		<b>US898</b>
4.8L L6 292 CID	1975-1977	High performance	<b>US1137H</b>	5.7L V8 5704cc 348 CID	1960-1961	High performance	<b>US898H</b>
4.8L L6 292 CID	1978-1979		<b>US5030</b>	5.7L V8 5736cc 350 CID	1969-1972		<b>US898</b>
4.8L L6 292 CID	1980	Cheyenne, Custom Deluxe, Scottsdale, Silverado	<b>US5030</b>	5.7L V8 5736cc 350 CID	1969-1972	High performance	<b>US898H</b>
4.8L L6 292 CID	1981	Custom, Deluxe	<b>US5030</b>	6.5L V8 396 CID	1968-1969		<b>US981</b>
4.8L L6 292 CID	1982	Custom, Scottsdale, Silverado	<b>US5030</b>	6.5L V8 6489cc 396 CID	1968-1969		<b>US981</b>
4.8L L6 292 CID	1983	Custom, Silverado	<b>US5030</b>	6.6L V8 402 CID	1970-1972		<b>US981</b>
4.8L L6 292 CID	1984-1986	Custom, Scottsdale, Silverado	<b>US5030</b>	6.6L V8 6588cc 402 CID	1970-1972		<b>US981</b>
5.0L V8 305 CID	1977-1979		<b>US1121</b>	<b>C20 SUBURBAN</b>			
5.0L V8 305 CID	1977-1979	High performance	<b>US1121H</b>	4.6L V8 4638cc 283 CID	1967		<b>US898</b>
5.0L V8 305 CID	1980	Cheyenne, Custom Deluxe, Scottsdale, Silverado	<b>US1121</b>	4.6L V8 4638cc 283 CID	1967	High performance	<b>US898H</b>
5.0L V8 305 CID	1980	Cheyenne, Custom Deluxe, Scottsdale, Silverado; High performance	<b>US1121H</b>	4.8L L6 292 CID	1968-1974		<b>US896</b>
5.0L V8 305 CID	1981	Custom, Deluxe	<b>US1121</b>	4.8L L6 292 CID	1975-1977		<b>US1137</b>
5.0L V8 305 CID	1981	Custom, Deluxe; High performance	<b>US1121H</b>	4.8L L6 292 CID	1975-1977	High performance	<b>US1137H</b>
5.0L V8 305 CID	1982	Custom, Scottsdale, Silverado	<b>US1121</b>	4.8L L6 292 CID	1978-1979		<b>US5030</b>
5.0L V8 305 CID	1982	Custom, Scottsdale, Silverado; High performance	<b>US1121H</b>	4.8L L6 292 CID	1980	Custom Deluxe, Scottsdale, Silverado	<b>US5030</b>
5.0L V8 305 CID	1983	Custom, Silverado	<b>US1121</b>	4.8L L6 292 CID	1981	Custom, Deluxe	<b>US5030</b>
5.0L V8 305 CID	1983	Custom, Silverado; High performance	<b>US1121H</b>	4.8L L6 292 CID	1982	Custom, Scottsdale, Silverado	<b>US5030</b>
5.0L V8 305 CID	1984-1986	Custom, Scottsdale, Silverado	<b>US1121</b>	4.8L L6 292 CID	1982	Custom, Scottsdale, Silverado	<b>US5030</b>
5.0L V8 305 CID	1984-1986	Custom, Scottsdale, Silverado; High performance	<b>US1121H</b>	4.8L L6 4786cc 292 CID	1973-1974		<b>US896</b>
5.7L V8 350 CID	1975-1976		<b>US1109</b>	4.8L L6 4801cc 292 CID	1967-1974		<b>US896</b>
5.7L V8 350 CID	1975-1976	High performance	<b>US1109H</b>	5.0L V8 305 CID	1977-1979		<b>US1121</b>
5.7L V8 350 CID	1977-1979		<b>US1121</b>	5.0L V8 305 CID	1977-1979	High performance	<b>US1121H</b>
5.7L V8 350 CID	1977-1979	High performance	<b>US1121H</b>	5.0L V8 305 CID	1980	Custom Deluxe, Scottsdale, Silverado	<b>US1121</b>
5.7L V8 350 CID	1980	Cheyenne, Custom Deluxe, Scottsdale, Silverado	<b>US1121</b>	5.0L V8 305 CID	1980	Custom Deluxe, Scottsdale, Silverado; High performance	<b>US1121H</b>
5.7L V8 350 CID	1980	Cheyenne, Custom Deluxe, Scottsdale, Silverado; High performance	<b>US1121H</b>	5.0L V8 305 CID	1981	Custom, Deluxe	<b>US1121</b>
5.7L V8 350 CID	1981	Custom, Deluxe	<b>US1121</b>	5.0L V8 305 CID	1981	Custom, Deluxe; High performance	<b>US1121H</b>
5.7L V8 350 CID	1981	Custom, Deluxe; High performance	<b>US1121H</b>	5.0L V8 305 CID	1982	Custom, Scottsdale, Silverado	<b>US1121</b>
5.7L V8 350 CID	1982	Custom, Scottsdale, Silverado	<b>US1121</b>	5.0L V8 305 CID	1982	Custom, Scottsdale, Silverado; High performance	<b>US1121H</b>
5.7L V8 350 CID	1982	Custom, Scottsdale, Silverado; High performance	<b>US1121H</b>	5.0L V8 305 CID	1983	Custom, Silverado	<b>US1121</b>
5.7L V8 350 CID	1982	Custom, Scottsdale, Silverado; High performance	<b>US1121H</b>	5.0L V8 305 CID	1983	Custom, Silverado; High performance	<b>US1121H</b>
5.7L V8 350 CID	1983	Custom, Silverado	<b>US1121</b>	5.0L V8 305 CID	1984-1986	Custom, Scottsdale, Silverado	<b>US1121</b>
5.7L V8 350 CID	1983	Custom, Silverado; High performance	<b>US1121H</b>	5.0L V8 305 CID	1984-1986	Custom, Scottsdale, Silverado; High performance	<b>US1121H</b>
5.7L V8 350 CID	1984-1986	Custom, Scottsdale, Silverado	<b>US1121</b>	5.0L V8 307 CID	1968-1972		<b>US898</b>
5.7L V8 350 CID	1984-1986	Custom, Scottsdale, Silverado; High performance	<b>US1121H</b>	5.0L V8 307 CID	1968-1972	High performance	<b>US898H</b>
5.7L V8 350 CID	1984-1986	Custom, Scottsdale, Silverado; High performance	<b>US1121H</b>	5.0L V8 5031cc 307 CID	1968-1972		<b>US898</b>
5.7L V8 5700cc 350 CID	1985	Mexican Application	<b>US1121</b>	5.0L V8 5031cc 307 CID	1968-1972	High performance	<b>US898H</b>
5.7L V8 5700cc 350 CID	1987	Mexican Application	<b>US1121</b>	5.3L V8 5358cc 327 CID	1967-1969		<b>US898</b>
6.2L V8 379 CID	1982	Custom, Scottsdale, Silverado	<b>US5008</b>	5.3L V8 5358cc 327 CID	1967-1969	High performance	<b>US898H</b>
6.2L V8 379 CID	1983	Custom, Silverado	<b>US5008</b>	5.4L V8 327 CID	1968		<b>US898</b>
6.2L V8 379 CID	1984-1986	Custom, Scottsdale, Silverado	<b>US5008</b>	5.4L V8 327 CID	1968	High performance	<b>US898H</b>
6.6L V8 400 CID	1976		<b>US1109</b>	5.7L V8 350 CID	1969-1972		<b>US898</b>
6.6L V8 400 CID	1976	High performance	<b>US1109H</b>	5.7L V8 350 CID	1969-1972	High performance	<b>US898H</b>
6.6L V8 400 CID	1977-1979		<b>US1121</b>	5.7L V8 350 CID	1975-1976		<b>US1109</b>
6.6L V8 400 CID	1977-1979	High performance	<b>US1121H</b>	5.7L V8 350 CID	1975-1976	High performance	<b>US1109H</b>
6.6L V8 400 CID	1980	Cheyenne, Custom Deluxe, Scottsdale, Silverado	<b>US1121</b>	5.7L V8 350 CID	1977-1979		<b>US1121</b>
6.6L V8 400 CID	1980	Cheyenne, Custom Deluxe, Scottsdale, Silverado; High performance	<b>US1121H</b>	5.7L V8 350 CID	1977-1979	High performance	<b>US1121H</b>
6.6L V8 400 CID	1980	Cheyenne, Custom Deluxe, Scottsdale, Silverado; High performance	<b>US1121H</b>	5.7L V8 350 CID	1980	Custom Deluxe, Scottsdale, Silverado; High performance	<b>US1121H</b>
7.4L V8 454 CID	1975-1979		<b>US1002</b>	5.7L V8 350 CID	1981	Custom, Deluxe	<b>US1121</b>
7.4L V8 454 CID	1975-1979	High performance	<b>US1002H</b>	5.7L V8 350 CID	1981	Custom, Deluxe; High performance	<b>US1121H</b>
7.4L V8 454 CID	1980	Cheyenne, Custom Deluxe, Scottsdale, Silverado	<b>US1002</b>	5.7L V8 350 CID	1982	Custom, Scottsdale, Silverado	<b>US1121</b>
7.4L V8 454 CID	1980	Cheyenne, Custom Deluxe, Scottsdale, Silverado; High performance	<b>US1002H</b>	5.7L V8 350 CID	1982	Custom, Scottsdale, Silverado; High performance	<b>US1121H</b>
7.4L V8 454 CID	1981	Custom, Deluxe	<b>US1002</b>	5.7L V8 350 CID	1983	Custom, Silverado	<b>US1121</b>
7.4L V8 454 CID	1981	Custom, Deluxe; High performance	<b>US1002H</b>	5.7L V8 350 CID	1983	Custom, Silverado; High performance	<b>US1121H</b>
7.4L V8 454 CID	1982	Custom, Scottsdale, Silverado	<b>US1002</b>	5.7L V8 350 CID	1984-1986	Custom, Scottsdale, Silverado	<b>US1121</b>
7.4L V8 454 CID	1982	Custom, Scottsdale, Silverado; High performance	<b>US1002H</b>	5.7L V8 350 CID	1984-1986	Custom, Scottsdale, Silverado; High performance	<b>US1121H</b>
7.4L V8 454 CID	1982	Custom, Scottsdale, Silverado; High performance	<b>US1002H</b>	5.7L V8 5736cc 350 CID	1969-1972		<b>US898</b>
				5.7L V8 5736cc 350 CID	1969-1972	High performance	<b>US898H</b>
				6.2L V8 379 CID	1982	Custom, Scottsdale, Silverado	<b>US5008</b>
				6.2L V8 379 CID	1983	Custom, Silverado	<b>US5008</b>



Engine	Years	Application Description	USMW	Engine	Years	Application Description	USMW
<b>CHEVROLET (cont'd.)</b>				<b>CHEVROLET (cont'd.)</b>			
<b>C20 SUBURBAN (cont'd.)</b>				<b>C30 PICKUP</b>			
6.2L V8 379 CID	1984-1986	Custom, Scottsdale, Silverado	US5008	4.3L L6 4278cc 261 CID	1961-1962		US898
6.5L V8 396 CID	1968-1969		US981	4.3L L6 4278cc 261 CID	1961-1962	High performance	US898H
6.5L V8 6489cc 396 CID	1968-1969		US981	4.6L V8 4638cc 283 CID	1960-1967		US898
6.6L V8 400 CID	1976		US1109	4.6L V8 4638cc 283 CID	1960-1967	High performance	US898H
6.6L V8 400 CID	1976	High performance	US1109H	4.8L L6 292 CID	1968-1974		US896
6.6L V8 400 CID	1977-1979		US1121	4.8L L6 4786cc 292 CID	1973-1974		US896
6.6L V8 400 CID	1977-1979	High performance	US1121H	4.8L L6 4801cc 292 CID	1965-1974		US896
6.6L V8 400 CID	1980	Custom Deluxe, Scottsdale, Silverado	US1121	5.0L V8 307 CID	1968-1972		US898
6.6L V8 400 CID	1980	Custom Deluxe, Scottsdale, Silverado; High performance	US1121H	5.0L V8 307 CID	1968-1972	High performance	US898H
6.6L V8 402 CID	1970-1972		US981	5.0L V8 5031cc 307 CID	1968-1972		US898
6.6L V8 6588cc 402 CID	1970-1972		US981	5.0L V8 5031cc 307 CID	1968-1972	High performance	US898H
7.4L V8 454 CID	1975-1979		US1002	5.3L V8 5358cc 327 CID	1966-1969		US898
7.4L V8 454 CID	1975-1979	High performance	US1002H	5.3L V8 5358cc 327 CID	1966-1969	High performance	US898H
7.4L V8 454 CID	1980	Custom Deluxe, Scottsdale, Silverado	US1002	5.4L V8 327 CID	1968		US898
7.4L V8 454 CID	1980	Custom Deluxe, Scottsdale, Silverado; High performance	US1002H	5.4L V8 327 CID	1968	High performance	US898H
7.4L V8 454 CID	1981	Custom, Deluxe	US1002	5.7L V8 350 CID	1969-1972		US898
7.4L V8 454 CID	1981	Custom, Deluxe; High performance	US1002H	5.7L V8 350 CID	1969-1972	High performance	US898H
7.4L V8 454 CID	1982	Custom, Scottsdale, Silverado	US1002	5.7L V8 5704cc 348 CID	1960-1961		US898
7.4L V8 454 CID	1982	Custom, Scottsdale, Silverado; High performance	US1002H	5.7L V8 5704cc 348 CID	1960-1961	High performance	US898H
7.4L V8 454 CID	1982	Custom, Scottsdale, Silverado; High performance	US1002H	5.7L V8 5736cc 350 CID	1969-1972		US898
7.4L V8 454 CID	1983	Custom, Silverado	US1002	5.7L V8 5736cc 350 CID	1969-1972	High performance	US898H
7.4L V8 454 CID	1983	Custom, Silverado; High performance	US1002H	6.5L V8 396 CID	1968-1969		US981
7.4L V8 454 CID	1984-1986	Custom, Scottsdale, Silverado	US1002	6.5L V8 6489cc 396 CID	1968-1969		US981
7.4L V8 454 CID	1984-1986	Custom, Scottsdale, Silverado; High performance	US1002H	6.6L V8 402 CID	1970-1972		US981
7.4L V8 454 CID	1984-1986	Custom, Scottsdale, Silverado; High performance	US1002H	6.6L V8 6588cc 402 CID	1970-1972		US981
<b>C25</b>				<b>C35</b>			
5.7L V8 5700cc 350 CID	1992-1995	Mexican Application	US5049	4.8L L6 4800cc 292 CID	1987	Mexican Application	US5030
5.7L V8 5700cc 350 CID	1996-1997	Mexican Application	US5077	5.7L V8 5700cc 350 CID	1987	Mexican Application	US1121
<b>C30</b>				<b>C50</b>			
4.1L L6 250 CID	1980	Cheyenne, Custom Deluxe, Scottsdale, Silverado	US1107	6.0L V8 5999cc 366 CID	1966-1967	Without threaded hub	US5084
4.8L L6 292 CID	1975-1977		US1137	6.0L V8 5999cc 366 CID	1966-1978		US861
4.8L L6 292 CID	1975-1977	High performance	US1137H	7.0L V8 6998cc 427 CID	1969-1978		US861
4.8L L6 292 CID	1978-1979		US5030	<b>C60</b>			
4.8L L6 292 CID	1980	Cheyenne, Custom Deluxe, Scottsdale, Silverado	US5030	6.0L V8 366 CID	1980-1990	Without threaded hub	US5084
4.8L L6 292 CID	1981	Custom, Deluxe	US5030	6.0L V8 366 CID	1990	With threaded hub for fan clutch	US5078
4.8L L6 292 CID	1982	Custom, Scottsdale, Silverado	US5030	6.0L V8 5999cc 366 CID	1966-1967	Without threaded hub	US5084
4.8L L6 292 CID	1983	Custom, Silverado	US5030	6.0L V8 5999cc 366 CID	1966-1978		US861
4.8L L6 292 CID	1984-1986	Custom, Scottsdale, Silverado	US5030	7.0L V8 427 CID	1990	With threaded hub for fan clutch	US5078
5.0L V8 305 CID	1978-1979		US1121	7.0L V8 427 CID	1990	Without threaded hub	US5084
5.0L V8 305 CID	1978-1979	High performance	US1121H	7.0L V8 6998cc 427 CID	1969-1978		US861
5.7L V8 350 CID	1975-1976		US1109	7.8L V6 7828cc 478 CID	1967-1973		US835
5.7L V8 350 CID	1975-1976	High performance	US1109H	<b>C60 KODIAK</b>			
5.7L V8 350 CID	1977-1979		US1121	6.0L V8 366 CID	1990	Without threaded hub	US5084
5.7L V8 350 CID	1977-1979	High performance	US1121H	6.0L V8 366 CID	1990-1996	With threaded hub for fan clutch	US5078
5.7L V8 350 CID	1980	Cheyenne, Custom Deluxe, Scottsdale, Silverado	US1121	7.0L V8 6998cc 427 CID	1990	Without threaded hub	US5084
5.7L V8 350 CID	1980	Cheyenne, Custom Deluxe, Scottsdale, Silverado; High performance	US1121H	7.0L V8 6998cc 427 CID	1990-1996	With threaded hub for fan clutch	US5078
5.7L V8 350 CID	1981	Custom, Deluxe	US1121	<b>C70</b>			
5.7L V8 350 CID	1981	Custom, Deluxe; High performance	US1121H	6.0L V8 366 CID	1980-1990	Without threaded hub	US5084
5.7L V8 350 CID	1982	Custom, Scottsdale, Silverado	US1121	6.0L V8 366 CID	1990	With threaded hub for fan clutch	US5078
5.7L V8 350 CID	1982	Custom, Scottsdale, Silverado; High performance	US1121H	7.0L V8 427 CID	1980-1990	Without threaded hub	US5084
5.7L V8 350 CID	1983	Custom, Silverado	US1121	7.0L V8 427 CID	1990	With threaded hub for fan clutch	US5078
5.7L V8 350 CID	1983	Custom, Silverado; High performance	US1121H	7.4L V8 454 CID	1980	Without threaded hub	US5084
5.7L V8 350 CID	1984-1986	Custom, Scottsdale, Silverado	US1121	<b>C70 KODIAK</b>			
5.7L V8 350 CID	1984-1986	Custom, Scottsdale, Silverado; High performance	US1121H	6.0L V8 366 CID	1990	Without threaded hub	US5084
5.7L V8 5700cc 350 CID	1979-1985	Mexican Application	US1121	6.0L V8 366 CID	1990-1996	With threaded hub for fan clutch	US5078
6.2L V8 379 CID	1982	Custom, Scottsdale, Silverado	US5008	7.0L V8 6998cc 427 CID	1990	Without threaded hub	US5084
6.2L V8 379 CID	1983	Custom, Silverado	US5008	7.0L V8 6998cc 427 CID	1990-1996	With threaded hub for fan clutch	US5078
6.2L V8 379 CID	1984-1986	Custom, Scottsdale, Silverado	US5008	<b>C1405</b>			
6.6L V8 400 CID	1976		US1109	4.7L V8 4738cc 283 CID	1965-1966	Mexican Application	US898
6.6L V8 400 CID	1976	High performance	US1109H	4.8L L6 4800cc 292 CID	1965-1966	Mexican Application	US896
6.6L V8 400 CID	1977-1979		US1121	<b>C1500</b>			
6.6L V8 400 CID	1977-1979	High performance	US1121H	4.1L L6 4100cc 250 CID	1994-1997	Mexican Application	US895
7.4L V8 454 CID	1975-1979		US1002	4.1L L6 4100cc 250 CID	1998	Mexican Application	US5030
7.4L V8 454 CID	1975-1979	High performance	US1002H	4.3L V6 262 CID	1988-1989	Cheyenne, Scottsdale, Silverado	US5049
7.4L V8 454 CID	1980	Cheyenne, Custom Deluxe, Scottsdale, Silverado	US1002	4.3L V6 262 CID	1988-1989	Cheyenne, Scottsdale, Silverado; High performance	US5049H
7.4L V8 454 CID	1980	Cheyenne, Custom Deluxe, Scottsdale, Silverado; High performance	US1002H	4.3L V6 262 CID	1990-1992	Cheyenne, Scottsdale, Silverado, WT	US5049
7.4L V8 454 CID	1981	Custom, Deluxe	US1002	4.3L V6 262 CID	1990-1992	Cheyenne, Scottsdale, Silverado, WT; High performance	US5049H
7.4L V8 454 CID	1981	Custom, Deluxe; High performance	US1002H	4.3L V6 262 CID	1993	Cheyenne, Silverado, WT	US5049
7.4L V8 454 CID	1982	Custom, Scottsdale, Silverado	US1002	4.3L V6 262 CID	1993	Cheyenne, Silverado, WT; High performance	US5049H
7.4L V8 454 CID	1982	Custom, Scottsdale, Silverado; High performance	US1002H	4.3L V6 262 CID	1994-1995	Base, Cheyenne, Silverado, WT	US5049
7.4L V8 454 CID	1983	Custom, Silverado	US1002	4.3L V6 262 CID	1994-1995	Base, Cheyenne, Silverado, WT; High performance	US5049H
7.4L V8 454 CID	1983	Custom, Silverado; High performance	US1002H	4.3L V6 262 CID	1996-1997	Base, Cheyenne, Silverado, WT	US5077
7.4L V8 454 CID	1984-1986	Custom, Scottsdale, Silverado	US1002	4.3L V6 262 CID	1996-1997	Base, Cheyenne, Silverado, WT; High performance	US5077H
7.4L V8 454 CID	1984-1986	Custom, Scottsdale, Silverado; High performance	US1002H	4.3L V6 262 CID	1998	Cheyenne, Silverado, WT	US5077
				4.3L V6 262 CID	1998	Cheyenne, Silverado, WT; High performance	US5077H
				4.3L V6 262 CID	1999	Mexican Application	US5077
				5.0L V8 305 CID	1988-1989	Cheyenne, Scottsdale, Silverado	US5049

WATER PUMPS



# WATER PUMP APPLICATION GUIDE



Engine	Years	Application Description	USMWW	Engine	Years	Application Description	USMWW
<b>CHEVROLET (cont'd.)</b>				<b>CHEVROLET (cont'd.)</b>			
<b>C1500 (cont'd.)</b>				<b>C2500 (cont'd.)</b>			
5.0L V8 305 CID	1988-1989	Cheyenne, Scottsdale, Silverado; High performance	US5049H	4.3L V6 262 CID	1988-1992	Cheyenne, Scottsdale, Silverado; High performance	US5049H
5.0L V8 305 CID	1990-1991	Cheyenne, Scottsdale, Silverado, WT	US5049	4.3L V6 262 CID	1993	Cheyenne, Silverado	US5049
5.0L V8 305 CID	1990-1991	Cheyenne, Scottsdale, Silverado, WT; High performance	US5049H	4.3L V6 262 CID	1993	Cheyenne, Silverado; High performance	US5049H
5.0L V8 305 CID	1992	Cheyenne, Scottsdale, Silverado	US5049	4.3L V6 262 CID	1994-1995	Base, Cheyenne, Silverado, WT	US5049
5.0L V8 305 CID	1992	Cheyenne, Scottsdale, Silverado; High performance	US5049H	4.3L V6 262 CID	1994-1995	Base, Cheyenne, Silverado, WT; High performance	US5049H
5.0L V8 305 CID	1993	Cheyenne, Silverado, WT	US5049	5.0L V8 305 CID	1988-1992	Cheyenne, Scottsdale, Silverado	US5049
5.0L V8 305 CID	1993	Cheyenne, Silverado, WT; High performance	US5049H	5.0L V8 305 CID	1988-1992	Cheyenne, Scottsdale, Silverado; High performance	US5049H
5.0L V8 305 CID	1994-1995	Base, Cheyenne, Silverado, WT	US5049	5.0L V8 305 CID	1993	Cheyenne, Silverado	US5049
5.0L V8 305 CID	1994-1995	Base, Cheyenne, Silverado, WT; High performance	US5049H	5.0L V8 305 CID	1993	Cheyenne, Silverado; High performance	US5049H
5.0L V8 305 CID	1996-1997	Base, Cheyenne, Silverado, WT	US5077	5.0L V8 305 CID	1994-1995	Base, Cheyenne, Silverado, WT	US5049
5.0L V8 305 CID	1996-1997	Base, Cheyenne, Silverado, WT; High performance	US5077H	5.0L V8 305 CID	1994-1995	Base, Cheyenne, Silverado, WT; High performance	US5049H
5.0L V8 305 CID	1998	Cheyenne, Silverado, WT	US5077	5.0L V8 305 CID	1996-1997	Base, Cheyenne, Silverado	US5077
5.0L V8 305 CID	1998	Cheyenne, Silverado, WT; High performance	US5077H	5.0L V8 305 CID	1996-1997	Base, Cheyenne, Silverado; High performance	US5077H
5.0L V8 305 CID	1999	LS	US5077	5.0L V8 305 CID	1998	Cheyenne, Silverado, WT	US5077
5.0L V8 305 CID	1999	LS; High performance	US5077H	5.0L V8 305 CID	1998	Cheyenne, Silverado, WT; High performance	US5077H
5.7L V8 350 CID	1988-1989	Cheyenne, Scottsdale, Silverado	US5049	5.7L V8 350 CID	1988-1992	Cheyenne, Scottsdale, Silverado	US5049
5.7L V8 350 CID	1988-1989	Cheyenne, Scottsdale, Silverado; High performance	US5049H	5.7L V8 350 CID	1988-1992	Cheyenne, Scottsdale, Silverado; High performance	US5049H
5.7L V8 350 CID	1990-1991	Cheyenne, Scottsdale, Silverado, WT	US5049	5.7L V8 350 CID	1993	Cheyenne, Silverado	US5049
5.7L V8 350 CID	1990-1991	Cheyenne, Scottsdale, Silverado, WT; High performance	US5049H	5.7L V8 350 CID	1993	Cheyenne, Silverado; High performance	US5049H
5.7L V8 350 CID	1992	Cheyenne, Scottsdale, Silverado, WT; 6.9" HUB HEIGHT	US5049	5.7L V8 350 CID	1994-1995	Base, Cheyenne, Silverado, WT	US5049
5.7L V8 350 CID	1992	Cheyenne, Scottsdale, Silverado, WT; 6.9" HUB HEIGHT, High performance	US5049H	5.7L V8 350 CID	1994-1995	Base, Cheyenne, Silverado, WT; High performance	US5049H
5.7L V8 350 CID	1992	Cheyenne, Scottsdale, Silverado, WT; 5.8" HUB HEIGHT	US5073	5.7L V8 350 CID	1996-1997	Base, Cheyenne, Silverado	US5077
5.7L V8 350 CID	1993	Cheyenne, Silverado, WT	US5049	5.7L V8 350 CID	1996-1997	Base, Cheyenne, Silverado; High performance	US5077H
5.7L V8 350 CID	1993	Cheyenne, Silverado, WT; High performance	US5049H	5.7L V8 350 CID	1998	Cheyenne, Silverado, WT	US5077
5.7L V8 350 CID	1994-1995	Base, Cheyenne, Silverado, WT	US5049	5.7L V8 350 CID	1998	Cheyenne, Silverado, WT; High performance	US5077H
5.7L V8 350 CID	1994-1995	Base, Cheyenne, Silverado, WT; High performance	US5049H	5.7L V8 350 CID	1999-2000	Base, LS	US5077
5.7L V8 350 CID	1996-1997	Base, Cheyenne, Silverado, WT	US5077	5.7L V8 350 CID	1999-2000	Base, LS; High performance	US5077H
5.7L V8 350 CID	1996-1997	Base, Cheyenne, Silverado, WT; High performance	US5077H	5.7L V8 5700cc 350 CID	1988-1991	Mexican Application	US5049
5.7L V8 350 CID	1998	Cheyenne, Silverado, WT	US5077	5.7L V8 5700cc 350 CID	1998	Mexican Application	US5077
5.7L V8 350 CID	1998	Cheyenne, Silverado, WT; High performance	US5077H	5.7L V8 5737cc 350 CID	2000	Mexican Application	US5087
5.7L V8 350 CID	1999	LS	US5077	6.2L V8 379 CID	1988-1992	Cheyenne, Scottsdale, Silverado	US5062
5.7L V8 350 CID	1999	LS; High performance	US5077H	6.2L V8 379 CID	1993	Cheyenne, Silverado	US5062
5.7L V8 5700cc 350 CID	1988-1991	Mexican Application	US5049	6.5L V8 395 CID	1992-1993	Cheyenne, Silverado	US5062
5.7L V8 5737cc 350 CID	2000	Mexican Application	US5077	6.5L V8 395 CID	1994-1995	Base, Cheyenne, Silverado, WT	US5062
6.2L V8 379 CID	1988-1989	Cheyenne, Scottsdale, Silverado	US5062	6.5L V8 395 CID	1996	Base, Cheyenne, Silverado; Early	US5062
6.2L V8 379 CID	1990-1992	Cheyenne, Scottsdale, Silverado, WT	US5062	6.5L V8 395 CID	1996	Base, Cheyenne, Silverado; Late	US5074
6.2L V8 379 CID	1993	Cheyenne, Silverado, WT	US5062	6.5L V8 395 CID	1997	Base, Cheyenne, Silverado	US5074
6.5L V8 395 CID	1994-1995	Base, Cheyenne, Silverado, WT	US5062	6.5L V8 395 CID	1998	Cheyenne, Silverado, WT	US5074
6.5L V8 395 CID	1996	Base, Cheyenne, Silverado, WT; Early	US5062	6.5L V8 395 CID	1999	Base, LS; Bolt on pulley	US5074
6.5L V8 395 CID	1996	Base, Cheyenne, Silverado, WT; Late	US5074	6.5L V8 395 CID	1999-2000	Base, LS	US5086
6.5L V8 395 CID	1997	Base, Cheyenne, Silverado, WT	US5074	7.4L V8 454 CID	1991-1993	Cheyenne, Silverado	US5038
6.5L V8 395 CID	1998	Cheyenne, Silverado, WT	US5074	7.4L V8 454 CID	1991-1993	Cheyenne, Silverado; High performance	US5038H
7.4L V8 454 CID	1990	454 SS, Cheyenne, Scottsdale, Silverado, WT	US5038	7.4L V8 454 CID	1994-1995	Base, Cheyenne, Silverado, WT	US5038
7.4L V8 454 CID	1990	454 SS, Cheyenne, Scottsdale, Silverado, WT; High performance	US5038H	7.4L V8 454 CID	1994-1995	Base, Cheyenne, Silverado, WT; High performance	US5038H
7.4L V8 454 CID	1991-1992	454 SS, Cheyenne, Silverado, WT	US5038	7.4L V8 454 CID	1996-1997	Base, Cheyenne, Silverado	US5038
7.4L V8 454 CID	1991-1993	454 SS, Cheyenne, Silverado, WT; High performance	US5038H	7.4L V8 454 CID	1996-1997	Base, Cheyenne, Silverado; High performance	US5038H
7.4L V8 454 CID	1993	454 SS	US5038	7.4L V8 454 CID	1998	Cheyenne, Silverado, WT	US5038
<b>C1500 SUBURBAN</b>				<b>C2500 SUBURBAN</b>			
5.7L V8 350 CID	1992	Base, Silverado; 6.9" HUB HEIGHT	US5049	5.7L V8 350 CID	1992	Base, Silverado; 6.9" HUB HEIGHT	US5049
5.7L V8 350 CID	1992	Base, Silverado; 6.9" HUB HEIGHT, High performance	US5049H	5.7L V8 350 CID	1992	Base, Silverado; 6.9" HUB HEIGHT, High performance	US5049H
5.7L V8 350 CID	1992	Base, Silverado; 5.8" HUB HEIGHT	US5073	5.7L V8 350 CID	1992	Base, Silverado; 5.8" HUB HEIGHT	US5073
5.7L V8 350 CID	1993-1994	Base, Silverado	US5049	5.7L V8 350 CID	1993-1994	Base, Silverado	US5049
5.7L V8 350 CID	1993-1994	Base, Silverado; High performance	US5049H	5.7L V8 350 CID	1993-1994	Base, Silverado; High performance	US5049H
5.7L V8 350 CID	1995	Base, LS, LT	US5049	5.7L V8 350 CID	1995	Base, LS, LT	US5049
5.7L V8 350 CID	1995	Base, LS, LT; High performance	US5049H	5.7L V8 350 CID	1995	Base, LS, LT; High performance	US5049H
5.7L V8 350 CID	1996-1997	Base, LS, LT	US5077	5.7L V8 350 CID	1996-1997	Base, LS, LT	US5077
5.7L V8 350 CID	1996-1997	Base, LS, LT; High performance	US5077H	5.7L V8 350 CID	1996-1997	Base, LS, LT; High performance	US5077H
5.7L V8 350 CID	1998	Base, LS	US5077	5.7L V8 350 CID	1998-1999	Base, LS	US5077
5.7L V8 350 CID	1998-1999	Base, LS; High performance	US5077H	5.7L V8 350 CID	1998-1999	Base, LS; High performance	US5077H
5.7L V8 350 CID	1999	Base, LS, LT	US5077	6.5L V8 395 CID	1994	Base, Silverado	US5062
6.5L V8 395 CID	1995	Base, LS, LT	US5062	6.5L V8 395 CID	1995	Base, LS, LT	US5062
6.5L V8 395 CID	1996	Base, LS, LT; Early	US5062	6.5L V8 395 CID	1996	Base, LS, LT; Early	US5062
6.5L V8 395 CID	1996	Base, LS, LT; Late	US5074	6.5L V8 395 CID	1996	Base, LS, LT; Late	US5074
6.5L V8 395 CID	1997	Base, LS, LT	US5074	6.5L V8 395 CID	1997	Base, LS, LT	US5074
6.5L V8 395 CID	1998	Base, LS	US5074	6.5L V8 395 CID	1998	Base, LS	US5074
6.5L V8 395 CID	1999	Base, LS, LT; Bolt on pulley	US5074	6.5L V8 395 CID	1999	Base, LS; Bolt on pulley	US5074
6.5L V8 395 CID	1999	Base, LS, LT	US5086	6.5L V8 395 CID	1999	Base, LS	US5086
<b>C2500</b>				<b>C2500</b>			
4.3L V6 262 CID	1988-1992	Cheyenne, Scottsdale, Silverado	US5049	4.3L V6 262 CID	1988-1992	Cheyenne, Scottsdale, Silverado	US5049



Engine	Years	Application Description	USMW	Engine	Years	Application Description	USMW
<b>CHEVROLET (cont'd.)</b>				<b>CHEVROLET (cont'd.)</b>			
<b>C2500 SUBURBAN (cont'd.)</b>				<b>CAMARO (cont'd.)</b>			
7.4L V8 454 CID	1992-1994	Base, Silverado; High performance	US5038H	3.8L V6 229 CID	1981	Berlinetta, Sport	US1121
7.4L V8 454 CID	1995-1997	Base, LS, LT	US5038	3.8L V6 229 CID	1981	Berlinetta, Sport; High performance	US1121H
7.4L V8 454 CID	1995-1997	Base, LS, LT; High performance	US5038H	3.8L V6 3800cc 231 CID	1980	Base, Berlinetta, Rally Sport	US1018
7.4L V8 454 CID	1998-1999	Base, LS	US5038	3.8L V6 3800cc 231 CID	1980	Base, Berlinetta, Rally Sport; High performance	US1018H
7.4L V8 454 CID	1998-1999	Base, LS; High performance	US5038H	3.8L V6 3800cc 231 CID	1981	Berlinetta, Sport	US1018
<b>C3500</b>				3.8L V6 3800cc 231 CID	1981	Berlinetta, Sport; High performance	US1018H
5.7L V8 350 CID	1988-1992	Cheyenne, Scottsdale, Silverado	US5049	3.8L V6 3800cc 231 CID	1995	Base	US5050
5.7L V8 350 CID	1988-1992	Cheyenne, Scottsdale, Silverado; High performance	US5049H	3.8L V6 3800cc 231 CID	1996-1997	Base, RS	US5075
5.7L V8 350 CID	1993	Cheyenne, Silverado	US5049	3.8L V6 3800cc 231 CID	1998-2002	Base	US5075
5.7L V8 350 CID	1993	Cheyenne, Silverado; High performance	US5049H	4.1L L6 250 CID	1975-1979		US1107
5.7L V8 350 CID	1994-1995	Base, Cheyenne, Silverado	US5049	4.4L V8 267 CID	1980	Base, Berlinetta, Rally Sport	US1121
5.7L V8 350 CID	1994-1995	Base, Cheyenne, Silverado; High performance	US5049H	4.4L V8 267 CID	1980	Base, Berlinetta, Rally Sport; High performance	US1121H
5.7L V8 350 CID	1996-1997	Base, Cheyenne, Silverado	US5077	4.4L V8 267 CID	1981	Berlinetta, Sport	US1121
5.7L V8 350 CID	1996-1997	Base, Cheyenne, Silverado; High performance	US5077H	4.4L V8 305 CID	1976	Berlinetta, Sport; High performance	US1121H
5.7L V8 350 CID	1998	Cheyenne, Silverado	US5077	5.0L V8 305 CID	1976	High performance	US1109H
5.7L V8 350 CID	1998	Cheyenne, Silverado; High performance	US5077H	5.0L V8 305 CID	1977-1979		US1121
5.7L V8 350 CID	1999-2000	Base, LS	US5077	5.0L V8 305 CID	1977-1979	High performance	US1121H
5.7L V8 350 CID	1999-2000	Base, LS; High performance	US5077H	5.0L V8 305 CID	1980	Base, Berlinetta, Rally Sport, Z28	US1121
5.7L V8 5700cc 350 CID	1988-1994	Mexican Application	US5049	5.0L V8 305 CID	1980	Base, Berlinetta, Rally Sport, Z28; High performance	US1121H
6.2L V8 379 CID	1988-1992	Cheyenne, Scottsdale, Silverado	US5062	5.0L V8 305 CID	1981	Berlinetta, Sport, Z28	US1121
6.2L V8 379 CID	1993	Cheyenne, Silverado	US5062	5.0L V8 305 CID	1981	Berlinetta, Sport, Z28; High performance	US1121H
6.5L V8 395 CID	1992	Cheyenne, Scottsdale, Silverado	US5062	5.0L V8 305 CID	1982	Berlinetta, Sport, Z28, Z28 Indianapolis 500 Pace Car	US1121
6.5L V8 395 CID	1993	Cheyenne, Silverado	US5062	5.0L V8 305 CID	1982	Berlinetta, Sport, Z28, Z28 Indianapolis 500 Pace Car; High performance	US1121H
6.5L V8 395 CID	1994-1995	Base, Cheyenne, Silverado	US5062	5.0L V8 305 CID	1983-1984	Berlinetta, Sport, Z28	US1121
6.5L V8 395 CID	1996	Base, Cheyenne, Silverado; Early	US5062	5.0L V8 305 CID	1983-1985	Berlinetta, Sport, Z28; High performance	US1121H
6.5L V8 395 CID	1996	Base, Cheyenne, Silverado; Late	US5074	5.0L V8 305 CID	1985-1986	Berlinetta, Iroc-Z, Sport, Z28	US1121
6.5L V8 395 CID	1997	Base, Cheyenne, Silverado	US5074	5.0L V8 305 CID	1986	Berlinetta, Iroc-Z, Sport, Z28; High performance	US1121H
6.5L V8 395 CID	1998	Cheyenne, Silverado	US5074	5.0L V8 305 CID	1987	Iroc-Z, LT, Sport, Z28	US1121
6.5L V8 395 CID	1999	Base, LS; Bolt on pulley	US5074	5.0L V8 305 CID	1987	Iroc-Z, LT, Sport, Z28; High performance	US1121H
6.5L V8 395 CID	1999-2000	Base, LS	US5086	5.0L V8 305 CID	1988	Base, Iroc-Z	US5049
7.4L V8 454 CID	1988-1990	Cheyenne, Scottsdale, Silverado; High performance	US5038H	5.0L V8 305 CID	1988	Base, Iroc-Z; High performance	US5049H
7.4L V8 454 CID	1988-1992	Cheyenne, Scottsdale, Silverado	US5038	5.0L V8 305 CID	1989-1990	Iroc-Z, RS	US5049
7.4L V8 454 CID	1991-1993	Cheyenne, Silverado; High performance	US5038H	5.0L V8 305 CID	1989-1990	Iroc-Z, RS; High performance	US5049H
7.4L V8 454 CID	1993	Cheyenne, Silverado	US5038	5.0L V8 305 CID	1991	RS, Z28	US5049
7.4L V8 454 CID	1994-1997	Base, Cheyenne, Silverado	US5038	5.0L V8 305 CID	1991	RS, Z28; High performance	US5049H
7.4L V8 454 CID	1994-1997	Base, Cheyenne, Silverado; High performance	US5038H	5.0L V8 305 CID	1992	RS, RS Heritage Edition, Z28, Z28 Heritage Edition	US5049
7.4L V8 454 CID	1998	Cheyenne, Silverado	US5038	5.0L V8 305 CID	1992	RS, RS Heritage Edition, Z28, Z28 Heritage Edition; High performance	US5049H
7.4L V8 454 CID	1998	Cheyenne, Silverado; High performance	US5038H	5.0L V8 307 CID	1969-1972		US898
7.4L V8 454 CID	1999-2000	Base, LS	US5038	5.0L V8 307 CID	1969-1972	High performance	US898H
7.4L V8 454 CID	1999-2000	Base, LS; High performance	US5038H	5.0L V8 5031cc 307 CID	1969-1972		US898
<b>C3605</b>				5.0L V8 5031cc 307 CID	1969-1972	High performance	US898H
4.7L V8 4738cc 283 CID	1967	Mexican Application	US898	5.3L V8 5358cc 327 CID	1967-1969		US898
4.8L L6 4800cc 292 CID	1967	Mexican Application	US896	5.3L V8 5358cc 327 CID	1967-1969	High performance	US898H
<b>C5500 KODIAK</b>				5.4L V8 327 CID	1968-1969		US898
6.0L V8 366 CID	1990	Without threaded hub	US5084	5.4L V8 327 CID	1968-1969	High performance	US898H
6.0L V8 366 CID	1990-1991	With threaded hub for fan clutch	US5078	5.7L V8 350 CID	1968-1972		US898
<b>C6500 KODIAK</b>				5.7L V8 350 CID	1968-1972	High performance	US898H
6.0L V8 366 CID	1997-1998	With threaded hub for fan clutch	US5078	5.7L V8 350 CID	1976		US1109
7.0L V8 6998cc 427 CID	1997-1998	With threaded hub for fan clutch	US5078	5.7L V8 350 CID	1976	High performance	US1109H
<b>C7500 KODIAK</b>				5.7L V8 350 CID	1977-1979		US1121
6.0L V8 366 CID	1997-1998	With threaded hub for fan clutch	US5078	5.7L V8 350 CID	1977-1979	High performance	US1121H
7.0L V8 6998cc 427 CID	1997-1998	With threaded hub for fan clutch	US5078	5.7L V8 350 CID	1980	Base, Berlinetta, Rally Sport, Z28	US1121
<b>C20905</b>				5.7L V8 350 CID	1980	Base, Berlinetta, Rally Sport, Z28; High performance	US1121H
4.7L V8 4738cc 283 CID	1965-1967	Mexican Application	US898	5.7L V8 350 CID	1981	Berlinetta, Sport, Z28	US1121
4.8L L6 4800cc 292 CID	1965-1967	Mexican Application	US896	5.7L V8 350 CID	1981	Berlinetta, Sport, Z28; High performance	US1121H
<b>CAMARO</b>				5.7L V8 350 CID	1987	Iroc-Z	US1121
2.0L L4 1998cc 122 CID	2016	LT	US8102	5.7L V8 350 CID	1987	Iroc-Z; High performance	US1121H
2.0L L4 1998cc 122 CID	2017	LS, LT	US8102	5.7L V8 350 CID	1988-1990	Iroc-Z	US5049
2.5L L4 2474cc 151 CID	1982-1984	Sport	US1107	5.7L V8 350 CID	1988-1990	Iroc-Z; High performance	US5049H
2.5L L4 2474cc 151 CID	1985-1986	Sport	US5022	5.7L V8 350 CID	1991	Z28	US5049
2.8L V6 173 CID	1982-1984	Berlinetta, Sport	US5006	5.7L V8 350 CID	1991	Z28; High performance	US5049H
2.8L V6 173 CID	1985-1986	Berlinetta, Sport	US5001	5.7L V8 350 CID	1992	Z28, Z28 Heritage Edition	US5049
2.8L V6 173 CID	1987	LT, Sport	US5037	5.7L V8 350 CID	1992	Z28, Z28 Heritage Edition; High performance	US5049H
2.8L V6 173 CID	1988	Base	US5037	5.7L V8 350 CID	1993	Indianapolis 500 Pace Car, Z28	US5068
2.8L V6 173 CID	1989	RS	US5037	5.7L V8 350 CID	1994-1997	Z28	US5068
3.1L V6 189 CID	1990-1991	RS	US5037	5.7L V8 350 CID	1998-2002	Z28, Z28 SS	US5081
3.1L V6 189 CID	1992	RS, RS Heritage Edition	US5037	5.7L V8 5736cc 350 CID	1967-1972		US898
3.4L V6 207 CID	1993-1995	Base	US5070	5.7L V8 5736cc 350 CID	1967-1972	High performance	US898H
3.6L V6 222 CID	2016	LT	US8148	5.7L V8 5737cc 350 CID	1972		US898
3.6L V6 222 CID	2017	LS, LT	US8148	5.7L V8 5737cc 350 CID	1972	High performance	US898H
3.6L V6 3564cc 217 CID	2010-2013	LS, LT	US8932	6.2L V8 6162cc 376 CID	2010-2015	SS	US6689
3.6L V6 3564cc 217 CID	2015	LS, LT	US8932	6.2L V8 6162cc 376 CID	2012-2015	ZL1	US79
3.8L V6 229 CID	1980	Base, Berlinetta, Rally Sport	US1121	6.2L V8 6162cc 376 CID	2016	SS	US8918
3.8L V6 229 CID	1980	Base, Berlinetta, Rally Sport; High performance	US1121H	6.2L V8 6162cc 376 CID	2016	SS; Pump only	US8918

WATER PUMPS

Engine	Years	Application Description	USMW	Engine	Years	Application Description	USMW
<b>CHEVROLET (cont'd.)</b>				<b>CHEVROLET (cont'd.)</b>			
<b>CAMARO (cont'd.)</b>				<b>CAPRICE (cont'd.)</b>			
6.2L V8 6162cc 376 CID	2017	SS, ZL1	<b>US8918</b>	5.0L V8 305 CID	1989-1990	Base, Classic, Classic Brougham, Classic LS Brougham; High performance	<b>US5049H</b>
6.2L V8 6162cc 376 CID	2017	SS, ZL1; Pump only	<b>US8918</b>	5.0L V8 305 CID	1991-1992	Base, Classic, Classic LTZ	<b>US5051</b>
6.5L V8 396 CID	1968		<b>US981</b>	5.0L V8 305 CID	1993	Classic, Classic LS	<b>US5051</b>
6.5L V8 6489cc 396 CID	1967-1969		<b>US981</b>	5.0L V8 307 CID	1968		<b>US898</b>
6.6L V8 402 CID	1970-1972		<b>US981</b>	5.0L V8 307 CID	1968	High performance	<b>US898H</b>
6.6L V8 6588cc 402 CID	1970-1972		<b>US981</b>	5.0L V8 307 CID	1986	Classic, Classic Brougham	<b>US1120</b>
7.0L V8 427 CID	1969		<b>US981</b>	5.0L V8 307 CID	1986	Classic, Classic Brougham; High performance	<b>US1120H</b>
7.0L V8 6998cc 427 CID	1969		<b>US981</b>	5.0L V8 307 CID	1987	Base, Classic	<b>US1120</b>
<b>CAPRICE</b>				5.0L V8 307 CID	1987	Base, Classic; High performance	<b>US1120H</b>
3.6L V6 3564cc 217 CID	2012-2013	PPV	<b>US8932</b>	5.0L V8 307 CID	1988-1990	Classic	<b>US1120</b>
3.6L V6 3564cc 217 CID	2015-2017	PPV	<b>US8932</b>	5.0L V8 307 CID	1988-1990	Classic; High performance	<b>US1120H</b>
3.8L V6 229 CID	1980	Classic, Classic Landau, Classic Sport	<b>US1121</b>	5.0L V8 307 CID	1988-1990	Classic	<b>US1120</b>
3.8L V6 229 CID	1980	Classic, Classic Landau, Classic Sport; High performance	<b>US1121H</b>	5.0L V8 307 CID	1988-1990	Classic; High performance	<b>US1120H</b>
3.8L V6 229 CID	1981	Classic, Classic Estate, Classic Landau	<b>US1121</b>	5.0L V8 5031cc 307 CID	1968-1969	High performance	<b>US898</b>
3.8L V6 229 CID	1981	Classic, Classic Estate, Classic Landau; High performance	<b>US1121H</b>	5.0L V8 5031cc 307 CID	1968-1969	High performance	<b>US898H</b>
3.8L V6 229 CID	1982	Classic, Classic Estate	<b>US1121</b>	5.0L V8 5031cc 307 CID	1971-1972	High performance	<b>US898</b>
3.8L V6 229 CID	1982	Classic, Classic Estate; High performance	<b>US1121H</b>	5.0L V8 5031cc 307 CID	1971-1972	High performance	<b>US898H</b>
3.8L V6 229 CID	1983-1984	Classic	<b>US1121</b>	5.3L V8 5358cc 327 CID	1966-1969		<b>US898</b>
3.8L V6 229 CID	1983-1984	Classic; High performance	<b>US1121H</b>	5.3L V8 5358cc 327 CID	1966-1969	High performance	<b>US898H</b>
3.8L V6 3800cc 231 CID	1980	Classic, Classic Landau, Classic Sport	<b>US1018</b>	5.4L V8 327 CID	1968-1969	High performance	<b>US898</b>
3.8L V6 3800cc 231 CID	1980	Classic, Classic Landau, Classic Sport; High performance	<b>US1018H</b>	5.4L V8 327 CID	1968-1969	High performance	<b>US898H</b>
3.8L V6 3800cc 231 CID	1981	Classic, Classic Estate, Classic Landau	<b>US1018</b>	5.7L V8 350 CID	1969-1972	High performance	<b>US898</b>
3.8L V6 3800cc 231 CID	1981	Classic, Classic Estate, Classic Landau; High performance	<b>US1018H</b>	5.7L V8 350 CID	1969-1972	High performance	<b>US898H</b>
3.8L V6 3800cc 231 CID	1982	Classic, Classic Estate	<b>US1018</b>	5.7L V8 350 CID	1976	High performance	<b>US1109</b>
3.8L V6 3800cc 231 CID	1982	Classic, Classic Estate; High performance	<b>US1018H</b>	5.7L V8 350 CID	1976	High performance	<b>US1109H</b>
3.8L V6 3800cc 231 CID	1983-1984	Classic	<b>US1018</b>	5.7L V8 350 CID	1977-1979	High performance	<b>US1121</b>
3.8L V6 3800cc 231 CID	1983-1984	Classic; High performance	<b>US1018H</b>	5.7L V8 350 CID	1977-1979	High performance	<b>US1121H</b>
4.3L V6 262 CID	1985	Classic	<b>US1121</b>	5.7L V8 350 CID	1980	Classic, Classic Landau, Classic Sport; Exc.Air Cond	<b>US1100</b>
4.3L V6 262 CID	1985	Classic; High performance	<b>US1121H</b>	5.7L V8 350 CID	1980	Classic, Classic Landau, Classic Sport; With air cond.	<b>US1120</b>
4.3L V6 262 CID	1986	Base, Classic, Classic Brougham	<b>US1121</b>	5.7L V8 350 CID	1980	Classic, Classic Landau, Classic Sport; High performance	<b>US1121H</b>
4.3L V6 262 CID	1986	Base, Classic, Classic Brougham; High performance	<b>US1121H</b>	5.7L V8 350 CID	1981	Classic, Classic Estate, Classic Landau; Exc.Air Cond	<b>US1100</b>
4.3L V6 262 CID	1987-1988	Base, Classic, Classic Brougham, Classic LS Brougham	<b>US1121</b>	5.7L V8 350 CID	1981	Classic, Classic Estate, Classic Landau; With air cond.	<b>US1120</b>
4.3L V6 262 CID	1987-1988	Base, Classic, Classic Brougham, Classic LS Brougham; High performance	<b>US1121H</b>	5.7L V8 350 CID	1981	Classic, Classic Estate, Classic Landau; High performance, With air cond.	<b>US1120H</b>
4.3L V6 262 CID	1989-1990	Base, Classic	<b>US5049</b>	5.7L V8 350 CID	1982	Classic, Classic Estate; 5" Cast, Exc.Air Cond	<b>US1100</b>
4.3L V6 262 CID	1989-1990	Base, Classic; High performance	<b>US5049H</b>	5.7L V8 350 CID	1982	Classic, Classic Estate; Exc.5" Cast, Exc.Air Cond	<b>US1120</b>
4.3L V6 262 CID	1992	Base	<b>US5049</b>	5.7L V8 350 CID	1982	Classic, Classic Estate; With air cond.	<b>US1120</b>
4.3L V6 262 CID	1992	Base; High performance	<b>US5049H</b>	5.7L V8 350 CID	1982	Classic, Classic Estate; Exc.5" Cast, Exc.Air Cond, High performance	<b>US1120H</b>
4.3L V6 262 CID	1993	Classic	<b>US5049</b>	5.7L V8 350 CID	1982	Classic, Classic Estate; High performance, With air cond.	<b>US1120H</b>
4.3L V6 262 CID	1993	Classic; High performance	<b>US5049H</b>	5.7L V8 350 CID	1983-1985	Classic; 5" Cast, Exc.Air Cond	<b>US1100</b>
4.3L V8 265 CID	1994	Classic, Classic LS	<b>US5069</b>	5.7L V8 350 CID	1983-1985	Classic; Exc.5" Cast, Exc.Air Cond	<b>US1120</b>
4.3L V8 265 CID	1995-1996	Classic	<b>US5069</b>	5.7L V8 350 CID	1983-1985	Classic; With air cond.	<b>US1120</b>
4.4L V8 267 CID	1980	Classic, Classic Landau, Classic Sport	<b>US1121</b>	5.7L V8 350 CID	1983-1985	Classic; Exc.5" Cast, Exc.Air Cond, High performance	<b>US1120H</b>
4.4L V8 267 CID	1980	Classic, Classic Landau, Classic Sport; High performance	<b>US1121H</b>	5.7L V8 350 CID	1983-1985	Classic; High performance, With air cond.	<b>US1120H</b>
4.4L V8 267 CID	1981	Classic, Classic Estate, Classic Landau	<b>US1121</b>	5.7L V8 350 CID	1989-1990	Base	<b>US5049</b>
4.4L V8 267 CID	1981	Classic, Classic Estate, Classic Landau; High performance	<b>US1121H</b>	5.7L V8 350 CID	1989-1990	Base; High performance	<b>US5049H</b>
4.4L V8 267 CID	1982	Classic, Classic Estate	<b>US1121</b>	5.7L V8 350 CID	1991-1992	Base, Classic, Classic LTZ	<b>US5051</b>
4.4L V8 267 CID	1982	Classic, Classic Estate; High performance	<b>US1121H</b>	5.7L V8 350 CID	1993	Classic LTZ	<b>US5051</b>
4.6L V8 4638cc 283 CID	1966-1967		<b>US898</b>	5.7L V8 350 CID	1994	Classic, Classic LS	<b>US5069</b>
4.6L V8 4638cc 283 CID	1966-1967	High performance	<b>US898H</b>	5.7L V8 350 CID	1995-1996	Classic	<b>US5069</b>
5.0L V8 305 CID	1977-1979		<b>US1121</b>	5.7L V8 5700cc 350 CID	1981	Mexican Application	<b>US1121</b>
5.0L V8 305 CID	1977-1979	High performance	<b>US1121H</b>	5.7L V8 5736cc 350 CID	1969-1972		<b>US898</b>
5.0L V8 305 CID	1980	Classic, Classic Landau, Classic Sport	<b>US1121</b>	5.7L V8 5736cc 350 CID	1969-1972	High performance	<b>US898H</b>
5.0L V8 305 CID	1980	Classic, Classic Landau, Classic Sport; High performance	<b>US1121H</b>	5.7L V8 5736cc 350 CID	1982	Mexican Application	<b>US1121</b>
5.0L V8 305 CID	1981	Classic, Classic Estate, Classic Landau	<b>US1121</b>	6.0L V8 5967cc 364 CID	2011-2017	PPV	<b>US79</b>
5.0L V8 305 CID	1981	Classic, Classic Estate, Classic Landau; High performance	<b>US1121H</b>	6.5L V8 396 CID	1968-1969		<b>US981</b>
5.0L V8 305 CID	1982	Classic, Classic Estate	<b>US1121</b>	6.5L V8 6489cc 396 CID	1966-1969		<b>US981</b>
5.0L V8 305 CID	1982	Classic, Classic Estate; High performance	<b>US1121H</b>	6.6L V8 400 CID	1970-1972		<b>US981</b>
5.0L V8 305 CID	1983-1985	Classic	<b>US1121</b>	6.6L V8 400 CID	1975-1976		<b>US1109</b>
5.0L V8 305 CID	1983-1985	Classic; High performance	<b>US1121H</b>	6.6L V8 400 CID	1975-1976	High performance	<b>US1109H</b>
5.0L V8 305 CID	1986	Base, Classic, Classic Brougham	<b>US1121</b>	6.6L V8 402 CID	1971-1972		<b>US981</b>
5.0L V8 305 CID	1986	Base, Classic, Classic Brougham; High performance	<b>US1121H</b>	6.6L V8 6555cc 400 CID	1970-1972		<b>US981</b>
5.0L V8 305 CID	1987-1988	Base, Classic, Classic Brougham, Classic LS Brougham	<b>US1121</b>	6.6L V8 6556cc 400 CID	1970-1972		<b>US981</b>
5.0L V8 305 CID	1987-1988	Base, Classic, Classic Brougham, Classic LS Brougham; High performance	<b>US1121H</b>	6.6L V8 6588cc 402 CID	1970-1972		<b>US981</b>
5.0L V8 305 CID	1989-1990	Base, Classic, Classic Brougham, Classic LS Brougham	<b>US5049</b>	7.0L V8 427 CID	1968-1969		<b>US981</b>
				<b>CAPTIVA SPORT</b>			
				2.4L L4 2384cc 145 CID	2012	LS	<b>US5092</b>
				2.4L L4 2384cc 145 CID	2013-2015	LS, LT, LTZ	<b>US5092</b>
				2.4L L4 2409cc 147 CID	2010-2015	Mexican Application	<b>US5092</b>
				3.0L V6 182 CID	2012	LT, LTZ	<b>US8932</b>

Engine	Years	Application Description	USMW	Engine	Years	Application Description	USMW
<b>CHEVROLET (cont'd.)</b>				<b>CHEVROLET (cont'd.)</b>			
<b>CAPTIVIA SPORT (cont'd.)</b>				<b>CHEVELLE (cont'd.)</b>			
3.0L V6 3000cc 183 CID	2011-2012	Mexican Application	US8932	4.8L L6 4800cc 292 CID	1967-1970	Mexican Application	US896
3.6L V6 3564cc 217 CID	2008-2009	Mexican Application	US8932	4.8L L6 4800cc 292 CID	1973	Mexican Application	US896
<b>CAVALIER</b>				5.0L V8 307 CID	1968-1972		US898
1.8L L4 112 CID	1982	Base, Cadet, CL	US5007	5.0L V8 307 CID	1968-1972	High performance	US898H
2.0L L4 122 CID	1983	Base, CL, CS	US5007	5.0L V8 5031cc 307 CID	1968-1972		US898
2.0L L4 122 CID	1984	Base, CL, CS, Olympic, Type-10	US5007	5.0L V8 5031cc 307 CID	1968-1972	High performance	US898H
2.0L L4 122 CID	1985	Base, CL, CS, Type-10	US5007	5.3L V8 5358cc 327 CID	1964-1968		US898
2.0L L4 122 CID	1986	Base, CL, CS, RS	US5007	5.3L V8 5358cc 327 CID	1964-1968	High performance	US898H
2.0L L4 122 CID	1987	Base, CS, RS	US5032	5.4L V8 327 CID	1965		US898
2.0L L4 122 CID	1988-1989	Base, RS, VL	US5032	5.4L V8 327 CID	1965	High performance	US898H
2.2L L4 134 CID	1990	Base, RS, VL	US5032	5.4L V8 327 CID	1967-1968		US898
2.2L L4 134 CID	1991	RS, VL	US5032	5.4L V8 327 CID	1967-1968	High performance	US898H
2.2L L4 2190cc 134 CID	1992-1994	RS, VL	US5032	5.7L V8 350 CID	1969-1972		US898
2.2L L4 2190cc 134 CID	1995-1996	Base, LS	US5032	5.7L V8 350 CID	1969-1972	High performance	US898H
2.2L L4 2190cc 134 CID	1997	Base; (4)	US5032	5.7L V8 5736cc 350 CID	1968-1972		US898
2.2L L4 2190cc 134 CID	1997	LS, RS	US5032	5.7L V8 5736cc 350 CID	1968-1972	High performance	US898H
2.2L L4 2190cc 134 CID	1998-1999	Base, LS, RS	US5032	6.5L V8 396 CID	1966-1970		US981
2.2L L4 2190cc 134 CID	2000-2001	Base, LS	US5032	6.5L V8 6489cc 396 CID	1966-1969		US981
2.2L L4 2190cc 134 CID	2002	Base, LS, LS Sport; (4)	US5032	6.6L V8 400 CID	1970-1971		US981
2.2L L4 2198cc 134 CID	2002	Base, LS, LS Sport; (F)	US5092	6.6L V8 402 CID	1970		US981
2.2L L4 2198cc 134 CID	2003-2005	Base, LS, LS Sport	US5092	6.6L V8 402 CID	1972		US981
2.3L L4 138 CID	1995	LS, Z24	US5043	6.6L V8 6555cc 400 CID	1970-1972		US981
2.4L L4 2392cc 146 CID	1996-2001	LS, Z24	US5076	6.6L V8 6556cc 400 CID	1970-1971		US981
2.4L L4 2392cc 146 CID	2002	LS, LS Sport, Z24	US5076	6.6L V8 6588cc 402 CID	1970-1972		US981
2.8L V6 173 CID	1985	Base, CL, CS, Type-10	US5020	<b>CHEVETTE</b>			
2.8L V6 173 CID	1986	RS, Z24	US5020	1.6L L4 98 CID	1976-1979		US5004
2.8L V6 173 CID	1987	Base, CS, RS, Z24	US5033	1.6L L4 98 CID	1980-1982	Base, Scooter	US5004
2.8L V6 173 CID	1988	Base, Z24	US5033	1.6L L4 98 CID	1983	Base, S, Scooter	US5004
2.8L V6 173 CID	1989	Base, RS, Z24	US5033	1.6L L4 98 CID	1984-1985	Base, CS	US5004
2.8L V6 2800cc 173 CID	1990-1994	Mexican Application	US5033	1.6L L4 98 CID	1986-1987	CS	US5004
3.1L V6 189 CID	1990	Base, RS, Z24	US5033	1.8L L4 1819cc 110 CID	1985	Base, CS	US5027
3.1L V6 189 CID	1991-1994	RS, Z24	US5033	1.8L L4 1819cc 110 CID	1986	CS	US5027
<b>CELEBRITY</b>				<b>CHEVY</b>			
2.5L L4 2474cc 151 CID	1982	Base, CL, CS	US5000	1.6L L4 1598cc 98 CID	2010-2012	Mexican Application	US5057
2.5L L4 2474cc 151 CID	1982	Base, CL, CS; Includes pulley	US5000P	1.6L L4 1600cc 98 CID	1999-2003	Mexican Application	US5057
2.5L L4 2474cc 151 CID	1983	Base, CL	US5000	1.6L L4 1606cc 98 CID	2004-2009	Mexican Application	US5057
2.5L L4 2474cc 151 CID	1983	Base, CL; Includes pulley	US5000P	<b>CHEVY II</b>			
2.5L L4 2474cc 151 CID	1984	Base, Eurosport	US5000	4.6L V8 283 CID	1964-1966		US898
2.5L L4 2474cc 151 CID	1984	Base, Eurosport; Includes pulley	US5000P	4.6L V8 283 CID	1964-1966	High performance	US898H
2.5L L4 2474cc 151 CID	1985	Base, Classic, Estate, Eurosport	US5000	4.6L V8 4638cc 283 CID	1963-1967		US898
2.5L L4 2474cc 151 CID	1985	Base, Classic, Estate, Eurosport; Includes pulley	US5000P	4.6L V8 4638cc 283 CID	1963-1967	High performance	US898H
2.5L L4 2474cc 151 CID	1986	Base, Estate, Eurosport	US5000	5.0L V8 307 CID	1968		US898
2.5L L4 2474cc 151 CID	1986	Base, Estate, Eurosport; Includes pulley	US5000P	5.0L V8 307 CID	1968	High performance	US898H
2.5L L4 2474cc 151 CID	1987	Base, Estate, Eurosport	US5041	5.0L V8 307 CID	1968		US898
2.5L L4 2474cc 151 CID	1988	Base, Eurosport	US5041	5.0L V8 5031cc 307 CID	1968	High performance	US898H
2.5L L4 2474cc 151 CID	1989	Base, CL, Eurosport	US5041	5.0L V8 5031cc 307 CID	1968		US898
2.5L L4 2474cc 151 CID	1990	Base, Eurosport	US5041	5.3L V8 5358cc 327 CID	1965-1968		US898
2.8L V6 173 CID	1982	Base, CL, CS	US5001	5.3L V8 5358cc 327 CID	1965-1968	High performance	US898H
2.8L V6 173 CID	1983	Base, CL	US5001	5.4L V8 327 CID	1965-1966		US898
2.8L V6 173 CID	1984	Base, Eurosport	US5001	5.4L V8 327 CID	1965-1966	High performance	US898H
2.8L V6 173 CID	1985	Base, Classic, Estate, Eurosport	US5001	5.4L V8 327 CID	1968		US898
2.8L V6 173 CID	1986	Base, Estate, Eurosport	US5001	5.4L V8 327 CID	1968	High performance	US898H
2.8L V6 173 CID	1987	Base, Estate, Eurosport	US5033	5.7L V8 350 CID	1968		US898
2.8L V6 173 CID	1988	Base, Eurosport	US5033	5.7L V8 350 CID	1968	High performance	US898H
2.8L V6 173 CID	1989	Base, CL, Eurosport	US5033	5.7L V8 5736cc 350 CID	1968		US898
2.8L V6 2800cc 173 CID	1990	Mexican Application	US5033	5.7L V8 5736cc 350 CID	1968	High performance	US898H
2.8L V6 2835cc 173 CID	1982-1984	Mexican Application	US5033	6.5L V8 396 CID	1968		US981
3.1L V6 189 CID	1990	Base, Eurosport	US5033	6.5L V8 6489cc 396 CID	1968		US981
4.3L V6 260 CID	1982	Base, CL, CS; W/O Pulley	US5014	<b>CHEYENNE</b>			
4.3L V6 260 CID	1982	Base, CL, CS; Includes pulley	US5014P	5.3L V8 5300cc 323 CID	2007-2010	Mexican Application	US6009
4.3L V6 260 CID	1983	Base, CL; W/O Pulley	US5014	<b>CHEYENNE 2500</b>			
4.3L V6 260 CID	1983	Base, CL; Includes pulley	US5014P	5.3L V8 5300cc 323 CID	2011	Mexican Application	US6009
4.3L V6 260 CID	1984	Base, Eurosport; W/O Pulley	US5014	5.3L V8 5328cc 325 CID	2012-2015	Mexican Application	US6009
4.3L V6 260 CID	1984	Base, Eurosport; Includes pulley	US5014P	<b>CITATION</b>			
4.3L V6 260 CID	1985	Base, Classic, Estate, Eurosport; W/O Pulley	US5014	2.5L L4 2474cc 151 CID	1980	Base, Club, Custom, X-11	US5000
4.3L V6 260 CID	1985	Base, Classic, Estate, Eurosport; Includes pulley	US5014P	2.5L L4 2474cc 151 CID	1980	Base, Club, Custom, X-11; Includes pulley	US5000P
<b>CENTURY</b>				2.5L L4 2474cc 151 CID	1981-1983	Base, X-11	US5000
2.2L L4 2196cc 134 CID	1995	Mexican Application	US5033	2.5L L4 2474cc 151 CID	1981-1983	Base, X-11; Includes pulley	US5000P
2.8L V6 2800cc 173 CID	1983-1986	Mexican Application	US5033	2.8L V6 173 CID	1980	Base, Club, Custom, X-11	US5001
2.8L V6 2800cc 173 CID	1990	Mexican Application	US5033	2.8L V6 173 CID	1981-1983	Base, X-11	US5001
3.1L V6 3130cc 191 CID	1989-1997	Mexican Application	US5033	2.8L V6 2800cc 173 CID	1984-1988	Mexican Application	US5001
<b>CHEVELLE</b>				<b>CITATION II</b>			
3.2L L6 194 CID	1966	With A/C	US927	2.5L L4 2474cc 151 CID	1984-1985	Base, X-11	US5000
3.8L L6 230 CID	1967	With A/C	US927	2.5L L4 2474cc 151 CID	1984-1985	Base, X-11; Includes pulley	US5000P
3.8L L6 3800cc 230 CID	1970	Mexican Application	US895	2.8L V6 173 CID	1984-1985	Base, X-11	US5001
4.1L L6 250 CID	1967	With A/C	US927	<b>CITY EXPRESS</b>			
4.1L L6 4100cc 250 CID	1964-1966	Mexican Application	US895	2.0L L4 1997cc	2015-2017	LS, LT	US6218
4.6L V8 283 CID	1965-1967		US898	<b>CLASSIC</b>			
4.6L V8 283 CID	1965-1967	High performance	US898H	2.2L L4 2198cc 134 CID	2004	Base, LS	US5092
4.6L V8 4638cc 283 CID	1964-1967		US898	2.2L L4 2198cc 134 CID	2005	Base	US5092
4.6L V8 4638cc 283 CID	1964-1967	High performance	US898H				

WATER PUMPS



Engine	Years	Application Description	USMW	Engine	Years	Application Description	USMW
<b>CHEVROLET (cont'd.)</b>				<b>CHEVROLET (cont'd.)</b>			
<b>COBALT</b>				<b>CORVETTE (cont'd.)</b>			
2.0L L4 122 CID	2005-2007	SS	<b>US5092</b>	5.7L V8 350 CID	1990-1995	ZR-1	<b>US5056</b>
2.0L L4 1998cc 122 CID	2008-2010	SS	<b>US5092</b>	5.7L V8 350 CID	1992	Base	<b>US5063</b>
2.2L L4 2198cc 134 CID	2005	Base, LS, LT	<b>US5092</b>	5.7L V8 350 CID	1993	40th Anniversary Edition, Base	<b>US5066</b>
2.2L L4 2198cc 134 CID	2006-2007	LS, LT, LTZ	<b>US5092</b>	5.7L V8 350 CID	1994	Base	<b>US5066</b>
2.2L L4 2198cc 134 CID	2008-2009	LS, LT	<b>US5092</b>	5.7L V8 350 CID	1995	Base, Indianapolis 500 Pace Car	<b>US5066</b>
2.2L L4 2198cc 134 CID	2010	Base, LS, LT	<b>US5092</b>	5.7L V8 350 CID	1996	Base, Collector's Edition, Grand Sport	<b>US5066</b>
2.4L L4 2384cc 145 CID	2006-2007	SS	<b>US5092</b>	5.7L V8 350 CID	1997	Base	<b>US5081</b>
2.4L L4 2384cc 145 CID	2008	Sport	<b>US5092</b>	5.7L V8 350 CID	1998	Base, Indianapolis 500 Pace Car	<b>US5081</b>
<b>COLORADO</b>				5.7L V8 350 CID	1999-2000	Base	<b>US5081</b>
2.5L L4 2457cc 153 CID	2015	Base, LT, WT, Z71; Pump only	<b>US8102</b>	5.7L V8 350 CID	2001-2002	Base, Z06	<b>US5081</b>
2.5L L4 2457cc 153 CID	2015-2017	Base, LT, WT, Z71	<b>US8102</b>	5.7L V8 350 CID	2003	50th Anniversary Edition, 50th Anniversary Edition Pace Car, Base, Z06	<b>US5081</b>
2.8L L4 171 CID	2016	LT, WT, Z71	<b>US8154</b>	5.7L V8 350 CID	2004	Base, Z06	<b>US5081</b>
2.8L L4 171 CID	2017	LT, WT, Z71, ZR2	<b>US8154</b>	5.7L V8 5736cc 350 CID	1969-1972	High performance	<b>US898H</b>
2.8L L4 2770cc 169 CID	2004	Base, LS, Sport, Sport LS, Z71, Z71 LS, Z85, Z85 LS	<b>US5097</b>	5.7L V8 5736cc 350 CID	1969-1972	High performance	<b>US898H</b>
2.8L L4 2770cc 169 CID	2005	Sport, Sport LS, Z71, Z71 LS, Z85, Z85 LS	<b>US5097</b>	5.7L V8 5737cc 350 CID	1972	High performance	<b>US898H</b>
2.8L L4 2770cc 169 CID	2006	LS, LT, WT	<b>US5097</b>	5.7L V8 5737cc 350 CID	1972	High performance	<b>US898H</b>
2.9L L4 2921cc 178 CID	2007	LS, LT	<b>US5097</b>	6.0L V8 364 CID	2005	Base	<b>US65N</b>
2.9L L4 2921cc 178 CID	2008	LS, LT, WT	<b>US5097</b>	6.0L V8 364 CID	2005	Base; Includes thermostat and thermostat housing	<b>US65N-T</b>
2.9L L4 2921cc 178 CID	2009-2012	LT, WT	<b>US5097</b>	6.0L V8 5967cc 364 CID	2006-2007	Base	<b>US65N</b>
3.5L L5 3460cc 211 CID	2004	Base, LS, Sport, Sport LS, Z71, Z71 LS, Z85, Z85 LS	<b>US5097</b>	6.0L V8 5967cc 364 CID	2006-2007	Base; Includes thermostat and thermostat housing	<b>US65N-T</b>
3.5L L5 3460cc 211 CID	2005	Sport, Sport LS, Z71, Z71 LS, Z85, Z85 LS	<b>US5097</b>	6.2L V8 6162cc 376 CID	2008	Base	<b>US65N</b>
3.5L L5 3460cc 211 CID	2006	LT, WT	<b>US5097</b>	6.2L V8 6162cc 376 CID	2008	Base; Includes thermostat and thermostat housing	<b>US65N-T</b>
3.6L V6 222 CID	2017	LT, WT, Z71, ZR2	<b>US8153</b>	6.2L V8 6162cc 376 CID	2009	Base	<b>US79</b>
3.6L V6 3564cc 217 CID	2014-2015	Mexican Application	<b>US8932</b>	6.2L V8 6162cc 376 CID	2009-2013	ZR1; Pump only	<b>US8142</b>
3.6L V6 3564cc 217 CID	2015-2016	LT, WT, Z71	<b>US8932</b>	6.2L V8 6162cc 376 CID	2009-2013	ZR1; Includes Thermostat and Thermostat Housing	<b>US8142-T</b>
3.6L V6 3600cc 217 CID	2013	Mexican Application	<b>US8932</b>	6.2L V8 6162cc 376 CID	2010-2013	Base, Grand Sport	<b>US79</b>
3.7L L5 3654cc 223 CID	2007-2008	LS, LT, WT	<b>US5097</b>	6.2L V8 6162cc 376 CID	2014	Stingray; Pump only	<b>US8123</b>
3.7L L5 3654cc 223 CID	2009-2012	LT, WT	<b>US5097</b>	6.2L V8 6162cc 376 CID	2015-2016	Stingray, Z06	<b>US8123</b>
5.3L V8 5328cc 325 CID	2009-2012	LT	<b>US6009</b>	6.2L V8 6162cc 376 CID	2015-2016	Stingray, Z06; Pump only	<b>US8123</b>
5.3L V8 5328cc 325 CID	2009-2012	LT; Includes thermostat and thermostat housing	<b>US6009-T</b>	6.2L V8 6162cc 376 CID	2017	Grand Sport, Stingray, Z06	<b>US8123</b>
<b>CORSA</b>				6.2L V8 6162cc 376 CID	2017	Grand Sport, Stingray, Z06; Pump only	<b>US8123</b>
1.4L L4 1389cc 85 CID	2002	Mexican Application	<b>US5057</b>	7.0L V8 427 CID	1968-1969		<b>US981</b>
1.4L L4 1389cc 85 CID	2003	Mexican Application	<b>US8933</b>	7.0L V8 427 CID	1968-1969	Standard	<b>US5019</b>
1.8L L4 1796cc 110 CID	2003-2008		<b>US8938</b>	7.0L V8 427 CID	1968-1969	High performance	<b>US5019H</b>
<b>CORSICA</b>				7.0L V8 427 CID	1966-1969		<b>US981</b>
2.0L L4 122 CID	1987-1988	Base, LT	<b>US5032</b>	7.0L V8 6998cc 427 CID	1966-1969	Standard	<b>US5019</b>
2.0L L4 122 CID	1989	Base	<b>US5032</b>	7.0L V8 6998cc 427 CID	1966-1969	High performance	<b>US5019H</b>
2.2L L4 134 CID	1990-1991	LT	<b>US5032</b>	7.0L V8 7011cc 427 CID	2006-2007	Z06	<b>US65N</b>
2.2L L4 2190cc 134 CID	1992	LT, LTZ	<b>US5032</b>	7.0L V8 7011cc 427 CID	2006-2007	Z06; Includes thermostat and thermostat housing	<b>US65N-T</b>
2.2L L4 2190cc 134 CID	1993	LT	<b>US5032</b>	7.0L V8 7011cc 427 CID	2008	427 Limited Edition Z06, Z06	<b>US65N</b>
2.2L L4 2190cc 134 CID	1994-1996	Base	<b>US5032</b>	7.0L V8 7011cc 427 CID	2008	427 Limited Edition Z06, Z06; Includes thermostat and thermostat housing	<b>US65N-T</b>
2.8L V6 173 CID	1987-1988	Base, LT	<b>US5033</b>	7.0L V8 7011cc 427 CID	2009-2010	Z06	<b>US79</b>
2.8L V6 173 CID	1989	Base, LTZ	<b>US5033</b>	7.0L V8 7011cc 427 CID	2011	Z06, Z06 Carbon	<b>US79</b>
3.1L V6 189 CID	1990	LT, LTZ	<b>US5033</b>	7.0L V8 7011cc 427 CID	2012	Z06	<b>US79</b>
3.1L V6 189 CID	1991	LT	<b>US5033</b>	7.0L V8 7011cc 427 CID	2013	427, Z06	<b>US79</b>
3.1L V6 189 CID	1992	LT, LTZ	<b>US5033</b>	<b>CRUZE</b>			
3.1L V6 189 CID	1993	LT	<b>US5033</b>	1.4L L4 1364cc 83 CID	2011-2015	Eco, LT, LTZ	<b>US6662</b>
3.1L V6 189 CID	1994-1996	Base	<b>US5033</b>	1.4L L4 1399cc 85 CID	2016-2017	L, LS, LT, Premier	<b>US8147</b>
<b>CORVETTE</b>				1.4L L4 1399cc 85 CID	2016-2017	L, LS, LT, Premier; Pump only	<b>US8147</b>
4.3L V8 4343cc 265 CID	1955-1956		<b>US898</b>	1.8L L4 1796cc 110 CID	2010-2016	Mexican Application	<b>US6184</b>
4.3L V8 4343cc 265 CID	1955-1956	High performance	<b>US898H</b>	1.8L L4 1796cc 110 CID	2011-2014	LS	<b>US6184</b>
4.6L V8 4638cc 283 CID	1957-1961		<b>US898</b>	1.8L L4 1796cc 110 CID	2012	Mexican Application	<b>US6046</b>
4.6L V8 4638cc 283 CID	1957-1961	High performance	<b>US898H</b>	1.8L L4 1796cc 110 CID	2015	L, LS	<b>US6184</b>
5.0L V8 305 CID	1980	Base	<b>US984</b>	2.0L L4 1956cc 119 CID	2014-2015	Diesel	<b>US8159</b>
5.0L V8 305 CID	1980	Base; High performance	<b>US984H</b>	<b>CRUZE LIMITED</b>			
5.3L V8 5358cc 327 CID	1962-1968		<b>US898</b>	1.4L L4 1364cc 83 CID	2016	Eco, LT, LTZ	<b>US6662</b>
5.3L V8 5358cc 327 CID	1962-1968	High performance	<b>US898H</b>	1.8L L4 1796cc 110 CID	2016	L, LS	<b>US6184</b>
5.4L V8 327 CID	1968		<b>US898</b>	<b>CS1073</b>			
5.4L V8 327 CID	1968	High performance	<b>US898H</b>	4.1L L6 4100cc 250 CID	1966-1974	Mexican Application	<b>US895</b>
5.7L V8 350 CID	1969-1972		<b>US898</b>	4.1L L6 4100cc 250 CID	1975-1977	Mexican Application	<b>US1110</b>
5.7L V8 350 CID	1969-1972	High performance	<b>US898H</b>	4.1L L6 4100cc 250 CID	1978	Mexican Application	<b>US1107</b>
5.7L V8 350 CID	1976-1979		<b>US984</b>	4.7L V8 4738cc 283 CID	1964-1967	Mexican Application	<b>US898</b>
5.7L V8 350 CID	1976-1979	High performance	<b>US984H</b>	4.8L L6 4800cc 292 CID	1964-1974	Mexican Application	<b>US896</b>
5.7L V8 350 CID	1980-1981	Base	<b>US984</b>	4.8L L6 4800cc 292 CID	1975-1977	Mexican Application	<b>US1137</b>
5.7L V8 350 CID	1980-1981	Base; High performance	<b>US984H</b>	4.8L L6 4800cc 292 CID	1978	Mexican Application	<b>US5030</b>
5.7L V8 350 CID	1982	Base, Collector's Edition	<b>US984</b>	5.4L V8 5400cc 327 CID	1964-1969	Mexican Application	<b>US898</b>
5.7L V8 350 CID	1982	Base, Collector's Edition; High performance	<b>US984H</b>	<b>CS31003</b>			
5.7L V8 350 CID	1984-1985	Base	<b>US5016</b>	4.7L V8 4738cc 283 CID	1964-1967	Mexican Application	<b>US898</b>
5.7L V8 350 CID	1984-1985	Base; High performance	<b>US5016H</b>	4.8L L6 4800cc 292 CID	1965-1974	Mexican Application	<b>US896</b>
5.7L V8 350 CID	1986	Base, Indianapolis 500 Pace Car	<b>US5016</b>	4.8L L6 4800cc 292 CID	1975-1977	Mexican Application	<b>US1137</b>
5.7L V8 350 CID	1986	Base, Indianapolis 500 Pace Car; High performance	<b>US5016H</b>	4.8L L6 4800cc 292 CID	1978	Mexican Application	<b>US5030</b>
5.7L V8 350 CID	1987	Base	<b>US5016</b>	5.4L V8 5400cc 327 CID	1964-1969	Mexican Application	<b>US898</b>
5.7L V8 350 CID	1987	Base; High performance	<b>US5016H</b>	<b>CUTLASS</b>			
5.7L V8 350 CID	1988	35th Anniversary Edition, Base	<b>US5016</b>	2.2L L4 2196cc 134 CID	1994-1996	Mexican Application	<b>US5033</b>
5.7L V8 350 CID	1988	35th Anniversary Edition, Base; High performance	<b>US5016H</b>				
5.7L V8 350 CID	1989-1991	Base	<b>US5016</b>				
5.7L V8 350 CID	1989-1991	Base; High performance	<b>US5016H</b>				



Engine	Years	Application Description	USMW	Engine	Years	Application Description	USMW
<b>CHEVROLET (cont'd.)</b>				<b>CHEVROLET (cont'd.)</b>			
<b>CUTLASS (cont'd.)</b>				<b>EL CAMINO (cont'd.)</b>			
2.8L V6 2835cc 173 CID	1986-1989	Mexican Application	US5033	5.7L V8 350 CID	1977-1979	High performance	US1121H
3.1L V6 3130cc 191 CID	1986-1997	Mexican Application	US5033	5.7L V8 350 CID	1983-1984	Base, Conquista, SS	US1120
<b>DEL RAY</b>				5.7L V8 350 CID	1983-1984	Base, Conquista, SS; High performance	US1120H
4.3L V8 4343cc 265 CID	1957		US898	5.7L V8 5704cc 348 CID	1959-1960		US898
4.3L V8 4343cc 265 CID	1957	High performance	US898H	5.7L V8 5704cc 348 CID	1959-1960	High performance	US898H
4.6L V8 4638cc 283 CID	1957-1958		US898	5.7L V8 5736cc 350 CID	1968-1972		US898
4.6L V8 4638cc 283 CID	1957-1958	High performance	US898H	5.7L V8 5736cc 350 CID	1968-1972	High performance	US898H
5.7L V8 5704cc 348 CID	1958		US127	6.5L V8 396 CID	1968-1970		US981
5.7L V8 5704cc 348 CID	1958		US898	6.5L V8 6489cc 396 CID	1966-1969		US981
5.7L V8 5704cc 348 CID	1958	High performance	US898H	6.6L V8 400 CID	1970		US981
<b>EL CAMINO</b>				6.6L V8 400 CID	1975-1976		US1109
3.2L L6 3180cc 194 CID	1966	With A/C	US927	6.6L V8 400 CID	1975-1976	High performance	US1109H
3.3L V6 200 CID	1978-1979		US1121	6.6L V8 402 CID	1971-1972		US981
3.3L V6 200 CID	1978-1979	High performance	US1121H	6.6L V8 6555cc 400 CID	1970-1972		US981
3.8L L6 3769cc 230 CID	1966-1967	With A/C	US927	6.6L V8 6588cc 402 CID	1970-1972		US981
3.8L V6 229 CID	1980	Base, Royal Knight	US1121	<b>EQUINOX</b>			
3.8L V6 229 CID	1980	Base, Royal Knight; High performance	US1121H	2.4L L4 2384cc 145 CID	2010-2014	LS, LT, LTZ	US5092
3.8L V6 229 CID	1981	Base, Conquista, Royal Knight	US1121	2.4L L4 2384cc 145 CID	2015-2016	L, LS, LT, LTZ	US5092
3.8L V6 229 CID	1981	Base, Conquista, Royal Knight; High performance	US1121H	2.4L L4 2384cc 145 CID	2017	L, LS, LT, Premier	US5092
3.8L V6 229 CID	1982	Base, Conquista	US1121	3.0L V6 182 CID	2010-2012	LT, LTZ	US8932
3.8L V6 229 CID	1982	Base, Conquista; High performance	US1121H	3.4L V6 207 CID	2005-2007	LS, LT	US6145
3.8L V6 229 CID	1983	Conquista, SS	US1121	3.4L V6 207 CID	2008-2009	LS, LT, LTZ	US6145
3.8L V6 229 CID	1983	Conquista, SS; High performance	US1121H	3.6L V6 3564cc 217 CID	2008-2009	Sport	US8932
3.8L V6 229 CID	1984	Base, Conquista, SS	US1121	3.6L V6 3564cc 217 CID	2013	LT, LTZ	US8932
3.8L V6 229 CID	1984	Base, Conquista, SS; High performance	US1121H	3.6L V6 3564cc 217 CID	2015-2016	LT, LTZ	US8932
3.8L V6 231 CID	1979		US1018	3.6L V6 3564cc 217 CID	2017	LT, Premier	US8932
3.8L V6 231 CID	1979	High performance	US1018H	<b>EUROSPORT</b>			
3.8L V6 3800cc 231 CID	1978-1979		US1018	3.1L V6 3135cc 191 CID	1991-1996	Mexican Application	US5033
3.8L V6 3800cc 231 CID	1978-1979	High performance	US1018H	<b>EXPRESS</b>			
3.8L V6 3800cc 231 CID	1980	Base, Royal Knight, SS	US1018	4.3L V6 4300cc 262 CID	2010-2013	Mexican Application	US5077
3.8L V6 3800cc 231 CID	1980	Base, Royal Knight, SS; High performance	US1018H	5.3L V8 5300cc 323 CID	2008	Mexican Application	US6009
3.8L V6 3800cc 231 CID	1981	Base, Conquista, Royal Knight, SS	US1018	5.3L V8 5300cc 323 CID	2010-2011	Mexican Application	US6009
3.8L V6 3800cc 231 CID	1981	Base, Conquista, Royal Knight, SS; High performance	US1018H	5.3L V8 5328cc 325 CID	2012-2013	Mexican Application	US6009
3.8L V6 3800cc 231 CID	1982-1984	Base, Conquista, SS	US1018	6.0L V8 5967cc 364 CID	2010-2013	Mexican Application	US6009
3.8L V6 3800cc 231 CID	1982-1984	Base, Conquista, SS; High performance	US1018H	<b>EXPRESS 1500</b>			
4.1L L6 250 CID	1975-1977		US1107	4.3L V6 262 CID	1996-2000	Base, LS	US5077
4.1L L6 4098cc 250 CID	1967	With A/C	US927	4.3L V6 262 CID	1996-2005	Base, LS; High performance	US5077H
4.3L V6 262 CID	1985-1986	Base, Conquista, SS	US1121	4.3L V6 262 CID	2001-2002	Base, LS, LT	US5077
4.3L V6 262 CID	1985-1986	Base, Conquista, SS; High performance	US1121H	4.3L V6 262 CID	2003-2005	Base, LS	US5077
4.3L V6 262 CID	1987	Base, SS	US1121	4.3L V6 262 CID	2006	Base, LS, LT	US5077
4.3L V6 262 CID	1987	Base, SS; High performance	US1121H	4.3L V6 262 CID	2006	Base, LS, LT; High performance	US5077H
4.4L V8 267 CID	1980	Base, Royal Knight, SS	US1121	4.3L V6 262 CID	2007-2011	Base; High performance	US5077H
4.4L V8 267 CID	1980	Base, Royal Knight, SS; High performance	US1121H	4.3L V6 262 CID	2007-2012	Base	US5077
4.4L V8 267 CID	1981	Base, Conquista, Royal Knight, SS	US1121	4.3L V6 4293cc 262 CID	2013-2014	Base	US5077
4.4L V8 267 CID	1981	Base, Conquista, Royal Knight, SS; High performance	US1121H	5.0L V8 305 CID	1996-2000	Base, LS	US5077
4.4L V8 267 CID	1982	Base, Conquista, SS	US1121	5.0L V8 305 CID	1996-2002	Base, LS; High performance	US5077H
4.4L V8 267 CID	1982	Base, Conquista, SS; High performance	US1121H	5.0L V8 305 CID	2001-2002	Base, LS, LT	US5077
4.6L V8 4638cc 283 CID	1959-1960		US898	5.3L V8 5328cc 325 CID	2003-2005	Base, LS	US64
4.6L V8 4638cc 283 CID	1959-1960	High performance	US898H	5.3L V8 5328cc 325 CID	2003-2005	Base, LS; Includes thermostat and thermostat housing	US64-T
4.6L V8 4638cc 283 CID	1964-1967		US898	5.3L V8 5328cc 325 CID	2006	Base, LS, LT	US64
4.6L V8 4638cc 283 CID	1964-1967	High performance	US898H	5.3L V8 5328cc 325 CID	2006	Base, LS, LT; Includes thermostat and thermostat housing	US64-T
5.0L V8 305 CID	1976		US1109	5.3L V8 5328cc 325 CID	2007	LS, LT	US6009
5.0L V8 305 CID	1976	High performance	US1109H	5.3L V8 5328cc 325 CID	2007	LS, LT; Includes thermostat and thermostat housing	US6009-T
5.0L V8 305 CID	1977-1979		US1121	5.3L V8 5328cc 325 CID	2008-2014	Base, LS, LT	US6009
5.0L V8 305 CID	1977-1979	High performance	US1121H	5.3L V8 5328cc 325 CID	2008-2014	Base, LS, LT; Includes thermostat and thermostat housing	US6009-T
5.0L V8 305 CID	1980	Base, Royal Knight, SS	US1121	5.7L V8 350 CID	1996-2000	Base, LS	US5077
5.0L V8 305 CID	1980	Base, Royal Knight, SS; High performance	US1121H	5.7L V8 350 CID	1996-2002	Base, LS; High performance	US5077H
5.0L V8 305 CID	1981	Base, Conquista, Royal Knight, SS	US1121	5.7L V8 350 CID	2001-2002	Base, LS, LT	US5077
5.0L V8 305 CID	1981	Base, Conquista, Royal Knight, SS; High performance	US1121H	<b>EXPRESS 2500</b>			
5.0L V8 305 CID	1982-1986	Base, Conquista, SS	US1121	2.8L L4 171 CID	2017	Base, LS, LT	US8154
5.0L V8 305 CID	1982-1986	Base, Conquista, SS; High performance	US1121H	4.3L V6 262 CID	1996-1997	Base, LS; High performance	US5077H
5.0L V8 305 CID	1987	Base, SS	US1121	4.3L V6 262 CID	1996-2001	Base	US5077
5.0L V8 305 CID	1987	Base, SS; High performance	US1121H	4.3L V6 262 CID	1998	Base; High performance	US5077H
5.0L V8 307 CID	1968-1972		US898	4.3L V6 262 CID	1999-2005	Base, LS; High performance	US5077H
5.0L V8 307 CID	1968-1972	High performance	US898H	4.3L V6 262 CID	2002-2005	Base, LS	US5077
5.0L V8 5031cc 307 CID	1968-1972		US898	4.8L V8 294 CID	2003-2005	Base, LS	US64
5.0L V8 5031cc 307 CID	1968-1972	High performance	US898H	4.8L V8 294 CID	2003-2005	Base, LS; Includes thermostat and thermostat housing	US64-T
5.3L V8 5358cc 327 CID	1966-1969		US898	4.8L V8 294 CID	2006	Base, LS, LT	US64
5.3L V8 5358cc 327 CID	1966-1969	High performance	US898H	4.8L V8 294 CID	2006	Base, LS, LT; Includes thermostat and thermostat housing	US64-T
5.4L V8 327 CID	1968		US898	4.8L V8 294 CID	2007-2011	Base	US6009
5.4L V8 327 CID	1968	High performance	US898H	4.8L V8 294 CID	2007-2011	Base; Includes thermostat and thermostat housing	US6009-T
5.7L V8 350 CID	1969-1972		US898	4.8L V8 294 CID	2012-2014	Base, LS, LT; Includes thermostat and thermostat housing	US6009-T
5.7L V8 350 CID	1969-1972	High performance	US898H	4.8L V8 294 CID	2012-2017	Base, LS, LT	US6009
5.7L V8 350 CID	1976		US1109	5.0L V8 305 CID	1996-2002	Base, LS	US5077
5.7L V8 350 CID	1976	High performance	US1109H	5.0L V8 305 CID	1996-2002	Base, LS; High performance	US5077H
5.7L V8 350 CID	1977-1979		US1121	5.3L V8 5328cc 325 CID	2003-2005	Base, LS	US64

WATER PUMPS



# WATER PUMP APPLICATION GUIDE



Engine	Years	Application Description	USMWW	Engine	Years	Application Description	USMWW
<b>CHEVROLET (cont'd.)</b>				<b>CHEVROLET (cont'd.)</b>			
<b>EXPRESS 2500 (cont'd.)</b>				<b>G10 (cont'd.)</b>			
5.3L V8 5328cc 325 CID	2003-2005	Base, LS; Includes thermostat and thermostat housing	<b>US64-T</b>	5.0L V8 305 CID	1984	Beauville, Bonaventure, Chevy Van, Sportvan	<b>US1121</b>
5.7L V8 350 CID	1996-2002	Base, LS	<b>US5077</b>	5.0L V8 305 CID	1984	Beauville, Bonaventure, Chevy Van, Sportvan; High performance	<b>US1121H</b>
5.7L V8 350 CID	1996-2002	Base, LS; High performance	<b>US5077H</b>	5.0L V8 305 CID	1985	Beauville, Chevy Van, Sportvan	<b>US1121</b>
6.0L V8 5967cc 364 CID	2003-2005	Base, LS	<b>US64</b>	5.0L V8 305 CID	1985-1986	Beauville, Chevy Van, Sportvan; High performance	<b>US1121H</b>
6.0L V8 5967cc 364 CID	2003-2005	Base, LS; Includes thermostat and thermostat housing	<b>US64-T</b>	5.0L V8 305 CID	1986	Beauville, Bonaventure, Chevy Van, Sportvan	<b>US1121</b>
6.0L V8 5967cc 364 CID	2006	Base, LS, LT	<b>US64</b>	5.0L V8 305 CID	1987	Beauville, Bonaventure, Chevy Van, Sportvan	<b>US5049</b>
6.0L V8 5967cc 364 CID	2006	Base, LS, LT; Includes thermostat and thermostat housing	<b>US64-T</b>	5.0L V8 305 CID	1987	Beauville, Bonaventure, Chevy Van, Sportvan; High performance	<b>US5049H</b>
6.0L V8 5967cc 364 CID	2007-2014	Base, LS, LT; Includes thermostat and thermostat housing	<b>US6009-T</b>	5.0L V8 305 CID	1988-1995	Beauville, Chevy Van, Sportvan	<b>US5049</b>
6.0L V8 5967cc 364 CID	2007-2017	Base, LS, LT	<b>US6009</b>	5.0L V8 305 CID	1988-1995	Beauville, Chevy Van, Sportvan; High performance	<b>US5049H</b>
6.5L V8 395 CID	1996	LS	<b>US5074</b>	5.7L V8 350 CID	1975-1976		<b>US1109</b>
6.5L V8 395 CID	1997-1998	Base, LS	<b>US5074</b>	5.7L V8 350 CID	1975-1976	High performance	<b>US1109H</b>
6.5L V8 395 CID	1999-2002	Base, LS	<b>US5086</b>	5.7L V8 350 CID	1977-1979		<b>US1121</b>
6.6L V8 6599cc 403 CID	2006	Base, LS, LT	<b>US72</b>	5.7L V8 350 CID	1977-1979	High performance	<b>US1121H</b>
6.6L V8 6599cc 403 CID	2007-2016	Base	<b>US72</b>	5.7L V8 350 CID	1980	Beauville, Chevy Van, Sportvan	<b>US1121</b>
<b>EXPRESS 3500</b>				<b>G10 VAN</b>			
2.8L L4 171 CID	2017	Base, LS, LT	<b>US8154</b>	5.0L V8 307 CID	1968-1972		<b>US898</b>
4.8L V8 294 CID	2005	Base, LS	<b>US64</b>	5.0L V8 307 CID	1968-1972	High performance	<b>US898H</b>
4.8L V8 294 CID	2005	Base, LS; Includes thermostat and thermostat housing	<b>US64-T</b>	5.7L V8 350 CID	1970-1972		<b>US898</b>
4.8L V8 294 CID	2006	Base	<b>US64</b>	5.7L V8 350 CID	1970-1972	High performance	<b>US898H</b>
4.8L V8 294 CID	2006	Base; Includes thermostat and thermostat housing	<b>US64-T</b>	<b>G20</b>			
4.8L V8 294 CID	2007-2011	Base	<b>US6009</b>	4.1L L6 250 CID	1975-1979		<b>US1107</b>
4.8L V8 294 CID	2007-2011	Base; Includes thermostat and thermostat housing	<b>US6009-T</b>	4.1L L6 250 CID	1980-1982	Beauville, Chevy Van, Sportvan	<b>US1107</b>
4.8L V8 294 CID	2012-2014	Base, LS, LT; Includes thermostat and thermostat housing	<b>US6009-T</b>	4.1L L6 250 CID	1983-1984	Beauville, Bonaventure, Chevy Van, Sportvan	<b>US1107</b>
4.8L V8 294 CID	2012-2017	Base, LS, LT	<b>US6009</b>	4.3L V6 262 CID	1985-1986	Beauville, Chevy Van, Sportvan	<b>US1121</b>
5.7L V8 350 CID	1996-2002	Base, LS	<b>US5077</b>	4.3L V6 262 CID	1985-1986	Beauville, Chevy Van, Sportvan; High performance	<b>US1121H</b>
5.7L V8 350 CID	1996-2002	Base, LS; High performance	<b>US5077H</b>	4.3L V6 262 CID	1987-1995	Beauville, Chevy Van, Sportvan	<b>US5049</b>
5.7L V8 350 CID	2001	Base; (R)	<b>US5077</b>	4.3L V6 262 CID	1987-1995	Beauville, Chevy Van, Sportvan; High performance	<b>US5049H</b>
6.0L V8 5967cc 364 CID	2003-2005	Base, LS	<b>US64</b>	4.8L L6 292 CID	1975-1977		<b>US1137</b>
6.0L V8 5967cc 364 CID	2003-2005	Base, LS; Includes thermostat and thermostat housing	<b>US64-T</b>	4.8L L6 292 CID	1975-1977	High performance	<b>US1137H</b>
6.0L V8 5967cc 364 CID	2006	Base, LS, LT	<b>US64</b>	4.8L L6 292 CID	1978		<b>US5030</b>
6.0L V8 5967cc 364 CID	2006	Base, LS, LT; Includes thermostat and thermostat housing	<b>US64-T</b>	4.8L L6 292 CID	1980	Beauville, Chevy Van	<b>US5030</b>
6.0L V8 5967cc 364 CID	2007-2014	Base, LS, LT; Includes thermostat and thermostat housing	<b>US6009-T</b>	5.0L V8 305 CID	1977-1979		<b>US1121</b>
6.0L V8 5967cc 364 CID	2007-2017	Base, LS, LT	<b>US6009</b>	5.0L V8 305 CID	1977-1979	High performance	<b>US1121H</b>
6.5L V8 395 CID	1996-1998	Base, LS	<b>US5074</b>	5.0L V8 305 CID	1980	Beauville, Chevy Van	<b>US1121</b>
6.5L V8 395 CID	1999-2002	Base, LS	<b>US5086</b>	5.0L V8 305 CID	1980	Beauville, Chevy Van; High performance	<b>US1121H</b>
6.6L V8 6599cc 403 CID	2006-2014	Base	<b>US72</b>	5.0L V8 305 CID	1981-1982	Beauville, Chevy Van, Sportvan	<b>US1121</b>
6.6L V8 6599cc 403 CID	2015-2016	Base, LS, LT	<b>US72</b>	5.0L V8 305 CID	1981-1982	Beauville, Chevy Van, Sportvan; High performance	<b>US1121H</b>
7.4L V8 454 CID	1996-2000	Base, LS	<b>US5038</b>	5.0L V8 305 CID	1983-1984	Beauville, Bonaventure, Chevy Van, Sportvan	<b>US1121</b>
7.4L V8 454 CID	1996-2000	Base, LS; High performance	<b>US5038H</b>	5.0L V8 305 CID	1983-1984	Beauville, Bonaventure, Chevy Van, Sportvan; High performance	<b>US1121H</b>
8.1L V8 496 CID	2001-2002	Base, LS	<b>US5090</b>	5.0L V8 305 CID	1985-1986	Beauville, Chevy Van, Sportvan	<b>US1121</b>
<b>EXPRESS 4500</b>				<b>G20</b>			
6.0L V8 5967cc 364 CID	2015-2016	Base	<b>US6009</b>	4.1L L6 250 CID	1975-1979		<b>US1107</b>
6.6L V8 6599cc 403 CID	2009-2014	Base, Medium/Heavy Duty	<b>US72</b>	4.1L L6 250 CID	1980-1982	Beauville, Chevy Van, Sportvan	<b>US1107</b>
6.6L V8 6599cc 403 CID	2015-2016	Base	<b>US72</b>	4.1L L6 250 CID	1983-1984	Beauville, Bonaventure, Chevy Van, Sportvan	<b>US1107</b>
6L V8 5967cc 364 CID	2009-2014	Base, Medium/Heavy Duty	<b>US6009</b>	4.3L V6 262 CID	1985-1986	Beauville, Chevy Van, Sportvan	<b>US1121</b>
6L V8 5967cc 364 CID	2009-2014	Base, Includes thermostat and thermostat housing, Medium/Heavy Duty	<b>US6009-T</b>	4.3L V6 262 CID	1985-1986	Beauville, Chevy Van, Sportvan; High performance	<b>US1121H</b>
<b>G10</b>				4.3L V6 262 CID	1987-1995	Beauville, Chevy Van, Sportvan	<b>US5049</b>
4.1L L6 250 CID	1975-1976		<b>US1110</b>	4.3L V6 262 CID	1987-1995	Beauville, Chevy Van, Sportvan; High performance	<b>US5049H</b>
4.1L L6 250 CID	1977-1979		<b>US1107</b>	4.8L L6 292 CID	1975-1977	High performance	<b>US1137</b>
4.1L L6 250 CID	1980-1982	Beauville, Chevy Van, Sportvan	<b>US1107</b>	4.8L L6 292 CID	1975-1977	High performance	<b>US1137H</b>
4.1L L6 250 CID	1983	Base, Beauville, Bonaventure, Chevy Van, Sportvan	<b>US1107</b>	4.8L L6 292 CID	1978		<b>US5030</b>
4.1L L6 250 CID	1984	Beauville, Bonaventure, Chevy Van, Sportvan	<b>US1107</b>	4.8L L6 292 CID	1980	Beauville, Chevy Van	<b>US5030</b>
4.3L V6 262 CID	1985	Beauville, Chevy Van, Sportvan	<b>US1121</b>	5.0L V8 305 CID	1977-1979		<b>US1121</b>
4.3L V6 262 CID	1985-1986	Beauville, Chevy Van, Sportvan; High performance	<b>US1121H</b>	5.0L V8 305 CID	1977-1979	High performance	<b>US1121H</b>
4.3L V6 262 CID	1986	Beauville, Bonaventure, Chevy Van, Sportvan	<b>US1121</b>	5.0L V8 305 CID	1980	Beauville, Chevy Van; High performance	<b>US1121H</b>
4.3L V6 262 CID	1987	Beauville, Bonaventure, Chevy Van, Sportvan	<b>US5049</b>	5.0L V8 305 CID	1981-1982	Beauville, Chevy Van, Sportvan	<b>US1121</b>
4.3L V6 262 CID	1987	Beauville, Bonaventure, Chevy Van, Sportvan; High performance	<b>US5049H</b>	5.0L V8 305 CID	1981-1982	Beauville, Chevy Van, Sportvan; High performance	<b>US1121H</b>
4.3L V6 262 CID	1988-1995	Beauville, Chevy Van, Sportvan	<b>US5049</b>	5.0L V8 305 CID	1983-1984	Beauville, Bonaventure, Chevy Van, Sportvan	<b>US1121</b>
4.3L V6 262 CID	1988-1995	Beauville, Chevy Van, Sportvan; High performance	<b>US5049H</b>	5.0L V8 305 CID	1983-1984	Beauville, Bonaventure, Chevy Van, Sportvan; High performance	<b>US1121H</b>
5.0L V8 305 CID	1977-1979		<b>US1121</b>	5.0L V8 305 CID	1985-1986	Beauville, Chevy Van, Sportvan	<b>US1121</b>
5.0L V8 305 CID	1977-1979	High performance	<b>US1121H</b>	5.0L V8 305 CID	1985-1986	Beauville, Chevy Van, Sportvan; High performance	<b>US1121H</b>
5.0L V8 305 CID	1980-1982	Beauville, Chevy Van, Sportvan	<b>US1121</b>	5.0L V8 305 CID	1987-1995	Beauville, Chevy Van, Sportvan	<b>US5049</b>
5.0L V8 305 CID	1980-1982	Beauville, Chevy Van, Sportvan; High performance	<b>US1121H</b>	5.0L V8 305 CID	1987-1995	Beauville, Chevy Van, Sportvan; High performance	<b>US5049H</b>
5.0L V8 305 CID	1983	Base, Beauville, Bonaventure, Chevy Van, Sportvan	<b>US1121</b>	5.7L V8 350 CID	1975-1976		<b>US1109</b>
5.0L V8 305 CID	1983	High performance	<b>US1121H</b>	5.7L V8 350 CID	1975-1976	High performance	<b>US1109H</b>
5.0L V8 305 CID	1980-1982	Beauville, Chevy Van, Sportvan	<b>US1121</b>	5.7L V8 350 CID	1977-1979		<b>US1121</b>
5.0L V8 305 CID	1980-1982	Beauville, Chevy Van, Sportvan; High performance	<b>US1121H</b>	5.7L V8 350 CID	1977-1979	High performance	<b>US1121H</b>
5.0L V8 305 CID	1983	Base, Beauville, Bonaventure, Chevy Van, Sportvan	<b>US1121</b>	5.7L V8 350 CID	1980-1982	Beauville, Chevy Van, Sportvan	<b>US1121</b>
5.0L V8 305 CID	1983	Base, Beauville, Bonaventure, Chevy Van, Sportvan; High performance	<b>US1121H</b>	5.7L V8 350 CID	1980-1982	Beauville, Chevy Van, Sportvan; High performance	<b>US1121H</b>
5.0L V8 305 CID	1983	Base, Beauville, Bonaventure, Chevy Van, Sportvan	<b>US1121</b>	5.7L V8 350 CID	1983	Sportvan	<b>US1121</b>
5.0L V8 305 CID	1983	Base, Beauville, Bonaventure, Chevy Van, Sportvan; High performance	<b>US1121H</b>	5.7L V8 350 CID	1983	Sportvan; High performance	<b>US1121H</b>
				5.7L V8 350 CID	1983	Sportvan; High performance	<b>US1121H</b>
				5.7L V8 350 CID	1984	Beauville, Bonaventure, Chevy Van, Sportvan	<b>US1121</b>
				5.7L V8 350 CID	1984	Beauville, Bonaventure, Chevy Van, Sportvan; High performance	<b>US1121H</b>
				5.7L V8 350 CID	1985-1986	Beauville, Chevy Van, Sportvan	<b>US1121</b>
				5.7L V8 350 CID	1985-1986	Beauville, Chevy Van, Sportvan; High performance	<b>US1121H</b>
				5.7L V8 350 CID	1987-1995	Beauville, Chevy Van, Sportvan	<b>US5049</b>
				5.7L V8 350 CID	1987-1995	Beauville, Chevy Van, Sportvan; High performance	<b>US5049H</b>

Engine	Years	Application Description	USMW	Engine	Years	Application Description	USMW
<b>CHEVROLET (cont'd.)</b>				<b>CHEVROLET (cont'd.)</b>			
<b>G20 (cont'd.)</b>				<b>G30 (cont'd.)</b>			
6.2L V8 379 CID	1983-1984	Beauville, Bonaventure, Chevy Van, Sportvan	US5008	7.4L V8 454 CID	1988-1996	Beauville, Chevy Van, Hi-Cube, Sportvan	US5038
6.2L V8 379 CID	1985-1993	Beauville, Chevy Van, Sportvan	US5008	7.4L V8 454 CID	1988-1996	Beauville, Chevy Van, Hi-Cube, Sportvan; High performance	US5038H
6.5L V8 395 CID	1994-1995	Beauville, Chevy Van, Sportvan	US5062	<b>G30 VAN</b>			
6.6L V8 400 CID	1975-1976		US1109	<b>G30 VAN</b>			
6.6L V8 400 CID	1975-1976	High performance	US1109H	4.8L L6 292 CID	1971-1972		US896
6.6L V8 400 CID	1977-1979		US1121	4.8L L6 292 CID	1974		US896
6.6L V8 400 CID	1977-1979	High performance	US1121H	4.8L L6 4786cc 292 CID	1974		US896
6.6L V8 400 CID	1980	Beauville, Chevy Van, Sportvan	US1121	5.7L V8 350 CID	1970-1972		US898
6.6L V8 400 CID	1980	Beauville, Chevy Van, Sportvan; High performance	US1121H	5.7L V8 350 CID	1970-1972	High performance	US898H
<b>G20 VAN</b>				<b>HHR</b>			
4.6L V8 4638cc 283 CID	1967		US898	2.0L L4 1998cc 122 CID	2008	SS	US5092
4.6L V8 4638cc 283 CID	1967	High performance	US898H	2.0L L4 1998cc 122 CID	2009	SS, SS Panel	US5092
4.8L L6 292 CID	1971		US896	2.0L L4 1998cc 122 CID	2010	SS	US5092
4.8L L6 292 CID	1973-1974		US896	2.2L L4 2198cc 134 CID	2006	LS, LT	US5092
4.8L L6 4786cc 292 CID	1973-1974		US896	2.2L L4 2198cc 134 CID	2007-2010	LS, LS Panel, LT, LT Panel	US5092
4.8L L6 4801cc 292 CID	1971-1974		US896	2.2L L4 2198cc 134 CID	2011	LS, LS Panel, LT	US5092
5.0L V8 307 CID	1968-1970		US898	2.4L L4 2384cc 145 CID	2006	LT	US5092
5.0L V8 307 CID	1968-1970	High performance	US898H	2.4L L4 2384cc 145 CID	2007-2010	LT, LT Panel	US5092
5.0L V8 5031cc 307 CID	1968-1972		US898	2.4L L4 2384cc 145 CID	2011	LT	US5092
5.0L V8 5031cc 307 CID	1968-1972	High performance	US898H	<b>IMPALA</b>			
5.7L V8 350 CID	1970-1972		US898	2.4L L4 2384cc 145 CID	2014	Eco	US5092
5.7L V8 350 CID	1970-1972	High performance	US898H	2.5L L4 2457cc 153 CID	2014-2015	LS, LT, LTZ; Pump only	US8102
5.7L V8 5736cc 350 CID	1970-1972		US898	2.5L L4 2457cc 153 CID	2015-2016	LS, LT, LTZ	US8102
5.7L V8 5736cc 350 CID	1970-1972	High performance	US898H	2.5L L4 2457cc 153 CID	2017	LS, LT	US8102
<b>G30</b>				3.4L V6 207 CID	2000-2005	Base	US5033
4.1L L6 250 CID	1981-1982	Beauville, Chevy Van, Hi-Cube	US1107	3.5L V6 3490cc 213 CID	2006-2007	LS, LT	US6020
4.1L L6 250 CID	1983-1984	Beauville, Bonaventure, Chevy Van, Hi-Cube	US1107	3.5L V6 3490cc 213 CID	2008	50th Anniversary Edition, LS, LT	US6020
4.3L V6 262 CID	1985-1986	Beauville, Chevy Van, Hi-Cube	US1121	3.5L V6 3490cc 213 CID	2009-2011	LS, LT	US6020
4.3L V6 262 CID	1985-1986	Beauville, Chevy Van, Hi-Cube; High performance	US1121H	3.6L V6 3564cc 217 CID	2012	LS, LT, LTZ	US8932
4.3L V6 262 CID	1987-1993	Beauville, Chevy Van, Hi-Cube	US5049	3.6L V6 3564cc 217 CID	2013	LS, LT, LTZ, Police	US8932
4.3L V6 262 CID	1987-1993	Beauville, Chevy Van, Hi-Cube; High performance	US5049H	3.6L V6 3564cc 217 CID	2015-2016	LS, LT, LTZ	US8932
4.3L V6 262 CID	1994-1995	Chevy Van, Hi-Cube	US5049	3.6L V6 3564cc 217 CID	2017	LS, LT, Premier	US8932
4.3L V6 262 CID	1994-1995	Chevy Van, Hi-Cube; High performance	US5049H	3.8L V6 229 CID	1980	Base, Sport	US1121
4.3L V6 262 CID	1996	Chevy Van	US5049	3.8L V6 229 CID	1980	Base, Sport; High performance	US1121H
4.3L V6 262 CID	1996	Chevy Van; High performance	US5049H	3.8L V6 229 CID	1981-1982	Base, Estate	US1121
4.8L L6 292 CID	1975-1977		US1137	3.8L V6 229 CID	1981-1982	Base, Estate; High performance	US1121H
4.8L L6 292 CID	1975-1977	High performance	US1137H	3.8L V6 229 CID	1983-1984	Base	US1121
4.8L L6 292 CID	1978		US5030	3.8L V6 229 CID	1983-1984	Base; High performance	US1121H
5.0L V8 305 CID	1978-1979		US1121	3.8L V6 229 CID	1983-1984	Base; High performance	US1121H
5.0L V8 305 CID	1978-1979	High performance	US1121H	3.8L V6 3800cc 231 CID	1980	Base, Sport	US1018
5.0L V8 305 CID	1982	Beauville, Chevy Van, Hi-Cube	US1121	3.8L V6 3800cc 231 CID	1980	Base, Sport; High performance	US1018H
5.0L V8 305 CID	1982	Beauville, Chevy Van, Hi-Cube; High performance	US1121H	3.8L V6 3800cc 231 CID	1981-1982	Base, Estate	US1018
5.0L V8 305 CID	1985	Beauville, Chevy Van, Hi-Cube	US1121	3.8L V6 3800cc 231 CID	1981-1982	Base, Estate; High performance	US1018H
5.0L V8 305 CID	1985	Beauville, Chevy Van, Hi-Cube; High performance	US1121H	3.8L V6 3800cc 231 CID	1983-1984	Base	US1018
5.7L V8 350 CID	1975-1976		US1109	3.8L V6 3800cc 231 CID	1983-1984	Base; High performance	US1018H
5.7L V8 350 CID	1975-1976	High performance	US1109H	3.8L V6 3800cc 231 CID	2000-2002	Base, LS	US5075
5.7L V8 350 CID	1977-1979		US1121	3.8L V6 3800cc 231 CID	2003	Base, LS, LS Sport	US5075
5.7L V8 350 CID	1977-1979	High performance	US1121H	3.8L V6 3800cc 231 CID	2004-2005	Base, LS, SS	US5075
5.7L V8 350 CID	1980-1982	Beauville, Chevy Van, Hi-Cube, Sportvan	US1121	3.9L V6 3880cc 237 CID	2006-2007	LT, LTZ	US6020
5.7L V8 350 CID	1980-1982	Beauville, Chevy Van, Hi-Cube, Sportvan; High performance	US1121H	3.9L V6 3880cc 237 CID	2008-2009	LT, LTZ, Police	US6020
5.7L V8 350 CID	1983-1984	Beauville, Bonaventure, Chevy Van, Hi-Cube, Sportvan	US1121	3.9L V6 3880cc 237 CID	2010-2011	LS, LTZ	US6020
5.7L V8 350 CID	1983-1984	Beauville, Bonaventure, Chevy Van, Hi-Cube, Sportvan; High performance	US1121H	4.1L L6 250 CID	1977-1979		US1107
5.7L V8 350 CID	1985-1986	Beauville, Chevy Van, Hi-Cube, Sportvan	US1121	4.1L L6 4100cc 250 CID	1965	Mexican Application	US895
5.7L V8 350 CID	1985-1986	Beauville, Chevy Van, Hi-Cube, Sportvan; High performance	US1121H	4.1L L6 4100cc 250 CID	1975-1976	Mexican Application	US1110
5.7L V8 350 CID	1987-1988	Beauville, Chevy Van, Hi-Cube	US1121	4.3L V6 262 CID	1985	Base	US1121
5.7L V8 350 CID	1987-1988	Beauville, Chevy Van, Hi-Cube; High performance	US1121H	4.3L V6 262 CID	1985	Base; High performance	US1121H
5.7L V8 350 CID	1987-1988	Beauville, Chevy Van, Hi-Cube; High performance	US1121H	4.4L V8 267 CID	1980	Base, Sport	US1121
5.7L V8 350 CID	1987-1996	Beauville, Chevy Van, Hi-Cube, Sportvan	US5049	4.4L V8 267 CID	1980	Base, Sport; High performance	US1121H
5.7L V8 350 CID	1987-1996	Beauville, Chevy Van, Hi-Cube, Sportvan; High performance	US5049H	4.4L V8 267 CID	1981-1982	Base, Estate	US1121
6.2L V8 379 CID	1983-1984	Beauville, Bonaventure, Chevy Van, Hi-Cube, Sportvan	US5008	4.4L V8 267 CID	1981-1982	Base, Estate; High performance	US1121H
6.2L V8 379 CID	1985-1993	Beauville, Chevy Van, Hi-Cube, Sportvan	US5008	4.6L V8 283 CID	1964		US898
6.5L V8 395 CID	1994-1996	Beauville, Chevy Van, Hi-Cube, Sportvan	US5062	4.6L V8 283 CID	1964	High performance	US898H
6.6L V8 400 CID	1975-1976		US1109	4.6L V8 283 CID	1966-1967		US898
6.6L V8 400 CID	1975-1976	High performance	US1109H	4.6L V8 283 CID	1966-1967	High performance	US898H
6.6L V8 400 CID	1977-1979		US1121	4.6L V8 4638cc 283 CID	1958-1967		US898
6.6L V8 400 CID	1977-1979	High performance	US1121H	4.6L V8 4638cc 283 CID	1958-1967	High performance	US898H
6.6L V8 400 CID	1980	Beauville, Chevy Van, Hi-Cube, Sportvan	US1121	4.8L L6 4800cc 292 CID	1965-1972	Mexican Application	US895
6.6L V8 400 CID	1980	Beauville, Chevy Van, Hi-Cube, Sportvan; High performance	US1121H	5.0L V8 305 CID	1977-1979		US1121
				5.0L V8 305 CID	1977-1979	High performance	US1121H
				5.0L V8 305 CID	1980	Base, Sport	US1121
				5.0L V8 305 CID	1980	Base, Sport; High performance	US1121H
				5.0L V8 305 CID	1981-1982	Base, Estate	US1121
				5.0L V8 305 CID	1981-1982	Base, Estate; High performance	US1121H
				5.0L V8 305 CID	1983-1985	Base	US1121
				5.0L V8 305 CID	1983-1985	Base; High performance	US1121H
				5.0L V8 307 CID	1968		US898
				5.0L V8 307 CID	1968	High performance	US898H
				5.0L V8 5031cc 307 CID	1968-1969		US898
				5.0L V8 5031cc 307 CID	1968-1969	High performance	US898H
				5.0L V8 5031cc 307 CID	1971-1972		US898
				5.0L V8 5031cc 307 CID	1971-1972	High performance	US898H
				5.3L V8 5328cc 325 CID	2006-2009	SS	US6154
				5.3L V8 5358cc 327 CID	1962-1969		US898
				5.3L V8 5358cc 327 CID	1962-1969	High performance	US898H
				5.4L V8 327 CID	1964-1969		US898

WATER PUMPS



Engine	Years	Application Description	USMW	Engine	Years	Application Description	USMW
<b>CHEVROLET (cont'd.)</b>				<b>CHEVROLET (cont'd.)</b>			
<b>IMPALA (cont'd.)</b>				<b>K5 BLAZER (cont'd.)</b>			
5.4L V8 327 CID	1964-1969	High performance	<b>US898H</b>	5.7L V8 350 CID	1980	Cheyenne, Custom Deluxe, Silverado; High performance	<b>US1121H</b>
5.7L V8 350 CID	1969-1972		<b>US898</b>	5.7L V8 350 CID	1981	Custom, Deluxe, Silverado	<b>US1121</b>
5.7L V8 350 CID	1969-1972	High performance	<b>US898H</b>	5.7L V8 350 CID	1981	Custom, Deluxe, Silverado; High performance	<b>US1121H</b>
5.7L V8 350 CID	1976		<b>US1109</b>	5.7L V8 350 CID	1982-1983	Custom, Silverado	<b>US1121</b>
5.7L V8 350 CID	1976	High performance	<b>US1109H</b>	5.7L V8 350 CID	1982-1983	Custom, Silverado; High performance	<b>US1121H</b>
5.7L V8 350 CID	1977-1979		<b>US1121</b>	5.7L V8 350 CID	1984	Custom, Scottsdale, Silverado	<b>US1121</b>
5.7L V8 350 CID	1977-1979	High performance	<b>US1121H</b>	5.7L V8 350 CID	1984	Custom, Scottsdale, Silverado; High performance	<b>US1121H</b>
5.7L V8 350 CID	1980	Base, Sport; Exc.Air Cond	<b>US1100</b>	5.7L V8 350 CID	1985-1986	Custom, Silverado	<b>US1121</b>
5.7L V8 350 CID	1980	Base, Sport; With air cond.	<b>US1120</b>	5.7L V8 350 CID	1985-1986	Custom, Silverado; High performance	<b>US1121H</b>
5.7L V8 350 CID	1980	Base, Sport; High performance, With air cond.	<b>US1120H</b>	6.2L V8 379 CID	1982-1983	Custom, Silverado	<b>US5008</b>
5.7L V8 350 CID	1980	Base, Sport	<b>US1121</b>	6.2L V8 379 CID	1984	Custom, Scottsdale, Silverado	<b>US5008</b>
5.7L V8 350 CID	1980	Base, Sport; High performance	<b>US1121H</b>	6.2L V8 379 CID	1985-1986	Custom, Silverado	<b>US5008</b>
5.7L V8 350 CID	1981	Base, Estate; Exc.Air Cond	<b>US1100</b>	6.6L V8 400 CID	1975-1976		<b>US1109</b>
5.7L V8 350 CID	1981-1982	Base, Estate; With air cond.	<b>US1120</b>	6.6L V8 400 CID	1975-1976	High performance	<b>US1109H</b>
5.7L V8 350 CID	1981-1982	Base, Estate; High performance, With air cond.	<b>US1120H</b>	6.6L V8 400 CID	1977-1979		<b>US1121</b>
5.7L V8 350 CID	1981-1982	Base, Estate	<b>US1121</b>	6.6L V8 400 CID	1977-1979	High performance	<b>US1121H</b>
5.7L V8 350 CID	1981-1982	Base, Estate; High performance	<b>US1121H</b>	<b>K10</b>			
5.7L V8 350 CID	1982	Base, Estate; 5" Cast, Exc.Air Cond	<b>US1100</b>	4.1L L6 250 CID	1975-1977		<b>US1110</b>
5.7L V8 350 CID	1982	Base, Estate; Exc.5" Cast, Exc.Air Cond	<b>US1120</b>	4.1L L6 250 CID	1978-1979		<b>US1107</b>
5.7L V8 350 CID	1982	Base, Estate; Exc.5" Cast, Exc.Air Cond, High performance	<b>US1120H</b>	4.1L L6 250 CID	1980	Cheyenne, Custom Deluxe, Scottsdale, Silverado	<b>US1107</b>
5.7L V8 350 CID	1983-1985	Base; 5" Cast, Exc.Air Cond	<b>US1100</b>	4.1L L6 250 CID	1981	Custom, Deluxe	<b>US1107</b>
5.7L V8 350 CID	1983-1985	Base, Exc.5" Cast, Exc.Air Cond	<b>US1120</b>	4.1L L6 250 CID	1982	Custom, Scottsdale, Silverado	<b>US1107</b>
5.7L V8 350 CID	1983-1985	Base; With air cond.	<b>US1120</b>	4.1L L6 250 CID	1983	Custom, Silverado	<b>US1107</b>
5.7L V8 350 CID	1983-1985	Base; Exc.5" Cast, Exc.Air Cond, High performance	<b>US1120H</b>	4.1L L6 250 CID	1984	Custom, Scottsdale	<b>US1107</b>
5.7L V8 350 CID	1983-1985	Base; High performance, With air cond.	<b>US1120H</b>	4.3L V6 262 CID	1985-1986	Custom, Scottsdale, Silverado	<b>US1121</b>
5.7L V8 350 CID	1983-1985	Base	<b>US1121</b>	4.3L V6 262 CID	1985-1986	Custom, Scottsdale, Silverado; High performance	<b>US1121H</b>
5.7L V8 350 CID	1983-1985	Base; High performance	<b>US1121H</b>	4.8L L6 292 CID	1980	Cheyenne, Custom Deluxe, Scottsdale, Silverado	<b>US5030</b>
5.7L V8 350 CID	1994-1996	SS	<b>US5069</b>	5.0L V8 305 CID	1977-1979		<b>US1121</b>
5.7L V8 5704cc 348 CID	1958-1961		<b>US898</b>	5.0L V8 305 CID	1977-1979	High performance	<b>US1121H</b>
5.7L V8 5704cc 348 CID	1958-1961	High performance	<b>US898H</b>	5.0L V8 305 CID	1981	Custom, Deluxe	<b>US1121</b>
5.7L V8 5704cc 348 CID	1959-1961		<b>US127</b>	5.0L V8 305 CID	1981	Custom, Deluxe; High performance	<b>US1121H</b>
5.7L V8 5736cc 350 CID	1969-1972		<b>US898</b>	5.0L V8 305 CID	1982	Custom, Scottsdale, Silverado	<b>US1121</b>
5.7L V8 5736cc 350 CID	1969-1972	High performance	<b>US898H</b>	5.0L V8 305 CID	1982	Custom, Scottsdale, Silverado; High performance	<b>US1121H</b>
6.5L V8 396 CID	1966-1969		<b>US981</b>	5.0L V8 305 CID	1983	Custom, Silverado	<b>US1121</b>
6.5L V8 6489cc 396 CID	1966-1969		<b>US981</b>	5.0L V8 305 CID	1983	Custom, Silverado; High performance	<b>US1121H</b>
6.6L V8 400 CID	1970-1972		<b>US981</b>	5.0L V8 305 CID	1984	Custom, Scottsdale	<b>US1121</b>
6.6L V8 400 CID	1975-1976	High performance	<b>US1109</b>	5.0L V8 305 CID	1984	Custom, Scottsdale; High performance	<b>US1121H</b>
6.6L V8 400 CID	1975-1976		<b>US1109H</b>	5.0L V8 305 CID	1985-1986	Custom, Scottsdale, Silverado	<b>US1121</b>
6.6L V8 402 CID	1971-1972		<b>US981</b>	5.0L V8 305 CID	1985-1986	Custom, Scottsdale, Silverado; High performance	<b>US1121H</b>
6.6L V8 6556cc 400 CID	1970-1972		<b>US981</b>	5.7L V8 350 CID	1975-1976		<b>US1109</b>
6.6L V8 6556cc 400 CID	1970-1972		<b>US981</b>	5.7L V8 350 CID	1975-1976	High performance	<b>US1109H</b>
6.6L V8 6588cc 402 CID	1970-1972		<b>US981</b>	5.7L V8 350 CID	1977-1979		<b>US1121</b>
6.7L V8 6704cc 409 CID	1961-1963		<b>US127</b>	5.7L V8 350 CID	1977-1979	High performance	<b>US1121H</b>
6.7L V8 6704cc 409 CID	1964	1 3/4" mount holes 4 1/2" hub height	<b>US127</b>	5.7L V8 350 CID	1980	Cheyenne, Custom Deluxe, Scottsdale, Silverado	<b>US1121</b>
7.0L V8 427 CID	1966-1969		<b>US981</b>	5.7L V8 350 CID	1980	Cheyenne, Custom Deluxe, Scottsdale, Silverado; High performance	<b>US1121H</b>
7.0L V8 6998cc 427 CID	1966-1969		<b>US981</b>	5.7L V8 350 CID	1981	Custom, Deluxe	<b>US1121</b>
7.4L V8 454 CID	1975-1976		<b>US1002</b>	5.7L V8 350 CID	1981	Custom, Deluxe; High performance	<b>US1121H</b>
7.4L V8 454 CID	1975-1976	High performance	<b>US1002H</b>	5.7L V8 350 CID	1982	Custom, Scottsdale, Silverado	<b>US1121</b>
<b>IMPALA LIMITED</b>				5.7L V8 350 CID	1982	Custom, Scottsdale, Silverado; High performance	<b>US1121H</b>
3.6L V6 3564cc 217 CID	2014	Police	<b>US8932</b>	5.7L V8 350 CID	1983	Custom, Silverado	<b>US1121</b>
3.6L V6 3564cc 217 CID	2015-2016	LS, LT, LTZ, Police	<b>US8932</b>	5.7L V8 350 CID	1983	Custom, Silverado; High performance	<b>US1121H</b>
<b>JOY</b>				5.7L V8 350 CID	1984	Custom, Scottsdale	<b>US1121</b>
1.4L L4 1400cc 85 CID	1994-1995	Mexican Application	<b>US5057</b>	5.7L V8 350 CID	1984	Custom, Scottsdale; High performance	<b>US1121H</b>
1.6L L4 1600cc 98 CID	1996-2003	Mexican Application	<b>US5057</b>	5.7L V8 350 CID	1985-1986	Custom, Scottsdale, Silverado	<b>US1121</b>
<b>K5 BLAZER</b>				5.7L V8 350 CID	1985-1986	Custom, Scottsdale, Silverado; High performance	<b>US1121H</b>
4.1L L6 250 CID	1975-1977		<b>US1110</b>	6.2L V8 379 CID	1982	Custom, Scottsdale, Silverado	<b>US5008</b>
4.1L L6 250 CID	1978-1979		<b>US1107</b>	6.2L V8 379 CID	1983	Custom, Silverado	<b>US5008</b>
4.1L L6 250 CID	1980	Cheyenne, Custom Deluxe, Silverado	<b>US1107</b>	6.2L V8 379 CID	1984	Custom, Scottsdale	<b>US5008</b>
4.1L L6 250 CID	1981	Custom, Deluxe, Silverado	<b>US1107</b>	6.2L V8 379 CID	1985-1986	Custom, Scottsdale, Silverado	<b>US5008</b>
4.1L L6 250 CID	1982	Custom, Silverado	<b>US1107</b>	6.6L V8 400 CID	1975-1976		<b>US1109</b>
5.0L V8 305 CID	1977-1979		<b>US1121</b>	6.6L V8 400 CID	1977-1979	High performance	<b>US1109H</b>
5.0L V8 305 CID	1977-1979	High performance	<b>US1121H</b>	6.6L V8 400 CID	1977-1979	High performance	<b>US1121H</b>
5.0L V8 305 CID	1980	Cheyenne, Custom Deluxe, Silverado	<b>US1121</b>	6.6L V8 400 CID	1980	Cheyenne, Custom Deluxe, Scottsdale, Silverado	<b>US1121</b>
5.0L V8 305 CID	1980	Cheyenne, Custom Deluxe, Silverado; High performance	<b>US1121H</b>	6.6L V8 400 CID	1980	Cheyenne, Custom Deluxe, Scottsdale, Silverado; High performance	<b>US1121H</b>
5.0L V8 305 CID	1981	Custom, Deluxe, Silverado	<b>US1121</b>	7.4L V8 454 CID	1980	Cheyenne, Custom Deluxe, Scottsdale, Silverado	<b>US1002</b>
5.0L V8 305 CID	1981	Custom, Deluxe, Silverado; High performance	<b>US1121H</b>	7.4L V8 454 CID	1980	Cheyenne, Custom Deluxe, Scottsdale, Silverado; High performance	<b>US1002H</b>
5.0L V8 305 CID	1982-1983	Custom, Silverado	<b>US1121</b>	<b>K10 PICKUP</b>			
5.0L V8 305 CID	1982-1983	Custom, Silverado; High performance	<b>US1121H</b>	4.3L L6 4278cc 261 CID	1961-1962		<b>US898</b>
5.0L V8 305 CID	1984	Custom, Scottsdale, Silverado	<b>US1121</b>	4.3L L6 4278cc 261 CID	1961-1962	High performance	<b>US898H</b>
5.0L V8 305 CID	1984	Custom, Scottsdale, Silverado; High performance	<b>US1121H</b>	4.6L V8 4638cc 283 CID	1960-1967		<b>US898</b>
5.0L V8 305 CID	1985-1986	Custom, Silverado	<b>US1121</b>	4.6L V8 4638cc 283 CID	1960-1967	High performance	<b>US898H</b>
5.0L V8 305 CID	1985-1986	Custom, Silverado; High performance	<b>US1121H</b>				
5.7L V8 350 CID	1975-1976		<b>US1109</b>				
5.7L V8 350 CID	1975-1976	High performance	<b>US1109H</b>				
5.7L V8 350 CID	1977-1979		<b>US1121</b>				
5.7L V8 350 CID	1977-1979	High performance	<b>US1121H</b>				
5.7L V8 350 CID	1980	Cheyenne, Custom Deluxe, Silverado	<b>US1121</b>				

Engine	Years	Application Description	USMW	Engine	Years	Application Description	USMW
<b>CHEVROLET (cont'd.)</b>				<b>CHEVROLET (cont'd.)</b>			
<b>K10 PICKUP (cont'd.)</b>				<b>K10 SUBURBAN (cont'd.)</b>			
4.8L L6 292 CID	1969-1970		US896	6.6L V8 402 CID	1970-1972		US981
4.8L L6 292 CID	1972-1973		US896	6.6L V8 6588cc 402 CID	1970-1972		US981
4.8L L6 4786cc 292 CID	1972-1973		US896	<b>K20</b>			
4.8L L6 4801cc 292 CID	1965-1974		US896	4.1L L6 250 CID	1980	Cheyenne, Custom Deluxe, Scottsdale, Silverado	US1107
5.0L V8 307 CID	1968-1972		US898	4.3L V6 262 CID	1985	Custom, Scottsdale, Silverado	US1121
5.0L V8 307 CID	1968-1972	High performance	US898H	4.3L V6 262 CID	1985	Custom, Scottsdale, Silverado; High performance	US1121H
5.0L V8 5031cc 307 CID	1968-1972		US898	4.8L L6 292 CID	1975-1977		US1137
5.0L V8 5031cc 307 CID	1968-1972	High performance	US898H	4.8L L6 292 CID	1975-1977	High performance	US1137H
5.3L V8 5358cc 327 CID	1966-1969		US898	4.8L L6 292 CID	1978-1979		US5030
5.3L V8 5358cc 327 CID	1966-1969	High performance	US898H	4.8L L6 292 CID	1980	Cheyenne, Custom Deluxe, Scottsdale, Silverado	US5030
5.4L V8 327 CID	1968		US898	4.8L L6 292 CID	1981	Custom, Deluxe	US5030
5.4L V8 327 CID	1968	High performance	US898H	4.8L L6 292 CID	1982	Custom, Scottsdale, Silverado	US5030
5.7L V8 350 CID	1969-1972		US898	4.8L L6 292 CID	1983	Custom, Silverado	US5030
5.7L V8 350 CID	1969-1972	High performance	US898H	4.8L L6 292 CID	1984	Custom, Scottsdale	US5030
5.7L V8 5704cc 348 CID	1960-1961		US898	4.8L L6 292 CID	1985-1986	Custom, Scottsdale, Silverado	US5030
5.7L V8 5704cc 348 CID	1960-1961	High performance	US898H	5.0L V8 305 CID	1977-1978		US1121
5.7L V8 5736cc 350 CID	1969-1972		US898	5.0L V8 305 CID	1977-1978	High performance	US1121H
5.7L V8 5736cc 350 CID	1969-1972	High performance	US898H	5.0L V8 305 CID	1980	Cheyenne, Custom Deluxe, Scottsdale, Silverado	US1121
6.5L V8 396 CID	1968-1969		US981	5.0L V8 305 CID	1980	Cheyenne, Custom Deluxe, Scottsdale, Silverado; High performance	US1121H
6.5L V8 6489cc 396 CID	1968-1969		US981	5.0L V8 305 CID	1985	Custom, Scottsdale, Silverado	US1121
6.6L V8 6588cc 402 CID	1970-1972		US981	5.0L V8 305 CID	1985	Custom, Scottsdale, Silverado; High performance	US1121H
<b>K10 SUBURBAN</b>				5.0L V8 305 CID	1985	Custom, Scottsdale, Silverado; High performance	US1121H
4.1L L6 250 CID	1975-1977		US1110	5.7L V8 350 CID	1975-1976		US1109
4.1L L6 250 CID	1978-1979		US1107	5.7L V8 350 CID	1975-1976	High performance	US1109H
4.1L L6 250 CID	1980	Custom Deluxe, Scottsdale, Silverado	US1107	5.7L V8 350 CID	1977-1979		US1121
4.6L V8 4638cc 283 CID	1967		US898	5.7L V8 350 CID	1977-1979	High performance	US1121H
4.6L V8 4638cc 283 CID	1967	High performance	US898H	5.7L V8 350 CID	1980	Cheyenne, Custom Deluxe, Scottsdale, Silverado	US1121
4.8L L6 292 CID	1969-1970		US896	5.7L V8 350 CID	1980	Cheyenne, Custom Deluxe, Scottsdale, Silverado; High performance	US1121H
4.8L L6 4801cc 292 CID	1967		US896	5.7L V8 350 CID	1981	Custom, Deluxe	US1121
5.0L L6 305 CID	1977-1979		US1121	5.7L V8 350 CID	1981	Custom, Deluxe; High performance	US1121H
5.0L V8 305 CID	1977-1979	High performance	US1121H	5.7L V8 350 CID	1981	Custom, Scottsdale, Silverado	US1121
5.0L V8 305 CID	1980	Custom Deluxe, Scottsdale, Silverado	US1121	5.7L V8 350 CID	1982	Custom, Scottsdale, Silverado; High performance	US1121H
5.0L V8 305 CID	1980	Custom Deluxe, Scottsdale, Silverado; High performance	US1121H	5.7L V8 350 CID	1982	Custom, Scottsdale, Silverado; High performance	US1121H
5.0L V8 305 CID	1981	Custom, Deluxe	US1121	5.7L V8 350 CID	1983	Custom, Silverado	US1121
5.0L V8 305 CID	1981	Custom, Deluxe; High performance	US1121H	5.7L V8 350 CID	1983	Custom, Silverado; High performance	US1121H
5.0L V8 305 CID	1982	Custom, Scottsdale, Silverado	US1121	5.7L V8 350 CID	1984	Custom, Scottsdale	US1121
5.0L V8 305 CID	1982	Custom, Scottsdale, Silverado; High performance	US1121H	5.7L V8 350 CID	1984	Custom, Scottsdale; High performance	US1121H
5.0L V8 305 CID	1983	Custom, Silverado	US1121	5.7L V8 350 CID	1985-1986	Custom, Scottsdale, Silverado	US1121
5.0L V8 305 CID	1983	Custom, Silverado; High performance	US1121H	5.7L V8 350 CID	1985-1986	Custom, Scottsdale, Silverado; High performance	US1121H
5.0L V8 305 CID	1984	Custom	US1121	6.2L V8 379 CID	1982	Custom, Scottsdale, Silverado	US5008
5.0L V8 305 CID	1984	Custom; High performance	US1121H	6.2L V8 379 CID	1983	Custom, Silverado	US5008
5.0L V8 305 CID	1985-1986	Custom, Scottsdale, Silverado	US1121	6.2L V8 379 CID	1984	Custom, Scottsdale	US5008
5.0L V8 305 CID	1985-1986	Custom, Scottsdale, Silverado; High performance	US1121H	6.2L V8 379 CID	1985-1986	Custom, Scottsdale, Silverado	US5008
5.0L V8 307 CID	1968-1972		US898	6.6L V8 400 CID	1975-1976		US1109
5.0L V8 307 CID	1968-1972	High performance	US898H	6.6L V8 400 CID	1975-1976	High performance	US1109H
5.0L V8 5031cc 307 CID	1968-1972		US898	6.6L V8 400 CID	1977-1979		US1121
5.0L V8 5031cc 307 CID	1968-1972	High performance	US898H	6.6L V8 400 CID	1977-1979	High performance	US1121H
5.3L V8 5358cc 327 CID	1967-1969		US898	6.6L V8 400 CID	1980	Cheyenne, Custom Deluxe, Scottsdale, Silverado	US1121
5.3L V8 5358cc 327 CID	1967-1969	High performance	US898H	6.6L V8 400 CID	1980	Cheyenne, Custom Deluxe, Scottsdale, Silverado; High performance	US1121H
5.4L V8 327 CID	1968		US898	7.4L V8 454 CID	1980	Cheyenne, Custom Deluxe, Scottsdale, Silverado	US1002
5.4L V8 327 CID	1968	High performance	US898H	7.4L V8 454 CID	1980	Cheyenne, Custom Deluxe, Scottsdale, Silverado; High performance	US1002H
5.7L V8 350 CID	1969-1972		US898	<b>K20 PANEL</b>			
5.7L V8 350 CID	1969-1972	High performance	US898H	4.6L V8 283 CID	1967		US898
5.7L V8 350 CID	1975-1976		US1109	4.6L V8 283 CID	1967	High performance	US898H
5.7L V8 350 CID	1975-1976	High performance	US1109H	5.4L V8 327 CID	1967		US898
5.7L V8 350 CID	1977-1979		US1121	5.4L V8 327 CID	1967	High performance	US898H
5.7L V8 350 CID	1977-1979	High performance	US1121H	<b>K20 PICKUP</b>			
5.7L V8 350 CID	1980	Custom Deluxe, Scottsdale, Silverado	US1121	4.3L L6 4278cc 261 CID	1961-1962		US898
5.7L V8 350 CID	1980	Custom Deluxe, Scottsdale, Silverado; High performance	US1121H	4.3L L6 4278cc 261 CID	1961-1962	High performance	US898H
5.7L V8 350 CID	1981	Custom, Deluxe	US1121	4.6L V8 4638cc 283 CID	1960-1967		US898
5.7L V8 350 CID	1981	Custom, Deluxe; High performance	US1121H	4.6L V8 4638cc 283 CID	1960-1967	High performance	US898H
5.7L V8 350 CID	1982	Custom, Scottsdale, Silverado	US1121	4.8L L6 292 CID	1969-1974		US896
5.7L V8 350 CID	1982	Custom, Scottsdale, Silverado; High performance	US1121H	4.8L L6 4786cc 292 CID	1972-1974		US896
5.7L V8 350 CID	1983	Custom, Silverado	US1121	4.8L L6 4801cc 292 CID	1965-1974		US896
5.7L V8 350 CID	1983	Custom, Silverado; High performance	US1121H	5.0L V8 307 CID	1968-1972		US898
5.7L V8 350 CID	1984	Custom, Scottsdale	US1121	5.0L V8 307 CID	1968-1972	High performance	US898H
5.7L V8 350 CID	1984	Custom, Scottsdale; High performance	US1121H	5.0L V8 5031cc 307 CID	1968-1972		US898
5.7L V8 350 CID	1985-1986	Custom, Scottsdale, Silverado	US1121	5.0L V8 5031cc 307 CID	1968-1972	High performance	US898H
5.7L V8 350 CID	1985-1986	Custom, Scottsdale, Silverado; High performance	US1121H	5.3L V8 5358cc 327 CID	1966-1969		US898
5.7L V8 5736cc 350 CID	1969-1972		US898	5.3L V8 5358cc 327 CID	1966-1969	High performance	US898H
5.7L V8 5736cc 350 CID	1969-1972	High performance	US898H	5.4L V8 327 CID	1968		US898
6.2L V8 379 CID	1982	Custom, Scottsdale, Silverado	US5008	5.4L V8 327 CID	1968	High performance	US898H
6.2L V8 379 CID	1983	Custom, Silverado	US5008	5.7L V8 350 CID	1969-1972		US898
6.2L V8 379 CID	1984	Custom, Scottsdale	US5008	5.7L V8 350 CID	1969-1972	High performance	US898H
6.2L V8 379 CID	1985-1986	Custom, Scottsdale, Silverado	US5008	5.7L V8 5704cc 348 CID	1960-1961		US898
6.5L V8 396 CID	1968-1969		US981				
6.5L V8 6489cc 396 CID	1968-1969		US981				
6.6L V8 400 CID	1975-1976		US1109				
6.6L V8 400 CID	1975-1976	High performance	US1109H				
6.6L V8 400 CID	1977-1979		US1121				
6.6L V8 400 CID	1977-1979	High performance	US1121H				

WATER PUMPS



Engine	Years	Application Description	USMW	Engine	Years	Application Description	USMW
<b>CHEVROLET (cont'd.)</b>				<b>CHEVROLET (cont'd.)</b>			
<b>K20 PICKUP (cont'd.)</b>				<b>K30 (cont'd.)</b>			
5.7L V8 5704cc 348 CID	1960-1961	High performance	<b>US898H</b>	5.7L V8 350 CID	1982	Custom, Scottsdale, Silverado	<b>US1121</b>
5.7L V8 5736cc 350 CID	1969-1972		<b>US898</b>	5.7L V8 350 CID	1982	Custom, Scottsdale, Silverado; High performance	<b>US1121H</b>
5.7L V8 5736cc 350 CID	1969-1972	High performance	<b>US898H</b>	5.7L V8 350 CID	1983	Custom, Silverado	<b>US1121</b>
6.5L V8 396 CID	1968-1969		<b>US981</b>	5.7L V8 350 CID	1983	Custom, Silverado; High performance	<b>US1121H</b>
6.5L V8 6489cc 396 CID	1968-1969		<b>US981</b>	5.7L V8 350 CID	1984	Custom, Scottsdale	<b>US1121</b>
6.6L V8 6588cc 402 CID	1970-1972		<b>US981</b>	5.7L V8 350 CID	1984	Custom, Scottsdale; High performance	<b>US1121H</b>
<b>K20 SUBURBAN</b>				5.7L V8 350 CID	1985-1986	Custom, Scottsdale, Silverado	<b>US1121</b>
4.6L V8 4638cc 283 CID	1967		<b>US898</b>	5.7L V8 350 CID	1985-1986	Custom, Scottsdale, Silverado; High performance	<b>US1121H</b>
4.6L V8 4638cc 283 CID	1967	High performance	<b>US898H</b>	6.2L V8 379 CID	1982	Custom, Scottsdale, Silverado	<b>US5008</b>
4.8L L6 292 CID	1968-1974		<b>US896</b>	6.2L V8 379 CID	1983	Custom, Silverado	<b>US5008</b>
4.8L L6 292 CID	1975-1977		<b>US1137</b>	6.2L V8 379 CID	1984	Custom, Scottsdale	<b>US5008</b>
4.8L L6 292 CID	1975-1977	High performance	<b>US1137H</b>	6.2L V8 379 CID	1985-1986	Custom, Scottsdale, Silverado	<b>US5008</b>
4.8L L6 292 CID	1978-1979		<b>US5030</b>	6.6L V8 400 CID	1977-1979	High performance	<b>US1121H</b>
4.8L L6 292 CID	1980	Custom Deluxe, Scottsdale, Silverado	<b>US5030</b>	6.6L V8 400 CID	1980	Cheyenne, Custom Deluxe, Scottsdale, Silverado	<b>US1121</b>
4.8L L6 292 CID	1981	Custom, Deluxe	<b>US5030</b>	6.6L V8 400 CID	1980	Cheyenne, Custom Deluxe, Scottsdale, Silverado; High performance	<b>US1121H</b>
4.8L L6 292 CID	1982	Custom, Scottsdale, Silverado	<b>US5030</b>	7.4L V8 454 CID	1980	Cheyenne, Custom Deluxe, Scottsdale, Silverado	<b>US1002</b>
4.8L L6 4786cc 292 CID	1973-1974		<b>US896</b>	7.4L V8 454 CID	1980	Cheyenne, Custom Deluxe, Scottsdale, Silverado; High performance	<b>US1002H</b>
4.8L L6 4801cc 292 CID	1967-1974		<b>US896</b>	7.4L V8 454 CID	1981	Custom, Deluxe	<b>US1002</b>
5.0L V8 305 CID	1977-1978		<b>US1121</b>	7.4L V8 454 CID	1981	Custom, Deluxe; High performance	<b>US1002H</b>
5.0L V8 305 CID	1977-1978	High performance	<b>US1121H</b>	7.4L V8 454 CID	1982	Custom, Scottsdale, Silverado	<b>US1002</b>
5.0L V8 305 CID	1985-1986	Custom, Scottsdale, Silverado	<b>US1121</b>	7.4L V8 454 CID	1982	Custom, Scottsdale, Silverado; High performance	<b>US1002H</b>
5.0L V8 305 CID	1985-1986	Custom, Scottsdale, Silverado; High performance	<b>US1121H</b>	7.4L V8 454 CID	1983	Custom, Silverado	<b>US1002</b>
5.0L V8 307 CID	1968-1972		<b>US898</b>	7.4L V8 454 CID	1983	Custom, Silverado; High performance	<b>US1002H</b>
5.0L V8 307 CID	1968-1972	High performance	<b>US898H</b>	7.4L V8 454 CID	1984	Custom, Scottsdale	<b>US1002</b>
5.0L V8 5031cc 307 CID	1968-1972		<b>US898</b>	7.4L V8 454 CID	1984	Custom, Scottsdale; High performance	<b>US1002H</b>
5.0L V8 5031cc 307 CID	1968-1972	High performance	<b>US898H</b>	7.4L V8 454 CID	1985-1986	Custom, Scottsdale, Silverado	<b>US1002</b>
5.3L V8 5358cc 327 CID	1967-1969		<b>US898</b>	7.4L V8 454 CID	1985-1986	Custom, Scottsdale, Silverado; High performance	<b>US1002H</b>
5.3L V8 5358cc 327 CID	1967-1969	High performance	<b>US898H</b>				
5.4L V8 327 CID	1968		<b>US898</b>	<b>K30 PICKUP</b>			
5.4L V8 327 CID	1968	High performance	<b>US898H</b>	4.8L L6 292 CID	1968-1974		<b>US896</b>
5.7L V8 350 CID	1969-1972		<b>US898</b>	4.8L L6 4786cc 292 CID	1973-1974		<b>US896</b>
5.7L V8 350 CID	1969-1972	High performance	<b>US898H</b>	4.8L L6 4801cc 292 CID	1968-1974		<b>US896</b>
5.7L V8 350 CID	1975-1976		<b>US1109</b>	5.0L V8 307 CID	1968-1972		<b>US898</b>
5.7L V8 350 CID	1975-1976	High performance	<b>US1109H</b>	5.0L V8 307 CID	1968-1972	High performance	<b>US898H</b>
5.7L V8 350 CID	1977-1979		<b>US1121</b>	5.0L V8 5031cc 307 CID	1968-1972		<b>US898</b>
5.7L V8 350 CID	1977-1979	High performance	<b>US1121H</b>	5.0L V8 5031cc 307 CID	1968-1972	High performance	<b>US898H</b>
5.7L V8 350 CID	1980	Custom Deluxe, Scottsdale, Silverado	<b>US1121</b>	5.3L V8 5358cc 327 CID	1968-1969		<b>US898</b>
5.7L V8 350 CID	1980	Custom Deluxe, Scottsdale, Silverado; High performance	<b>US1121H</b>	5.3L V8 5358cc 327 CID	1968-1969	High performance	<b>US898H</b>
5.7L V8 350 CID	1981	Custom, Deluxe	<b>US1121</b>	5.4L V8 327 CID	1968		<b>US898</b>
5.7L V8 350 CID	1981	Custom, Deluxe; High performance	<b>US1121H</b>	5.4L V8 327 CID	1968	High performance	<b>US898H</b>
5.7L V8 350 CID	1982	Custom, Scottsdale, Silverado	<b>US1121</b>	5.7L V8 350 CID	1969-1972		<b>US898</b>
5.7L V8 350 CID	1982	Custom, Scottsdale, Silverado; High performance	<b>US1121H</b>	5.7L V8 350 CID	1969-1972	High performance	<b>US898H</b>
5.7L V8 350 CID	1983	Custom, Silverado	<b>US1121</b>	5.7L V8 5736cc 350 CID	1969-1972		<b>US898</b>
5.7L V8 350 CID	1983	Custom, Silverado; High performance	<b>US1121H</b>	5.7L V8 5736cc 350 CID	1969-1972	High performance	<b>US898H</b>
5.7L V8 350 CID	1984	Custom, Scottsdale	<b>US1121</b>	6.5L V8 396 CID	1968-1969		<b>US981</b>
5.7L V8 350 CID	1984	Custom, Scottsdale; High performance	<b>US1121H</b>	6.5L V8 6489cc 396 CID	1968-1969		<b>US981</b>
5.7L V8 350 CID	1985-1986	Custom, Scottsdale, Silverado	<b>US1121</b>	6.6L V8 402 CID	1970-1971		<b>US981</b>
5.7L V8 350 CID	1985-1986	Custom, Scottsdale, Silverado; High performance	<b>US1121H</b>	6.6L V8 6588cc 402 CID	1970-1972		<b>US981</b>
5.7L V8 5736cc 350 CID	1969-1972		<b>US898</b>	<b>K1500</b>			
5.7L V8 5736cc 350 CID	1969-1972	High performance	<b>US898H</b>	4.3L V6 262 CID	1988-1989	Cheyenne, Scottsdale, Silverado	<b>US5049</b>
6.2L V8 379 CID	1982	Custom, Scottsdale, Silverado	<b>US5008</b>	4.3L V6 262 CID	1988-1989	Cheyenne, Scottsdale, Silverado; High performance	<b>US5049H</b>
6.2L V8 379 CID	1983	Custom, Silverado	<b>US5008</b>	4.3L V6 262 CID	1990	Cheyenne, Scottsdale, Silverado, WT	<b>US5049</b>
6.2L V8 379 CID	1984	Custom, Scottsdale	<b>US5008</b>	4.3L V6 262 CID	1990	Cheyenne, Scottsdale, Silverado, WT; High performance	<b>US5049H</b>
6.2L V8 379 CID	1985-1986	Custom, Scottsdale, Silverado	<b>US5008</b>	4.3L V6 262 CID	1991	Cheyenne, Scottsdale, Silverado, Sport, WT	<b>US5049</b>
6.5L V8 6489cc 396 CID	1968-1969		<b>US981</b>	4.3L V6 262 CID	1991	Cheyenne, Scottsdale, Silverado, Sport, WT; High performance	<b>US5049H</b>
6.6L V8 400 CID	1975-1976		<b>US1109</b>	4.3L V6 262 CID	1992	Cheyenne, Scottsdale, Silverado, WT	<b>US5049</b>
6.6L V8 400 CID	1975-1976	High performance	<b>US1109H</b>	4.3L V6 262 CID	1992	Cheyenne, Scottsdale, Silverado, WT; High performance	<b>US5049H</b>
6.6L V8 400 CID	1977-1979		<b>US1121</b>	4.3L V6 262 CID	1993	Cheyenne, Silverado, WT	<b>US5049</b>
6.6L V8 400 CID	1977-1979	High performance	<b>US1121H</b>	4.3L V6 262 CID	1993	Cheyenne, Silverado, WT; High performance	<b>US5049H</b>
6.6L V8 400 CID	1980	Custom Deluxe, Scottsdale, Silverado	<b>US1121</b>	4.3L V6 262 CID	1994-1995	Base, Cheyenne, Silverado, WT	<b>US5049</b>
6.6L V8 400 CID	1980	Custom Deluxe, Scottsdale, Silverado; High performance	<b>US1121H</b>	4.3L V6 262 CID	1994-1995	Base, Cheyenne, Silverado, WT; High performance	<b>US5049H</b>
6.6L V8 400 CID	1980		<b>US981</b>	4.3L V6 262 CID	1996-1997	Base, Cheyenne, Silverado, WT	<b>US5077</b>
6.6L V8 6588cc 402 CID	1970-1972		<b>US981</b>	4.3L V6 262 CID	1996-1997	Base, Cheyenne, Silverado, WT; High performance	<b>US5077H</b>
7.4L V8 454 CID	1985	Custom, Scottsdale, Silverado	<b>US1002</b>	4.3L V6 262 CID	1998	Cheyenne, Silverado, WT	<b>US5077</b>
7.4L V8 454 CID	1985	Custom, Scottsdale, Silverado; High performance	<b>US1002H</b>	4.3L V6 262 CID	1998	Cheyenne, Silverado, WT; High performance	<b>US5077H</b>
<b>K30</b>				5.0L V8 305 CID	1988-1989	Cheyenne, Scottsdale, Silverado	<b>US5049</b>
4.8L L6 292 CID	1977-1979		<b>US5030</b>	5.0L V8 305 CID	1988-1989	Cheyenne, Scottsdale, Silverado; High performance	<b>US5049H</b>
4.8L L6 292 CID	1980	Cheyenne, Custom Deluxe, Scottsdale, Silverado	<b>US5030</b>	5.0L V8 305 CID	1990	Cheyenne, Scottsdale, Silverado, WT	<b>US5049</b>
4.8L L6 292 CID	1981	Custom, Deluxe	<b>US5030</b>	5.0L V8 305 CID	1990	Cheyenne, Scottsdale, Silverado, WT; High performance	<b>US5049H</b>
4.8L L6 292 CID	1982	Custom, Scottsdale, Silverado	<b>US5030</b>				
4.8L L6 292 CID	1983	Custom, Silverado	<b>US5030</b>				
4.8L L6 292 CID	1984	Custom, Scottsdale	<b>US5030</b>				
4.8L L6 292 CID	1985-1986	Custom, Scottsdale, Silverado	<b>US5030</b>				
5.7L V8 350 CID	1977-1979		<b>US1121</b>				
5.7L V8 350 CID	1977-1979	High performance	<b>US1121H</b>				
5.7L V8 350 CID	1980	Cheyenne, Custom Deluxe, Scottsdale, Silverado	<b>US1121</b>				
5.7L V8 350 CID	1980	Cheyenne, Custom Deluxe, Scottsdale, Silverado; High performance	<b>US1121H</b>				
5.7L V8 350 CID	1981	Custom, Deluxe	<b>US1121</b>				
5.7L V8 350 CID	1981	Custom, Deluxe; High performance	<b>US1121H</b>				



Engine	Years	Application Description	USMW	Engine	Years	Application Description	USMW
<b>CHEVROLET (cont'd.)</b>				<b>CHEVROLET (cont'd.)</b>			
<b>K1500 (cont'd.)</b>				<b>K2500 (cont'd.)</b>			
5.0L V8 305 CID	1991	Cheyenne, Scottsdale, Silverado, Sport, WT	US5049	4.3L V6 262 CID	1994-1995	Base, Cheyenne, Silverado, WT; High performance	US5049H
5.0L V8 305 CID	1991	Cheyenne, Scottsdale, Silverado, Sport, WT; High performance	US5049H	5.0L V8 305 CID	1988-1992	Cheyenne, Scottsdale, Silverado	US5049
5.0L V8 305 CID	1992	Cheyenne, Scottsdale, Silverado, WT	US5049	5.0L V8 305 CID	1988-1992	Cheyenne, Scottsdale, Silverado; High performance	US5049H
5.0L V8 305 CID	1992	Cheyenne, Scottsdale, Silverado, WT; High performance	US5049H	5.0L V8 305 CID	1993	Cheyenne, Silverado	US5049
5.0L V8 305 CID	1993	Cheyenne, Silverado, WT	US5049	5.0L V8 305 CID	1993	Cheyenne, Silverado; High performance	US5049H
5.0L V8 305 CID	1993	Cheyenne, Silverado, WT; High performance	US5049H	5.0L V8 305 CID	1994-1995	Base, Cheyenne, Silverado, WT	US5049
5.0L V8 305 CID	1994-1995	Base, Cheyenne, Silverado, WT	US5049	5.0L V8 305 CID	1994-1995	Base, Cheyenne, Silverado, WT; High performance	US5049H
5.0L V8 305 CID	1994-1995	Base, Cheyenne, Silverado, WT; High performance	US5049H	5.0L V8 305 CID	1998	Cheyenne, Silverado, WT	US5077
5.0L V8 305 CID	1996-1997	Base, Cheyenne, Silverado, WT	US5077	5.0L V8 305 CID	1998	Cheyenne, Silverado, WT; High performance	US5077H
5.0L V8 305 CID	1996-1997	Base, Cheyenne, Silverado, WT; High performance	US5077H	5.7L V8 350 CID	1988-1992	Cheyenne, Scottsdale, Silverado	US5049
5.0L V8 305 CID	1998	Cheyenne, Silverado, WT	US5077	5.7L V8 350 CID	1988-1992	Cheyenne, Scottsdale, Silverado; High performance	US5049H
5.0L V8 305 CID	1998	Cheyenne, Silverado, WT; High performance	US5077H	5.7L V8 350 CID	1993	Cheyenne, Silverado	US5049
5.0L V8 305 CID	1999	LS	US5077	5.7L V8 350 CID	1993	Cheyenne, Silverado; High performance	US5049H
5.0L V8 305 CID	1999	LS; High performance	US5077H	5.7L V8 350 CID	1994-1995	Base, Cheyenne, Silverado, WT	US5049
5.7L V8 350 CID	1988-1989	Cheyenne, Scottsdale, Silverado	US5049	5.7L V8 350 CID	1994-1995	Base, Cheyenne, Silverado, WT; High performance	US5049H
5.7L V8 350 CID	1988-1989	Cheyenne, Scottsdale, Silverado; High performance	US5049H	5.7L V8 350 CID	1996-1997	Base, Cheyenne, Silverado	US5077
5.7L V8 350 CID	1990	Cheyenne, Scottsdale, Silverado, WT	US5049	5.7L V8 350 CID	1996-1997	Base, Cheyenne, Silverado; High performance	US5077H
5.7L V8 350 CID	1990	Cheyenne, Scottsdale, Silverado, WT; High performance	US5049H	5.7L V8 350 CID	1998	Cheyenne, Silverado, WT	US5077
5.7L V8 350 CID	1991	Cheyenne, Scottsdale, Silverado, Sport, WT	US5049	5.7L V8 350 CID	1998	Cheyenne, Silverado, WT; High performance	US5077H
5.7L V8 350 CID	1991	Cheyenne, Scottsdale, Silverado, Sport, WT; High performance	US5049H	5.7L V8 350 CID	1999-2000	Base, LS	US5077
5.7L V8 350 CID	1992	Cheyenne, Scottsdale, Silverado, WT	US5049	5.7L V8 350 CID	1999-2000	Base, LS; High performance	US5077H
5.7L V8 350 CID	1992	Cheyenne, Scottsdale, Silverado, WT; High performance	US5049H	5.7L V8 5737cc 350 CID	2000	Mexican Application	US5077
5.7L V8 350 CID	1993	Cheyenne, Silverado, WT	US5049	6.2L V8 379 CID	1988-1992	Cheyenne, Scottsdale, Silverado	US5062
5.7L V8 350 CID	1993	Cheyenne, Silverado, WT; High performance	US5049H	6.2L V8 379 CID	1993	Cheyenne, Silverado	US5062
5.7L V8 350 CID	1994-1995	Base, Cheyenne, Silverado, WT	US5049	6.5L V8 395 CID	1992-1993	Cheyenne, Silverado	US5062
5.7L V8 350 CID	1994-1995	Base, Cheyenne, Silverado, WT; High performance	US5049H	6.5L V8 395 CID	1994-1995	Base, Cheyenne, Silverado, WT	US5062
5.7L V8 350 CID	1996-1997	Base, Cheyenne, Silverado, WT	US5077	6.5L V8 395 CID	1996	Base, Cheyenne, Silverado; 1st Design, Single Thermostat	US5062
5.7L V8 350 CID	1996-1997	Base, Cheyenne, Silverado, WT; High performance	US5077H	6.5L V8 395 CID	1996	Base, Cheyenne, Silverado; 2nd Design, Dual Thermostat	US5074
5.7L V8 350 CID	1998	Cheyenne, Silverado, WT	US5077	6.5L V8 395 CID	1997	Base, Cheyenne, Silverado	US5074
5.7L V8 350 CID	1998	Cheyenne, Silverado, WT; High performance	US5077H	6.5L V8 395 CID	1998	Cheyenne, Silverado, WT	US5074
5.7L V8 350 CID	1999	LS	US5077	6.5L V8 395 CID	1999	Base, LS; Bolt on pulley	US5074
5.7L V8 350 CID	1999	LS; High performance	US5077H	6.5L V8 395 CID	1999-2000	Base, LS	US5086
5.7L V8 5737cc 350 CID	2000	Mexican Application	US5077	7.4L V8 454 CID	1991-1993	Cheyenne, Silverado	US5038
6.2L V8 379 CID	1988-1989	Cheyenne, Scottsdale, Silverado	US5062	7.4L V8 454 CID	1991-1993	Cheyenne, Silverado; High performance	US5038H
6.2L V8 379 CID	1990	Cheyenne, Scottsdale, Silverado, WT	US5062	7.4L V8 454 CID	1994-1995	Base, Cheyenne, Silverado, WT	US5038
6.2L V8 379 CID	1991	Cheyenne, Scottsdale, Silverado, Sport, WT	US5062	7.4L V8 454 CID	1994-1995	Base, Cheyenne, Silverado, WT; High performance	US5038H
6.2L V8 379 CID	1992	Cheyenne, Scottsdale, Silverado, WT	US5062	7.4L V8 454 CID	1996-1997	Base, Cheyenne, Silverado	US5038
6.2L V8 379 CID	1993	Cheyenne, Silverado, WT	US5062	7.4L V8 454 CID	1996-1997	Base, Cheyenne, Silverado; High performance	US5038H
6.5L V8 395 CID	1994-1995	Base, Cheyenne, Silverado, WT	US5062	7.4L V8 454 CID	1998	Cheyenne, Silverado, WT	US5038
6.5L V8 395 CID	1996	Base, Cheyenne, Silverado, WT; Early	US5062	7.4L V8 454 CID	1998	Cheyenne, Silverado, WT; High performance	US5038H
6.5L V8 395 CID	1996	Base, Cheyenne, Silverado, WT; Late	US5074	7.4L V8 454 CID	1999-2000	Base, LS	US5038
6.5L V8 395 CID	1997	Base, Cheyenne, Silverado, WT	US5074	7.4L V8 454 CID	1999-2000	Base, LS; High performance	US5038H
6.5L V8 395 CID	1998	Cheyenne, Silverado, WT	US5074	<b>K2500 SUBURBAN</b>			
<b>K1500 SUBURBAN</b>				5.7L V8 350 CID	1992	Base, Silverado; 6.9" HUB HEIGHT	US5049
5.7L V8 350 CID	1992	Base, Silverado; 6.9" HUB HEIGHT	US5049	5.7L V8 350 CID	1992	Base, Silverado; 6.9" HUB HEIGHT, High performance	US5049H
5.7L V8 350 CID	1992	Base, Silverado; 6.9" HUB HEIGHT, High performance	US5049H	5.7L V8 350 CID	1992	Base, Silverado; 5.8" HUB HEIGHT	US5073
5.7L V8 350 CID	1992	Base, Silverado; 5.8" HUB HEIGHT	US5073	5.7L V8 350 CID	1993-1994	Base, Silverado	US5049
5.7L V8 350 CID	1993-1994	Base, Silverado	US5049	5.7L V8 350 CID	1993-1994	Base, Silverado	US5049H
5.7L V8 350 CID	1993-1994	Base, Silverado; High performance	US5049H	5.7L V8 350 CID	1995	Base, LS, LT	US5049
5.7L V8 350 CID	1995	Base, LS, LT	US5049	5.7L V8 350 CID	1995	Base, LS, LT; High performance	US5049H
5.7L V8 350 CID	1995	Base, LS, LT; High performance	US5049H	5.7L V8 350 CID	1996-1997	Base, LS, LT	US5077
5.7L V8 350 CID	1996-1997	Base, LS, LT	US5077	5.7L V8 350 CID	1996-1997	Base, LS, LT; High performance	US5077H
5.7L V8 350 CID	1996-1997	Base, LS, LT; High performance	US5077H	5.7L V8 350 CID	1998-1999	Base, LS	US5077
5.7L V8 350 CID	1998	Base, LS	US5077	5.7L V8 350 CID	1998-1999	Base, LS; High performance	US5077H
5.7L V8 350 CID	1998-1999	Base, LS; High performance	US5077H	6.5L V8 395 CID	1994	Base, Silverado	US5062
5.7L V8 350 CID	1999	Base, LS, LT	US5077	6.5L V8 395 CID	1995	Base, LS, LT	US5062
6.5L V8 395 CID	1995	Base, LS, LT	US5062	6.5L V8 395 CID	1996	Base, LS, LT; Early	US5062
6.5L V8 395 CID	1996	Base, LS, LT; Early	US5062	6.5L V8 395 CID	1996	Base, LS, LT; Late	US5074
6.5L V8 395 CID	1996	Base, LS, LT; Late	US5074	6.5L V8 395 CID	1997	Base, LS, LT	US5074
6.5L V8 395 CID	1997	Base, LS, LT	US5074	6.5L V8 395 CID	1998	Base, LS	US5074
6.5L V8 395 CID	1998	Base, LS	US5074	6.5L V8 395 CID	1999	Base, LS; Bolt on pulley	US5074
6.5L V8 395 CID	1999	Base, LS, LT; Bolt on pulley	US5074	6.5L V8 395 CID	1999	Base, LS	US5086
6.5L V8 395 CID	1999	Base, LS, LT	US5086	7.4L V8 454 CID	1992-1994	Base, Silverado	US5038
<b>K2500</b>				7.4L V8 454 CID	1992-1994	Base, Silverado; High performance	US5038H
4.3L V6 262 CID	1988-1992	Cheyenne, Scottsdale, Silverado	US5049	7.4L V8 454 CID	1995-1997	Base, LS, LT	US5038
4.3L V6 262 CID	1988-1992	Cheyenne, Scottsdale, Silverado; High performance	US5049H	7.4L V8 454 CID	1995-1997	Base, LS, LT; High performance	US5038H
4.3L V6 262 CID	1993	Cheyenne, Silverado	US5049	7.4L V8 454 CID	1998-1999	Base, LS	US5038
4.3L V6 262 CID	1993	Cheyenne, Silverado; High performance	US5049H	7.4L V8 454 CID	1998-1999	Base, LS; High performance	US5038H
4.3L V6 262 CID	1994-1995	Base, Cheyenne, Silverado, WT	US5049	<b>K3500</b>			
				5.7L V8 350 CID	1988-1992	Cheyenne, Scottsdale, Silverado	US5049
				5.7L V8 350 CID	1988-1992	Cheyenne, Scottsdale, Silverado; High performance	US5049H

WATER PUMPS

Engine	Years	Application Description	USMW	Engine	Years	Application Description	USMW
<b>CHEVROLET (cont'd.)</b>				<b>CHEVROLET (cont'd.)</b>			
<b>K3500 (cont'd.)</b>				<b>LUV PICKUP</b>			
5.7L V8 350 CID	1993	Cheyenne, Silverado	<b>US5049</b>	1.8L L4 111 CID	1972-1974		<b>US1046</b>
5.7L V8 350 CID	1993	Cheyenne, Silverado; High performance	<b>US5049H</b>	<b>MALIBU</b>			
5.7L V8 350 CID	1994-1995	Base, Cheyenne, Silverado	<b>US5049</b>	1.5L L4 1490cc 91 CID	2016-2017	L, LS, LT; Pump only	<b>US8147</b>
5.7L V8 350 CID	1994-1995	Base, Cheyenne, Silverado; High performance	<b>US5049H</b>	1.5L L4 1490cc 91 CID	2017	L, LS, LT	<b>US8147</b>
5.7L V8 350 CID	1996-1997	Base, Cheyenne, Silverado	<b>US5077</b>	1.8L L4 1796cc 110 CID	2016-2017	Hybrid	<b>US8155</b>
5.7L V8 350 CID	1996-1997	Base, Cheyenne, Silverado; High performance	<b>US5077H</b>	1.8L L4 1796cc 110 CID	2016-2017	Hybrid; Pump only	<b>US8155</b>
5.7L V8 350 CID	1998	Cheyenne, Silverado	<b>US5077</b>	2.0L L4 1998cc 122 CID	2013-2015	LT, LTZ; Pump only	<b>US8102</b>
5.7L V8 350 CID	1998	Cheyenne, Silverado; High performance	<b>US5077H</b>	2.0L L4 1998cc 122 CID	2015	LT, LTZ	<b>US8102</b>
5.7L V8 350 CID	1999-2000	Base, LS	<b>US5077</b>	2.0L L4 1998cc 122 CID	2016	LT, Premier	<b>US8102</b>
5.7L V8 350 CID	1999-2000	Base, LS; High performance	<b>US5077H</b>	2.0L L4 1998cc 122 CID	2017	Premier	<b>US8102</b>
6.2L V8 379 CID	1988-1992	Cheyenne, Scottsdale, Silverado	<b>US5062</b>	2.2L L4 2198cc 134 CID	2004-2005	Base	<b>US5092</b>
6.2L V8 379 CID	1993	Cheyenne, Silverado	<b>US5062</b>	2.2L L4 2198cc 134 CID	2006-2007	LS, LT	<b>US5092</b>
6.5L V8 395 CID	1992	Cheyenne, Scottsdale, Silverado	<b>US5062</b>	2.2L L4 2198cc 134 CID	2008	Classic LS	<b>US5092</b>
6.5L V8 395 CID	1993	Cheyenne, Silverado	<b>US5062</b>	2.4L L4 2384cc 145 CID	2008-2010	Hybrid, LS, LT, LTZ	<b>US5092</b>
6.5L V8 395 CID	1994-1995	Base, Cheyenne, Silverado	<b>US5062</b>	2.4L L4 2384cc 145 CID	2011-2012	LS, LT, LTZ	<b>US5092</b>
6.5L V8 395 CID	1996	Base, Cheyenne, Silverado; 1st Design, Single Thermostat	<b>US5062</b>	2.4L L4 2384cc 145 CID	2013-2014	Eco	<b>US5092</b>
6.5L V8 395 CID	1996	Base, Cheyenne, Silverado; 2nd Design, Dual Thermostat	<b>US5074</b>	2.4L L4 2392cc 146 CID	1997-1999	Base	<b>US5076</b>
6.5L V8 395 CID	1997	Base, Cheyenne, Silverado	<b>US5074</b>	2.4L L4 2395cc 146 CID	2000-2001	Mexican Application	<b>US5076</b>
6.5L V8 395 CID	1998	Cheyenne, Silverado	<b>US5074</b>	2.5L L4 2457cc 153 CID	2013-2015	LS, LT, LTZ; Pump only	<b>US8102</b>
6.5L V8 395 CID	1999	Base, LS; Bolt on pulley	<b>US5074</b>	2.5L L4 2457cc 153 CID	2015	LS, LT, LTZ	<b>US8102</b>
6.5L V8 395 CID	1999-2000	Base, LS	<b>US5086</b>	3.1L V6 189 CID	1997-2003	Base, LS	<b>US5033</b>
7.4L V8 454 CID	1988-1990	Cheyenne, Scottsdale, Silverado; High performance	<b>US5038H</b>	3.2L L6 3180cc 194 CID	1966	With A/C	<b>US927</b>
7.4L V8 454 CID	1988-1992	Cheyenne, Scottsdale, Silverado	<b>US5038</b>	3.3L V6 200 CID	1978-1979		<b>US1121</b>
7.4L V8 454 CID	1991-1993	Cheyenne, Silverado; High performance	<b>US5038H</b>	3.3L V6 200 CID	1978-1979	High performance	<b>US1121H</b>
7.4L V8 454 CID	1993	Cheyenne, Silverado	<b>US5038</b>	3.5L V6 213 CID	2004	LS, LT, Maxx, Maxx LS, Maxx LT	<b>US5033</b>
7.4L V8 454 CID	1994-1997	Base, Cheyenne, Silverado	<b>US5038</b>	3.5L V6 213 CID	2005	LS, LT, Maxx LS, Maxx LT	<b>US5033</b>
7.4L V8 454 CID	1994-1997	Base, Cheyenne, Silverado; High performance	<b>US5038H</b>	3.5L V6 213 CID	2006	LS, LT, LTZ, Maxx LS, Maxx LT, Maxx LTZ	<b>US5033</b>
7.4L V8 454 CID	1998	Cheyenne, Silverado	<b>US5038</b>	3.5L V6 3490cc 213 CID	2007	LS, LT, LTZ, Maxx LS, Maxx LT, Maxx LTZ	<b>US6020</b>
7.4L V8 454 CID	1998	Cheyenne, Silverado; High performance	<b>US5038H</b>	3.5L V6 3490cc 213 CID	2008	Classic LS, Classic LT, LS	<b>US6020</b>
7.4L V8 454 CID	1999-2000	Base, LS	<b>US5038</b>	3.5L V6 3490cc 213 CID	2009	LS, LT	<b>US6020</b>
7.4L V8 454 CID	1999-2000	Base, LS; High performance	<b>US5038H</b>	3.5L V6 3490cc 213 CID	2010	LS	<b>US6020</b>
<b>KINGSWOOD</b>				3.6L V6 3564cc 217 CID	2008-2012	LT, LTZ	<b>US8932</b>
4.6L V8 4638cc 283 CID	1959-1961		<b>US898</b>	3.8L L6 3769cc 230 CID	1966-1967	With A/C	<b>US927</b>
4.6L V8 4638cc 283 CID	1959-1961	High performance	<b>US898H</b>	3.8L V6 229 CID	1980	Base, Classic, Classic Estate, Classic Landau, Classic Sport, Estate, Sport	<b>US1121</b>
5.0L V8 5031cc 307 CID	1969		<b>US898</b>	3.8L V6 229 CID	1981	Base, Classic, Classic Landau	<b>US1121</b>
5.0L V8 5031cc 307 CID	1969	High performance	<b>US898H</b>	3.8L V6 229 CID	1981	Base, Classic, Classic Landau; High performance	<b>US1121H</b>
5.0L V8 5031cc 307 CID	1971-1972		<b>US898</b>	3.8L V6 229 CID	1982-1983	Classic	<b>US1121</b>
5.0L V8 5031cc 307 CID	1971-1972	High performance	<b>US898H</b>	3.8L V6 229 CID	1982-1983	Classic; High performance	<b>US1121H</b>
5.3L V8 5358cc 327 CID	1969		<b>US898</b>	3.8L V6 231 CID	1979		<b>US1018</b>
5.3L V8 5358cc 327 CID	1969	High performance	<b>US898H</b>	3.8L V6 231 CID	1979	High performance	<b>US1018H</b>
5.7L V8 350 CID	1969-1972		<b>US898</b>	3.8L V6 3800cc 231 CID	1978-1979		<b>US1018</b>
5.7L V8 350 CID	1969-1972	High performance	<b>US898H</b>	3.8L V6 3800cc 231 CID	1978-1979	High performance	<b>US1018H</b>
5.7L V8 5704cc 348 CID	1959-1961		<b>US898</b>	3.8L V6 3800cc 231 CID	1980	Base, Classic, Classic Estate, Classic Landau, Classic Sport, Estate, Sport	<b>US1018</b>
5.7L V8 5704cc 348 CID	1959-1961	High performance	<b>US898H</b>	3.8L V6 3800cc 231 CID	1980	Base, Classic, Classic Estate, Classic Landau, Classic Sport, Estate, Sport; High performance	<b>US1018H</b>
5.7L V8 5736cc 350 CID	1969-1972		<b>US898</b>	3.8L V6 3800cc 231 CID	1981	Base, Classic, Classic Landau	<b>US1018</b>
5.7L V8 5736cc 350 CID	1969-1972	High performance	<b>US898H</b>	3.8L V6 3800cc 231 CID	1981	Base, Classic, Classic Landau; High performance	<b>US1018H</b>
<b>LLV</b>				3.8L V6 3800cc 231 CID	1982-1983	Classic	<b>US1018</b>
2.2L L4 2190cc 134 CID	1994-1995	Base	<b>US5032</b>	3.8L V6 3800cc 231 CID	1982-1983	Classic; High performance	<b>US1018H</b>
2.5L L4 2474cc 151 CID	1987-1993	Base	<b>US5040</b>	3.9L V6 3880cc 237 CID	2006-2007	Maxx SS, SS	<b>US6020</b>
<b>LUMINA</b>				4.1L L6 250 CID	1975-1977		<b>US1107</b>
2.5L L4 2474cc 151 CID	1990-1992	Base	<b>US5041</b>	4.1L L6 4097cc 250 CID	1979		<b>US1107</b>
3.1L V6 189 CID	1990-1994	Base, Euro	<b>US5033</b>	4.1L L6 4098cc 250 CID	1967	With A/C	<b>US927</b>
3.1L V6 189 CID	1995-1996	Base, LS	<b>US5033</b>	4.1L L6 4100cc 250 CID	1965	Mexican Application	<b>US895</b>
3.1L V6 189 CID	1997-1999	Base, LS, LTZ	<b>US5033</b>	4.1L L6 4100cc 250 CID	1967	Mexican Application	<b>US927</b>
3.1L V6 189 CID	2000-2001	Base	<b>US5033</b>	4.1L L6 4100cc 250 CID	1978-1979	Mexican Application	<b>US1107</b>
3.3L V6 3343cc 204 CID	1997	Mexican Application	<b>US5033</b>	4.1L L6 4100cc 250 CID	1981	Mexican Application	<b>US1107</b>
3.4L V6 207 CID	1991	Z34	<b>US5033</b>	4.3L V6 260 CID	1982-1983	Classic	<b>US5012</b>
3.4L V6 207 CID	1992-1994	Euro, Z34	<b>US5033</b>	4.4L V8 267 CID	1980	Base, Classic, Classic Estate, Classic Landau, Classic Sport, Estate, Sport	<b>US1121</b>
3.4L V6 207 CID	1995-1996	LS	<b>US5033</b>	4.4L V8 267 CID	1980	Base, Classic, Classic Estate, Classic Landau, Classic Sport, Estate, Sport; High performance	<b>US1121H</b>
3.4L V6 207 CID	1997	LTZ	<b>US5033</b>	4.4L V8 267 CID	1981	Base, Classic, Classic Landau	<b>US1121</b>
3.8L V6 3800cc 231 CID	1998	LTZ	<b>US5075</b>	4.4L V8 267 CID	1981	Base, Classic, Classic Landau; High performance	<b>US1121H</b>
3.8L V6 3800cc 231 CID	1999	Base, LS, LTZ	<b>US5075</b>	4.4L V8 267 CID	1982	Classic	<b>US1121</b>
<b>LUMINA APV</b>				4.4L V8 267 CID	1982	Classic; High performance	<b>US1121H</b>
3.1L V6 189 CID	1990-1992	Base, CL	<b>US5033</b>	4.6L V8 4638cc 283 CID	1964-1967		<b>US898</b>
3.1L V6 189 CID	1993-1995	Base, LS	<b>US5033</b>	4.6L V8 4638cc 283 CID	1964-1967	High performance	<b>US898H</b>
3.4L V6 207 CID	1996	Base, LS	<b>US5033</b>	5.0L V8 305 CID	1976		<b>US1109</b>
3.8L V6 3800cc 231 CID	1992	Base, CL	<b>US5050</b>	5.0L V8 305 CID	1976	High performance	<b>US1109H</b>
3.8L V6 3800cc 231 CID	1993-1995	Base, LS	<b>US5050</b>	5.0L V8 305 CID	1977-1979		<b>US1121</b>
<b>LUV</b>				5.0L V8 305 CID	1977-1979	High performance	<b>US1121H</b>
1.8L L4 111 CID	1975		<b>US1046</b>	5.0L V8 305 CID	1980	Base, Classic, Classic Estate, Classic Landau, Classic Sport, Estate, Sport	<b>US1121</b>
1.8L L4 111 CID	1975-1979		<b>US1127</b>	5.0L V8 305 CID	1980	Base, Classic, Classic Estate, Classic Landau, Classic Sport, Estate, Sport; High performance	<b>US1121H</b>
1.8L L4 111 CID	1980-1982	Base, Mikado, Sport	<b>US1127</b>				
2.2L L4 134 CID	1982	Base, Mikado, Sport	<b>US9132</b>				
2.2L L4 2190cc 133 CID	1997-1999	Mexican Application	<b>US5032</b>				

Engine	Years	Application Description	USMW	Engine	Years	Application Description	USMW
<b>CHEVROLET (cont'd.)</b>				<b>CHEVROLET (cont'd.)</b>			
<b>MALIBU (cont'd.)</b>				<b>MONTE CARLO (cont'd.)</b>			
5.0L V8 305 CID	1981	Base, Classic, Classic Landau	US1121	4.3L V6 260 CID	1982	Base	US5012
5.0L V8 305 CID	1981	Base, Classic, Classic Landau; High performance	US1121H	4.3L V6 260 CID	1983	Base, CL	US5012
5.0L V8 305 CID	1982-1983	Classic	US1121	4.3L V6 262 CID	1985	Base	US1121
5.0L V8 305 CID	1982-1983	Classic; High performance	US1121H	4.3L V6 262 CID	1985	Base; High performance	US1121H
5.3L V8 5358cc 327 CID	1964-1967		US898	4.3L V6 262 CID	1986-1988	Base, LS	US1121
5.3L V8 5358cc 327 CID	1964-1967	High performance	US898H	4.3L V6 262 CID	1986-1988	Base, LS; High performance	US1121H
5.7L V8 350 CID	1976		US1109	4.4L V8 267 CID	1980	Landau, Sport	US1121
5.7L V8 350 CID	1976	High performance	US1109H	4.4L V8 267 CID	1980	Landau, Sport; High performance	US1121H
5.7L V8 350 CID	1977-1979		US1121	4.4L V8 267 CID	1981	Base, Landau	US1121
5.7L V8 350 CID	1977-1979	High performance	US1121H	4.4L V8 267 CID	1981	Base, Landau; High performance	US1121H
5.7L V8 350 CID	1980	Base, Estate, Sport	US1121	4.4L V8 267 CID	1982	Base	US1121
5.7L V8 350 CID	1980	Base, Estate, Sport; High performance	US1121H	4.4L V8 267 CID	1982	Base; High performance	US1121H
5.7L V8 350 CID	1981	Base	US1121	5.0L V8 305 CID	1976		US1109
5.7L V8 350 CID	1981	Base; High performance	US1121H	5.0L V8 305 CID	1976	High performance	US1109H
5.7L V8 350 CID	1982-1983	Classic; Exc.Air Cond	US1100	5.0L V8 305 CID	1977-1979		US1121
5.7L V8 350 CID	1982-1983	Classic; With air cond.	US1120	5.0L V8 305 CID	1977-1979	High performance	US1121H
5.7L V8 350 CID	1982-1983	Classic; High performance, With air cond.	US1120H	5.0L V8 305 CID	1980	Landau, Sport	US1121
5.7L V8 5700cc 350 CID	1979-1981	Mexican Application	US1121	5.0L V8 305 CID	1980	Landau, Sport; High performance	US1121H
6.5L V8 6489cc 396 CID	1966-1967		US981	5.0L V8 305 CID	1981	Base, Landau	US1121
6.6L V8 400 CID	1975-1976		US1109	5.0L V8 305 CID	1981	Base, Landau; High performance	US1121H
6.6L V8 400 CID	1975-1976	High performance	US1109H	5.0L V8 305 CID	1982	Base	US1121
7.4L V8 454 CID	1975		US1002	5.0L V8 305 CID	1982	Base; High performance	US1121H
7.4L V8 454 CID	1975	High performance	US1002H	5.0L V8 305 CID	1983	Base, CL, SS	US1121
<b>MALIBU LIMITED</b>				5.0L V8 305 CID	1983	Base, CL, SS; High performance	US1121H
2.5L L4 2457cc 153 CID	2016	LS, LT, LTZ	US8102	5.0L V8 305 CID	1984-1985	Base, SS	US1121
<b>MATIZ</b>				5.0L V8 305 CID	1984-1985	Base, SS; High performance	US1121H
1.0L L4 995cc 61 CID	2011-2015		US8928	5.0L V8 305 CID	1986-1988	Base, LS, SS	US1121
<b>MERIVA</b>				5.0L V8 305 CID	1986-1988	Base, LS, SS; High performance	US1121H
1.8L L4 1796cc 110 CID	2004-2008		US8938	5.3L V8 5328cc 325 CID	2006-2007	SS	US6154
<b>METRO</b>				5.7L V8 350 CID	1976		US1109
1.0L L3 993cc 61 CID	1998-2000	Base	US5058	5.7L V8 350 CID	1976	High performance	US1109H
1.3L L4 1295cc 79 CID	1998	LSi	US5058	5.7L V8 350 CID	1977	High performance	US1121
1.3L L4 1295cc 79 CID	1999-2000	Base, LSi	US5058	5.7L V8 350 CID	1977	High performance	US1121H
1.3L L4 1295cc 79 CID	2001	LSi	US5058	5.7L V8 350 CID	1977	High performance	US1121H
<b>MICROBUS</b>				5.7L V8 350 CID	1977	High performance	US1121H
5.7L V8 5700cc 350 CID	1986-1987	Mexican Application	US1121	5.7L V8 350 CID	1977	High performance	US1121H
5.7L V8 5700cc 350 CID	1990-1996	Mexican Application	US5049	5.7L V8 350 CID	1977	High performance	US1121H
<b>MILENIO</b>				5.7L V8 350 CID	1977	High performance	US1121H
1.6L L4 1600cc 98 CID	2000	Mexican Application	US5057	5.7L V8 350 CID	1977	High performance	US1121H
<b>MONTE CARLO</b>				5.7L V8 350 CID	1977	High performance	US1121H
3.1L V6 189 CID	1995-1999	LS	US5033	5.7L V8 350 CID	1977	High performance	US1121H
3.3L V6 200 CID	1978-1979		US1121	5.7L V8 350 CID	1977	High performance	US1121H
3.3L V6 200 CID	1978-1979	High performance	US1121H	5.7L V8 350 CID	1977	High performance	US1121H
3.4L V6 207 CID	1995-1997	Z34	US5033	5.7L V8 350 CID	1977	High performance	US1121H
3.4L V6 207 CID	2000-2002	LS	US5033	5.7L V8 350 CID	1977	High performance	US1121H
3.4L V6 207 CID	2003	LS, LS Competition, LS Sport	US5033	5.7L V8 350 CID	1977	High performance	US1121H
3.4L V6 207 CID	2004-2005	LS	US5033	5.7L V8 350 CID	1977	High performance	US1121H
3.5L V6 3490cc 213 CID	2006-2007	LS, LT	US6020	5.7L V8 350 CID	1977	High performance	US1121H
3.8L V6 229 CID	1980	Landau, Sport	US1121	5.7L V8 350 CID	1977	High performance	US1121H
3.8L V6 229 CID	1980	Landau, Sport; High performance	US1121H	5.7L V8 350 CID	1977	High performance	US1121H
3.8L V6 229 CID	1981	Base, Landau	US1121	5.7L V8 350 CID	1977	High performance	US1121H
3.8L V6 229 CID	1981	Base, Landau; High performance	US1121H	5.7L V8 350 CID	1977	High performance	US1121H
3.8L V6 229 CID	1982	Base	US1121	5.7L V8 350 CID	1977	High performance	US1121H
3.8L V6 229 CID	1982	Base; High performance	US1121H	5.7L V8 350 CID	1977	High performance	US1121H
3.8L V6 229 CID	1983	Base, CL	US1121	5.7L V8 350 CID	1977	High performance	US1121H
3.8L V6 229 CID	1983	Base, CL; High performance	US1121H	5.7L V8 350 CID	1977	High performance	US1121H
3.8L V6 229 CID	1984	Base	US1121	5.7L V8 350 CID	1977	High performance	US1121H
3.8L V6 229 CID	1984	Base; High performance	US1121H	5.7L V8 350 CID	1977	High performance	US1121H
3.8L V6 231 CID	1979		US1018	5.7L V8 350 CID	1977	High performance	US1121H
3.8L V6 231 CID	1979	High performance	US1018H	5.7L V8 350 CID	1977	High performance	US1121H
3.8L V6 3800cc 231 CID	1978-1979		US1018	5.7L V8 350 CID	1977	High performance	US1121H
3.8L V6 3800cc 231 CID	1978-1979	High performance	US1018H	5.7L V8 350 CID	1977	High performance	US1121H
3.8L V6 3800cc 231 CID	1980	Landau, Sport	US1018	5.7L V8 350 CID	1977	High performance	US1121H
3.8L V6 3800cc 231 CID	1980	Landau, Sport; High performance	US1018H	5.7L V8 350 CID	1977	High performance	US1121H
3.8L V6 3800cc 231 CID	1981	Base, Landau	US1018	5.7L V8 350 CID	1977	High performance	US1121H
3.8L V6 3800cc 231 CID	1981	Base, Landau; High performance	US1018H	5.7L V8 350 CID	1977	High performance	US1121H
3.8L V6 3800cc 231 CID	1982	Base	US1018	5.7L V8 350 CID	1977	High performance	US1121H
3.8L V6 3800cc 231 CID	1982	Base; High performance	US1018H	5.7L V8 350 CID	1977	High performance	US1121H
3.8L V6 3800cc 231 CID	1983	Base, CL	US1018	5.7L V8 350 CID	1977	High performance	US1121H
3.8L V6 3800cc 231 CID	1983	Base, CL; High performance	US1018H	5.7L V8 350 CID	1977	High performance	US1121H
3.8L V6 3800cc 231 CID	1984	Base	US1018	5.7L V8 350 CID	1977	High performance	US1121H
3.8L V6 3800cc 231 CID	1984	Base; High performance	US1018H	5.7L V8 350 CID	1977	High performance	US1121H
3.8L V6 3800cc 231 CID	1988	Z34	US5075	5.7L V8 350 CID	1977	High performance	US1121H
3.8L V6 3800cc 231 CID	1988	Z34	US5075	5.7L V8 350 CID	1977	High performance	US1121H
3.8L V6 3800cc 231 CID	1999	Indianapolis 500 Pace Car, LS, Z34	US5075	5.7L V8 350 CID	1977	High performance	US1121H
3.8L V6 3800cc 231 CID	2000-2001	SS	US5075	5.7L V8 350 CID	1977	High performance	US1121H
3.8L V6 3800cc 231 CID	2002	SS, SS 35th Anniversary Edition, SS Dale Earnhardt Signature Edition	US5075	5.7L V8 350 CID	1977	High performance	US1121H
3.8L V6 3800cc 231 CID	2003	SS, SS High Sport, SS Pace Car	US5075	5.7L V8 350 CID	1977	High performance	US1121H
3.8L V6 3800cc 231 CID	2004	SS	US5075	5.7L V8 350 CID	1977	High performance	US1121H
3.8L V6 3800cc 231 CID	2005	LT, SS	US5075	5.7L V8 350 CID	1977	High performance	US1121H
3.9L V6 3880cc 237 CID	2006	LT, LTZ	US6020	5.7L V8 350 CID	1977	High performance	US1121H
<b>MONZA</b>				5.7L V8 350 CID	1977	High performance	US1121H
1.6L L4 1600cc 98 CID	1997-2003	Mexican Application	US5057	5.7L V8 350 CID	1977	High performance	US1121H
2.3L L4 2294cc 140 CID	1975		US1088	5.7L V8 350 CID	1977	High performance	US1121H
2.5L L4 2474cc 151 CID	1978-1979		US1107	5.7L V8 350 CID	1977	High performance	US1121H
2.5L L4 2474cc 151 CID	1980	2+2, 2+2 Sport, 2+2 Spyder, Base, Spyder	US1107	5.7L V8 350 CID	1977	High performance	US1121H
3.2L V6 196 CID	1978-1979		US1018	5.7L V8 350 CID	1977	High performance	US1121H
3.2L V6 196 CID	1978-1979	High performance	US1018H	5.7L V8 350 CID	1977	High performance	US1121H
3.8L V6 231 CID	1979		US1018	5.7L V8 350 CID	1977	High performance	US1121H
3.8L V6 3800cc 231 CID	1978-1979		US1018	5.7L V8 350 CID	1977	High performance	US1121H
3.8L V6 3800cc 231 CID	1978-1979	High performance	US1018H	5.7L V8 350 CID	1977	High performance	US1121H
3.8L V6 3800cc 231 CID	1980	2+2, 2+2 Sport, 2+2 Spyder, Base, Spyder	US1018	5.7L V8 350 CID	1977	High performance	US1121H
3.8L V6 3800cc 231 CID	1980	2+2, 2+2 Sport, 2+2 Spyder, Base, Spyder; High performance	US1018H	5.7L V8 350 CID	1977	High performance	US1121H
4.3L V8 262 CID	1975-1976		US1069	5.7L V8 350 CID	1977	High performance	US1121H
5.0L V8 305 CID	1976-1979		US1069	5.7L V8 350 CID	1977	High performance	US1121H
<b>MONZA POP</b>				5.7L V8 350 CID	1977	High performance	US1121H
1.4L L4 1400cc 85 CID	2002	Mexican Application	US5057	5.7L V8 350 CID	1977	High performance	US1121H
<b>NOVA</b>				5.7L V8 350 CID	1977	High performance	US1121H
1.6L L4 1588cc 98 CID	1985-1988	Base, CL	US9057	5.7L V8 350 CID	1977	High performance	US1121H
1.6L L4 1588cc 98 CID	1988	Twin Cam	US9076	5.7L V8 350 CID	1977	High performance	US1121H
3.8L L6 230 CID	1969	With A/C	US927	5.7L V8 350 CID	1977	High performance	US1121H
4.1L L6 250 CID	1969	With A/C	US927	5.7L V8 350 CID	1977	High performance	US1121H
4.1L L6 250 CID	1974	With A/C	US927	5.7L V8 350 CID	1977	High performance	US1121H
4.1L L6 250 CID	1975-1979		US1107	5.7L V8 350 CID	1977	High performance	US1121H
5.0L V8 305 CID	1976		US1109	5.7L V8 350 CID	1977	High performance	US1121H
5.0L V8 305 CID	1976	High performance	US1109H	5.7L V8 350 CID	1977	High performance	US1121H
5.0L V8 305 CID	1977-1979		US1121	5.7L V8 350 CID	1977	High performance	US1121H
5.0L V8 305 CID	1977-1979	High performance	US1121H	5.7L V8 350 CID	1977	High performance	US1121H
5.7L V8 350 CID	1976		US1109	5.7L V8 350 CID	1977	High performance	US1121H
5.7L V8 350 CID	1976	High performance	US1109H	5.7L V8 350 CID	1977	High performance	US1121H
5.7L V8 350 CID	1977-1979		US1121	5.7L V8 350 CID	1977	High performance	US1121H
5.7L V8 350 CID	1977-1979	High performance	US1121H	5.7L V8 350 CID	1977	High performance	US1121H
5.7L V8 350 CID	1977-1979	High performance	US1109H	5.7L V8 350 CID	1977	High performance	US1121H
5.7L V8 350 CID	1977-1979	High performance	US1121	5.7L V8 350 CID	1977	High performance	US1121H
5.7L V8 350 CID	1977-1979	High performance	US1121H	5.7L V8 350 CID	1977	High performance	US1121H
<b>ONE-FIFTY SERIES</b>				5.7L V8 350 CID	1977	High performance	US1121H
4.3L V8 4343cc 265 CID	1955-1957						



Engine	Years	Application Description	USMW
<b>CHEVROLET (cont'd.)</b>			
<b>ONE-FIFTY SERIES (cont'd.)</b>			
4.6L V8 4638cc 283 CID	1957		<b>US898</b>
4.6L V8 4638cc 283 CID	1957	High performance	<b>US898H</b>
<b>OPTRA</b>			
2.0L L4 1999cc 122 CID	2010	Mexican Application	<b>US8925</b>
2.0L L4 2000cc 122 CID	2006-2009	Mexican Application	<b>US8925</b>
<b>P10</b>			
4.8L L6 292 CID	1975-1979		<b>US5030</b>
4.8L L6 292 CID	1980	Base, Step-Van	<b>US5030</b>
<b>P10 SERIES</b>			
4.3L L6 4278cc 261 CID	1961-1962		<b>US898</b>
4.3L L6 4278cc 261 CID	1961-1962	High performance	<b>US898H</b>
4.6L V8 4638cc 283 CID	1961-1962		<b>US898</b>
4.6L V8 4638cc 283 CID	1961-1962	High performance	<b>US898H</b>
4.8L L6 4801cc 292 CID	1967		<b>US896</b>
<b>P20</b>			
4.8L L6 292 CID	1975-1977		<b>US1137</b>
4.8L L6 292 CID	1975-1977	High performance	<b>US1137H</b>
4.8L L6 292 CID	1978-1979		<b>US5030</b>
4.8L L6 292 CID	1980-1985	Base, Step-Van	<b>US5030</b>
4.8L L6 292 CID	1986	Base	<b>US5030</b>
4.8L L6 292 CID	1987-1989	Base, Step-Van	<b>US5030</b>
5.7L V8 350 CID	1975-1976		<b>US1109</b>
5.7L V8 350 CID	1975-1976	High performance	<b>US1109H</b>
5.7L V8 350 CID	1977-1979		<b>US1121</b>
5.7L V8 350 CID	1977-1979	High performance	<b>US1121H</b>
5.7L V8 350 CID	1980-1985	Base, Step-Van	<b>US1121</b>
5.7L V8 350 CID	1986	Base	<b>US1121</b>
5.7L V8 350 CID	1987-1989	Base, Step-Van	<b>US1121</b>
6.2L V8 379 CID	1982-1985	Base, Step-Van	<b>US5008</b>
6.2L V8 379 CID	1986	Base	<b>US5008</b>
6.2L V8 379 CID	1987-1989	Base, Step-Van	<b>US5008</b>
<b>P20 SERIES</b>			
4.8L L6 4801cc 292 CID	1965-1967		<b>US896</b>
<b>P20 VAN</b>			
4.8L L6 292 CID	1968-1974		<b>US896</b>
4.8L L6 4786cc 292 CID	1973-1974		<b>US896</b>
5.0L V8 307 CID	1968-1969		<b>US898</b>
5.0L V8 307 CID	1968-1969	High performance	<b>US898H</b>
5.7L V8 350 CID	1970-1972		<b>US898</b>
5.7L V8 350 CID	1970-1972	High performance	<b>US898H</b>
<b>P30</b>			
4.3L V6 262 CID	1990	Base, Step-Van	<b>US1121</b>
4.3L V6 262 CID	1990	Base, Step-Van; High performance	<b>US1121H</b>
4.3L V6 262 CID	1991-1995	Base	<b>US1121</b>
4.3L V6 262 CID	1991-1995	Base; High performance	<b>US1121H</b>
4.3L V6 262 CID	1996-1999	Base	<b>US5077</b>
4.3L V6 262 CID	1996-1999	Base; High performance	<b>US5077H</b>
4.3L V6 4300cc 262 CID	2001	High performance	<b>US5077H</b>
4.8L L6 292 CID	1975-1977		<b>US1137</b>
4.8L L6 292 CID	1975-1977	High performance	<b>US1137H</b>
4.8L L6 292 CID	1978-1979		<b>US5030</b>
4.8L L6 292 CID	1980-1985	Base, Step-Van	<b>US5030</b>
4.8L L6 292 CID	1986	Base	<b>US5030</b>
4.8L L6 292 CID	1987-1989	Base, Step-Van	<b>US5030</b>
5.7L V8 350 CID	1975-1976		<b>US1109</b>
5.7L V8 350 CID	1975-1976	High performance	<b>US1109H</b>
5.7L V8 350 CID	1977-1979		<b>US1121</b>
5.7L V8 350 CID	1977-1979	High performance	<b>US1121H</b>
5.7L V8 350 CID	1980-1985	Base, Step-Van	<b>US1121</b>
5.7L V8 350 CID	1985	Base, Step-Van; High performance	<b>US1121H</b>
5.7L V8 350 CID	1986	Base	<b>US1121</b>
5.7L V8 350 CID	1986	Base; High performance	<b>US1121H</b>
5.7L V8 350 CID	1987-1990	Base, Step-Van	<b>US1121</b>
5.7L V8 350 CID	1987-1990	Base, Step-Van; High performance	<b>US1121H</b>
5.7L V8 350 CID	1991-1996	Base	<b>US1121</b>
5.7L V8 350 CID	1991-1996	Base; High performance	<b>US1121H</b>
5.7L V8 350 CID	1997-1999	Base	<b>US5077</b>
5.7L V8 350 CID	1997-1999	Base; High performance	<b>US5077H</b>
6.2L V8 379 CID	1982-1985	Base, Step-Van	<b>US5008</b>
6.2L V8 379 CID	1986	Base	<b>US5008</b>
6.2L V8 379 CID	1987-1990	Base, Step-Van	<b>US5008</b>
6.2L V8 379 CID	1991-1993	Base	<b>US5008</b>
6.5L V8 395 CID	1994-1996	Base	<b>US5062</b>
6.5L V8 395 CID	1997-1998	Base	<b>US5074</b>
6.5L V8 395 CID	1999	Base	<b>US5086</b>
6.6L V8 400 CID	1976		<b>US1109</b>
6.6L V8 400 CID	1976	High performance	<b>US1109H</b>
7.4L V8 454 CID	1975-1979		<b>US1002</b>
7.4L V8 454 CID	1975-1979	High performance	<b>US1002H</b>
7.4L V8 454 CID	1980-1985	Base, Step-Van	<b>US1002</b>
7.4L V8 454 CID	1985	Base, Step-Van; High performance	<b>US1002H</b>
7.4L V8 454 CID	1986	Base	<b>US1002</b>

Engine	Years	Application Description	USMW
<b>CHEVROLET (cont'd.)</b>			
<b>P30 (cont'd.)</b>			
7.4L V8 454 CID	1986	Base; High performance	<b>US1002H</b>
7.4L V8 454 CID	1987-1990	Base, Step-Van	<b>US1002</b>
7.4L V8 454 CID	1987-1990	Base, Step-Van; High performance	<b>US1002H</b>
7.4L V8 454 CID	1991-1999	Base	<b>US1002</b>
7.4L V8 454 CID	1991-1999	Base; High performance	<b>US1002H</b>
<b>P30 SERIES</b>			
4.3L L6 4278cc 261 CID	1961-1962		<b>US898</b>
4.3L L6 4278cc 261 CID	1961-1962	High performance	<b>US898H</b>
4.6L V8 4638cc 283 CID	1961-1962		<b>US898</b>
4.6L V8 4638cc 283 CID	1961-1962	High performance	<b>US898H</b>
4.8L L6 4801cc 292 CID	1965-1967		<b>US896</b>
5.7L V8 5704cc 348 CID	1960-1965		<b>US898</b>
5.7L V8 5704cc 348 CID	1960-1965	High performance	<b>US898H</b>
<b>P30 VAN</b>			
4.1L L6 4100cc 250 CID	1998-2002	Mexican Application	<b>US5030</b>
4.3L V6 4300cc 262 CID	2001	Mexican Application	<b>US5077</b>
4.8L L6 292 CID	1968-1974		<b>US896</b>
4.8L L6 4786cc 292 CID	1973-1974		<b>US896</b>
5.0L V8 307 CID	1968-1969		<b>US898</b>
5.0L V8 307 CID	1968-1969	High performance	<b>US898H</b>
5.7L V8 350 CID	1970-1972		<b>US898</b>
5.7L V8 350 CID	1970-1972	High performance	<b>US898H</b>
5.7L V8 5700cc 350 CID	1989-1991	Mexican Application	<b>US5049</b>
6.6L V8 402 CID	1972		<b>US981</b>
<b>P31 VAN</b>			
4.8L L6 4800cc 292 CID	1991	Mexican Application	<b>US1137</b>
5.7L V8 5737cc 350 CID	1991-1995	Mexican Application	<b>US1121</b>
5.7L V8 5737cc 350 CID	1996	Mexican Application	<b>US5049</b>
5.7L V8 5737cc 350 CID	1998-1999	Mexican Application	<b>US5077</b>
<b>P60</b>			
7.0L V8 6998cc 427 CID	1990	With threaded hub for fan clutch	<b>US5078</b>
7.0L V8 6998cc 427 CID	1990	Without threaded hub	<b>US5084</b>
7.0L V8 6998cc 427 CID	1992-1996	With threaded hub for fan clutch	<b>US5078</b>
<b>P6000</b>			
6.0L V8 366 CID	1992-1996	With threaded hub for fan clutch	<b>US5078</b>
7.0L V8 6998cc 427 CID	1992-1996	With threaded hub for fan clutch	<b>US5078</b>
<b>POP</b>			
1.4L L4 1400cc 85 CID	1996-2001	Mexican Application	<b>US5057</b>
1.6L L4 1600cc 98 CID	2002-2003	Mexican Application	<b>US5057</b>
<b>PRIZM</b>			
1.8L L4 110 CID	1998-2002	Base, LSi	<b>US9376</b>
<b>R10</b>			
4.3L V6 262 CID	1987	Custom Deluxe, Scottsdale, Silverado	<b>US1121</b>
4.3L V6 262 CID	1987	Custom Deluxe, Scottsdale, Silverado; High performance	<b>US1121H</b>
5.0L V8 305 CID	1987	Custom Deluxe, Scottsdale, Silverado	<b>US1121</b>
5.0L V8 305 CID	1987	Custom Deluxe, Scottsdale, Silverado; High performance	<b>US1121H</b>
5.7L V8 350 CID	1987	Custom Deluxe, Scottsdale, Silverado	<b>US1121</b>
5.7L V8 350 CID	1987	Custom Deluxe, Scottsdale, Silverado; High performance	<b>US1121H</b>
6.2L V8 379 CID	1987	Custom Deluxe, Scottsdale, Silverado	<b>US5008</b>
<b>R10 SUBURBAN</b>			
5.0L V8 305 CID	1987	Custom Deluxe, Scottsdale, Silverado	<b>US1121</b>
5.0L V8 305 CID	1987	Custom Deluxe, Scottsdale, Silverado; High performance	<b>US1121H</b>
5.7L V8 350 CID	1987	Custom Deluxe, Scottsdale, Silverado	<b>US5049</b>
5.7L V8 350 CID	1987	Custom Deluxe, Scottsdale, Silverado; High performance	<b>US5049H</b>
5.7L V8 350 CID	1988	Scottsdale, Silverado	<b>US5049</b>
5.7L V8 350 CID	1988	Scottsdale, Silverado; High performance	<b>US5049H</b>
6.2L V8 379 CID	1987	Custom Deluxe, Scottsdale, Silverado	<b>US5008</b>
6.2L V8 379 CID	1988	Scottsdale, Silverado	<b>US5008</b>
<b>R20</b>			
4.3L V6 262 CID	1987	Custom Deluxe, Scottsdale, Silverado	<b>US1121</b>
4.3L V6 262 CID	1987	Custom Deluxe, Scottsdale, Silverado; High performance	<b>US1121H</b>
4.8L L6 292 CID	1987	Custom Deluxe, Scottsdale, Silverado	<b>US5030</b>
4.8L L6 292 CID	1988	Cheyenne, Custom Deluxe, Scottsdale, Silverado	<b>US5030</b>
5.0L V8 305 CID	1987	Custom Deluxe, Scottsdale, Silverado	<b>US1121</b>
5.0L V8 305 CID	1987	Custom Deluxe, Scottsdale, Silverado; High performance	<b>US1121H</b>
5.7L V8 350 CID	1987	Custom Deluxe, Scottsdale, Silverado	<b>US1121</b>
5.7L V8 350 CID	1987	Custom Deluxe, Scottsdale, Silverado; High performance	<b>US1121H</b>
5.7L V8 350 CID	1988	Cheyenne, Custom Deluxe, Scottsdale, Silverado	<b>US1121</b>
5.7L V8 350 CID	1988	Cheyenne, Scottsdale, Silverado; High performance	<b>US1121H</b>
6.2L V8 379 CID	1987	Custom Deluxe, Scottsdale, Silverado	<b>US5008</b>

Engine	Years	Application Description	USMW	Engine	Years	Application Description	USMW
<b>CHEVROLET (cont'd.)</b>				<b>CHEVROLET (cont'd.)</b>			
<b>R20 (cont'd.)</b>				<b>S10 (cont'd.)</b>			
6.2L V8 379 CID	1988	Cheyenne, Custom Deluxe, Scottsdale, Silverado	US5008	2.5L L4 2474cc 151 CID	1987-1989	Base, Durango, Sport, Tahoe	US5040
7.4L V8 454 CID	1987	Custom Deluxe, Scottsdale, Silverado	US1002	2.5L L4 2474cc 151 CID	1990	Base, Durango, Tahoe	US5040
7.4L V8 454 CID	1987	Custom Deluxe, Scottsdale, Silverado; High performance	US1002H	2.5L L4 2474cc 151 CID	1991	Base, Tahoe	US5040
7.4L V8 454 CID	1988	Cheyenne, Custom Deluxe, Scottsdale, Silverado	US1002	2.5L L4 2474cc 151 CID	1992	Base, EL, Tahoe	US5040
7.4L V8 454 CID	1988	Cheyenne, Custom Deluxe, Scottsdale, Silverado; High performance	US1002H	2.5L L4 2474cc 151 CID	1993	Base, EL	US5040
<b>R20 SUBURBAN</b>				2.8L V6 173 CID	1982	Base, Durango, Sport	US5006
5.7L V8 350 CID	1987	Custom Deluxe, Scottsdale, Silverado	US5049	2.8L V6 173 CID	1983-1986	Base, Durango, Sport, Tahoe	US5006
5.7L V8 350 CID	1987	Custom Deluxe, Scottsdale, Silverado; High performance	US5049H	2.8L V6 173 CID	1987-1989	Base, Durango, Sport, Tahoe	US5035
5.7L V8 350 CID	1988	Scottsdale, Silverado	US5049	2.8L V6 173 CID	1990	Base, Durango, Tahoe	US5035
5.7L V8 350 CID	1988	Scottsdale, Silverado; High performance	US5049H	2.8L V6 173 CID	1991	Baja, Base, Tahoe	US5035
6.2L V8 379 CID	1987	Custom Deluxe, Scottsdale, Silverado	US5008	2.8L V6 173 CID	1992	Base, EL, Tahoe	US5035
6.2L V8 379 CID	1988	Scottsdale, Silverado	US5008	2.8L V6 173 CID	1993	Base, EL	US5035
7.4L V8 454 CID	1987	Custom Deluxe, Scottsdale, Silverado	US1002	4.3L V6 262 CID	1988-1989	Base, Durango, Sport, Tahoe	US5049
7.4L V8 454 CID	1987	Custom Deluxe, Scottsdale, Silverado; High performance	US1002H	4.3L V6 262 CID	1988-1989	Base, Durango, Sport, Tahoe; High performance	US5049H
7.4L V8 454 CID	1988	Scottsdale, Silverado	US1002	4.3L V6 262 CID	1990	Base, Durango, Tahoe	US5049
7.4L V8 454 CID	1988	Scottsdale, Silverado; High performance	US1002H	4.3L V6 262 CID	1990	Base, Durango, Tahoe; High performance	US5049H
<b>R30</b>				4.3L V6 262 CID	1991	Baja, Base, Tahoe	US5049
4.8L L6 292 CID	1987	Custom Deluxe, Scottsdale, Silverado	US5030	4.3L V6 262 CID	1991	Baja, Base, Tahoe; High performance	US5049H
4.8L L6 292 CID	1988	Cheyenne, Custom Deluxe, Scottsdale, Silverado	US5030	4.3L V6 262 CID	1992	Base, EL, Tahoe	US5049
5.7L V8 350 CID	1987	Custom Deluxe, Scottsdale, Silverado	US1121	4.3L V6 262 CID	1992	Base, EL, Tahoe; High performance	US5049H
5.7L V8 350 CID	1987	Custom Deluxe, Scottsdale, Silverado; High performance	US1121H	4.3L V6 262 CID	1993	Base, EL	US5049
5.7L V8 350 CID	1988	Cheyenne, Custom Deluxe, Scottsdale, Silverado	US1121	4.3L V6 262 CID	1993	Base, EL; High performance	US5049H
5.7L V8 350 CID	1988	Cheyenne, Scottsdale, Silverado; High performance	US1121H	4.3L V6 262 CID	1994-1995	Base, LS, SS, ZR2	US5049
6.2L V8 379 CID	1987	Custom Deluxe, Scottsdale, Silverado	US5008	4.3L V6 262 CID	1994-1995	Base, LS, SS, ZR2; High performance	US5049H
6.2L V8 379 CID	1988	Cheyenne, Custom Deluxe, Scottsdale, Silverado	US5008	4.3L V6 262 CID	1996-1998	Base, LS, SS, ZR2	US5077
7.4L V8 454 CID	1987	Custom Deluxe, Scottsdale, Silverado	US1002	4.3L V6 262 CID	1996-1998	Base, LS, SS, ZR2; High performance	US5077H
7.4L V8 454 CID	1987	Custom Deluxe, Scottsdale, Silverado; High performance	US1002H	4.3L V6 262 CID	1999-2001	Base, LS, Xtreme, ZR2	US5077
7.4L V8 454 CID	1988	Cheyenne, Custom Deluxe, Scottsdale, Silverado	US1121	4.3L V6 262 CID	1999-2001	Base, LS, Xtreme, ZR2; High performance	US5077H
7.4L V8 454 CID	1988	Cheyenne, Scottsdale, Silverado; High performance	US1121H	4.3L V6 262 CID	2002-2003	Base, LS, Xtreme, ZR2, ZR5	US5077
7.4L V8 454 CID	1987	Custom Deluxe, Scottsdale, Silverado	US5008	4.3L V6 262 CID	2002-2003	Base, LS, Xtreme, ZR2, ZR5; High performance	US5077H
7.4L V8 454 CID	1987	Custom Deluxe, Scottsdale, Silverado; High performance	US1002H	4.3L V6 262 CID	2004	LS, ZR5	US5077
7.4L V8 454 CID	1988	Cheyenne, Custom Deluxe, Scottsdale, Silverado	US5008	4.3L V6 262 CID	2004	LS, ZR5; High performance	US5077H
7.4L V8 454 CID	1987	Custom Deluxe, Scottsdale, Silverado	US1002	<b>S10 BLAZER</b>			
7.4L V8 454 CID	1987	Custom Deluxe, Scottsdale, Silverado; High performance	US1002H	1.9L L4 119 CID	1983-1984	Base, Sport, Tahoe	US5013
7.4L V8 454 CID	1988	Cheyenne, Custom Deluxe, Scottsdale, Silverado	US1002	2.0L L4 122 CID	1983-1984	Base, Sport, Tahoe	US5015
7.4L V8 454 CID	1988	Cheyenne, Scottsdale, Silverado; High performance	US1002H	2.5L L4 2474cc 151 CID	1985-1986	Base, Sport, Tahoe	US5022
7.4L V8 454 CID	1988	Cheyenne, Custom Deluxe, Scottsdale, Silverado	US1002	2.5L L4 2474cc 151 CID	1987-1988	Base, High Country, Sport, Tahoe	US5040
7.4L V8 454 CID	1988	Cheyenne, Scottsdale, Silverado; High performance	US1002H	2.8L V6 173 CID	1983-1986	Base, Sport, Tahoe	US5006
<b>R1500 SUBURBAN</b>				2.8L V6 173 CID	1987-1988	Base, High Country, Sport, Tahoe	US5035
5.7L V8 350 CID	1989-1991	Scottsdale, Silverado	US5049	2.8L V6 173 CID	1989	Base, High Country, Sport	US5035
5.7L V8 350 CID	1989-1991	Scottsdale, Silverado; High performance	US5049H	3.1L V6 3100cc 191 CID	1990-1994	Mexican Application	US5033
6.2L V8 379 CID	1989-1991	Scottsdale, Silverado	US5062	4.3L V6 262 CID	1988	Base, High Country, Sport, Tahoe	US5049
<b>R2500</b>				4.3L V6 262 CID	1988	Base, High Country, Sport, Tahoe; High performance	US5049H
5.7L V8 350 CID	1989	Silverado	US1121	4.3L V6 262 CID	1989	Base, High Country, Sport	US5049
6.2L V8 379 CID	1989	Cheyenne, Scottsdale, Silverado	US5008	4.3L V6 262 CID	1989	Base, High Country, Sport; High performance	US5049H
7.4L V8 454 CID	1989	Cheyenne, Scottsdale, Silverado	US1002	4.3L V6 262 CID	1990	Base, Sport, Tahoe	US5049
7.4L V8 454 CID	1989	Cheyenne, Scottsdale, Silverado; High performance	US1002H	4.3L V6 262 CID	1990	Base, Sport, Tahoe; High performance	US5049H
<b>R2500 SUBURBAN</b>				4.3L V6 262 CID	1991	Base, Tahoe, Tahoe LT	US5049
5.7L V8 350 CID	1989-1991	Scottsdale, Silverado	US5049	4.3L V6 262 CID	1991	Base, Tahoe, Tahoe LT; High performance	US5049H
5.7L V8 350 CID	1989-1991	Scottsdale, Silverado; High performance	US5049H	4.3L V6 262 CID	1992	Base, Sport, Tahoe, Tahoe LT	US5049
6.2L V8 379 CID	1989-1991	Scottsdale, Silverado	US5062	4.3L V6 262 CID	1992	Base, Sport, Tahoe, Tahoe LT; High performance	US5049H
7.4L V8 454 CID	1989-1991	Scottsdale, Silverado	US5038	4.3L V6 262 CID	1993	Base, Tahoe, Tahoe LT	US5049
7.4L V8 454 CID	1989-1991	Scottsdale, Silverado; High performance	US5038H	4.3L V6 262 CID	1993	Base, Tahoe, Tahoe LT; High performance	US5049H
<b>R3500</b>				4.3L V6 262 CID	1994	Base, LT, Tahoe, Tahoe LT	US5049
5.7L V8 350 CID	1989-1990	Cheyenne, Scottsdale, Silverado	US1121	4.3L V6 262 CID	1994	Base, LT, Tahoe, Tahoe LT; High performance	US5049H
5.7L V8 350 CID	1989-1990	Cheyenne, Scottsdale, Silverado; High performance	US1121H	<b>SEDAN DELIVERY</b>			
5.7L V8 350 CID	1991	Cheyenne, Silverado	US1121	3.8L L6 3852cc 235 CID	1947-1951		US43N
5.7L V8 350 CID	1991	Cheyenne, Silverado; High performance	US1121H	3.8L L6 3852cc 235 CID	1953-1954		US43N
6.2L V8 379 CID	1989-1990	Cheyenne, Scottsdale, Silverado	US5008	<b>SILVERADO</b>			
6.2L V8 379 CID	1991	Cheyenne, Silverado	US5008	5.7L V8 5700cc 350 CID	1995	Mexican Application	US5049
7.4L V8 454 CID	1989-1990	Cheyenne, Scottsdale, Silverado	US1002	5.7L V8 5700cc 350 CID	1996-1997	Mexican Application	US5077
7.4L V8 454 CID	1989-1990	Cheyenne, Scottsdale, Silverado; High performance	US1002H	<b>SILVERADO 1500</b>			
7.4L V8 454 CID	1991	Cheyenne, Silverado	US1002	4.3L V6 262 CID	1999-2001	Base, LS, LT	US5077
7.4L V8 454 CID	1991	Cheyenne, Silverado; High performance	US1002H	4.3L V6 262 CID	1999-2001	Base, LS, LT; High performance	US5077H
<b>S10</b>				4.3L V6 262 CID	2002-2003	Base, LS, LT, WT	US5077
1.9L L4 119 CID	1982	Base, Durango, Sport	US5013	4.3L V6 262 CID	2002-2003	Base, LS, LT, WT; High performance	US5077H
1.9L L4 119 CID	1983-1985	Base, Durango, Sport, Tahoe	US5013	4.3L V6 262 CID	2004	Base, LS, LT, WT, Z71	US5077
2.0L L4 122 CID	1983-1984	Base, Durango, Sport, Tahoe	US5015	4.3L V6 262 CID	2004	Base, LS, LT, WT, Z71; High performance	US5077H
2.2L L4 2190cc 134 CID	1994-1998	Base, LS	US5032	4.3L V6 262 CID	2005	Base, LS, LT	US5077
2.2L L4 2190cc 134 CID	1999-2003	Base, LS, Xtreme	US5032	4.3L V6 262 CID	2005	Base, LS, LT; High performance	US5077H
2.2L L4 2200cc 134 CID	2001-2002	Mexican Application	US5032	4.3L V6 262 CID	2006	LS, WT	US5077
2.5L L4 2474cc 151 CID	1985-1986	Base, Durango, Sport, Tahoe	US5022	4.3L V6 262 CID	2006	LS, WT; High performance	US5077H
				4.3L V6 262 CID	2007-2011	WT; High performance	US5077H
				4.3L V6 262 CID	2007-2012	WT	US5077
				4.3L V6 262 CID	2014	LT, WT	US8918

WATER PUMPS



Engine	Years	Application Description	USMW	Engine	Years	Application Description	USMW
<b>CHEVROLET (cont'd.)</b>				<b>CHEVROLET (cont'd.)</b>			
<b>SILVERADO 1500 (cont'd.)</b>				<b>SILVERADO 1500 HD (cont'd.)</b>			
4.3L V6 262 CID	2015	LS, LT, WT	<b>US8918</b>	6.0L V8 5967cc 364 CID	2005	Base, LS, LT	<b>US64</b>
4.3L V6 262 CID	2016-2017	Custom, LS, LT, WT	<b>US8918</b>	6.0L V8 5967cc 364 CID	2005	Base, LS, LT; Includes thermostat and thermostat housing	<b>US64-T</b>
4.3L V6 4293cc 262 CID	2013	WT	<b>US5077</b>	6.0L V8 5967cc 364 CID	2006	LT	<b>US64</b>
4.3L V6 4300cc 262 CID	2013-2014	Mexican Application	<b>US5077</b>	6.0L V8 5967cc 364 CID	2006	LT; Includes thermostat and thermostat housing	<b>US64-T</b>
4.8L V8 294 CID	1999-2001	Base, LS, LT	<b>US64</b>	<b>SILVERADO 1500 HD CLASSIC</b>			
4.8L V8 294 CID	1999-2001	Base, LS, LT; Includes thermostat and thermostat housing	<b>US64-T</b>	6.0L V8 5967cc 364 CID	2007	LT	<b>US6009</b>
4.8L V8 294 CID	2002-2003	Base, LS, LT, WT	<b>US64</b>	6.0L V8 5967cc 364 CID	2007	LT; Includes thermostat and thermostat housing	<b>US6009-T</b>
4.8L V8 294 CID	2002-2003	Base, LS, LT, WT; Includes thermostat and thermostat housing	<b>US64-T</b>	<b>SILVERADO 2500</b>			
4.8L V8 294 CID	2004	Base, LS, LT, WT, Z71	<b>US64</b>	4.8L V8 4800cc 293 CID	2006-2009	Mexican Application	<b>US64</b>
4.8L V8 294 CID	2004	Base, LS, LT, WT, Z71; Includes thermostat and thermostat housing	<b>US64-T</b>	4.8L V8 4800cc 293 CID	2010-2011	Mexican Application	<b>US6009</b>
4.8L V8 294 CID	2005	Base, LS, LT	<b>US64</b>	4.8L V8 4800cc 293 CID	2013	Mexican Application	<b>US6009</b>
4.8L V8 294 CID	2005	Base, LS, LT; Includes thermostat and thermostat housing	<b>US64-T</b>	5.3L V8 5300cc 323 CID	2003	Mexican Application	<b>US5087</b>
4.8L V8 294 CID	2006	LS, LT, WT	<b>US64</b>	5.3L V8 5300cc 323 CID	2004-2009	Mexican Application	<b>US64</b>
4.8L V8 294 CID	2006	LS, LT, WT; Includes thermostat and thermostat housing	<b>US64-T</b>	5.3L V8 5300cc 323 CID	2010-2011	Mexican Application	<b>US6009</b>
4.8L V8 294 CID	2007	LT, WT	<b>US6009</b>	5.3L V8 5328cc 323 CID	2014	Mexican Application	<b>US6009</b>
4.8L V8 294 CID	2007	LT, WT; Includes thermostat and thermostat housing	<b>US6009-T</b>	5.3L V8 5328cc 325 CID	1999-2000	Base, LS, LT	<b>US64</b>
4.8L V8 294 CID	2008-2013	LS, LT, WT	<b>US6009</b>	5.3L V8 5328cc 325 CID	1999-2000	Base, LS, LT; Includes thermostat and thermostat housing	<b>US64-T</b>
4.8L V8 294 CID	2008-2013	LS, LT, WT; Includes thermostat and thermostat housing	<b>US6009-T</b>	5.3L V8 5328cc 325 CID	2013	Mexican Application	<b>US6009</b>
5.3L V8 5328cc 325 CID	1999-2001	Base, LS, LT	<b>US64</b>	5.3L V8 5328cc 325 CID	2015-2016	Mexican Application	<b>US6009</b>
5.3L V8 5328cc 325 CID	1999-2001	Base, LS, LT; Includes thermostat and thermostat housing	<b>US64-T</b>	5.7L V8 5737cc 350 CID	2001	Mexican Application	<b>US5087</b>
5.3L V8 5328cc 325 CID	2002-2003	Base, LS, LT, WT	<b>US64</b>	5.7L V8 5737cc 350 CID	2002	Mexican Application	<b>US64</b>
5.3L V8 5328cc 325 CID	2002-2003	Base, LS, LT, WT; Includes thermostat and thermostat housing	<b>US64-T</b>	6.0L V8 5967cc 364 CID	1999-2003	Base, LS, LT	<b>US64</b>
5.3L V8 5328cc 325 CID	2004	Base, Hybrid, LS, LT, WT, Z71	<b>US64</b>	6.0L V8 5967cc 364 CID	1999-2003	Base, LS, LT; Includes thermostat and thermostat housing	<b>US64-T</b>
5.3L V8 5328cc 325 CID	2004	Base, Hybrid, LS, LT, WT, Z71; Includes thermostat and thermostat housing	<b>US64-T</b>	6.0L V8 5967cc 364 CID	2004	Base, LS, LT, WT	<b>US64</b>
5.3L V8 5328cc 325 CID	2005	Base, Hybrid, LS, LT	<b>US64</b>	6.0L V8 5967cc 364 CID	2004	Base, LS, LT, WT; Includes thermostat and thermostat housing	<b>US64-T</b>
5.3L V8 5328cc 325 CID	2005	Base, Hybrid, LS, LT; Includes thermostat and thermostat housing	<b>US64-T</b>	<b>SILVERADO 2500 HD</b>			
5.3L V8 5328cc 325 CID	2006	Hybrid, LS, LT, WT	<b>US64</b>	6.0L V8 5967cc 364 CID	2001-2003	Base, LS, LT	<b>US64</b>
5.3L V8 5328cc 325 CID	2006	Hybrid, LS, LT, WT; Includes thermostat and thermostat housing	<b>US64-T</b>	6.0L V8 5967cc 364 CID	2001-2003	Base, LS, LT; Includes thermostat and thermostat housing	<b>US64-T</b>
5.3L V8 5328cc 325 CID	2007-2009	LT, LTZ, WT	<b>US6009</b>	6.0L V8 5967cc 364 CID	2004-2005	Base, LS, LT, WT	<b>US64</b>
5.3L V8 5328cc 325 CID	2007-2009	LT, LTZ, WT; Includes thermostat and thermostat housing	<b>US6009-T</b>	6.0L V8 5967cc 364 CID	2004-2005	Base, LS, LT, WT; Includes thermostat and thermostat housing	<b>US64-T</b>
5.3L V8 5328cc 325 CID	2010-2013	LS, LT, LTZ, WT, XFE	<b>US6009</b>	6.0L V8 5967cc 364 CID	2006	LS, LT, WT	<b>US64</b>
5.3L V8 5328cc 325 CID	2010-2013	LS, LT, LTZ, WT, XFE; Includes thermostat and thermostat housing	<b>US6009-T</b>	6.0L V8 5967cc 364 CID	2006	LS, LT, WT; Includes thermostat and thermostat housing	<b>US64-T</b>
5.3L V8 5328cc 325 CID	2014	High Country, LT, WT	<b>US8918</b>	6.0L V8 5967cc 364 CID	2007-2014	LT, LTZ, WT	<b>US6009</b>
5.3L V8 5328cc 325 CID	2015	High Country, LS, LT, LTZ, SSV, WT	<b>US8918</b>	6.0L V8 5967cc 364 CID	2007-2014	LT, LTZ, WT; Includes thermostat and thermostat housing	<b>US6009-T</b>
5.3L V8 5328cc 325 CID	2016-2017	Custom, High Country, LS, LT, LTZ, SSV, WT	<b>US8918</b>	6.0L V8 5967cc 364 CID	2015-2017	High Country, LT, LTZ, WT	<b>US6009</b>
6.0L V8 5967cc 364 CID	2003	SS	<b>US64</b>	6.6L V8 6599cc 403 CID	2001-2003	Base, LS, LT	<b>US6009</b>
6.0L V8 5967cc 364 CID	2003	SS; Includes thermostat and thermostat housing	<b>US64-T</b>	6.6L V8 6599cc 403 CID	2004	Base, LS, LT, WT	<b>US63</b>
6.0L V8 5967cc 364 CID	2004-2005	LS, LT, SS	<b>US64</b>	6.6L V8 6599cc 403 CID	2005	Base, LS, LT	<b>US63</b>
6.0L V8 5967cc 364 CID	2004-2005	LS, LT, SS; Includes thermostat and thermostat housing	<b>US64-T</b>	6.6L V8 6599cc 403 CID	2006	LS, LT, WT	<b>US72</b>
6.0L V8 5967cc 364 CID	2006	LT, SS	<b>US64</b>	6.6L V8 6599cc 403 CID	2007-2014	LT, LTZ, WT	<b>US72</b>
6.0L V8 5967cc 364 CID	2006	LT, SS; Includes thermostat and thermostat housing	<b>US64-T</b>	6.6L V8 6599cc 403 CID	2015-2016	High Country, LT, LTZ, WT	<b>US72</b>
6.0L V8 5967cc 364 CID	2007-2008	LT, LTZ	<b>US6009</b>	6.6L V8 6599cc 403 CID	2017	High Country, LT, LTZ, WT	<b>US310</b>
6.0L V8 5967cc 364 CID	2007-2008	LT, LTZ; Includes thermostat and thermostat housing	<b>US6009-T</b>	8.1L V8 496 CID	2001-2003	Base, LS, LT	<b>US5089</b>
6.0L V8 5967cc 364 CID	2009	Hybrid, LT, LTZ	<b>US6009</b>	8.1L V8 496 CID	2001-2003	Base, LS, LT; High performance	<b>US5089H</b>
6.0L V8 5967cc 364 CID	2009	Hybrid, LT, LTZ; Includes thermostat and thermostat housing	<b>US6009-T</b>	8.1L V8 496 CID	2004-2005	Base, LS, LT, WT	<b>US5089</b>
6.0L V8 5967cc 364 CID	2010-2013	Hybrid	<b>US6009</b>	8.1L V8 496 CID	2004-2005	Base, LS, LT, WT; High performance	<b>US5089H</b>
6.0L V8 5967cc 364 CID	2010-2013	Hybrid; Includes thermostat and thermostat housing	<b>US6009-T</b>	8.1L V8 496 CID	2006	LS, LT, WT	<b>US5089</b>
6.2L V8 6162cc 376 CID	2009	LTZ	<b>US6009</b>	8.1L V8 496 CID	2006	LS, LT, WT; High performance	<b>US5089H</b>
6.2L V8 6162cc 376 CID	2009	LTZ; Includes thermostat and thermostat housing	<b>US6009-T</b>	<b>SILVERADO 2500 HD CLASSIC</b>			
6.2L V8 6162cc 376 CID	2010-2013	LT, LTZ	<b>US6009</b>	6.0L V8 5967cc 364 CID	2007	LS, LT, WT	<b>US6009</b>
6.2L V8 6162cc 376 CID	2010-2013	LT, LTZ; Includes thermostat and thermostat housing	<b>US6009-T</b>	6.0L V8 5967cc 364 CID	2007	LS, LT, WT; Includes thermostat and thermostat housing	<b>US6009-T</b>
6.2L V8 6162cc 376 CID	2014-2017	High Country, LTZ	<b>US8918</b>	6.6L V8 6599cc 403 CID	2007	LS, LT, WT	<b>US72</b>
<b>SILVERADO 1500 CLASSIC</b>				8.1L V8 496 CID	2007	LS, LT, WT; High performance	<b>US5089H</b>
4.3L V6 262 CID	2007	LS, WT	<b>US5077</b>	<b>SILVERADO 3500</b>			
4.8L V8 294 CID	2007	LS, LT, WT	<b>US6009</b>	5.7L V8 5737cc 350 CID	2001-2003	Mexican Application	<b>US5087</b>
4.8L V8 294 CID	2007	LS, LT, WT; Includes thermostat and thermostat housing	<b>US6009-T</b>	5.7L V8 5737cc 350 CID	2007	Mexican Application	<b>US64</b>
5.3L V8 5328cc 325 CID	2007	Hybrid, LS, LT, WT	<b>US6009</b>	6.0L V8 5967cc 364 CID	2001-2003	Base, LS, LT	<b>US64</b>
5.3L V8 5328cc 325 CID	2007	Hybrid, LS, LT, WT; Includes thermostat and thermostat housing	<b>US6009-T</b>	6.0L V8 5967cc 364 CID	2001-2003	Base, LS, LT; Includes thermostat and thermostat housing	<b>US64-T</b>
6.0L V8 5967cc 364 CID	2007	LT, SS	<b>US6009</b>	6.0L V8 5967cc 364 CID	2004	Base, LS, LT, WT	<b>US64</b>
6.0L V8 5967cc 364 CID	2007	LT, SS; Includes thermostat and thermostat housing	<b>US6009-T</b>	6.0L V8 5967cc 364 CID	2004	Base, LS, LT, WT; Includes thermostat and thermostat housing	<b>US64-T</b>
<b>SILVERADO 1500 HD</b>				6.0L V8 5967cc 364 CID	2005	Base, LS, LT	<b>US64</b>
6.0L V8 5967cc 364 CID	2001-2003	LS, LT	<b>US64</b>	6.0L V8 5967cc 364 CID	2005	Base, LS, LT; Includes thermostat and thermostat housing	<b>US64-T</b>
6.0L V8 5967cc 364 CID	2001-2003	LS, LT; Includes thermostat and thermostat housing	<b>US64-T</b>	6.0L V8 5967cc 364 CID	2006	LS, LT, WT	<b>US64</b>
				6.0L V8 5967cc 364 CID	2006	LT; Includes thermostat and thermostat housing	<b>US64-T</b>
				6.0L V8 5967cc 364 CID	2006	LS, LT, WT; Includes thermostat and thermostat housing	<b>US64-T</b>
				6.0L V8 5967cc 364 CID	2006	LS, LT, WT	<b>US64</b>
				6.0L V8 5967cc 364 CID	2006	LS, LT, WT; Includes thermostat and thermostat housing	<b>US64-T</b>
				6.0L V8 5967cc 364 CID	2008-2013	Mexican Application	<b>US6009</b>
				6.0L V8 5967cc 364 CID	2015-2016	Mexican Application	<b>US6009</b>
				6.6L V8 6599cc 403 CID	2001-2003	Base, LS, LT	<b>US63</b>
				6.6L V8 6599cc 403 CID	2004	Base, LS, LT, WT	<b>US63</b>
				6.6L V8 6599cc 403 CID	2005	Base, LS, LT	<b>US63</b>
				6.6L V8 6599cc 403 CID	2006	LS, LT, WT	<b>US72</b>



Engine	Years	Application Description	USMW	Engine	Years	Application Description	USMW
<b>CHEVROLET (cont'd.)</b>				<b>CHEVROLET (cont'd.)</b>			
<b>SILVERADO 3500 (cont'd.)</b>				<b>SUBURBAN (cont'd.)</b>			
8.1L V8 496 CID	2001-2003	Base, LS, LT	US5089	5.3L V8 5358cc 327 CID	1966		US898
8.1L V8 496 CID	2001-2003	Base, LS, LT; High performance	US5089H	5.3L V8 5358cc 327 CID	1966	High performance	US898H
8.1L V8 496 CID	2004	Base, LS, LT, WT	US5089	5.7L V8 5704cc 348 CID	1960-1961		US898
8.1L V8 496 CID	2004	Base, LS, LT, WT; High performance	US5089H	5.7L V8 5704cc 348 CID	1960-1961	High performance	US898H
8.1L V8 496 CID	2005	Base, LS, LT	US5089	<b>SUBURBAN 1500</b>			
8.1L V8 496 CID	2005	Base, LS, LT; High performance	US5089H	5.3L V8 5300cc 323 CID	2006	Mexican Application	US64
8.1L V8 496 CID	2006	LS, LT, WT	US5089	5.3L V8 5328cc 325 CID	2000-2001	Base, LS, LT	US64
8.1L V8 496 CID	2006	LS, LT, WT; High performance	US5089H	5.3L V8 5328cc 325 CID	2000-2001	Base, LS, LT; Includes thermostat and thermostat housing	US64-T
<b>SILVERADO 3500 CLASSIC</b>				5.3L V8 5328cc 325 CID	2002-2003	LS, LT	US64
6.0L V8 5967cc 364 CID	2007	LS, LT, WT	US6009	5.3L V8 5328cc 325 CID	2002-2003	LS, LT; Includes thermostat and thermostat housing	US64-T
6.0L V8 5967cc 364 CID	2007	LS, LT, WT; Includes thermostat and thermostat housing	US6009-T	5.3L V8 5328cc 325 CID	2004-2005	LS, LT, Z71	US64
6.6L V8 6599cc 403 CID	2007	LS, LT, WT	US72	5.3L V8 5328cc 325 CID	2004-2005	LS, LT, Z71; Includes thermostat and thermostat housing	US64-T
8.1L V8 496 CID	2007	LS, LT, WT	US5089	5.3L V8 5328cc 325 CID	2006	Base, LS, LT, Z71	US64
8.1L V8 496 CID	2007	LS, LT, WT; High performance	US5089H	5.3L V8 5328cc 325 CID	2006	Base, LS, LT, Z71; Includes thermostat and thermostat housing	US64-T
<b>SILVERADO 3500 HD</b>				5.3L V8 5328cc 325 CID	2007	LS, LT, LTZ, Z71	US6009
6.0L V8 5967cc 364 CID	2007-2014	LT, LTZ, WT	US6009	5.3L V8 5328cc 325 CID	2007	LS, LT, LTZ, Z71; Includes thermostat and thermostat housing	US6009-T
6.0L V8 5967cc 364 CID	2007-2014	LT, LTZ, WT; Includes thermostat and thermostat housing	US6009-T	5.3L V8 5328cc 325 CID	2008-2014	LS, LT, LTZ	US6009
6.0L V8 5967cc 364 CID	2015-2017	High Country, LT, LTZ, WT	US6009	5.3L V8 5328cc 325 CID	2008-2014	LS, LT, LTZ; Includes thermostat and thermostat housing	US6009-T
6.6L V8 6599cc 403 CID	2007-2014	LT, LTZ, WT	US72	5.7L V8 350 CID	2001-2002	High performance	US5077H
6.6L V8 6599cc 403 CID	2015-2016	High Country, LT, LTZ, WT	US72	5.7L V8 5733cc 350 CID	2002	Mexican Application	US5087
6.6L V8 6599cc 403 CID	2017	High Country, LT, LTZ, WT	US310	5.7L V8 5737cc 350 CID	2001	Mexican Application	US5087
<b>SONIC</b>				6.0L V8 5967cc 364 CID	2006	LTZ	US64
1.4L L4 1364cc 83 CID	2012	LT, LTZ	US6662	6.0L V8 5967cc 364 CID	2006	LTZ; Includes thermostat and thermostat housing	US64-T
1.4L L4 1364cc 83 CID	2013-2016	LT, LTZ, RS	US6662	6.0L V8 5967cc 364 CID	2007-2009	LT, LTZ	US6009
1.4L L4 1364cc 83 CID	2017	LT, Premier	US6662	6.0L V8 5967cc 364 CID	2007-2009	LT, LTZ; Includes thermostat and thermostat housing	US6009-T
1.6L L4 1598cc 97 CID	2012-2013	Mexican Application	US6184	<b>SUBURBAN 2500</b>			
1.6L L4 1600cc 98 CID	2014-2016	Mexican Application	US6184	6.0L V8 5967cc 364 CID	2000-2001	Base, LS, LT	US64
1.8L L4 1796cc 110 CID	2012-2014	LS, LT, LTZ	US6184	6.0L V8 5967cc 364 CID	2000-2001	Base, LS, LT; Includes thermostat and thermostat housing	US64-T
1.8L L4 1796cc 110 CID	2015-2017	LS, LT	US6184	6.0L V8 5967cc 364 CID	2002-2006	LS, LT	US64
<b>SONORA</b>				6.0L V8 5967cc 364 CID	2002-2006	LS, LT; Includes thermostat and thermostat housing	US64-T
4.3L V6 4300cc 262 CID	2003	Mexican Application	US5077	6.0L V8 5967cc 364 CID	2007	LS, LT, LTZ	US6009
5.3L V8 5300cc 323 CID	2003-2004	Mexican Application	US5087	6.0L V8 5967cc 364 CID	2007	LS, LT, LTZ; Includes thermostat and thermostat housing	US6009-T
5.3L V8 5300cc 323 CID	2005-2006	Mexican Application	US64	6.0L V8 5967cc 364 CID	2008-2013	LS, LT	US6009
5.7L V8 5737cc 350 CID	2000-2002	Mexican Application	US5049	6.0L V8 5967cc 364 CID	2008-2013	LS, LT; Includes thermostat and thermostat housing	US6009-T
6.0L V8 6000cc 364 CID	2003	Mexican Application	US5087	8.1L V8 496 CID	2001	Base, LS, LT	US5089
<b>SPARK</b>				8.1L V8 496 CID	2001	Base, LS, LT; High performance	US5089H
1.2L L4 1200cc 73 CID	2011-2015	Mexican Application	US8984	8.1L V8 496 CID	2002-2006	LS, LT	US5089
1.2L L4 1206cc 74 CID	2012	Base	US8984	8.1L V8 496 CID	2002-2006	LS, LT; High performance	US5089H
1.2L L4 1206cc 74 CID	2012	Base; Includes back housing	US8984-2	<b>SUBURBAN 3500 HD</b>			
1.2L L4 1206cc 74 CID	2013	LTZ	US8984	6.0L V8 5967cc 364 CID	2016-2017	LS, LT	US6009
1.2L L4 1206cc 74 CID	2013	LTZ	US8984	<b>SWING</b>			
1.2L L4 1206cc 74 CID	2013	LTZ	US8984	1.4L L4 1400cc 85 CID	1994-1995	Mexican Application	US5057
1.2L L4 1206cc 74 CID	2013	LTZ	US8984	1.6L L4 1600cc 98 CID	1996-2003	Mexican Application	US5057
1.2L L4 1206cc 74 CID	2013	LTZ; Includes back housing	US8984-2	<b>T6500</b>			
1.2L L4 1206cc 74 CID	2014	Byte, DOT, LTZ, ZMX	US8984	6.0L V8 366 CID	1997-1998	With threaded hub for fan clutch	US5078
1.2L L4 1206cc 74 CID	2014	Byte, DOT, LTZ, ZMX; Includes back housing	US8984-2	7.8L L6 475 CID	2000-2002	8 vane impeller, Medium/Heavy Duty	US73
1.2L L4 1206cc 74 CID	2014	Byte, DOT, LTZ, ZMX; Includes back housing	US8984-2	<b>T7500</b>			
1.2L L4 1249cc 76 CID	2013-2015	LS, LT	US8999	6.0L V8 366 CID	1997-1998	With threaded hub for fan clutch	US5078
1.4L L4 1399cc 85 CID	2016	LS, LT	US8147	7.8L L6 475 CID	2000-2002	8 vane impeller, Medium/Heavy Duty	US73
1.4L L4 1399cc 85 CID	2016	LS, LT; Pump only	US8147	<b>TAHOE</b>			
1.4L L4 1399cc 85 CID	2017	ACTIV, LS, LT	US8147	4.8L V8 294 CID	2000-2001	Base, LS, LT	US64
1.4L L4 1399cc 85 CID	2017	ACTIV, LS, LT; Pump only	US8147	4.8L V8 294 CID	2000-2001	Base, LS, LT; Includes thermostat and thermostat housing	US64-T
<b>SPECTRUM</b>				4.8L V8 294 CID	2002	LS, LT	US64
1.5L L4 1471cc 92 CID	1985-1986	Base	US5031	4.8L V8 294 CID	2002	LS, LT; Includes thermostat and thermostat housing	US64-T
1.5L L4 1471cc 92 CID	1987-1988	Base, CL, CL Plus, Express, Turbo	US5031	4.8L V8 294 CID	2003-2004	LS, LT, Z71	US64
<b>SPRINT</b>				4.8L V8 294 CID	2003-2004	LS, LT, Z71	US64
1.0L L3 993cc 61 CID	1985	Base	US5029	4.8L V8 294 CID	2003-2004	LS, LT, Z71; Includes thermostat and thermostat housing	US64-T
1.0L L3 993cc 61 CID	1986	Base, ER, Plus	US5029	4.8L V8 294 CID	2005	LS	US64
1.0L L3 993cc 61 CID	1987-1988	Base, ER, Metro, Turbo	US5029	4.8L V8 294 CID	2005	LS; Includes thermostat and thermostat housing	US64-T
<b>SS</b>				4.8L V8 294 CID	2006	Base, LS	US64
6.2L V8 6162cc 376 CID	2014-2017	Base	US79	4.8L V8 294 CID	2006	Base, LS; Includes thermostat and thermostat housing	US64-T
<b>SSR</b>				4.8L V8 294 CID	2007-2009	LS	US6009
5.3L V8 5328cc 325 CID	2003-2004	Base	US64	4.8L V8 294 CID	2007-2009	LS; Includes thermostat and thermostat housing	US6009-T
5.3L V8 5328cc 325 CID	2003-2004	Base; Includes thermostat and thermostat housing	US64-T	5.3L V8 5328cc 325 CID	2000-2001	Base, LS, LT	US64
6.0L V8 5967cc 364 CID	2005-2006	Base	US64	5.3L V8 5328cc 325 CID	2000-2001	Base, LS, LT; Includes thermostat and thermostat housing	US64-T
6.0L V8 5967cc 364 CID	2005-2006	Base; Includes thermostat and thermostat housing	US64-T	5.3L V8 5328cc 325 CID	2002	LS, LT	US64
<b>STYLELINE DELUXE</b>				5.3L V8 5328cc 325 CID	2002	LS, LT; Includes thermostat and thermostat housing	US64-T
3.8L L6 3852cc 235 CID	1950-1952		US43N	<b>SUBURBAN</b>			
<b>STYLELINE SPECIAL</b>				4.3L L6 4278cc 261 CID	1961-1962		US898
3.8L L6 3852cc 235 CID	1950-1952		US43N	4.3L L6 4278cc 261 CID	1961-1962	High performance	US898H
<b>SUBURBAN</b>				4.6L V8 4638cc 283 CID	1960-1966		US898
4.3L L6 4278cc 261 CID	1961-1962		US898	4.6L V8 4638cc 283 CID	1960-1966	High performance	US898H
4.3L L6 4278cc 261 CID	1961-1962	High performance	US898H	4.8L L6 4801cc 292 CID	1965-1966		US896
4.6L V8 4638cc 283 CID	1960-1966		US898	5.3L V8 5328cc 325 CID	2010-2012	Mexican Application	US6009
4.6L V8 4638cc 283 CID	1960-1966	High performance	US898H	5.3L V8 5328cc 325 CID	2015-2016	LS, LT, LTZ	US8918
4.8L L6 4801cc 292 CID	1965-1966		US896	5.3L V8 5328cc 325 CID	2017	LS, LT, Premier	US8918
5.3L V8 5328cc 325 CID	2010-2012	Mexican Application	US6009				
5.3L V8 5328cc 325 CID	2015-2016	LS, LT, LTZ	US8918				
5.3L V8 5328cc 325 CID	2017	LS, LT, Premier	US8918				

WATER PUMPS

Engine	Years	Application Description	USMW	Engine	Years	Application Description	USMW
<b>CHEVROLET (cont'd.)</b>				<b>CHEVROLET (cont'd.)</b>			
<b>TAHOE (cont'd.)</b>				<b>TRAX (cont'd.)</b>			
5.3L V8 5328cc 325 CID	2003-2005	LS, LT, Z71	<b>US64</b>	1.4L L4 1364cc 83 CID	2015-2016	LS, LT, LTZ	<b>US6662</b>
5.3L V8 5328cc 325 CID	2003-2005	LS, LT, Z71; Includes thermostat and thermostat housing	<b>US64-T</b>	1.4L L4 1364cc 83 CID	2017	LS, LT, Premier	<b>US6662</b>
5.3L V8 5328cc 325 CID	2006	Base, LS, LT, Z71	<b>US64</b>	1.8L L4 1796cc 110 CID	2013-2015	Mexican Application	<b>US6184</b>
5.3L V8 5328cc 325 CID	2006	Base, LS, LT, Z71; Includes thermostat and thermostat housing	<b>US64-T</b>	<b>TRUCK</b>			
5.3L V8 5328cc 325 CID	2007-2011	LS, LT, LTZ	<b>US6009</b>	4.3L L6 4278cc 261 CID	1955-1958		<b>US898</b>
5.3L V8 5328cc 325 CID	2007-2011	LS, LT, LTZ; Includes thermostat and thermostat housing	<b>US6009-T</b>	4.3L L6 4278cc 261 CID	1955-1958	High performance	<b>US898H</b>
5.3L V8 5328cc 325 CID	2011-2012	Mexican Application	<b>US6009</b>	4.3L L6 4278cc 261 CID	1960		<b>US898</b>
5.3L V8 5328cc 325 CID	2012-2014	LS, LT, LTZ, PPV, SSV	<b>US6009</b>	4.3L L6 4278cc 261 CID	1960	High performance	<b>US898H</b>
5.3L V8 5328cc 325 CID	2012-2014	LS, LT, LTZ, PPV, SSV; Includes thermostat and thermostat housing	<b>US6009-T</b>	4.3L V8 4343cc 265 CID	1955-1957		<b>US898</b>
5.3L V8 5328cc 325 CID	2015-2016	LS, LT, LTZ, PPV, SSV	<b>US8918</b>	4.3L V8 4343cc 265 CID	1955-1957	High performance	<b>US898H</b>
5.3L V8 5328cc 325 CID	2017	LS, LT, PPV, Premier, SSV	<b>US8918</b>	4.6L V8 4638cc 283 CID	1957-1958		<b>US898</b>
5.7L V8 350 CID	1995	Base, LS, LT	<b>US5049</b>	4.6L V8 4638cc 283 CID	1957-1958	High performance	<b>US898H</b>
5.7L V8 350 CID	1995	Base, LS, LT; High performance	<b>US5049H</b>	4.6L V8 4638cc 283 CID	1960	High performance	<b>US898</b>
5.7L V8 350 CID	1996-1999	Base, LS, LT	<b>US5077</b>	5.3L V8 5272cc 322 CID	1956-1958		<b>US898</b>
5.7L V8 350 CID	1996-1999	Base, LS, LT; High performance	<b>US5077H</b>	5.3L V8 5272cc 322 CID	1956-1958	High performance	<b>US898H</b>
5.7L V8 350 CID	2000	Limited, Z71	<b>US5077</b>	5.3L V8 5310cc 324 CID	1955-1956		<b>US898</b>
5.7L V8 350 CID	2000	Limited, Z71; High performance	<b>US5077H</b>	5.3L V8 5310cc 324 CID	1955-1956	High performance	<b>US898H</b>
6.0L V8 5967cc 364 CID	2008-2013	Hybrid	<b>US6009</b>	5.7L V8 5704cc 348 CID	1958		<b>US898</b>
6.0L V8 5967cc 364 CID	2008-2013	Hybrid; Includes thermostat and thermostat housing	<b>US6009-T</b>	5.7L V8 5704cc 348 CID	1958	High performance	<b>US898H</b>
6.2L V8 6162cc 376 CID	2008-2009	LTZ	<b>US6009</b>	5.7L V8 5704cc 348 CID	1960		<b>US898</b>
6.2L V8 6162cc 376 CID	2008-2009	LTZ; Includes thermostat and thermostat housing	<b>US6009-T</b>	<b>TWO-TEN SERIES</b>			
6.5L V8 395 CID	1995	Base, LS, LT	<b>US5062</b>	4.3L V8 4343cc 265 CID	1955-1957		<b>US898</b>
6.5L V8 395 CID	1996	Base, LS, LT; Early	<b>US5062</b>	4.3L V8 4343cc 265 CID	1955-1957	High performance	<b>US898H</b>
6.5L V8 395 CID	1996	Base, LS, LT; Late	<b>US5074</b>	4.6L V8 4638cc 283 CID	1957		<b>US898</b>
6.5L V8 395 CID	1997-1998	Base, LS, LT	<b>US5074</b>	4.6L V8 4638cc 283 CID	1957	High performance	<b>US898H</b>
6.5L V8 395 CID	1999	Base	<b>US5074</b>	<b>UPLANDER</b>			
<b>TIGRA</b>				3.5L V6 213 CID	2005-2006	Base, LS, LT	<b>US5033</b>
1.6L L4 1600cc 98 CID	1999	Mexican Application	<b>US5057</b>	3.9L V6 3880cc 237 CID	2006	LT	<b>US6020</b>
<b>TORNADO</b>				3.9L V6 3880cc 237 CID	2007-2008	Base, LS, LT	<b>US6020</b>
1.8L L4 1796cc 110 CID	2006-2012		<b>US8938</b>	3.9L V6 3880cc 237 CID	2009	Mexican Application	<b>US6020</b>
1.8L L4 1796cc 110 CID	2013-2015	Mexican Application	<b>US8938</b>	<b>V10</b>			
1.8L L4 1800cc 110 CID	2004-2005		<b>US8938</b>	4.3L V6 262 CID	1987	Custom Deluxe, Scottsdale, Silverado	<b>US1121</b>
<b>TRACKER</b>				4.3L V6 262 CID	1987	Custom Deluxe, Scottsdale, Silverado; High performance	<b>US1121H</b>
1.6L L4 1588cc 98 CID	1998	Base, LSi	<b>US5048</b>	5.0L V8 305 CID	1987	Custom Deluxe, Scottsdale, Silverado	<b>US1121</b>
1.6L L4 1588cc 98 CID	1999-2000	Base, LSi	<b>US9374</b>	5.0L V8 305 CID	1987	Custom Deluxe, Scottsdale, Silverado; High performance	<b>US1121H</b>
2.0L L4 122 CID	1999-2000	Base, LSi	<b>US9342</b>	5.7L V8 350 CID	1987	Custom Deluxe, Scottsdale, Silverado	<b>US1121</b>
2.0L L4 122 CID	2001-2003	Base, LT, ZR2	<b>US9342</b>	5.7L V8 350 CID	1987	Custom Deluxe, Scottsdale, Silverado; High performance	<b>US1121H</b>
2.0L L4 1983cc 121 CID	2005-2008	Mexican Application	<b>US9342</b>	6.2L V8 379 CID	1987	Custom Deluxe, Scottsdale, Silverado	<b>US5008</b>
2.2L L4 2190cc 134 CID	2005	Mexican Application	<b>US5048</b>	<b>V10 SUBURBAN</b>			
2.2L L4 2196cc 134 CID	1999-2001	Mexican Application	<b>US5048</b>	5.7L V8 350 CID	1987	Custom Deluxe, Scottsdale, Silverado	<b>US5049</b>
2.5L V6 2500cc	2001-2003	LT, ZR2	<b>US9385</b>	5.7L V8 350 CID	1987	Custom Deluxe, Scottsdale, Silverado; High performance	<b>US5049H</b>
2.5L V6 2500cc	2004	Base, LT, ZR2	<b>US9385</b>	5.7L V8 350 CID	1988	Scottsdale, Silverado	<b>US5049</b>
<b>TRAILBLAZER</b>				5.7L V8 350 CID	1988	Scottsdale, Silverado; High performance	<b>US5049H</b>
4.2L L6 256 CID	2002-2003	LS, LT, LTZ, North Face	<b>US5097</b>	6.2L V8 379 CID	1987	Custom Deluxe, Scottsdale, Silverado	<b>US5008</b>
4.2L L6 256 CID	2004	LS, LT, North Face	<b>US5097</b>	6.2L V8 379 CID	1988	Scottsdale, Silverado	<b>US5008</b>
4.2L L6 256 CID	2005-2007	LS, LT	<b>US5097</b>	<b>V20</b>			
4.2L L6 256 CID	2008	Base, LT	<b>US5097</b>	4.8L L6 292 CID	1987	Custom Deluxe, Scottsdale, Silverado	<b>US5030</b>
4.2L L6 256 CID	2009	LT	<b>US5097</b>	5.7L V8 350 CID	1987	Custom Deluxe, Scottsdale, Silverado	<b>US1121</b>
5.3L V8 5328cc 325 CID	2006	LS, LT	<b>US64</b>	5.7L V8 350 CID	1987	Custom Deluxe, Scottsdale, Silverado; High performance	<b>US1121H</b>
5.3L V8 5328cc 325 CID	2006	LS, LT; Includes thermostat and thermostat housing	<b>US64-T</b>	5.7L V8 350 CID	1987	Custom Deluxe, Scottsdale, Silverado; High performance	<b>US1121H</b>
5.3L V8 5328cc 325 CID	2007	LS, LT	<b>US6009</b>	6.2L V8 379 CID	1987	Custom Deluxe, Scottsdale, Silverado	<b>US5008</b>
5.3L V8 5328cc 325 CID	2007	LS, LT; Includes thermostat and thermostat housing	<b>US6009-T</b>	<b>V20 SUBURBAN</b>			
5.3L V8 5328cc 325 CID	2008	Base, LT	<b>US6009</b>	5.7L V8 350 CID	1987	Custom Deluxe, Scottsdale, Silverado	<b>US1121</b>
5.3L V8 5328cc 325 CID	2008	Base, LT; Includes thermostat and thermostat housing	<b>US6009-T</b>	5.7L V8 350 CID	1987	Custom Deluxe, Scottsdale, Silverado; High performance	<b>US1121H</b>
6.0L V8 5967cc 364 CID	2006	SS	<b>US64</b>	5.7L V8 350 CID	1988	Scottsdale, Silverado	<b>US5049</b>
6.0L V8 5967cc 364 CID	2006	SS; Includes thermostat and thermostat housing	<b>US64-T</b>	5.7L V8 350 CID	1988	Scottsdale, Silverado; High performance	<b>US5049H</b>
6.0L V8 5967cc 364 CID	2007-2009	SS	<b>US6009</b>	6.2L V8 379 CID	1987	Custom Deluxe, Scottsdale, Silverado	<b>US5008</b>
6.0L V8 5967cc 364 CID	2007-2009	SS; Includes thermostat and thermostat housing	<b>US6009-T</b>	6.2L V8 379 CID	1988	Scottsdale, Silverado	<b>US5008</b>
<b>TRAILBLAZER EXT</b>				7.4L V8 454 CID	1987	Custom Deluxe, Scottsdale, Silverado	<b>US1002</b>
4.2L L6 256 CID	2002	LT, North Face	<b>US5097</b>	7.4L V8 454 CID	1987	Custom Deluxe, Scottsdale, Silverado; High performance	<b>US1002H</b>
4.2L L6 256 CID	2003-2004	LS, LT, North Face	<b>US5097</b>	7.4L V8 454 CID	1988	Scottsdale, Silverado	<b>US1002</b>
4.2L L6 256 CID	2005-2006	LS, LT	<b>US5097</b>	7.4L V8 454 CID	1988	Scottsdale, Silverado; High performance	<b>US1002H</b>
5.3L V8 5328cc 325 CID	2003-2004	LS, LT, North Face	<b>US64</b>	<b>V30</b>			
5.3L V8 5328cc 325 CID	2003-2004	LS, LT, North Face; Includes thermostat and thermostat housing	<b>US64-T</b>	4.8L L6 292 CID	1987	Custom Deluxe, Scottsdale, Silverado	<b>US5030</b>
5.3L V8 5328cc 325 CID	2005-2006	LS, LT	<b>US64</b>	4.8L L6 292 CID	1988	Cheyenne, Custom Deluxe, Scottsdale, Silverado	<b>US5030</b>
5.3L V8 5328cc 325 CID	2005-2006	LS, LT; Includes thermostat and thermostat housing	<b>US64-T</b>	5.7L V8 350 CID	1987	Custom Deluxe, Scottsdale, Silverado	<b>US1121</b>
<b>TRAVERSE</b>				5.7L V8 350 CID	1987	Custom Deluxe, Scottsdale, Silverado; High performance	<b>US1121H</b>
3.6L V6 3564cc 217 CID	2009-2013	LS, LT, LTZ	<b>US8932</b>	5.7L V8 350 CID	1988	Cheyenne, Custom Deluxe, Scottsdale, Silverado	<b>US1121</b>
3.6L V6 3564cc 217 CID	2015-2016	LS, LT, LTZ	<b>US8932</b>	5.7L V8 350 CID	1988	Cheyenne, Custom Deluxe, Scottsdale, Silverado	<b>US1121</b>
3.6L V6 3564cc 217 CID	2017	LS, LT, Premier	<b>US8932</b>	5.7L V8 350 CID	1988	Cheyenne, Scottsdale, Silverado; High performance	<b>US1121H</b>
<b>TRAX</b>							
1.4L L4 1364cc 83 CID	2014	Mexican Application	<b>US6662</b>				

Engine	Years	Application Description	USMW	Engine	Years	Application Description	USMW
<b>CHEVROLET (cont'd.)</b>				<b>CHRYSLER (cont'd.)</b>			
<b>V30 (cont'd.)</b>				<b>300 (cont'd.)</b>			
6.2L V8 379 CID	1987	Custom Deluxe, Scottsdale, Silverado	US5008	3.5L V6 3497cc 215 CID	2010	Limited, S, Touring	US8951
6.2L V8 379 CID	1988	Cheyenne, Custom Deluxe, Scottsdale, Silverado	US5008	3.6L V6 3604cc 220 CID	2011	Base, Limited, Touring	US8981
7.4L V8 454 CID	1987	Custom Deluxe, Scottsdale, Silverado	US1002	3.6L V6 3604cc 220 CID	2012	Base, Limited, S	US8981
7.4L V8 454 CID	1987	Custom Deluxe, Scottsdale, Silverado; High performance	US1002H	3.6L V6 3604cc 220 CID	2013-2014	Base, C, C Luxury, S	US8981
7.4L V8 454 CID	1988	Cheyenne, Custom Deluxe, Scottsdale, Silverado	US1002	3.6L V6 3604cc 220 CID	2015-2017	C, C Platinum, Limited, S	US8981
7.4L V8 454 CID	1988	Cheyenne, Custom Deluxe, Scottsdale, Silverado	US1002	3.6L V6 3604cc 220 CID	2018	Limited, S, Touring	US8981
7.4L V8 454 CID	1988	Cheyenne, Scottsdale, Silverado; High performance	US1002H	5.7L V8 345 CID	2005-2008	C	US8940
<b>V1500 SUBURBAN</b>				5.7L V8 345 CID	2009	C	US8979
5.7L V8 350 CID	1989-1991	Scottsdale, Silverado	US5049	5.7L V8 345 CID	2010	C, S	US8979
5.7L V8 350 CID	1989-1991	Scottsdale, Silverado; High performance	US5049H	5.7L V8 345 CID	2011	C	US8971
6.2L V8 379 CID	1989-1991	Scottsdale, Silverado	US5062	5.7L V8 345 CID	2012	C, S	US8971
<b>V2500 SUBURBAN</b>				5.7L V8 345 CID	2014	C, C Luxury, S	US8115
5.7L V8 350 CID	1989-1991	Scottsdale, Silverado	US5049	5.7L V8 345 CID	2015-2017	C, C Platinum, S	US8115
5.7L V8 350 CID	1989-1991	Scottsdale, Silverado; High performance	US5049H	5.7L V8 345 CID	2018	C, S	US8115
6.2L V8 379 CID	1989-1991	Scottsdale, Silverado	US5062	5.7L V8 5654cc 345 CID	2013	C, C Luxury, S	US8115
7.4L V8 454 CID	1990	Scottsdale, Silverado; High performance	US1002H	6.1L V8 6059cc 370 CID	2005-2010	C SRT8	US8940
7.4L V8 454 CID	1990	Scottsdale, Silverado; High performance	US1002H	6.4L V8 6424cc 392 CID	2012	SRT8	US8971
<b>V3500</b>				6.4L V8 6424cc 392 CID	2014	SRT8	US8115
5.7L V8 350 CID	1989-1990	Cheyenne, Scottsdale, Silverado	US1121	<b>300M</b>			
5.7L V8 350 CID	1989-1990	Cheyenne, Scottsdale, Silverado; High performance	US1121H	3.5L V6 3497cc 215 CID	1999-2001	Base	US7162
5.7L V8 350 CID	1991	Cheyenne, Silverado	US1121	3.5L V6 3497cc 215 CID	2002	Base, Special	US7162
5.7L V8 350 CID	1991	Cheyenne, Silverado; High performance	US1121H	3.5L V6 3497cc 215 CID	2003	Base, Pro-Am, Special	US7162
6.2L V8 379 CID	1989-1990	Cheyenne, Scottsdale, Silverado	US5008	3.5L V6 3497cc 215 CID	2004	Base, Special	US7162
6.2L V8 379 CID	1991	Cheyenne, Silverado	US5008	<b>ASPEN</b>			
7.4L V8 454 CID	1989-1990	Cheyenne, Scottsdale, Silverado	US1002	4.7L V8 287 CID	2007-2009	Limited	US7163
7.4L V8 454 CID	1989-1990	Cheyenne, Scottsdale, Silverado; High performance	US1002H	5.7L V8 345 CID	2007-2008	Limited	US7168
7.4L V8 454 CID	1991	Cheyenne, Silverado	US1002	5.7L V8 345 CID	2009	Limited	US6341
7.4L V8 454 CID	1991	Cheyenne, Silverado; High performance	US1002H	<b>CIRRUS</b>			
7.4L V8 454 CID	1991	Cheyenne, Silverado; High performance	US1002H	2.0L L4 1996cc 122 CID	2000	LX	US7150
<b>VAGONETA</b>				2.0L L4 2001cc 122 CID	1995	Mexican Application	US7150
1.6L L4 1600cc 98 CID	2000-2002	Mexican Application	US5057	2.4L L4 2360cc 144 CID	2010	Mexican Application	US6038
<b>VECTRA</b>				2.4L L4 2426cc 148 CID	1998	Mexican Application	US7152
2.2L L4 2190cc 134 CID	2003-2005	Mexican Application	US5092	2.4L L4 2426cc 148 CID	1999-2000	Mexican Application	US7156
2.8L V6 2800cc 173 CID	2006-2008	Mexican Application	US8932	2.4L L4 2426cc 148 CID	2004	Mexican Application	US7156
3.2L V6 3171cc 193 CID	2004-2005	Mexican Application	US5079	2.4L L4 2429cc 148 CID	1995	LX	US7153
3.2L V6 3199cc 195 CID	2003	Mexican Application	US5079	2.4L L4 2429cc 148 CID	1996	LX; Hydraulic Tensioner	US7153
<b>VEGA</b>				2.4L L4 2429cc 148 CID	1996	LX; Mechanical Tensioner	US7156
2.3L L4 2294cc 140 CID	1975		US1088	2.4L L4 2429cc 148 CID	1997	LX, LXi	US7156
<b>VENTURE</b>				2.4L L4 2429cc 148 CID	1999-2000	LX	US7156
3.4L V6 207 CID	1997-1999	Base, LS	US5033	2.4L L4 2429cc 148 CID	2001-2003	Mexican Application	US7156
3.4L V6 207 CID	2000	Base, LS, LT, Plus, Value, Warner Bros.	US5033	2.4L L4 2429cc 148 CID	2005-2009	Mexican Application	US7156
3.4L V6 207 CID	2001	LS, LT, Plus, Value, Warner Bros.	US5033	2.5L V6 2497cc 152 CID	1995-1997	LX, LXi	US7152
3.4L V6 207 CID	2002	Base, LS, LT, Plus, Value, Warner Bros.	US5033	2.5L V6 2497cc 152 CID	1998-1999	LXi	US7152
3.4L V6 207 CID	2003	LS, LT, Plus, Value, Warner Bros.	US5033	2.5L V6 2497cc 152 CID	2000	LX, LXi	US7152
3.4L V6 207 CID	2004-2005	LS, LT, Plus	US5033	2.7L V6 2736cc 165 CID	2001-2003	Mexican Application	US7161
<b>VOLT</b>				2.7L V6 2737cc 167 CID	2004-2006	Mexican Application	US7161
1.4L L4 1398cc 85 CID	2011-2015	Base	US8152	3.5L V6 3500cc 213 CID	2007-2009	Mexican Application	US8951
1.5L L4 1490cc 91 CID	2016-2017	LT, Premier	US8158	3.5L V6 3518cc 215 CID	2010	Mexican Application	US8951
1.5L L4 1490cc 91 CID	2016-2017	LT, Premier; Pump only	US8158	<b>CONCORDE</b>			
<b>YEOMAN</b>				2.7L V6 2736cc 167 CID	1998-2004	LX	US7161
3.8L L6 3852cc 235 CID	1958		US43N	3.2L V6 3200cc 197 CID	1998-2001	LXi	US7162
<b>ZAFIRA</b>				3.3L V6 3294cc 201 CID	1992	Mexican Application	US7140
1.8L L4 1796cc 109 CID	2002-2005	Mexican Application	US8933	3.3L V6 3301cc 201 CID	1993-1995	Base	US7140
2.2L L4 2190cc 134 CID	2002-2006	Mexican Application	US5092	3.3L V6 3301cc 201 CID	1996	LX	US7140
<b>CHRYSLER</b>				3.5L V6 3497cc 215 CID	1993-1994	Base	US7141
<b>200</b>				3.5L V6 3497cc 215 CID	1995	Base	US7151
2.4L L4 2360cc 144 CID	2011-2014	Limited, LX, Touring	US6038	3.5L V6 3497cc 215 CID	1996	LX, LXi	US7151
2.4L L4 2360cc 144 CID	2015-2017	C, Limited, LX, S	US6038	3.5L V6 3497cc 215 CID	1997	LX, LXi; 3 Bolt Pattern	US7151
3.6L V6 3604cc 220 CID	2011-2014	Limited, LX, S, Touring	US8981	3.5L V6 3497cc 215 CID	1997	LX, LXi; 6 Bolt Pattern	US7158
3.6L V6 3604cc 220 CID	2013	Mexican Application	US8981	3.5L V6 3497cc 215 CID	2002-2004	Limited, LXi	US7162
3.6L V6 3604cc 220 CID	2015-2017	C, Limited, S	US8114	3.5L V6 3526cc 215 CID	1992	Mexican Application	US7141
<b>200C</b>				<b>CONQUEST</b>			
3.6L V6 3605cc 220 CID	2015-2016	Mexican Application	US8981	2.6L L4 2555cc 156 CID	1987	Base	US7120
<b>300</b>				2.6L L4 2555cc 156 CID	1987	Base; From 12/1986	US7124
2.7L V6 2736cc 167 CID	2005-2007	Base	US7161	2.6L L4 2555cc 156 CID	1988-1989	TSi	US7124
2.7L V6 2736cc 167 CID	2008-2009	LX	US6217	<b>CORDOBA</b>			
2.7L V6 2736cc 167 CID	2010	Touring	US6217	3.7L L6 3687cc 225 CID	1980	300, Base, Crown, LS	US7100
3.5L V6 3497cc 213 CID	2010	Mexican Application	US8951	3.7L L6 3687cc 225 CID	1981-1982	Base, LS	US7100
3.5L V6 3497cc 215 CID	2005-2008	Limited, Touring	US8951	3.7L L6 3687cc 225 CID	1983	Base	US7100
3.5L V6 3497cc 215 CID	2009	Limited, Signature Series, Touring	US8951	5.2L V8 318 CID	1975-1978	Exc.Air Pump	US1053
				5.2L V8 318 CID	1975-1978	Exc.Air Pump, High performance	US1053H
				5.2L V8 318 CID	1975-1979	Air Pump	US1053
				5.2L V8 318 CID	1975-1979	Air Pump, High performance	US1053H
				5.2L V8 318 CID	1980	300, Base, Crown	US1053
				5.2L V8 318 CID	1980	300, Base, Crown; High performance	US1053H
				5.2L V8 318 CID	1981-1982	Base, LS	US1053
				5.2L V8 318 CID	1981-1982	Base, LS; High performance	US1053H
				5.2L V8 318 CID	1983	Base	US1053
				5.2L V8 318 CID	1983	Base; High performance	US1053H
				5.9L V8 360 CID	1975-1979	Air Pump	US1053
				5.9L V8 360 CID	1975-1979	Air Pump, High performance	US1053H
				5.9L V8 360 CID	1980	300, Base, Crown, LS	US1053

WATER PUMPS





# WATER PUMP APPLICATION GUIDE



Engine	Years	Application Description	USMW	Engine	Years	Application Description	USMW
<b>CHRYSLER (cont'd.)</b>				<b>CHRYSLER (cont'd.)</b>			
<b>CORDOBA (cont'd.)</b>				<b>LEBARON (cont'd.)</b>			
5.9L V8 360 CID	1980	300, Base, Crown, LS; High performance	US1053H	3.0L V6 2972cc 181 CID	1992	Base, GTC, Landau, LX; With back plate housing	US7121-2
5.9L V8 360 CID	1981-1982		US1053	3.0L V6 2972cc 181 CID	1993	Base, GTC, Landau, LE, LX	US7121
5.9L V8 360 CID	1981-1982	High performance	US1053H	3.0L V6 2972cc 181 CID	1993	Base, GTC, Landau, LE, LX; With back plate housing	US7121-2
5.9L V8 5900cc 360 CID	1980-1982	Mexican Application	US1053	3.0L V6 2972cc 181 CID	1994	GTC, Landau, LE	US7121
6.6L V8 400 CID	1975-1978		US1040	3.0L V6 2972cc 181 CID	1994	GTC, Landau, LE; With back plate housing	US7121-2
<b>CROSSFIRE</b>				<b>LHS</b>			
3.2L V6 3199cc	2005-2006	SRT-6	US9379	3.0L V6 2972cc 181 CID	1995	GTC	US7121
3.2L V6 3200cc 195 CID	2004	Base	US9379	3.0L V6 2972cc 181 CID	1995	GTC; With back plate housing	US7121-2
3.2L V6 3200cc 195 CID	2005-2007	Base, Limited	US9379	3.7L L6 3687cc 225 CID	1978-1979		US7100
3.2L V6 3200cc 195 CID	2008	Limited	US9379	3.7L L6 3687cc 225 CID	1980-1981	Base, Medallion, Salon, Special	US7100
<b>DART</b>				<b>MAGNUM</b>			
2.2L L4 2200cc 135 CID	1986-1988	Mexican Application	US7110	2.5L L4 2507cc 153 CID	1987-1988	Mexican Application	US7110
2.2L L4 2200cc 135 CID	1989	Mexican Application	US7122	<b>NEWPORT</b>			
<b>E CLASS</b>				<b>NEW YORKER</b>			
2.2L L4 135 CID	1983-1984	Base	US7110	2.2L L4 135 CID	1983-1987	Base	US7110
2.2L L4 135 CID	1983-1984	Base; High performance	US7110H	2.2L L4 135 CID	1983-1987	Base; High performance	US7110H
2.6L L4 2555cc 156 CID	1983-1984	Base	US7111	2.2L L4 135 CID	1988	High performance	US7110H
<b>EXECUTIVE LIMOUSINE</b>				<b>PACIFICA</b>			
2.6L L4 2555cc 156 CID	1985	Base	US7111	3.5L V6 3497cc 215 CID	2004	Base	US7162
<b>EXECUTIVE SEDAN</b>				<b>NEW YORKER</b>			
2.6L L4 2555cc 156 CID	1983-1984	Base	US7111	3.5L V6 3497cc 215 CID	2005-2006	Base, Limited, Touring	US8951
<b>FIFTH AVENUE</b>				<b>NEW YORKER</b>			
3.7L L6 3687cc 225 CID	1983	Base	US7100	3.6L V6 3604cc 220 CID	2017	Hybrid Platinum, Hybrid Premium, Limited, LX, Touring, Touring L, Touring L Plus	US8151
5.2L V8 318 CID	1983-1989	Base	US1053	3.6L V6 3604cc 220 CID	2018	Hybrid Limited, Hybrid Touring L, Hybrid Touring Plus, L, Limited, LX, Touring, Touring L, Touring L Plus	US8151
5.2L V8 318 CID	1983-1989	Base; High performance	US1053H	3.8L V6 230 CID	2005	Base	US8968
<b>GRAND VOYAGER</b>				<b>NEW YORKER</b>			
3.0L V6 2972cc 181 CID	2000	Base, SE	US7121	3.8L V6 230 CID	2007	Base	US8968
3.0L V6 2972cc 181 CID	2000	Base, SE; With back plate housing	US7121-2	3.8L V6 230 CID	2008	LX	US8968
3.3L V6 3294cc 201 CID	2001	Mexican Application	US7165	<b>PACIFICA</b>			
3.3L V6 3301cc 201 CID	2000	Base, SE	US7126	3.5L V6 3497cc 215 CID	2004	Base	US7162
3.8L V6 3800cc 231 CID	1991-1995	Mexican Application	US7126	3.5L V6 3497cc 215 CID	2005-2006	Base, Limited, Touring	US8951
3.8L V6 3800cc 232 CID	1998-2001	Mexican Application	US7126	3.6L V6 3604cc 220 CID	2017	Hybrid Platinum, Hybrid Premium, Limited, LX, Touring, Touring L, Touring L Plus	US8151
3.8L V6 3800cc 232 CID	2002	Mexican Application	US7165	3.6L V6 3604cc 220 CID	2018	Hybrid Limited, Hybrid Touring L, Hybrid Touring Plus, L, Limited, LX, Touring, Touring L, Touring L Plus	US8151
<b>IMPERIAL</b>				<b>PACIFICA</b>			
3.3L V6 3301cc 201 CID	1990-1991	Base	US7126	3.8L V6 230 CID	2005	Base	US8968
3.8L V6 230 CID	1991-1993	Base	US7126	3.8L V6 230 CID	2007	Base	US8968
5.2L V8 318 CID	1981-1983	Base	US1053	3.8L V6 230 CID	2008	LX	US8968
5.2L V8 318 CID	1981-1983	Base; High performance	US1053H	<b>PACIFICA</b>			
7.2L V8 440 CID	1975		US1040	3.5L V6 3497cc 215 CID	2004	Base	US7162
<b>LASER</b>				<b>PACIFICA</b>			
2.2L L4 135 CID	1984-1986	Base, XE	US7110	3.5L V6 3497cc 215 CID	2005-2006	Base, Limited, Touring	US8951
2.2L L4 135 CID	1984-1986	Base, XE; High performance	US7110H	3.6L V6 3604cc 220 CID	2017	Hybrid Platinum, Hybrid Premium, Limited, LX, Touring, Touring L, Touring L Plus	US8151
2.5L L4 2507cc 153 CID	1986	Base, XE	US7110	3.6L V6 3604cc 220 CID	2018	Hybrid Limited, Hybrid Touring L, Hybrid Touring Plus, L, Limited, LX, Touring, Touring L, Touring L Plus	US8151
2.5L L4 2507cc 153 CID	1986	Base, XE; High performance	US7110H	3.8L V6 230 CID	2005	Base	US8968
<b>LEBARON</b>				<b>PACIFICA</b>			
2.2L L4 135 CID	1982	Base, Medallion	US7110	3.8L V6 230 CID	2007	Base	US8968
2.2L L4 135 CID	1982	Base, Medallion; High performance	US7110H	3.8L V6 230 CID	2008	LX	US8968
2.2L L4 135 CID	1983-1984	Base, Mark Cross	US7110	<b>PACIFICA</b>			
2.2L L4 135 CID	1983-1984	Base, Mark Cross; High performance	US7110H	3.5L V6 3497cc 215 CID	2004	Base	US7162
2.2L L4 135 CID	1985-1986	Base, GTS, Mark Cross	US7110	3.5L V6 3497cc 215 CID	2005-2006	Base, Limited, Touring	US8951
2.2L L4 135 CID	1985-1986	Base, GTS, Mark Cross; High performance	US7110H	3.6L V6 3604cc 220 CID	2017	Hybrid Platinum, Hybrid Premium, Limited, LX, Touring, Touring L, Touring L Plus	US8151
2.2L L4 135 CID	1987-1988	Base, GTS, Premium	US7110	3.6L V6 3604cc 220 CID	2018	Hybrid Limited, Hybrid Touring L, Hybrid Touring Plus, L, Limited, LX, Touring, Touring L, Touring L Plus	US8151
2.2L L4 135 CID	1987-1988	Base, GTS, Premium; High performance	US7110H	3.8L V6 230 CID	2005	Base	US8968
2.2L L4 135 CID	1989	Base, GTS, Premium	US7122	3.8L V6 230 CID	2007	Base	US8968
2.2L L4 135 CID	1990	GTC	US7127	3.8L V6 230 CID	2008	LX	US8968
2.2L L4 2200cc 135 CID	1982-1987	Mexican Application	US7110	<b>PACIFICA</b>			
2.5L L4 2500cc 153 CID	1993-1995	Mexican Application	US7127	3.5L V6 3497cc 215 CID	2004	Base	US7162
2.5L L4 2507cc 153 CID	1986	Base, GTS, Mark Cross	US7110	3.5L V6 3497cc 215 CID	2005-2006	Base, Limited, Touring	US8951
2.5L L4 2507cc 153 CID	1986	Base, GTS, Mark Cross; High performance	US7110H	3.6L V6 3604cc 220 CID	2017	Hybrid Platinum, Hybrid Premium, Limited, LX, Touring, Touring L, Touring L Plus	US8151
2.5L L4 2507cc 153 CID	1987-1988	Base, GTS, Premium	US7110	3.6L V6 3604cc 220 CID	2018	Hybrid Limited, Hybrid Touring L, Hybrid Touring Plus, L, Limited, LX, Touring, Touring L, Touring L Plus	US8151
2.5L L4 2507cc 153 CID	1987-1988	Base, GTS, Premium; High performance	US7110H	3.8L V6 230 CID	2005	Base	US8968
2.5L L4 2507cc 153 CID	1989	Base, GT, GTC, GTS, High Line, Premium	US7122	3.8L V6 230 CID	2007	Base	US8968
2.5L L4 2507cc 153 CID	1990	Base, GT, GTC, High Line, Premium	US7127	3.8L V6 230 CID	2008	LX	US8968
2.5L L4 2507cc 153 CID	1991	Base, GTC	US7127	<b>PACIFICA</b>			
2.5L L4 2507cc 153 CID	1992	Base, GTC, Landau	US7127	3.5L V6 3497cc 215 CID	2004	Base	US7162
2.5L L4 2507cc 153 CID	1993	Base, LE	US7127	3.5L V6 3497cc 215 CID	2005-2006	Base, Limited, Touring	US8951
2.6L L4 2555cc 156 CID	1982	Base, Medallion	US7111	3.6L V6 3604cc 220 CID	2017	Hybrid Platinum, Hybrid Premium, Limited, LX, Touring, Touring L, Touring L Plus	US8151
2.6L L4 2555cc 156 CID	1983-1985	Base, Mark Cross	US7111	3.6L V6 3604cc 220 CID	2018	Hybrid Limited, Hybrid Touring L, Hybrid Touring Plus, L, Limited, LX, Touring, Touring L, Touring L Plus	US8151
3.0L V6 2972cc 181 CID	1990	Base, GT, High Line, Premium	US7121	3.8L V6 230 CID	2005	Base	US8968
3.0L V6 2972cc 181 CID	1991	Base, GT, High Line, Premium; With back plate housing	US7121-2	3.8L V6 230 CID	2007	Base	US8968
3.0L V6 2972cc 181 CID	1991	Base, GTC, LX	US7121	3.8L V6 230 CID	2008	LX	US8968
3.0L V6 2972cc 181 CID	1991	Base, GTC, LX; With back plate housing	US7121-2	<b>PACIFICA</b>			
3.0L V6 2972cc 181 CID	1992	Base, GTC, Landau, LX	US7121	3.5L V6 3497cc 215 CID	2004	Base	US7162

Engine	Years	Application Description	USMW	Engine	Years	Application Description	USMW
<b>CHRYSLER (cont'd.)</b>				<b>CHRYSLER (cont'd.)</b>			
<b>PACIFICA (cont'd.)</b>				<b>TOWN &amp; COUNTRY (cont'd.)</b>			
4.0L V6 3952cc 241 CID	2007	Base, Limited, Touring	US8951	2.5L L4 2507cc 153 CID	1987-1988	Base	US7110
4.0L V6 3952cc 241 CID	2008	Limited, LX, Touring	US8951	2.5L L4 2507cc 153 CID	1987-1988	Base; High performance	US7110H
<b>PHANTOM</b>				2.6L L4 2555cc 156 CID	1982	Base	US7111
2.2L L4 2200cc 135 CID	1987-1990	Mexican Application	US7110	2.6L L4 2555cc 156 CID	1984-1985	Base, Mark Cross	US7111
2.2L L4 2200cc 135 CID	1989	Mexican Application	US7122	3.3L V6 3301cc 201 CID	1990-1993	Base	US7126
2.2L L4 2200cc 135 CID	1990	Mexican Application	US7127	3.3L V6 3301cc 201 CID	1996	Base, LX	US7126
2.2L L4 2200cc 135 CID	1992-1994	Mexican Application	US7110	3.3L V6 3301cc 201 CID	1997-1998	LX, SX	US7126
2.5L L4 2500cc 153 CID	1990-1994	Mexican Application	US7127	3.3L V6 3301cc 201 CID	1999	LX, LXi, SX	US7126
<b>PROWLER</b>				3.3L V6 3301cc 201 CID	2000	LX, LXi	US7126
3.5L V6 3497cc 215 CID	2001-2002	Base	US7162	3.3L V6 3301cc 201 CID	2001	LX, LXi	US7165
<b>PT CRUISER</b>				3.3L V6 3301cc 201 CID	2002	EL, LX, LXi	US7165
2.4L L4 2429cc 148 CID	2001	Base, Limited, Touring	US7156	3.3L V6 3301cc 201 CID	2003	Base, EL, EX, Limited, LX, LXi	US7165
2.4L L4 2429cc 148 CID	2002	Base, Dream, Limited, Touring	US7156	3.3L V6 3301cc 201 CID	2004	Base, LX	US7165
2.4L L4 2429cc 148 CID	2003	Base, Limited, Touring	US7156	3.3L V6 3301cc 201 CID	2005	Base, Limited, LX, Touring	US7165
2.4L L4 2429cc 148 CID	2003-2004	GT	US7167	3.3L V6 3301cc 201 CID	2006-2007	Base, LX	US7165
2.4L L4 2429cc 148 CID	2004	Base	US7156	3.3L V6 3301cc 201 CID	2008-2010	LX	US6231
2.4L L4 2429cc 148 CID	2004-2007	Limited, Touring; Naturally Aspirated	US7156	3.6L V6 3604cc 220 CID	2011-2012	Limited, Touring, Touring L	US8981
2.4L L4 2429cc 148 CID	2004-2007	Limited, Touring; Turbocharged	US7167	3.6L V6 3604cc 220 CID	2011-2013	Mexican Application	US8981
2.4L L4 2429cc 148 CID	2005	Dream Cruiser, GT, Street Cruiser	US7167	3.6L V6 3604cc 220 CID	2013	Limited, S, Touring, Touring L	US8981
2.4L L4 2429cc 148 CID	2006	Base, Street Cruiser	US7156	3.6L V6 3604cc 220 CID	2014	30th Anniversary Edition, Limited, S, Touring, Touring L	US8981
2.4L L4 2429cc 148 CID	2006-2007	GT	US7167	3.6L V6 3604cc 220 CID	2015	Limited, LX, S, Touring, Touring L	US8981
2.4L L4 2429cc 148 CID	2007	Base	US7156	3.6L V6 3604cc 220 CID	2016	Limited, Limited Platinum, LX, S, Touring, Touring L	US8981
2.4L L4 2429cc 148 CID	2008	Base, LX	US7156	3.6L V6 3605cc 220 CID	2014-2015	Mexican Application	US8981
2.4L L4 2429cc 148 CID	2008	Base, Touring; Naturally Aspirated	US7156	3.7L L6 3687cc 225 CID	1978-1979		US7100
2.4L L4 2429cc 148 CID	2008	Base, Touring; Turbocharged	US7167	3.7L L6 3687cc 225 CID	1980-1981	Base	US7100
2.4L L4 2429cc 148 CID	2008-2009	Limited	US7167	3.8L V6 230 CID	1994-1995	Base	US7126
2.4L L4 2429cc 148 CID	2009	Base, LX, Touring	US7156	3.8L V6 230 CID	1996	Base, LX, LXi	US7126
2.4L L4 2429cc 148 CID	2010	Classic, Couture Edition	US7156	3.8L V6 230 CID	1997-1999	LX, LXi, SX	US7126
<b>SEBRING</b>				3.8L V6 230 CID	1999	Limited; (L)	US7126
2.0L L4 1996cc 122 CID	1995-1999	LX	US7150	3.8L V6 230 CID	2000	Limited, LX, LXi	US7126
2.4L L4 2351cc	2001-2003	LX	US9399	3.8L V6 230 CID	2001	EX, Limited	US7165
2.4L L4 2351cc	2004-2005	Base	US9399	3.8L V6 230 CID	2002-2003	EL, EX, Limited, LX, LXi	US7165
2.4L L4 2360cc 144 CID	2007	Base, Limited, Touring	US6038	3.8L V6 230 CID	2004	EX, Limited, Touring	US7165
2.4L L4 2360cc 144 CID	2008-2010	Limited, LX, Touring	US6038	3.8L V6 230 CID	2005	Limited, LX, Touring	US7165
2.4L L4 2429cc 148 CID	1996	JX; Hydraulic Tensioner	US7153	3.8L V6 230 CID	2006-2007	Limited, Touring	US7165
2.4L L4 2429cc 148 CID	1996	JX; Mechanical Tensioner	US7156	3.8L V6 230 CID	2008	Touring	US6231
2.4L L4 2429cc 148 CID	1997-1998	JX, JXi	US7156	3.8L V6 3778cc 231 CID	2009	Touring	US6231
2.4L L4 2429cc 148 CID	2001-2003	LX	US7156	3.8L V6 3778cc 231 CID	2010	Touring, Walter P. Chrysler Signature Series	US6231
2.4L L4 2429cc 148 CID	2004	Base, LX	US7156	3.8L V6 3800cc 231 CID	2010	LX	US6231
2.4L L4 2429cc 148 CID	2005-2006	Base	US7156	4.0L V6 3952cc 241 CID	2008-2009	Limited	US8951
2.5L V6 2497cc 152 CID	1995	LX, LXi	US7152	4.0L V6 3952cc 241 CID	2010	Limited, Touring	US8951
2.5L V6 2497cc 152 CID	1996-2000	JX, JXi, LX, LXi	US7152	5.2L V8 318 CID	1978-1979	Air Pump	US1053
2.7L V6 2736cc 167 CID	2001	LX, LXi, LXi Limited	US7161	5.2L V8 318 CID	1978-1979	Air Pump, High performance	US1053H
2.7L V6 2736cc 167 CID	2002-2003	GTC, Limited, LX, LXi	US7161	5.2L V8 318 CID	1980-1981	Base	US1053
2.7L V6 2736cc 167 CID	2004	Base, GTC, Limited, Touring	US7161	5.2L V8 318 CID	1980-1981	Base; High performance	US1053H
2.7L V6 2736cc 167 CID	2005-2006	GTC, Limited, Touring, TSi	US7161	5.9L V8 360 CID	1978-1979	Air Pump	US1053
2.7L V6 2736cc 167 CID	2007	Base, Touring	US7161	5.9L V8 360 CID	1978-1979	Air Pump, High performance	US1053H
2.7L V6 2736cc 167 CID	2008	Touring	US6217	<b>VOLARE</b>			
2.7L V6 2736cc 167 CID	2009-2010	LX, Touring	US6217	3.7L L6 3700cc 225 CID	1986-1989	Mexican Application	US7100
3.0L V6 2972cc 181 CID	2001-2002	LX, LXi	US7152	<b>VOYAGER</b>			
3.0L V6 2972cc 181 CID	2003	LX	US7152	2.4L L4 2426cc 148 CID	1996-1997	Mexican Application	US7156
3.0L V6 2972cc 181 CID	2004-2005	Limited	US7152	2.4L L4 2429cc 148 CID	2000-2001	Base	US7156
3.5L V6 3497cc 215 CID	2007-2010	Limited	US8951	2.4L L4 2429cc 148 CID	2002	Base, LX	US7156
<b>SHADOW</b>				2.4L L4 2429cc 148 CID	2003	LX	US7156
2.2L L4 2212cc 135 CID	1989	Mexican Application	US7122	2.5L L4 2507cc 153 CID	1990-1995	Mexican Application	US7127
2.2L L4 2212cc 135 CID	1990-1991	Mexican Application	US7127	3.0L V6 2966cc 181 CID	1992-1994	Mexican Application	US7121
2.5L L4 2507cc 153 CID	1988	Mexican Application	US7110	3.0L V6 2966cc 181 CID	1996-1997	Mexican Application	US7121
2.5L L4 2507cc 153 CID	1989	Mexican Application	US7122	3.0L V6 2972cc 181 CID	2000	Base	US7121
2.5L L4 2507cc 153 CID	1990-1994	Mexican Application	US7127	3.0L V6 2972cc 181 CID	2000	Base; With back plate housing	US7121-2
3.0L V6 2966cc 181 CID	1992	Mexican Application	US7121	3.3L V6 3294cc 201 CID	1993-1999	Mexican Application	US7126
<b>SPIRIT</b>				3.3L V6 3294cc 201 CID	2001-2002	Mexican Application	US7165
2.5L L4 2507cc 153 CID	1989	Mexican Application	US7122	3.3L V6 3294cc 201 CID	2004-2008	Mexican Application	US7165
2.5L L4 2507cc 153 CID	1990-1995	Mexican Application	US7127	3.3L V6 3301cc 201 CID	2000	Base, SE	US7126
3.0L V6 2966cc 181 CID	1989-1992	Mexican Application	US7121	3.3L V6 3301cc 201 CID	2001-2002	Base, LX	US7165
<b>STRATUS</b>				3.3L V6 3301cc 201 CID	2003	LX	US7165
2.4L L4 2429cc 148 CID	1996-1997	Mexican Application	US7156	<b>DAEWOO</b>			
<b>TC MASERATI</b>				<b>LANOS</b>			
2.2L L4 135 CID	1989	Base	US7122	1.6L L4 1588cc 98 CID	1999-2000	S, SE, SX	US8917
2.2L L4 135 CID	1990	Base	US7110	1.6L L4 1588cc 98 CID	2001-2002	S, Sport	US8917
2.2L L4 135 CID	1990	Base; High performance	US7110H	<b>LEGANZA</b>			
3.0L V6 2972cc 181 CID	1990-1991	Base	US7121	2.2L L4 2200cc	1999-2001	CDX, SE, SX	US9375
3.0L V6 2972cc 181 CID	1990-1991	Base; With back plate housing	US7121-2	2.2L L4 2200cc	2002	CDX, SE	US9375
<b>TOWN &amp; COUNTRY</b>				<b>NUBIRA</b>			
2.2L L4 135 CID	1982	Base	US7110	2.0L L4 1998cc	1999	CDX, SX	US9375
2.2L L4 135 CID	1982	Base; High performance	US7110H	2.0L L4 1998cc	2000-2002	CDX, SE	US9375
2.2L L4 135 CID	1983-1986	Base, Mark Cross	US7110	<b>DAIHATSU</b>			
2.2L L4 135 CID	1983-1986	Base, Mark Cross; High performance	US7110H	<b>CHARADE</b>			
2.2L L4 135 CID	1987-1988	Base	US7110	1.0L L3 993cc 61 CID	1988	CLS, CLX, CSX	US9238
2.2L L4 135 CID	1987-1988	Base; High performance	US7110H	1.0L L3 993cc 61 CID	1989	CES, CLS, CLX	US9238
2.5L L4 2507cc 153 CID	1986	Base, Mark Cross	US7110				
2.5L L4 2507cc 153 CID	1986	Base, Mark Cross; High performance	US7110H				

WATER PUMPS

Engine	Years	Application Description	USMW
<b>DAIHATSU (cont'd.)</b>			
<b>CHARADE (cont'd.)</b>			
1.0L L3 993cc 61 CID	1990	SE, SX	<b>US9238</b>
1.0L L3 993cc 61 CID	1991-1992	SE	<b>US9238</b>
1.3L L4 1295cc	1989	CLS, CLX	<b>US9237</b>
1.3L L4 1295cc	1990-1992	SE, SX	<b>US9237</b>
<b>ROCKY</b>			
1.6L L4 1589cc	1990-1992	SE, SX	<b>US8908</b>
<b>DODGE</b>			
<b>330</b>			
4.5L V8 4473cc 273 CID	1964		<b>US919</b>
5.2L V8 5212cc 318 CID	1963-1964		<b>US919</b>
<b>400</b>			
2.2L L4 135 CID	1982	Base, LS	<b>US7110</b>
2.2L L4 135 CID	1982	Base, LS; High performance	<b>US7110H</b>
2.2L L4 135 CID	1983	Base	<b>US7110</b>
2.2L L4 135 CID	1983	Base; High performance	<b>US7110H</b>
2.6L L4 2555cc 156 CID	1982	Base, LS	<b>US7111</b>
2.6L L4 2555cc 156 CID	1983	Base	<b>US7111</b>
<b>440</b>			
5.2L V8 5212cc 318 CID	1963-1964		<b>US919</b>
<b>600</b>			
2.2L L4 135 CID	1983	Base, ES	<b>US7110</b>
2.2L L4 135 CID	1983	Base, ES; High performance	<b>US7110H</b>
2.2L L4 135 CID	1984	Base	<b>US7110</b>
2.2L L4 135 CID	1984	Base; High performance	<b>US7110H</b>
2.2L L4 135 CID	1985	Base, ES, SE	<b>US7110</b>
2.2L L4 135 CID	1985	Base, ES, SE; High performance	<b>US7110H</b>
2.2L L4 135 CID	1986-1988	Base, SE	<b>US7110</b>
2.2L L4 135 CID	1986-1988	Base, SE; High performance	<b>US7110H</b>
2.5L L4 2507cc 153 CID	1986-1988	Base, SE	<b>US7110</b>
2.5L L4 2507cc 153 CID	1986-1988	Base, SE; High performance	<b>US7110H</b>
2.6L L4 2555cc 156 CID	1983-1984	Base, ES	<b>US7111</b>
2.6L L4 2555cc 156 CID	1985	Base, SE	<b>US7111</b>
<b>A100</b>			
4.5L V8 4473cc 273 CID	1964-1966		<b>US919</b>
<b>A100 TRUCK</b>			
4.5L V8 273 CID	1964-1967		<b>US919</b>
5.2L V8 318 CID	1967-1969		<b>US919</b>
<b>ARIES</b>			
2.2L L4 135 CID	1981-1984	Base, Custom, SE	<b>US7110</b>
2.2L L4 135 CID	1981-1984	Base, Custom, SE; High performance	<b>US7110H</b>
2.2L L4 135 CID	1985-1986	Base, LE, SE	<b>US7110</b>
2.2L L4 135 CID	1985-1986	Base, LE, SE; High performance	<b>US7110H</b>
2.2L L4 135 CID	1987	Base, LE	<b>US7110</b>
2.2L L4 135 CID	1987	Base, LE; High performance	<b>US7110H</b>
2.2L L4 135 CID	1988	America	<b>US7110</b>
2.2L L4 135 CID	1988	America; High performance	<b>US7110H</b>
2.2L L4 135 CID	1989	America	<b>US7122</b>
2.5L L4 2507cc 153 CID	1986	LE, SE	<b>US7110</b>
2.5L L4 2507cc 153 CID	1986	LE, SE; High performance	<b>US7110H</b>
2.5L L4 2507cc 153 CID	1987	LE	<b>US7110</b>
2.5L L4 2507cc 153 CID	1987	LE; High performance	<b>US7110H</b>
2.5L L4 2507cc 153 CID	1988	America	<b>US7110</b>
2.5L L4 2507cc 153 CID	1988	America; High performance	<b>US7110H</b>
2.5L L4 2507cc 153 CID	1989	America	<b>US7122</b>
2.6L L4 2555cc 156 CID	1981-1984	Base, Custom, SE	<b>US7111</b>
2.6L L4 2555cc 156 CID	1985	LE, SE	<b>US7111</b>
<b>ASPEN</b>			
3.7L L6 3687cc 225 CID	1976-1979		<b>US7100</b>
3.7L L6 3687cc 225 CID	1980	Base	<b>US7100</b>
5.2L V8 318 CID	1976-1978	Exc.Air Pump	<b>US1053</b>
5.2L V8 318 CID	1976-1978	Exc.Air Pump, High performance	<b>US1053H</b>
5.2L V8 318 CID	1976-1979	Air Pump	<b>US1053</b>
5.2L V8 318 CID	1976-1979	Air Pump, High performance	<b>US1053H</b>
5.2L V8 318 CID	1980	Base	<b>US1053</b>
5.2L V8 318 CID	1980	Base; High performance	<b>US1053H</b>
5.9L V8 360 CID	1976-1978	Exc.Air Pump	<b>US1053</b>
5.9L V8 360 CID	1976-1978	Exc.Air Pump, High performance	<b>US1053H</b>
5.9L V8 360 CID	1976-1979	Air Pump	<b>US1053</b>
5.9L V8 360 CID	1976-1979	Air Pump, High performance	<b>US1053H</b>
5.9L V8 360 CID	1980	Base	<b>US1053</b>
5.9L V8 360 CID	1980	Base; High performance	<b>US1053H</b>
<b>ATOS</b>			
1.0L L4 1000cc 61 CID	2001-2004		<b>US8935</b>
1.1L L4 1086cc 66 CID	2005-2012		<b>US8935</b>
<b>ATTITUDE</b>			
1.2L L3 1193cc 73 CID	2015-2018	SE, SXT	<b>US8143</b>
1.4L L4 1388cc 85 CID	2006-2010	Mexican Application	<b>US7115</b>
1.4L L4 1399cc 85 CID	2011	Mexican Application	<b>US7115</b>
1.6L L4 1598cc 97 CID	2006-2010	Mexican Application	<b>US9364</b>

Engine	Years	Application Description	USMW
<b>DODGE (cont'd.)</b>			
<b>ATTITUDE (cont'd.)</b>			
1.6L L4 1599cc 98 CID	2011	Mexican Application	<b>US9364</b>
1.6L L4 1599cc 98 CID	2012	Mexican Application	<b>US7115</b>
<b>AVENGER</b>			
2.0L L4 1996cc 122 CID	1995	Base	<b>US7150</b>
2.0L L4 1996cc 122 CID	1996-1999	Base, ES	<b>US7150</b>
2.0L L4 2000cc 122 CID	2008-2010	Mexican Application	<b>US6038</b>
2.4L L4 2360cc 144 CID	2008-2009	SE, SXT	<b>US6038</b>
2.4L L4 2360cc 144 CID	2010	Express, R/T, SXT	<b>US6038</b>
2.4L L4 2360cc 144 CID	2010-2011	Mexican Application	<b>US6038</b>
2.4L L4 2360cc 144 CID	2011	Express, Lux, Mainstreet	<b>US6038</b>
2.4L L4 2360cc 144 CID	2012-2014	SE, SXT	<b>US6038</b>
2.4L L4 2360cc 144 CID	2013-2014	Mexican Application	<b>US6038</b>
2.5L V6 2497cc 152 CID	1995-1996	ES	<b>US7152</b>
2.5L V6 2497cc 152 CID	1997-2000	Base, ES	<b>US7152</b>
2.7L V6 2736cc 167 CID	2008-2009	SE, SXT	<b>US6217</b>
2.7L V6 2736cc 167 CID	2010	R/T, SXT	<b>US6217</b>
3.5L V6 3497cc 215 CID	2008-2010	R/T	<b>US8951</b>
3.6L V6 3604cc 220 CID	2011	Express, Heat, Lux, Mainstreet	<b>US8981</b>
3.6L V6 3604cc 220 CID	2012	R/T, SE, SXT Plus	<b>US8981</b>
3.6L V6 3604cc 220 CID	2013-2014	R/T, SE, SXT	<b>US8981</b>
<b>B100</b>			
3.7L L6 3687cc 225 CID	1975-1979		<b>US7100</b>
3.7L L6 3687cc 225 CID	1980	Base	<b>US7100</b>
5.2L V8 5211cc 318 CID	1975-1978	Exc.Air Pump	<b>US1053</b>
5.2L V8 5211cc 318 CID	1975-1978	Exc.Air Pump, High performance	<b>US1053H</b>
5.2L V8 5211cc 318 CID	1975-1979	Air Pump	<b>US1053</b>
5.2L V8 5211cc 318 CID	1975-1979	Air Pump, High performance	<b>US1053H</b>
5.2L V8 5211cc 318 CID	1980	Base	<b>US1053</b>
5.2L V8 5211cc 318 CID	1980	Base; High performance	<b>US1053H</b>
5.9L V8 360 CID	1976-1978	Air Pump	<b>US1053</b>
5.9L V8 360 CID	1976-1978	Exc.Air Pump	<b>US1053</b>
5.9L V8 360 CID	1976-1978	Air Pump, High performance	<b>US1053H</b>
5.9L V8 360 CID	1976-1978	Exc.Air Pump, High performance	<b>US1053H</b>
<b>B150</b>			
3.7L L6 3687cc 225 CID	1981-1987	Base	<b>US7100</b>
3.9L V6 3906cc 239 CID	1988-1991	Base	<b>US1053</b>
3.9L V6 3906cc 239 CID	1988-1991	Base; High performance	<b>US1053H</b>
3.9L V6 3906cc 239 CID	1992	Base	<b>US7159</b>
3.9L V6 3906cc 239 CID	1993-1994	Base	<b>US7160</b>
5.2L V8 5211cc 318 CID	1981-1991	Base	<b>US1053</b>
5.2L V8 5211cc 318 CID	1981-1991	Base; High performance	<b>US1053H</b>
5.2L V8 5211cc 318 CID	1992	Base	<b>US7159</b>
5.2L V8 5211cc 318 CID	1993-1994	Base	<b>US7160</b>
<b>B200</b>			
3.7L L6 225 CID	1979		<b>US7100</b>
3.7L L6 3687cc 225 CID	1975-1978		<b>US7100</b>
3.7L L6 3687cc 225 CID	1980	Base	<b>US7100</b>
5.2L V8 5211cc 318 CID	1975-1978	Exc.Air Pump	<b>US1053</b>
5.2L V8 5211cc 318 CID	1975-1978	Exc.Air Pump, High performance	<b>US1053H</b>
5.2L V8 5211cc 318 CID	1975-1979	Air Pump	<b>US1053</b>
5.2L V8 5211cc 318 CID	1975-1979	Air Pump, High performance	<b>US1053H</b>
5.2L V8 5211cc 318 CID	1980	Base	<b>US1053</b>
5.2L V8 5211cc 318 CID	1980	Base; High performance	<b>US1053H</b>
5.9L V8 360 CID	1975-1978	Exc.Air Pump	<b>US1053</b>
5.9L V8 360 CID	1975-1978	Exc.Air Pump, High performance	<b>US1053H</b>
5.9L V8 360 CID	1975-1979	Air Pump	<b>US1053</b>
5.9L V8 360 CID	1975-1979	Air Pump, High performance	<b>US1053H</b>
5.9L V8 360 CID	1980	Base	<b>US1053</b>
5.9L V8 360 CID	1980	Base; High performance	<b>US1053H</b>
6.6L V8 400 CID	1976-1978		<b>US1040</b>
7.2L V8 440 CID	1975-1978		<b>US1040</b>
<b>B250</b>			
3.7L L6 3687cc 225 CID	1981-1987	Base	<b>US7100</b>
3.9L V6 3906cc 239 CID	1988-1991	Base	<b>US1053</b>
3.9L V6 3906cc 239 CID	1988-1991	Base; High performance	<b>US1053H</b>
3.9L V6 3906cc 239 CID	1992	Base	<b>US7159</b>
3.9L V6 3906cc 239 CID	1993-1994	Base	<b>US7160</b>
5.2L V8 5211cc 318 CID	1981-1991	Base	<b>US1053</b>
5.2L V8 5211cc 318 CID	1981-1991	Base; High performance	<b>US1053H</b>
5.2L V8 5211cc 318 CID	1992	Base	<b>US7159</b>
5.2L V8 5211cc 318 CID	1993-1994	Base	<b>US7160</b>
5.9L V8 360 CID	1981	Base	<b>US1053</b>
5.9L V8 360 CID	1981	Base; High performance	<b>US1053H</b>
5.9L V8 360 CID	1984-1992	Base	<b>US1053</b>
5.9L V8 360 CID	1984-1992	Base; High performance	<b>US1053H</b>
5.9L V8 360 CID	1993-1994	Base	<b>US7160</b>
<b>B300</b>			
3.7L L6 225 CID	1980	Base	<b>US7100</b>
3.7L L6 3687cc 225 CID	1975-1979		<b>US7100</b>
5.2L V8 5211cc 318 CID	1975-1978	Exc.Air Pump	<b>US1053</b>
5.2L V8 5211cc 318 CID	1975-1978	Exc.Air Pump, High performance	<b>US1053H</b>
5.2L V8 5211cc 318 CID	1975-1979	Air Pump	<b>US1053</b>
5.2L V8 5211cc 318 CID	1975-1979	Air Pump, High performance	<b>US1053H</b>



Engine	Years	Application Description	USMW	Engine	Years	Application Description	USMW
<b>DODGE (cont'd.)</b>				<b>DODGE (cont'd.)</b>			
<b>B300 (cont'd.)</b>				<b>CARAVAN (cont'd.)</b>			
5.2L V8 5211cc 318 CID	1980	Base	US1053	3.3L V6 3301cc 201 CID	1991-1993	C/V, ES, LE, SE	US7126
5.2L V8 5211cc 318 CID	1980	Base; High performance	US1053H	3.3L V6 3301cc 201 CID	1994-1995	Base, C/V, ES, LE, SE	US7126
5.9L V8 360 CID	1975-1978	Exc.Air Pump	US1053	3.3L V6 3301cc 201 CID	1996	ES, LE, SE	US7126
5.9L V8 360 CID	1975-1978	Exc.Air Pump, High performance	US1053H	3.3L V6 3301cc 201 CID	1997	Base, ES, LE, SE	US7126
5.9L V8 360 CID	1975-1979	Air Pump	US1053	3.3L V6 3301cc 201 CID	1998-1999	Base, ES, LE, SE, Sport	US7126
5.9L V8 360 CID	1975-1979	Air Pump, High performance	US1053H	3.3L V6 3301cc 201 CID	2000	Base, SE, Sport	US7126
5.9L V8 360 CID	1980	Base	US1053	3.3L V6 3301cc 201 CID	2001-2002	SE, Sport	US7165
5.9L V8 360 CID	1980	Base; High performance	US1053H	3.3L V6 3301cc 201 CID	2003	C/V, SE, Sport	US7165
6.6L V8 400 CID	1976-1978		US1040	3.3L V6 3301cc 201 CID	2004	C/V, SXT	US7165
7.2L V8 440 CID	1975-1978		US1040	3.3L V6 3301cc 201 CID	2005	C/V, SE, SXT	US7165
<b>B350</b>				<b>CB300</b>			
5.2L V8 5211cc 318 CID	1981-1991	Base	US1053	3.3L V6 230 CID	1996-1997	ES, LE	US7126
5.2L V8 5211cc 318 CID	1981-1991	Base; High performance	US1053H	3.8L V6 230 CID	1998	Base, ES, LE, SE, Sport	US7126
5.2L V8 5211cc 318 CID	1992	Base	US7159	3.8L V6 230 CID	1999	ES, LE, SE, Sport	US7126
5.2L V8 5211cc 318 CID	1993-1994	Base	US7160	<b>CHALLENGER</b>			
5.9L V8 360 CID	1981-1992	Base	US1053	5.2L V8 5211cc 318 CID	1980	Base	US1053
5.9L V8 360 CID	1981-1992	Base; High performance	US1053H	5.2L V8 5211cc 318 CID	1980	Base; High performance	US1053H
5.9L V8 360 CID	1993-1994	Base	US7160	5.9L V8 360 CID	1980	Base	US1053
<b>B1500</b>				5.9L V8 360 CID	1980	Base; High performance	US1053H
3.9L V6 3906cc 239 CID	1995-1998	Base	US7160	<b>CHALLENGER</b>			
5.2L V8 5211cc 318 CID	1995-1998	Base	US7160	1.6L L4 1597cc 98 CID	1978-1979		US7105
5.9L V8 360 CID	1998	Base	US7160	2.6L L4 2555cc 156 CID	1978-1979		US7120
<b>B2500</b>				2.6L L4 2555cc 156 CID	1980-1983	Base, Premium	US7120
3.9L V6 3906cc 239 CID	1995-1997	Base	US7160	3.5L V6 3497cc 215 CID	2009-2010	SE	US8951
5.2L V8 5211cc 318 CID	1995-1998	Base	US7160	3.6L V6 3604cc 220 CID	2011	SE	US8981
5.9L V8 360 CID	1995-1998	Base	US7160	3.6L V6 3604cc 220 CID	2012	SXT, SXT Plus	US8981
<b>B3500</b>				3.6L V6 3604cc 220 CID	2013	SXT	US8981
5.2L V8 5211cc 318 CID	1995-1998	Base	US7160	3.6L V6 3604cc 220 CID	2013-2016	Mexican Application	US8981
5.9L V8 360 CID	1995-1998	Base	US7160	3.6L V6 3604cc 220 CID	2014	Rallye Redline, SXT	US8981
<b>CALIBER</b>				3.6L V6 3604cc 220 CID	2015-2016	SXT, SXT Plus	US8981
1.8L L4 1798cc 110 CID	2007-2009	SE, SXT	US6038	3.6L V6 3604cc 220 CID	2017-2018	GT, SXT, SXT Plus	US8981
2.0L L4 1998cc 122 CID	2007-2009	SE, SXT	US6038	5.7L V8 345 CID	2009-2010	R/T	US8979
2.0L L4 1998cc 122 CID	2010	Express, Heat, Mainstreet, SE, SXT, Uptown	US6038	5.7L V8 345 CID	2011	R/T	US8971
2.0L L4 1998cc 122 CID	2011	Express, Heat, Mainstreet, Uptown	US6038	5.7L V8 345 CID	2012	R/T, R/T Classic	US8971
2.0L L4 1998cc 122 CID	2012	SE, SXT, SXT Plus	US6038	5.7L V8 345 CID	2013	R/T; From 03/04/2013	US8115
2.4L L4 2360cc 144 CID	2007	R/T	US6038	5.7L V8 345 CID	2013	R/T; To 03/04/2013	US8971
2.4L L4 2360cc 144 CID	2008-2009	R/T, SRT-4	US6038	5.7L V8 345 CID	2013-2014	R/T	US8115
2.4L L4 2360cc 144 CID	2010	R/T, Rush	US6038	5.7L V8 345 CID	2015	R/T, R/T Plus	US8115
2.4L L4 2360cc 144 CID	2010-2011	Mexican Application	US6038	5.7L V8 345 CID	2016	R/T, R/T Plus, R/T Plus Shaker, R/T Shaker	US8115
2.4L L4 2360cc 144 CID	2011	Rush, Uptown	US6038	5.7L V8 345 CID	2017-2018	R/T, T/A	US8115
<b>CARAVAN</b>				6.1L V8 6059cc 370 CID	2008-2010	SRT8	US8940
2.2L L4 135 CID	1984-1987	Base, LE, SE	US7110	6.4L V8 6424cc 392 CID	2011-2013	SRT8	US8971
2.2L L4 135 CID	1984-1987	Base, LE, SE; High performance	US7110H	6.4L V8 6424cc 392 CID	2014	SRT8	US8115
2.4L L4 2429cc 148 CID	1996	Base, SE; Hydraulic Tensioner	US7153	6.4L V8 6424cc 392 CID	2015	Scat Pack, SRT 392	US8115
2.4L L4 2429cc 148 CID	1996	Base, SE; Mechanical Tensioner	US7156	6.4L V8 6424cc 392 CID	2016	392 Hemi Scat Pack Shaker, R/T Scat Pack, SRT 392	US8115
2.4L L4 2429cc 148 CID	1997	Base, SE	US7156	6.4L V8 6424cc 392 CID	2017-2018	R/T 392, SRT 392, T/A 392	US8115
2.4L L4 2429cc 148 CID	1998-1999	Base, ES	US7156	<b>CHARGER</b>			
2.4L L4 2429cc 148 CID	2000	Base	US7156	1.6L L4 1595cc 97 CID	1984	Base	US7113
2.4L L4 2429cc 148 CID	2001	SE	US7156	2.2L L4 135 CID	1984	Shelby	US7110
2.4L L4 2429cc 148 CID	2002	Ec, SE	US7156	2.2L L4 135 CID	1985-1986	2.2, Shelby	US7110
2.4L L4 2429cc 148 CID	2003-2007	SE	US7156	2.2L L4 135 CID	1985-1986	2.2, Shelby; High performance	US7110H
2.5L L4 2507cc 153 CID	1988	Base, LE, SE	US7110	2.2L L4 135 CID	1987	Base, Shelby	US7110
2.5L L4 2507cc 153 CID	1988	Base, LE, SE; High performance	US7110H	2.2L L4 135 CID	1987	Base, Shelby; High performance	US7110H
2.5L L4 2507cc 153 CID	1989	Base, C/V, LE, SE	US7122	2.7L V6 2736cc 167 CID	2006	Base	US7161
2.5L L4 2507cc 153 CID	1990	Base, C/V, ES, LE, SE	US7127	2.7L V6 2736cc 167 CID	2007	Base, SE	US7161
2.5L L4 2507cc 153 CID	1991	Base, C/V, LE, SE	US7127	2.7L V6 2736cc 167 CID	2008-2010	SE	US6217
2.5L L4 2507cc 153 CID	1992	Base, C/V, ES, SE	US7127	3.5L V6 3497cc 215 CID	2006-2010	SE, SXT	US8951
2.5L L4 2507cc 153 CID	1993	Base, C/V, SE	US7127	3.6L V6 3604cc 220 CID	2011	SE	US8981
2.5L L4 2507cc 153 CID	1994-1995	Base, C/V	US7127	3.6L V6 3604cc 220 CID	2012	SE, SXT, SXT Plus	US8981
2.6L L4 2555cc 156 CID	1984-1987	Base, LE, SE	US7111	3.6L V6 3604cc 220 CID	2013	SE, SXT	US8981
3.0L V6 2972cc 181 CID	1987-1988	LE, SE	US7121	3.6L V6 3604cc 220 CID	2014-2017	Pursuit, SE, SXT	US8981
3.0L V6 2972cc 181 CID	1987-1988	LE, SE; With back plate housing	US7121-2	3.6L V6 3604cc 220 CID	2018	GT, GT Plus, Pursuit, SXT, SXT Plus, SXT Plus Leather	US8981
3.0L V6 2972cc 181 CID	1989	C/V, LE, SE	US7121	3.7L L6 3687cc 225 CID	1976		US7100
3.0L V6 2972cc 181 CID	1989	C/V, LE, SE; With back plate housing	US7121-2	4.5L V8 4473cc 273 CID	1967		US919
3.0L V6 2972cc 181 CID	1990	Base, C/V, ES, LE, SE	US7121	5.2L V8 318 CID	1967-1969		US919
3.0L V6 2972cc 181 CID	1990	Base, C/V, ES, LE, SE; With back plate housing	US7121-2	5.2L V8 318 CID	1975-1978	Air Pump	US1053
3.0L V6 2972cc 181 CID	1991	C/V, ES, LE, SE	US7121	5.2L V8 318 CID	1975-1978	Exc.Air Pump	US1053
3.0L V6 2972cc 181 CID	1991	C/V, ES, LE, SE; With back plate housing	US7121-2	5.2L V8 318 CID	1975-1978	Air Pump, High performance	US1053H
3.0L V6 2972cc 181 CID	1992-1995	Base, C/V, ES, LE, SE	US7121	5.2L V8 318 CID	1975-1978	Exc.Air Pump, High performance	US1053H
3.0L V6 2972cc 181 CID	1992-1995	Base, C/V, ES, LE, SE; With back plate housing	US7121-2	5.2L V8 5200cc 318 CID	1970-1971	Mexican Application	US1053
3.0L V6 2972cc 181 CID	1996-1997	Base, SE	US7121	5.2L V8 5212cc 318 CID	1966-1969		US919
3.0L V6 2972cc 181 CID	1996-1997	Base, SE; With back plate housing	US7121-2	5.7L V8 345 CID	2006	Daytona R/T, R/T	US8940
3.0L V6 2972cc 181 CID	1998	Base, ES, LE, SE, Sport	US7121	5.7L V8 345 CID	2007	R/T	US8940
3.0L V6 2972cc 181 CID	1998	Base, ES, LE, SE, Sport; With back plate housing	US7121-2	5.7L V8 345 CID	2008	R/T, SE	US8940
3.0L V6 2972cc 181 CID	1998	Base, ES, LE	US7121	5.7L V8 345 CID	2009-2010	R/T, SE	US8979
3.0L V6 2972cc 181 CID	1999	Base, ES, LE	US7121	5.7L V8 345 CID	2011-2012	R/T, SE	US8971
3.0L V6 2972cc 181 CID	1999	Base, ES, LE; With back plate housing	US7121-2	5.7L V8 345 CID	2013	Pursuit, R/T, SE	US8115
3.0L V6 2972cc 181 CID	2000	Base, SE, Sport	US7121	5.7L V8 345 CID	2014	Pursuit, R/T	US8115
3.0L V6 2972cc 181 CID	2000	Base, SE, Sport; With back plate housing	US7121-2	5.7L V8 345 CID	2015-2016	Pursuit, R/T, R/T Road & Track	US8115
				5.7L V8 345 CID	2017-2018	Daytona, Pursuit, R/T	US8115
				5.9L V8 360 CID	1975-1978	Air Pump	US1053

WATER PUMPS

Engine	Years	Application Description	USMWW
<b>DODGE (cont'd.)</b>			
<b>CHARGER (cont'd.)</b>			
5.9L V8 360 CID	1975-1978	Exc.Air Pump	<b>US1053</b>
5.9L V8 360 CID	1975-1978	Air Pump, High performance	<b>US1053H</b>
5.9L V8 360 CID	1975-1978	Exc.Air Pump, High performance	<b>US1053H</b>
5.9L V8 5900cc 360 CID	1972	Mexican Application	<b>US1053</b>
6.1L V8 6059cc 370 CID	2006-2010	SRT8	<b>US8940</b>
6.4L V8 6424cc 392 CID	2012	SRT8	<b>US8971</b>
6.4L V8 6424cc 392 CID	2014	SRT8	<b>US8115</b>
6.4L V8 6424cc 392 CID	2015-2016	R/T Scat Pack, SRT 392	<b>US8115</b>
6.4L V8 6424cc 392 CID	2017-2018	Daytona 392, R/T 392, SRT 392	<b>US8115</b>
6.6L V8 400 CID	1975-1978		<b>US1040</b>
<b>CHARGER SXT</b>			
3.6L V6 3604cc 220 CID	2011	Mexican Application	<b>US8981</b>
<b>COLT</b>			
1.4L L4 1410cc	1979		<b>US7106</b>
1.4L L4 1410cc	1980	Base	<b>US7106</b>
1.4L L4 1410cc	1981	Base	<b>US7115</b>
1.4L L4 1410cc	1982-1983	Base, Deluxe	<b>US7115</b>
1.4L L4 1410cc	1984	DL, E	<b>US7115</b>
1.5L L4 1468cc 90 CID	1985-1987	DL, E, Premier	<b>US7115</b>
1.5L L4 1468cc 90 CID	1988	Base, DL, E, Premier	<b>US7115</b>
1.5L L4 1468cc 90 CID	1989	Base, DL, E, GT	<b>US7115</b>
1.5L L4 1468cc 90 CID	1990	Base, DL, GL, GT	<b>US7115</b>
1.5L L4 1468cc 90 CID	1991-1993	Base, GL	<b>US7115</b>
1.5L L4 1468cc 90 CID	1994	Base, ES	<b>US7115</b>
1.6L L4 1597cc 98 CID	1975-1977		<b>US1012</b>
1.6L L4 1597cc 98 CID	1978		<b>US7105</b>
1.6L L4 1597cc 98 CID	1979		<b>US7104</b>
1.6L L4 1597cc 98 CID	1980	Base, Custom	<b>US7104</b>
1.6L L4 1597cc 98 CID	1981	Custom	<b>US7108</b>
1.6L L4 1597cc 98 CID	1982	Custom, Deluxe	<b>US7108</b>
1.6L L4 1597cc 98 CID	1983	Base, Custom, Deluxe	<b>US7108</b>
1.6L L4 1597cc 98 CID	1984	DL, E	<b>US7108</b>
1.6L L4 1597cc 98 CID	1985-1986	DL, Premier	<b>US7108</b>
1.6L L4 1597cc 98 CID	1987-1988	Premier	<b>US7108</b>
1.6L L4 1597cc 98 CID	1989-1990	GT	<b>US7131</b>
1.8L L4 1754cc 107 CID	1989-1990	DL	<b>US7108</b>
1.8L L4 1834cc 112 CID	1993	Base, GL	<b>US7135</b>
1.8L L4 1834cc 112 CID	1994	Base, ES	<b>US7135</b>
2.0L L4 1995cc 122 CID	1975		<b>US1124</b>
2.0L L4 1995cc 122 CID	1976-1977		<b>US7120</b>
2.0L L4 1995cc 122 CID	1984	Vista	<b>US7118</b>
2.0L L4 1997cc 122 CID	1985	Vista	<b>US7118</b>
2.0L L4 1997cc 122 CID	1986	Vista, Vista Custom	<b>US7118</b>
2.0L L4 1997cc 122 CID	1987-1991	Vista	<b>US7118</b>
2.6L L4 2555cc 156 CID	1978-1979		<b>US7120</b>
2.6L L4 2555cc 156 CID	1980	Base	<b>US7120</b>
<b>CONQUEST</b>			
2.6L L4 2555cc 156 CID	1984	Base	<b>US7115</b>
2.6L L4 2555cc 156 CID	1985-1986	Base	<b>US7120</b>
<b>CORONET</b>			
3.7L L6 3687cc 225 CID	1975-1976		<b>US7100</b>
3.7L L6 3700cc 225 CID	1965-1970	Mexican Application	<b>US7100</b>
4.5L V8 273 CID	1965-1968		<b>US919</b>
4.5L V8 4473cc 273 CID	1965-1968		<b>US919</b>
5.2L V8 318 CID	1965-1969		<b>US919</b>
5.2L V8 318 CID	1975-1976	Air Pump	<b>US1053</b>
5.2L V8 318 CID	1975-1976	Exc.Air Pump	<b>US1053</b>
5.2L V8 318 CID	1975-1976	Air Pump, High performance	<b>US1053H</b>
5.2L V8 318 CID	1975-1976	Exc.Air Pump, High performance	<b>US1053H</b>
5.2L V8 5200cc 318 CID	1970-1971	Mexican Application	<b>US1053</b>
5.2L V8 5212cc 318 CID	1965-1969		<b>US919</b>
5.9L V8 360 CID	1975-1976	Air Pump	<b>US1053</b>
5.9L V8 360 CID	1975-1976	Exc.Air Pump	<b>US1053</b>
5.9L V8 360 CID	1975-1976	Air Pump, High performance	<b>US1053H</b>
5.9L V8 360 CID	1975-1976	Exc.Air Pump, High performance	<b>US1053H</b>
6.6L V8 400 CID	1975-1976		<b>US1040</b>
7.2L V8 440 CID	1975-1976		<b>US1040</b>
<b>D50</b>			
2.0L L4 1995cc 122 CID	1979		<b>US7120</b>
2.0L L4 1995cc 122 CID	1980	Base	<b>US7120</b>
2.0L L4 1997cc 122 CID	1981-1982	Custom	<b>US7120</b>
2.6L L4 2555cc 156 CID	1979		<b>US7120</b>
2.6L L4 2555cc 156 CID	1980	Sport	<b>US7120</b>
2.6L L4 2555cc 156 CID	1981	Royal, Sport	<b>US7120</b>
2.6L L4 2555cc 156 CID	1982	Custom, Royal, Sport	<b>US7120</b>
<b>D100</b>			
3.7L L6 3687cc 225 CID	1975-1979		<b>US7100</b>
3.7L L6 3687cc 225 CID	1985-1987	Custom	<b>US7100</b>
3.7L L6 3700cc 225 CID	1970-1974	Mexican Application	<b>US7100</b>
3.9L V6 3906cc 239 CID	1988-1989	Custom	<b>US1053</b>
3.9L V6 3906cc 239 CID	1988-1989	Custom; High performance	<b>US1053H</b>
5.2L V8 5211cc 318 CID	1975-1978	Exc.Air Pump	<b>US1053</b>
5.2L V8 5211cc 318 CID	1975-1978	Exc.Air Pump, High performance	<b>US1053H</b>

Engine	Years	Application Description	USMWW
<b>DODGE (cont'd.)</b>			
<b>D100 (cont'd.)</b>			
5.2L V8 5211cc 318 CID	1975-1979	Air Pump	<b>US1053</b>
5.2L V8 5211cc 318 CID	1975-1979	Air Pump, High performance	<b>US1053H</b>
5.2L V8 5211cc 318 CID	1985-1989	Custom	<b>US1053</b>
5.2L V8 5211cc 318 CID	1985-1989	Custom; High performance	<b>US1053H</b>
5.9L V8 360 CID	1975-1978	Exc.Air Pump	<b>US1053</b>
5.9L V8 360 CID	1975-1978	Exc.Air Pump, High performance	<b>US1053H</b>
5.9L V8 360 CID	1975-1979	Air Pump	<b>US1053</b>
5.9L V8 360 CID	1975-1979	Air Pump, High performance	<b>US1053H</b>
5.9L V8 360 CID	1985-1988	Custom	<b>US1053</b>
5.9L V8 360 CID	1985-1988	Custom; High performance	<b>US1053H</b>
6.6L V8 400 CID	1976-1978		<b>US1040</b>
7.2L V8 440 CID	1975-1978		<b>US1040</b>
<b>D100 PICKUP</b>			
3.8L L6 3770cc 230 CID	1958-1959		<b>US713</b>
5.2L V8 318 CID	1968-1969		<b>US919</b>
5.2L V8 5212cc 318 CID	1968-1969		<b>US919</b>
<b>D100 SERIES</b>			
5.2L V8 5212cc 318 CID	1960-1967		<b>US919</b>
<b>D150</b>			
3.7L L6 3687cc 225 CID	1977-1979		<b>US7100</b>
3.7L L6 3687cc 225 CID	1980-1981	Base	<b>US7100</b>
3.7L L6 3687cc 225 CID	1982-1983	Base, Miser	<b>US7100</b>
3.7L L6 3687cc 225 CID	1984-1987	Base	<b>US7100</b>
3.7L L6 3700cc 225 CID	1980	Mexican Application	<b>US7100</b>
3.7L L6 3700cc 225 CID	1988-1990	Mexican Application	<b>US7100</b>
3.9L V6 3906cc 239 CID	1988-1989	Base	<b>US1053</b>
3.9L V6 3906cc 239 CID	1988-1989	Base; High performance	<b>US1053H</b>
3.9L V6 3906cc 239 CID	1990-1991	Base, S	<b>US1053</b>
3.9L V6 3906cc 239 CID	1990-1991	Base, S; High performance	<b>US1053H</b>
3.9L V6 3906cc 239 CID	1992	Base	<b>US7159</b>
3.9L V6 3906cc 239 CID	1993	Base	<b>US7160</b>
5.2L V8 5211cc 318 CID	1977-1978	Exc.Air Pump	<b>US1053</b>
5.2L V8 5211cc 318 CID	1977-1978	Exc.Air Pump, High performance	<b>US1053H</b>
5.2L V8 5211cc 318 CID	1977-1979	Air Pump	<b>US1053</b>
5.2L V8 5211cc 318 CID	1977-1979	Air Pump, High performance	<b>US1053H</b>
5.2L V8 5211cc 318 CID	1980-1981	Base	<b>US1053</b>
5.2L V8 5211cc 318 CID	1980-1981	Base; High performance	<b>US1053H</b>
5.2L V8 5211cc 318 CID	1982-1983	Base, Miser	<b>US1053</b>
5.2L V8 5211cc 318 CID	1982-1983	Base, Miser; High performance	<b>US1053H</b>
5.2L V8 5211cc 318 CID	1984-1989	Base	<b>US1053</b>
5.2L V8 5211cc 318 CID	1984-1989	Base; High performance	<b>US1053H</b>
5.2L V8 5211cc 318 CID	1990-1991	Base, S	<b>US1053</b>
5.2L V8 5211cc 318 CID	1990-1991	Base, S; High performance	<b>US1053H</b>
5.2L V8 5211cc 318 CID	1992	Base	<b>US7159</b>
5.2L V8 5211cc 318 CID	1993	Base	<b>US7160</b>
5.9L V8 360 CID	1977-1978	Exc.Air Pump	<b>US1053</b>
5.9L V8 360 CID	1977-1978	Exc.Air Pump, High performance	<b>US1053H</b>
5.9L V8 360 CID	1977-1979	Air Pump	<b>US1053</b>
5.9L V8 360 CID	1977-1979	Air Pump, High performance	<b>US1053H</b>
5.9L V8 360 CID	1980-1981	Base	<b>US1053</b>
5.9L V8 360 CID	1980-1981	Base; High performance	<b>US1053H</b>
5.9L V8 360 CID	1982	Base, Miser	<b>US1053</b>
5.9L V8 360 CID	1982	Base, Miser; High performance	<b>US1053H</b>
5.9L V8 360 CID	1983		<b>US1053</b>
5.9L V8 360 CID	1983	High performance	<b>US1053H</b>
5.9L V8 360 CID	1984-1991	Base	<b>US1053</b>
5.9L V8 360 CID	1984-1991	Base; High performance	<b>US1053H</b>
5.9L V8 360 CID	1993	Base	<b>US7160</b>
5.9L V8 5900cc 360 CID	1980	Mexican Application	<b>US1053</b>
5.9L V8 5900cc 360 CID	1982-1983	Mexican Application	<b>US1053</b>
5.9L V8 5900cc 360 CID	1989-1990	Mexican Application	<b>US1053</b>
6.6L V8 400 CID	1977-1978		<b>US1040</b>
7.2L V8 440 CID	1978		<b>US1040</b>
<b>D200</b>			
3.7L L6 3687cc 225 CID	1975-1979		<b>US7100</b>
3.7L L6 3687cc 225 CID	1980	Base	<b>US7100</b>
5.2L V8 5211cc 318 CID	1975-1978	Exc.Air Pump	<b>US1053</b>
5.2L V8 5211cc 318 CID	1975-1978	Exc.Air Pump, High performance	<b>US1053H</b>
5.2L V8 5211cc 318 CID	1975-1979	Air Pump	<b>US1053</b>
5.2L V8 5211cc 318 CID	1975-1979	Air Pump, High performance	<b>US1053H</b>
5.2L V8 5211cc 318 CID	1980	Base	<b>US1053</b>
5.2L V8 5211cc 318 CID	1980	Base; High performance	<b>US1053H</b>
5.9L V8 360 CID	1975-1978	Exc.Air Pump	<b>US1053</b>
5.9L V8 360 CID	1975-1978	Exc.Air Pump, High performance	<b>US1053H</b>
5.9L V8 360 CID	1975-1979	Air Pump	<b>US1053</b>
5.9L V8 360 CID	1975-1979	Air Pump, High performance	<b>US1053H</b>
5.9L V8 360 CID	1980	Base	<b>US1053</b>
5.9L V8 360 CID	1980	Base; High performance	<b>US1053H</b>
6.6L V8 400 CID	1975-1978		<b>US1040</b>
7.2L V8 440 CID	1975-1978		<b>US1040</b>
<b>D200 PICKUP</b>			
3.8L L6 3770cc 230 CID	1958-1959		<b>US713</b>
5.2L V8 318 CID	1968-1969		<b>US919</b>



Engine	Years	Application Description	USMW	Engine	Years	Application Description	USMW
<b>DODGE (cont'd.)</b>				<b>DODGE (cont'd.)</b>			
<b>D200 PICKUP (cont'd.)</b>				<b>DAKOTA (cont'd.)</b>			
5.2L V8 5212cc 318 CID	1968-1969		US919	3.9L V6 3906cc 239 CID	1987	Base, LE, SE; High performance	US1053H
<b>D200 SERIES</b>				3.9L V6 3906cc 239 CID	1988-1989	Base, LE, SE, Sport	US1053
5.2L V8 5212cc 318 CID	1960-1967		US919	3.9L V6 3906cc 239 CID	1988-1989	Base, LE, SE, Sport; High performance	US1053H
<b>D250</b>				3.9L V6 3906cc 239 CID	1990-1991	Base, LE, S, SE, Sport	US1053
3.7L L6 3687cc 225 CID	1981-1987		US7100	3.9L V6 3906cc 239 CID	1990-1991	Base, LE, S, SE, Sport; High performance	US1053H
3.9L V6 3906cc 239 CID	1988-1991	Base	US1053	3.9L V6 3906cc 239 CID	1992	Base, LE, S, Sport	US7159
3.9L V6 3906cc 239 CID	1988-1991	Base; High performance	US1053H	3.9L V6 3906cc 239 CID	1993	Base, LE, Sport	US7160
3.9L V6 3906cc 239 CID	1992	Base	US7159	3.9L V6 3906cc 239 CID	1994-1996	Base, SLT, Sport, WS	US7160
3.9L V6 3906cc 239 CID	1993	Base	US7160	3.9L V6 3906cc 239 CID	1997-2001	Base, SLT, Sport	US7160
5.2L V8 5211cc 318 CID	1981-1991	Base	US1053	3.9L V6 3906cc 239 CID	2002	Base, SLT, Sport, SXT	US7160
5.2L V8 5211cc 318 CID	1981-1991	Base; High performance	US1053H	3.9L V6 3906cc 239 CID	2003	Base, SLT, Sport	US7160
5.2L V8 5211cc 318 CID	1992	Base	US7159	4.7L V8 287 CID	2000-2001	Base, SLT, Sport	US7163
5.2L V8 5211cc 318 CID	1993	Base	US7160	4.7L V8 287 CID	2002	Base, SLT, Sport, SXT	US7163
5.9L L6 359 CID	1989-1993	Base	US7145	4.7L V8 287 CID	2003	Base, SLT, Sport	US7163
5.9L L6 359 CID	1989-1993		US7145N	4.7L V8 287 CID	2004	SLT, SLT Plus, Sport, Sport Plus	US7163
5.9L V8 360 CID	1981-1982	Base	US1053	4.7L V8 287 CID	2005	Laramie, SLT, Sport, ST	US7163
5.9L V8 360 CID	1981-1982	Base; High performance	US1053H	4.7L V8 287 CID	2006-2007	Laramie, SLT, ST	US7163
5.9L V8 360 CID	1984-1992	Base	US1053	4.7L V8 287 CID	2008	Laramie, SLT, Sport, SXT, TRX, TRX4	US7163
5.9L V8 360 CID	1984-1992	Base; High performance	US1053H	4.7L V8 287 CID	2009-2010	Big Horn, Laramie, Lone Star, TRX4	US7163
5.9L V8 360 CID	1993	Base; (5)	US7160	5.2L V8 5211cc 318 CID	1989	Shelby	US1053
5.9L V8 360 CID	1993	Base; (Z)	US7160	5.2L V8 5211cc 318 CID	1989	Shelby; High performance	US1053H
5.9L V8 5900cc 360 CID	1989-1990	Mexican Application	US1053	5.2L V8 5211cc 318 CID	1990	Base, LE, SE	US7128
<b>D300</b>				5.2L V8 5211cc 318 CID	1991	Base, LE, S, SE, Sport	US7128
3.7L L6 3687cc 225 CID	1975-1978		US7100	5.2L V8 5211cc 318 CID	1992	Base, LE, S, Sport	US7159
3.7L L6 3700cc 225 CID	1967-1968	Mexican Application	US7100	5.2L V8 5211cc 318 CID	1993	Base, LE, Sport	US7160
3.7L L6 3700cc 225 CID	1978-1979	Mexican Application	US7100	5.2L V8 5211cc 318 CID	1994-1996	Base, SLT, Sport, WS	US7160
5.2L V8 5211cc 318 CID	1975-1978	Exc. Air Pump	US1053	5.2L V8 5211cc 318 CID	1997-1999	Base, SLT, Sport	US7160
5.2L V8 5211cc 318 CID	1975-1978	Exc. Air Pump, High performance	US1053H	5.9L V8 360 CID	1998-1999	R/T	US7160
5.2L V8 5211cc 318 CID	1975-1979	Air Pump	US1053	5.9L V8 360 CID	2000-2003	R/T, SLT, Sport	US7160
5.2L V8 5211cc 318 CID	1975-1979	Air Pump, High performance	US1053H	<b>DART</b>			
5.2L V8 5211cc 318 CID	1980	Base	US1053	1.4L L4 1368cc 83 CID	2013	Aero, Limited, Rallye, SXT	US8136
5.2L V8 5211cc 318 CID	1980	Base; High performance	US1053H	1.4L L4 1368cc 83 CID	2014-2016	Aero	US8136
5.9L V8 360 CID	1975-1978	Exc. Air Pump	US1053	2.0L L4 1995cc 122 CID	2013	Limited, Rallye, SE, SXT	US6038
5.9L V8 360 CID	1975-1978	Exc. Air Pump, High performance	US1053H	2.0L L4 1995cc 122 CID	2014-2016	SE, SXT	US6038
5.9L V8 360 CID	1975-1979	Air Pump	US1053	2.2L L4 2200cc 135 CID	1982-1988	Mexican Application	US7110
5.9L V8 360 CID	1975-1979	Air Pump, High performance	US1053H	2.2L L4 2200cc 135 CID	1989	Mexican Application	US7122
5.9L V8 360 CID	1980	Base	US1053	2.4L L4 2360cc 144 CID	2013	GT, R/T	US6038
5.9L V8 360 CID	1980	Base; High performance	US1053H	2.4L L4 2360cc 144 CID	2014-2016	GT, Limited, SXT	US6038
6.6L V8 400 CID	1976-1978		US1040	3.7L L6 3687cc 225 CID	1975-1976		US7100
7.2L V8 440 CID	1975-1978		US1040	3.7L L6 3687cc 225 CID	1977	Base	US7100
<b>D300 PICKUP</b>				3.7L L6 3700cc 225 CID	1965-1974	Mexican Application	US7100
3.8L L6 3770cc 230 CID	1958-1959		US713	3.7L L6 3700cc 225 CID	1977-1982	Mexican Application	US7100
5.2L V8 318 CID	1968-1969		US919	4.5L V8 273 CID	1964-1969		US919
5.2L V8 5212cc 318 CID	1968-1969		US919	4.5L V8 4473cc 273 CID	1964-1969		US919
<b>D300 SERIES</b>				5.2L V8 318 CID	1960-1962		US919
5.2L V8 5212cc 318 CID	1960-1967		US919	5.2L V8 318 CID	1968-1969		US919
<b>D350</b>				5.2L V8 318 CID	1975-1976	Air Pump	US1053
3.7L L6 3700cc 225 CID	1980-1987	Mexican Application	US7100	5.2L V8 318 CID	1975-1976	Exc. Air Pump	US1053
3.7L L6 3700cc 225 CID	1989-1990	Mexican Application	US7100	5.2L V8 318 CID	1975-1976	Air Pump, High performance	US1053H
5.2L V8 5200cc 318 CID	1980	Mexican Application	US1053	5.2L V8 318 CID	1975-1976	Exc. Air Pump, High performance	US1053H
5.2L V8 5200cc 318 CID	1982	Mexican Application	US1053	5.2L V8 318 CID	1975-1976		US919
5.2L V8 5211cc 318 CID	1981-1983	Base	US1053	5.2L V8 5212cc 318 CID	1960-1962		US919
5.2L V8 5211cc 318 CID	1981-1983	Base; High performance	US1053H	5.6L V8 340 CID	1968-1969		US919
5.9L L6 359 CID	1989-1993	Base	US7145	5.6L V8 340 CID	1968-1969		US919
5.9L L6 359 CID	1989-1993		US7145N	5.6L V8 5572cc 340 CID	1968-1969		US919
5.9L V8 360 CID	1981-1992	Base	US1053	5.9L V8 360 CID	1975-1976	Air Pump	US1053
5.9L V8 360 CID	1981-1992	Base; High performance	US1053H	5.9L V8 360 CID	1975-1976	Exc. Air Pump	US1053
5.9L V8 360 CID	1993	Base	US7160	5.9L V8 360 CID	1975-1976	Air Pump, High performance	US1053H
5.9L V8 5900cc 360 CID	1980-1983	Mexican Application	US1053	5.9L V8 360 CID	1975-1976	Exc. Air Pump, High performance	US1053H
5.9L V8 5900cc 360 CID	1989-1990	Mexican Application	US1053	5.9L V8 360 CID	1982		US1053
<b>DAKOTA</b>				5.9L V8 360 CID	1982	High performance	US1053H
2.2L L4 135 CID	1987	Base, LE, SE	US7110	5.9L V8 5900cc 360 CID	1977-1978	Mexican Application	US1053
2.2L L4 135 CID	1987	Base, LE, SE; High performance	US7110H	5.9L V8 5900cc 360 CID	1980-1982	Mexican Application	US1053
2.2L L4 135 CID	1988	Base, LE, SE, Sport	US7110	<b>DAYTONA</b>			
2.2L L4 135 CID	1988	Base, LE, SE, Sport; High performance	US7110H	2.2L L4 135 CID	1984-1986	Base	US7110
2.5L L4 2507cc 153 CID	1989	Base, LE, SE, Sport	US7122	2.2L L4 135 CID	1984-1986	Base; High performance	US7110H
2.5L L4 2507cc 153 CID	1990-1991	Base, LE, S, SE	US7127	2.2L L4 135 CID	1987-1988	Base, Shelby Z	US7110
2.5L L4 2507cc 153 CID	1992-1993	Base, LE, S, Sport	US7127	2.2L L4 135 CID	1987-1988	Base, Shelby Z; High performance	US7110H
2.5L L4 2507cc 153 CID	1994-1995	Base, SLT, Sport, WS	US7127	2.2L L4 135 CID	1989	Base, Shelby	US7122
2.5L L4 2507cc 153 CID	1996	Base, SLT, Sport, WS	US7136	2.2L L4 135 CID	1990	Base, Shelby	US7127
2.5L L4 2507cc 153 CID	1997-2001	Base, SLT, Sport	US7136	2.2L L4 135 CID	1992-1993	Iroc R/T	US7139
2.5L L4 2507cc 153 CID	2002	Base, Sport	US7136	2.2L L4 135 CID	1986-1988	Base	US7110
3.7L V6 226 CID	2004	Base, SLT, SLT Plus, Sport, Sport Plus, SXT	US7163	2.5L L4 2507cc 153 CID	1986-1988	Base; High performance	US7110H
3.7L V6 226 CID	2005	Laramie, SLT, Sport, ST	US7163	2.5L L4 2507cc 153 CID	1989	Base, ES, ES Turbo, Shelby	US7122
3.7L V6 226 CID	2006-2007	Laramie, SLT, ST	US7163	2.5L L4 2507cc 153 CID	1990	Base, ES, ES Turbo, Shelby	US7127
3.7L V6 226 CID	2008	SLT, Sport, ST, SXT, TRX, TRX4	US7163	2.5L L4 2507cc 153 CID	1991	Base, ES, Iroc, Shelby	US7127
3.7L V6 226 CID	2009	Big Horn, Lone Star, ST, TRX4	US7163	2.5L L4 2507cc 153 CID	1992	Base, ES, Iroc	US7127
3.7L V6 226 CID	2010	Big Horn, Laramie, Lone Star, ST	US7163	2.5L L4 2507cc 153 CID	1993	Base, ES	US7127
3.7L V6 3701cc 226 CID	2010	Mexican Application	US7163	3.0L V6 2972cc 181 CID	1990	Base, ES	US7121
3.7L V6 3701cc 226 CID	2012	Mexican Application	US7163	3.0L V6 2972cc 181 CID	1990	Base, ES; With back plate housing	US7121-2
3.9L V6 3906cc 239 CID	1987	Base, LE, SE	US1053	3.0L V6 2972cc 181 CID	1991-1993	Base, ES, Iroc	US7121
				3.0L V6 2972cc 181 CID	1991-1993	Base, ES, Iroc; With back plate housing	US7121-2
				<b>DIPLOMAT</b>			
				3.7L L6 3687cc 225 CID	1978-1979		US7100

WATER PUMPS



Engine	Years	Application Description	USMW
<b>DODGE (cont'd.)</b>			
<b>DIPLOMAT (cont'd.)</b>			
3.7L L6 3687cc 225 CID	1980	Base, Medallion, Salon	US7100
3.7L L6 3687cc 225 CID	1981	Base, Medallion, Salon, Sport	US7100
3.7L L6 3687cc 225 CID	1982-1983	Medallion, Salon	US7100
5.2L V8 318 CID	1977-1978	Exc.Air Pump	US1053
5.2L V8 318 CID	1977-1978	Exc.Air Pump, High performance	US1053H
5.2L V8 318 CID	1977-1979	Air Pump	US1053
5.2L V8 318 CID	1977-1979	Air Pump, High performance	US1053H
5.2L V8 318 CID	1980-1981	Base, Medallion, Salon	US1053
5.2L V8 318 CID	1980-1981	Base, Medallion, Salon; High performance	US1053H
5.2L V8 318 CID	1982-1983	Medallion, Salon	US1053
5.2L V8 318 CID	1982-1983	Medallion, Salon; High performance	US1053H
5.2L V8 318 CID	1984-1989	Salon, SE	US1053
5.2L V8 318 CID	1984-1989	Salon, SE; High performance	US1053H
5.2L V8 5211cc 318 CID	1983	Medallion	US1053
5.2L V8 5211cc 318 CID	1983	Medallion; High performance	US1053H
5.2L V8 5211cc 318 CID	1985	Salon, SE	US1053
5.2L V8 5211cc 318 CID	1985	Salon, SE; High performance	US1053H
5.9L V8 360 CID	1978	Exc.Air Pump	US1053
5.9L V8 360 CID	1978	Exc.Air Pump, High performance	US1053H
5.9L V8 360 CID	1978-1979	Air Pump	US1053
5.9L V8 360 CID	1978-1979	Air Pump, High performance	US1053H
<b>DM350</b>			
5.9L V8 5904cc 360 CID	1991	Mexican Application	US1053
<b>DURANGO</b>			
3.6L V6 3604cc 220 CID	2011	Citadel, Crew, Express, Heat	US8981
3.6L V6 3604cc 220 CID	2012-2013	Citadel, Crew, Special Service, SXT	US8981
3.6L V6 3604cc 220 CID	2012-2015	Mexican Application	US8981
3.6L V6 3604cc 220 CID	2014-2015	Citadel, Limited, Rallye, Special Service, SXT	US8981
3.6L V6 3604cc 220 CID	2016	Citadel, Limited, Special Service, SXT	US8160
3.6L V6 3604cc 220 CID	2017-2018	Citadel, GT, Special Service, SXT	US8160
3.7L V6 226 CID	2004-2005	SLT, ST	US7163
3.7L V6 226 CID	2006-2008	SLT, SXT	US7163
3.7L V6 226 CID	2009	SE, SLT	US7163
3.9L V6 3906cc 239 CID	1998	Base, SLT	US7160
3.9L V6 3906cc 239 CID	1999	Base, SLT, SLT Plus	US7160
4.7L V8 287 CID	2000	Base, SLT, SLT Plus, Sport	US7163
4.7L V8 287 CID	2001	Base, SLT	US7163
4.7L V8 287 CID	2002	SLT, SLT Plus, Sport	US7163
4.7L V8 287 CID	2003	SLT, SLT Plus, Sport, SXT	US7163
4.7L V8 287 CID	2004	Limited, SLT, ST	US7163
4.7L V8 287 CID	2005	Limited, SLT, ST, SXT	US7163
4.7L V8 287 CID	2006-2008	Adventurer, Limited, SLT, SXT	US7163
4.7L V8 287 CID	2009	Limited, SE, SLT	US7163
5.2L V8 5211cc 318 CID	1998	Base, SLT	US7160
5.2L V8 5211cc 318 CID	1999	Base, SLT, SLT Plus	US7160
5.2L V8 5211cc 318 CID	2000	Base, SLT, SLT Plus, Sport	US7160
5.2L V8 5215cc 318 CID	1998	Mexican Application	US7160
5.7L V8 345 CID	2004	Limited, SLT	US7168
5.7L V8 345 CID	2005	Limited, SLT, ST	US7168
5.7L V8 345 CID	2006	Adventurer, Limited, SLT	US7168
5.7L V8 345 CID	2007	Adventurer, Limited, SLT, SXT	US7168
5.7L V8 345 CID	2008	Adventurer, Limited, SLT	US7168
5.7L V8 345 CID	2009	Limited, SE, SLT	US6341
5.7L V8 345 CID	2011	Citadel, Crew, R/T	US8971
5.7L V8 345 CID	2012	Citadel, Crew, R/T, Special Service	US8971
5.7L V8 345 CID	2013	Citadel, Crew, R/T, Special Service; Exc.Oil Cooler	US8115
5.7L V8 345 CID	2013	Citadel, Crew, R/T, Special Service; Oil Cooler	US8115
5.7L V8 345 CID	2014-2016	Citadel, Limited, R/T, Special Service	US8115
5.7L V8 345 CID	2014-2016	Citadel, Limited, R/T, Special Service; Exc.Oil Cooler	US8115
5.7L V8 345 CID	2014-2016	Citadel, Limited, R/T, Special Service; Oil Cooler	US8115
5.7L V8 345 CID	2017	Citadel, R/T, Special Service	US8115
5.7L V8 345 CID	2018	Citadel, Pursuit, R/T, Special Service	US8115
5.7L V8 5654cc 345 CID	2012-2013	Mexican Application	US8971
5.9L V8 360 CID	1998	Base, SLT	US7160
5.9L V8 360 CID	1999	Base, SLT, SLT Plus	US7160
5.9L V8 360 CID	2000	Base, R/T, SLT, SLT Plus, Sport	US7160
5.9L V8 360 CID	2001	Base, R/T, SLT	US7160
5.9L V8 360 CID	2002	R/T, SLT, SLT Plus, Sport	US7160
5.9L V8 360 CID	2003	R/T, SLT, SLT Plus, Sport, SXT	US7160
6.4L V8 6424cc 392 CID	2018	SRT	US8115
<b>DYNASTY</b>			
2.5L L4 2507cc 153 CID	1988	Base, LE	US7110
2.5L L4 2507cc 153 CID	1988	Base, LE; High performance	US7110H
2.5L L4 2507cc 153 CID	1989	Base	US7122
2.5L L4 2507cc 153 CID	1990-1993	Base	US7127
3.0L V6 2972cc 181 CID	1988-1990	Base, LE	US7121
3.0L V6 2972cc 181 CID	1988-1990	Base, LE; With back plate housing	US7121-2
3.0L V6 2972cc 181 CID	1991-1993	Base, LS	US7121
3.0L V6 2972cc 181 CID	1991-1993	Base, LS; With back plate housing	US7121-2
3.3L V6 3301cc 201 CID	1990	LE	US7126

Engine	Years	Application Description	USMW
<b>DODGE (cont'd.)</b>			
<b>DYNASTY (cont'd.)</b>			
3.3L V6 3301cc 201 CID	1991-1993	Base, LS	US7126
<b>GRAND CARAVAN</b>			
2.4L L4 2429cc 148 CID	1996	Base, SE; Hydraulic Tensioner	US7153
2.4L L4 2429cc 148 CID	1996	Base, SE; Mechanical Tensioner	US7156
2.4L L4 2429cc 148 CID	1997	Base, SE	US7156
2.5L L4 2507cc 153 CID	1988	SE	US7110
2.5L L4 2507cc 153 CID	1988	SE; High performance	US7110H
3.0L V6 2972cc 181 CID	1988-1989	LE, SE	US7121
3.0L V6 2972cc 181 CID	1988-1989	LE, SE; With back plate housing	US7121-2
3.0L V6 2972cc 181 CID	1992	Base, ES, SE	US7121
3.0L V6 2972cc 181 CID	1992	Base, ES, SE; With back plate housing	US7121-2
3.0L V6 2972cc 181 CID	1993	Base	US7121
3.0L V6 2972cc 181 CID	1993	Base; With back plate housing	US7121-2
3.0L V6 2972cc 181 CID	1994-1997	Base, SE	US7121
3.0L V6 2972cc 181 CID	1994-1997	Base, SE; With back plate housing	US7121-2
3.0L V6 2972cc 181 CID	1998-1999	Base, ES, LE, SE	US7121
3.0L V6 2972cc 181 CID	1998-1999	Base, ES, LE, SE; With back plate housing	US7121-2
3.0L V6 2972cc 181 CID	2000	Base, SE, Sport	US7121
3.0L V6 2972cc 181 CID	2000	Base, SE, Sport; With back plate housing	US7121-2
3.3L V6 3301cc 201 CID	1990-1991	LE, SE	US7126
3.3L V6 3301cc 201 CID	1992	Base, ES, LE, SE	US7126
3.3L V6 3301cc 201 CID	1993-1996	ES, LE, SE	US7126
3.3L V6 3301cc 201 CID	1997-1999	Base, ES, LE, SE	US7126
3.3L V6 3301cc 201 CID	2000	Base, ES, LE, SE, Sport	US7126
3.3L V6 3301cc 201 CID	2001	ES, SE, Sport	US7165
3.3L V6 3301cc 201 CID	2002	EL, SE, Sport	US7165
3.3L V6 3301cc 201 CID	2003	Base, EL, SE, Sport	US7165
3.3L V6 3301cc 201 CID	2004	C/V, SE	US7165
3.3L V6 3301cc 201 CID	2005	C/V, SE, SE Plus	US7165
3.3L V6 3301cc 201 CID	2006-2007	Base, SE	US7165
3.3L V6 3301cc 201 CID	2008-2010	C/V, SE	US6231
3.6L V6 3604cc 220 CID	2011	C/V, Crew, Express, Mainstreet, R/T	US8981
3.6L V6 3604cc 220 CID	2012-2013	Crew, R/T, SE, SXT	US8981
3.6L V6 3604cc 220 CID	2014	American Value Package, R/T, SE, SE 30th Anniversary Edition, SXT, SXT 30th Anniversary Edition	US8981
3.6L V6 3604cc 220 CID	2015	American Value Package, R/T, SE, SXT	US8981
3.6L V6 3604cc 220 CID	2016	American Value Package, R/T, SE, SE Plus, SXT	US8981
3.6L V6 3604cc 220 CID	2017-2018	GT, SE, SXT	US8981
3.8L V6 230 CID	1994-1996	ES, LE	US7126
3.8L V6 230 CID	1997-1999	ES, LE, SE	US7126
3.8L V6 230 CID	2000	ES, LE, SE, Sport	US7126
3.8L V6 230 CID	2001-2003	ES, EX, Sport	US7165
3.8L V6 230 CID	2004	Anniversary Edition, EX, SXT	US7165
3.8L V6 230 CID	2005-2007	SXT	US7165
3.8L V6 230 CID	2008	SXT	US6231
3.8L V6 3778cc 231 CID	2009-2010	SXT	US6231
4.0L V6 3952cc 241 CID	2008-2010	SXT	US8951
<b>H100</b>			
2.5L L4 2476cc 151 CID	2006-2010		US8922
2.5L L4 2476cc 151 CID	2006-2014	Mexican Application	US8922
2.5L L4 2476cc 151 CID	2011-2013	Base; Standard Cargo Van	US8922
<b>H-100</b>			
2.4L L4 2351cc 144 CID	2003-2005	Mexican Application	US7114
<b>I10</b>			
1.1L L4 1100cc 67 CID	2012-2013	Mexican Application	US8939
<b>INTREPID</b>			
2.7L V6 2736cc 167 CID	1998	Base	US7161
2.7L V6 2736cc 167 CID	1999-2000	Base, ES	US7161
2.7L V6 2736cc 167 CID	2001	ES, SE	US7161
2.7L V6 2736cc 167 CID	2002-2004	SE	US7161
3.2L V6 3200cc 197 CID	1998-2000	ES	US7162
3.3L V6 3301cc 201 CID	1993-1995	Base, ES	US7140
3.3L V6 3301cc 201 CID	1996-1997	Base	US7140
3.5L V6 3497cc 215 CID	1993-1994	Base, ES	US7141
3.5L V6 3497cc 215 CID	1995	Base, ES	US7151
3.5L V6 3497cc 215 CID	1996	ES	US7151
3.5L V6 3497cc 215 CID	1997	Base, ES; 3 Bolt Pattern	US7151
3.5L V6 3497cc 215 CID	1997	Base, ES; 6 Bolt Pattern	US7158
3.5L V6 3497cc 215 CID	2000	R/T	US7162
3.5L V6 3497cc 215 CID	2001	R/T, SE	US7162
3.5L V6 3497cc 215 CID	2002	ES, R/T, SE	US7162
3.5L V6 3497cc 215 CID	2003	ES, SE, SXT	US7162
3.5L V6 3497cc 215 CID	2004	ES, Police, SXT	US7162
<b>JOURNEY</b>			
2.4L L4 2360cc 144 CID	2009	SE	US6038
2.4L L4 2360cc 144 CID	2010	Base, SE	US6038
2.4L L4 2360cc 144 CID	2011	Express	US6038
2.4L L4 2360cc 144 CID	2011	Mexican Application	US6038
2.4L L4 2360cc 144 CID	2012-2013	AVP, SE, SXT	US6038

Engine	Years	Application Description	USMW	Engine	Years	Application Description	USMW
<b>DODGE (cont'd.)</b>				<b>DODGE (cont'd.)</b>			
<b>JOURNEY (cont'd.)</b>				<b>NEON</b>			
2.4L L4 2360cc 144 CID	2014	Crossroad, SE, SXT	US6038	2.0L L4 1996cc 122 CID	1995-1997	Base, High Line, Sport	US7150
2.4L L4 2360cc 144 CID	2014	Mexican Application	US6038	2.0L L4 1996cc 122 CID	1998-1999	ACR, High Line, R/T, Sport	US7150
2.4L L4 2360cc 144 CID	2015	AVP, Crossroad, SE, SXT	US6038	2.0L L4 1996cc 122 CID	2000	ES, High Line	US7150
2.4L L4 2360cc 144 CID	2016-2018	Crossroad, SE, SXT	US6038	2.0L L4 1996cc 122 CID	2001-2002	ACR, Base, ES, R/T, SE	US7150
3.5L V6 3497cc 215 CID	2009	R/T, SXT	US8951	2.0L L4 1996cc 122 CID	2003-2004	R/T, SE, SXT	US7150
3.5L V6 3497cc 215 CID	2010	Crew, R/T, SXT	US8951	2.0L L4 1996cc 122 CID	2005	SE, SXT	US7150
3.6L V6 3604cc 220 CID	2011	Crew, Lux, Mainstreet, R/T	US8981	2.0L L4 1997cc 122 CID	1995	High Line	US7150
3.6L V6 3604cc 220 CID	2011-2013	Mexican Application	US8981	2.4L L4 2429cc 148 CID	2003-2005	SRT-4	US7167
3.6L V6 3604cc 220 CID	2012-2013	Crew, R/T, SXT	US8981	<b>NITRO</b>			
3.6L V6 3604cc 220 CID	2014-2015	Crossroad, Limited, R/T, SXT	US8981	3.7L V6 226 CID	2007-2008	SLT, SXT	US7163
3.6L V6 3604cc 220 CID	2016	Crossroad, R/T, SE, SXT	US8981	3.7L V6 226 CID	2009	SE, SLT	US7163
3.6L V6 3604cc 220 CID	2017-2018	Crossroad, GT, SE, SXT	US8981	3.7L V6 226 CID	2010	SE, SXT	US7163
3.6L V6 3605cc 220 CID	2014-2015	Mexican Application	US8981	3.7L V6 226 CID	2011	Heat, SE, SXT	US7163
<b>LANCER</b>				3.7L V6 3701cc 226 CID	2011-2012	Mexican Application	US7163
2.2L L4 135 CID	1985-1987	Base, ES	US7110	4.0L V6 3952cc 241 CID	2007-2009	R/T	US8951
2.2L L4 135 CID	1985-1987	Base, ES; High performance	US7110H	4.0L V6 3952cc 241 CID	2010-2011	Detonator, Heat, Shock, SXT	US8951
2.2L L4 135 CID	1988	Base, ES, Shelby	US7110	<b>NITRO SE</b>			
2.2L L4 135 CID	1988	Base, ES, Shelby; High performance	US7110H	3.7L V6 3701cc 226 CID	2011-2012	Mexican Application	US7163
2.2L L4 135 CID	1989	Base, Shelby	US7110	<b>OMNI</b>			
2.5L L4 2507cc 153 CID	1986-1988	Base, ES	US7110	1.6L L4 1595cc 97 CID	1983	Base, Custom	US7113
2.5L L4 2507cc 153 CID	1986-1988	Base, ES; High performance	US7110H	1.6L L4 1595cc 97 CID	1984	Base, GLH, SE	US7113
2.5L L4 2507cc 153 CID	1989	Base, ES, Shelby	US7122	1.6L L4 1595cc 97 CID	1985-1986	Base, SE	US7113
<b>MAGNUM</b>				1.7L L4 105 CID	1978-1979		US7101
2.2L L4 2200cc 135 CID	1983-1988	Mexican Application	US7110	1.7L L4 105 CID	1980	024, Base	US7101
2.7L V6 2736cc 167 CID	2005-2007	SE	US7161	1.7L L4 105 CID	1981	024, 024 Miser, Base, Miser	US7101
2.7L V6 2736cc 167 CID	2008	SE	US6217	1.7L L4 105 CID	1982	024, 024 Charger 2.2, 024 Miser, Custom, E-Type, Miser	US7101
3.5L V6 3497cc 215 CID	2005	SXT, SXT Special Edition	US8951	1.7L L4 105 CID	1983	Base, Custom	US7101
3.5L V6 3497cc 215 CID	2006	SXT	US8951	2.2L L4 135 CID	1981	024, 024 Miser, Base, Miser	US7110
3.5L V6 3497cc 215 CID	2007-2008	SE, SXT	US8951	2.2L L4 135 CID	1981	024, 024 Miser, Base, Miser; High performance	US7110H
5.2L V8 318 CID	1978	Exc.Air Pump	US1053	2.2L L4 135 CID	1982	024, 024 Charger 2.2, 024 Miser, Custom, E-Type, Miser	US7110
5.2L V8 318 CID	1978	Exc.Air Pump, High performance	US1053H	2.2L L4 135 CID	1982	024, 024 Charger 2.2, 024 Miser, Custom, E-Type, Miser; High performance	US7110H
5.2L V8 318 CID	1978-1979	Air Pump	US1053	2.2L L4 135 CID	1983	Base, Custom	US7110
5.2L V8 318 CID	1978-1979	Air Pump, High performance	US1053H	2.2L L4 135 CID	1983	Base, Custom; High performance	US7110H
5.7L V8 345 CID	2005-2008	R/T	US8940	2.2L L4 135 CID	1984-1986	Base, GLH, SE	US7110
5.9L V8 360 CID	1978	Exc.Air Pump	US1053	2.2L L4 135 CID	1984-1986	Base, GLH, SE; High performance	US7110H
5.9L V8 360 CID	1978	Exc.Air Pump, High performance	US1053H	2.2L L4 135 CID	1987-1988	America	US7110
5.9L V8 360 CID	1978-1979	Air Pump	US1053	2.2L L4 135 CID	1987-1988	America; High performance	US7110H
5.9L V8 360 CID	1978-1979	Air Pump, High performance	US1053H	2.2L L4 135 CID	1989	America	US7122
5.9L V8 360 CID	1982	High performance	US1053H	2.2L L4 135 CID	1990	Base	US7127
5.9L V8 360 CID	1982	High performance	US1053H	<b>POLARA</b>			
5.9L V8 5900cc 360 CID	1980-1982	Mexican Application	US1053	4.5L V8 4473cc 273 CID	1966		US919
6.1L V8 6059cc 370 CID	2006-2008	SRT8	US8940	5.2L V8 318 CID	1968-1969		US919
6.6L V8 400 CID	1978		US1040	5.2L V8 5212cc 318 CID	1960-1961		US919
<b>MATADOR</b>				5.2L V8 5212cc 318 CID	1963-1969		US919
5.2L V8 5212cc 318 CID	1960		US919	<b>POWER RAM 50</b>			
<b>MICROBUS</b>				2.0L L4 1995cc	1984	Custom	US7114
5.9L V8 5900cc 360 CID	1988-1991	Mexican Application	US1053	2.0L L4 1997cc	1983	Custom	US7114
5.9L V8 5900cc 360 CID	1992	Mexican Application	US7159	2.3L L4 2346cc	1983	Sport	US7117
5.9L V8 5900cc 360 CID	1993-1997	Mexican Application	US7160	2.3L L4 2346cc	1984	Royal, Sport	US7117
<b>MINI RAM</b>				2.3L L4 2346cc	1985	Royal	US7117
2.2L L4 135 CID	1984-1987	Base, Royal	US7110	2.6L L4 2555cc	1983	Sport	US7114
2.2L L4 135 CID	1984-1987	Base, Royal; High performance	US7110H	2.6L L4 2555cc	1984	Custom, Royal, Sport	US7120
2.6L L4 2555cc 156 CID	1984-1987	Base, Royal	US7111	2.6L L4 2555cc 156 CID	1985	Custom, Royal, Sport	US7120
3.0L V6 2972cc 181 CID	1987	Base, Royal	US7121	2.6L L4 2555cc 156 CID	1986	Custom, Sport	US7120
3.0L V6 2972cc 181 CID	1987	Base, Royal; With back plate housing	US7121-2	<b>PROMASTER 1500</b>			
3.0L V6 2972cc 181 CID	1988	Base	US7121	3.6L V6 3605cc 220 CID	2014	Mexican Application	US8981
3.0L V6 2972cc 181 CID	1988	Base; With back plate housing	US7121-2	<b>PROMASTER 2500</b>			
<b>MIRADA</b>				3.6L V6 3605cc 220 CID	2014	Mexican Application	US8981
3.7L L6 3687cc 225 CID	1980-1983	Special Coupe	US7100	<b>PROMASTER 3500</b>			
5.2L V8 318 CID	1980-1983	Special Coupe	US1053	3.6L V6 3605cc 220 CID	2014	Mexican Application	US8981
5.2L V8 318 CID	1980-1983	Special Coupe; High performance	US1053H	<b>RAIDER</b>			
5.9L V8 360 CID	1980	Special Coupe	US1053	2.6L L4 2555cc 156 CID	1987-1989	Base	US7120
5.9L V8 360 CID	1980	Special Coupe; High performance	US1053H	3.0L V6 2972cc 181 CID	1989	Base	US7121
<b>MONACO</b>				3.0L V6 2972cc 181 CID	1989	Base; With back plate housing	US7121-2
3.0L V6 2972cc 182 CID	1990	ES, LE	US3411	<b>RAM 50</b>			
3.0L V6 2972cc 182 CID	1991	ES, LE; (Z7X-711)	US3411	2.0L L4 1995cc 122 CID	1984	Custom, Royal	US7114
3.7L L6 3687cc 225 CID	1977-1978		US7100	2.0L L4 1995cc 122 CID	1985-1986	Custom	US7114
5.2L V8 318 CID	1968-1969		US919	2.0L L4 1995cc 122 CID	1987	Base, Custom	US7114
5.2L V8 318 CID	1975-1978	Air Pump	US1053	2.0L L4 1995cc 122 CID	1988-1989	Base	US7114
5.2L V8 318 CID	1975-1978	Exc.Air Pump	US1053	2.0L L4 1997cc 122 CID	1983	Custom	US7114
5.2L V8 318 CID	1975-1978	Air Pump, High performance	US1053H	2.3L L4 2346cc 143 CID	1983-1984	Royal, Sport	US7117
5.2L V8 318 CID	1975-1978	Exc.Air Pump, High performance	US1053H	2.3L L4 2346cc 143 CID	1985	Royal	US7117
5.2L V8 5200cc 318 CID	1970-1974	Mexican Application	US1053	2.4L L4 2351cc	1990-1991	Base, LE, SE	US7114
5.2L V8 5212cc 318 CID	1968-1969		US919	2.4L L4 2351cc	1992-1993	Base, SE	US7114
5.9L V8 360 CID	1975-1978	Air Pump	US1053	2.6L L4 2555cc 156 CID	1983	Royal, Sport	US7114
5.9L V8 360 CID	1975-1978	Exc.Air Pump	US1053	2.6L L4 2555cc 156 CID	1984-1985	Custom, Royal, Sport	US7120
5.9L V8 360 CID	1975-1978	Air Pump, High performance	US1053H				
5.9L V8 360 CID	1975-1978	Exc.Air Pump, High performance	US1053H				
5.9L V8 5900cc 360 CID	1972-1973	Mexican Application	US1053				
6.6L V8 400 CID	1975-1978		US1040				
7.2L V8 440 CID	1975-1978		US1040				

WATER PUMPS

Engine	Years	Application Description	USMW
<b>DODGE (cont'd.)</b>			
<b>RAM 50 (cont'd.)</b>			
2.6L L4 2555cc 156 CID	1985	Custom, Royal; To 01/1985	<b>US7114</b>
2.6L L4 2555cc 156 CID	1986	Sport	<b>US7120</b>
2.6L L4 2555cc 156 CID	1987-1989	Base, Custom, Sport	<b>US7120</b>
3.0L V6 2972cc 181 CID	1990-1991	Base, LE, SE	<b>US7121</b>
3.0L V6 2972cc 181 CID	1990-1991	Base, LE, SE; With back plate housing	<b>US7121-2</b>
<b>RAM 1500</b>			
3.6L V6 3600cc 220 CID	2014	Mexican Application	<b>US8981</b>
3.6L V6 3605cc 220 CID	2015	Mexican Application	<b>US8981</b>
3.7L V6 226 CID	2002	SLT, ST	<b>US7163</b>
3.7L V6 226 CID	2003	Laramie, SLT, ST	<b>US7163</b>
3.7L V6 226 CID	2004-2007	ST	<b>US7163</b>
3.7L V6 226 CID	2008	ST, SXT	<b>US7163</b>
3.7L V6 226 CID	2009-2010	ST	<b>US7163</b>
3.7L V6 3701cc 226 CID	2013	Mexican Application	<b>US7163</b>
3.9L V6 3906cc 239 CID	1994-1996	Base	<b>US7160</b>
3.9L V6 3906cc 239 CID	1997-2001	Laramie, Sport, ST, WS	<b>US7160</b>
4.7L V8 287 CID	2002	SLT, ST	<b>US7163</b>
4.7L V8 287 CID	2003-2004	Laramie, SLT, ST	<b>US7163</b>
4.7L V8 287 CID	2005	SLT, ST	<b>US7163</b>
4.7L V8 287 CID	2006	Laramie, SLT, ST, TRX4	<b>US7163</b>
4.7L V8 287 CID	2007	SLT, ST, TRX4	<b>US7163</b>
4.7L V8 287 CID	2008	SLT, ST, SXT	<b>US7163</b>
4.7L V8 287 CID	2009-2010	SLT, ST, TRX, TRX4	<b>US7163</b>
5.2L V8 5211cc 318 CID	1994-1996	Base	<b>US7160</b>
5.2L V8 5211cc 318 CID	1997-2001	Laramie, Sport, ST	<b>US7160</b>
5.7L V8 345 CID	2003-2005	Laramie, SLT, ST	<b>US7168</b>
5.7L V8 345 CID	2006-2007	Laramie, SLT, Sport, ST, TRX4	<b>US7168</b>
5.7L V8 345 CID	2008	Laramie, SLT, ST, SXT	<b>US7168</b>
5.7L V8 345 CID	2009-2010	Laramie, SLT, Sport, ST, TRX, TRX4	<b>US6341</b>
5.9L V8 360 CID	1994-1996	Base	<b>US7160</b>
5.9L V8 360 CID	1997-2001	Laramie, Sport, ST	<b>US7160</b>
5.9L V8 360 CID	2002	SLT, ST	<b>US7160</b>
5.9L V8 360 CID	2003	Laramie, SLT, ST	<b>US7160</b>
<b>RAM 1500 VAN</b>			
3.9L V6 3906cc 239 CID	1999-2003	Base	<b>US7160</b>
5.2L V8 5211cc 318 CID	1999-2003	Base	<b>US7160</b>
5.9L V8 360 CID	1999-2003	Base	<b>US7160</b>
<b>RAM 2500</b>			
4.7L V8 4700cc 287 CID	2002-2009	Mexican Application	<b>US7163</b>
4.7L V8 4700cc 287 CID	2011-2012	Mexican Application	<b>US7163</b>
4.7L V8 4701cc 287 CID	2010	Mexican Application	<b>US7163</b>
5.2L V8 5211cc 318 CID	1994-1996	Base	<b>US7160</b>
5.2L V8 5215cc 318 CID	1997-2001	Mexican Application	<b>US7160</b>
5.7L V8 345 CID	2003	Laramie, SLT	<b>US7168</b>
5.7L V8 345 CID	2004	SLT, ST	<b>US7168</b>
5.7L V8 345 CID	2005	Laramie, SLT, ST	<b>US7168</b>
5.7L V8 345 CID	2006-2007	Laramie, Power Wagon, SLT, Sport, ST, TRX4	<b>US7168</b>
5.7L V8 345 CID	2008	Laramie, Power Wagon, SLT, ST, SXT	<b>US7168</b>
5.7L V8 345 CID	2009-2010	Laramie, Power Wagon, SLT, ST, SXT	<b>US6341</b>
5.7L V8 5654cc 345 CID	2010-2014	Mexican Application	<b>US8971</b>
5.7L V8 5654cc 345 CID	2015-2016	Mexican Application	<b>US6341</b>
5.9L L6 359 CID	1994-1998	Base	<b>US7145</b>
5.9L L6 359 CID	1994-2001		<b>US7145N</b>
5.9L L6 359 CID	1998-2002	Base	<b>US7145HN</b>
5.9L L6 359 CID	2003	Laramie, SLT, ST	<b>US7145</b>
5.9L L6 359 CID	2003-2009		<b>US7145HN</b>
5.9L L6 359 CID	2004	SLT, ST	<b>US7145</b>
5.9L L6 359 CID	2005	Laramie	<b>US7145</b>
5.9L L6 359 CID	2006-2007	Laramie, SLT, Sport, ST, TRX4	<b>US7145</b>
5.9L V8 360 CID	1994-2002	Base	<b>US7160</b>
6.7L L6 408 CID	2007	Laramie, SLT, ST	<b>US6222</b>
6.7L L6 408 CID	2008-2010	Laramie, SLT, ST, SXT	<b>US6222</b>
8.0L V10 7990cc 488 CID	1994-2002	Base	<b>US7169</b>
8.0L V10 7990cc 488 CID	2003	Laramie, SLT	<b>US7169</b>
<b>RAM 2500 VAN</b>			
3.9L V6 3906cc 239 CID	2001	Base	<b>US7160</b>
5.2L V8 5211cc 318 CID	1999-2003	Base	<b>US7160</b>
5.9L V8 360 CID	1999-2003	Base	<b>US7160</b>
<b>RAM 3500</b>			
5.7L V8 345 CID	2003	SLT, ST	<b>US7168</b>
5.7L V8 345 CID	2004-2005	Laramie, SLT, ST	<b>US7168</b>
5.7L V8 345 CID	2006-2007	Laramie, SLT, Sport, ST	<b>US7168</b>
5.7L V8 345 CID	2008	Laramie, SLT, ST, SXT	<b>US7168</b>
5.7L V8 345 CID	2009	Laramie, SLT, ST, SXT	<b>US6341</b>
5.9L L6 359 CID	1994-1998	Base	<b>US7145</b>
5.9L L6 359 CID	1994-2001		<b>US7145N</b>
5.9L L6 359 CID	1998-2002	Base	<b>US7145HN</b>
5.9L L6 359 CID	2003-2007		<b>US7145HN</b>
5.9L L6 359 CID	2004-2005	Laramie, SLT, ST	<b>US7145</b>
5.9L L6 359 CID	2006	Laramie, SLT, Sport, ST	<b>US7145</b>
5.9L L6 359 CID	2007	Laramie, SLT, Sport, ST, TRX4	<b>US7145</b>

Engine	Years	Application Description	USMW
<b>DODGE (cont'd.)</b>			
<b>RAM 3500 (cont'd.)</b>			
5.9L V8 360 CID	1994-2002	Base	<b>US7160</b>
6.7L L6 408 CID	2007	Laramie, SLT, Sport, ST	<b>US6222</b>
6.7L L6 408 CID	2008-2010	Laramie, SLT, ST, SXT	<b>US6222</b>
8.0L V10 7990cc 488 CID	1994-2002	Base	<b>US7169</b>
8.0L V10 7990cc 488 CID	2003	SLT, ST	<b>US7169</b>
<b>RAM 3500 VAN</b>			
5.2L V8 5211cc 318 CID	1999-2003	Base	<b>US7160</b>
5.9L V8 360 CID	1999-2003	Base	<b>US7160</b>
<b>RAM 4000</b>			
5.7L V8 5654cc 345 CID	2012-2014	Mexican Application	<b>US8971</b>
5.7L V8 5654cc 345 CID	2015	Mexican Application	<b>US7160</b>
5.7L V8 5700cc 350 CID	2002	Mexican Application	<b>US8971</b>
5.7L V8 5700cc 350 CID	2005-2006	Mexican Application	<b>US7168</b>
5.7L V8 5700cc 350 CID	2008-2011	Mexican Application	<b>US8971</b>
5.7L V8 5700cc 350 CID	2010	Mexican Application	<b>US6341</b>
5.9L V8 5900cc 360 CID	1997-2001	Mexican Application	<b>US7160</b>
6.7L L6 6700cc 409 CID	2010-2013	Mexican Application	<b>US6222</b>
<b>RAMCHARGER</b>			
3.7L L6 3687cc 225 CID	1975-1979		<b>US7100</b>
3.7L L6 3687cc 225 CID	1980	Base, SE	<b>US7100</b>
5.2L V8 5211cc 318 CID	1975-1978	Exc.Air Pump	<b>US1053</b>
5.2L V8 5211cc 318 CID	1975-1978	Exc.Air Pump, High performance	<b>US1053H</b>
5.2L V8 5211cc 318 CID	1975-1979	Air Pump	<b>US1053</b>
5.2L V8 5211cc 318 CID	1975-1979	Air Pump, High performance	<b>US1053H</b>
5.2L V8 5211cc 318 CID	1980	Base, SE	<b>US1053</b>
5.2L V8 5211cc 318 CID	1980	Base, SE; High performance	<b>US1053H</b>
5.2L V8 5211cc 318 CID	1981-1990	Base, Royal SE	<b>US1053</b>
5.2L V8 5211cc 318 CID	1981-1990	Base, Royal SE; High performance	<b>US1053H</b>
5.2L V8 5211cc 318 CID	1991	Base, Canyon Sport, Royal SE	<b>US1053</b>
5.2L V8 5211cc 318 CID	1991	Base, Canyon Sport, Royal SE; High performance	<b>US1053H</b>
5.2L V8 5211cc 318 CID	1992	Base, Canyon Sport, Royal SE	<b>US7159</b>
5.2L V8 5211cc 318 CID	1993	Base, Canyon Sport, Royal SE	<b>US7160</b>
5.2L V8 5215cc 318 CID	1999-2001	Mexican Application	<b>US7160</b>
5.9L V8 360 CID	1975-1978	Exc.Air Pump	<b>US1053</b>
5.9L V8 360 CID	1975-1978	Exc.Air Pump, High performance	<b>US1053H</b>
5.9L V8 360 CID	1975-1979	Air Pump	<b>US1053</b>
5.9L V8 360 CID	1975-1979	Air Pump, High performance	<b>US1053H</b>
5.9L V8 360 CID	1980	Base, SE	<b>US1053</b>
5.9L V8 360 CID	1980	Base, SE; High performance	<b>US1053H</b>
5.9L V8 360 CID	1981	Base, Royal SE	<b>US1053</b>
5.9L V8 360 CID	1981	Base, Royal SE; High performance	<b>US1053H</b>
5.9L V8 360 CID	1984-1990	Base, Royal SE	<b>US1053</b>
5.9L V8 360 CID	1984-1990	Base, Royal SE; High performance	<b>US1053H</b>
5.9L V8 360 CID	1991-1992	Base, Canyon Sport, Royal SE	<b>US1053</b>
5.9L V8 360 CID	1991-1992	Base, Canyon Sport, Royal SE; High performance	<b>US1053H</b>
5.9L V8 360 CID	1993	Base, Canyon Sport, Royal SE	<b>US7160</b>
5.9L V8 5900cc 360 CID	1980-1990	Mexican Application	<b>US1053</b>
5.9L V8 5900cc 360 CID	1994-2000	Mexican Application	<b>US7160</b>
6.6L V8 400 CID	1977-1978		<b>US1040</b>
7.2L V8 440 CID	1975-1978		<b>US1040</b>
<b>RAMPAGE</b>			
2.2L L4 135 CID	1982	High Line, Sport	<b>US7110</b>
2.2L L4 135 CID	1982	High Line, Sport; High performance	<b>US7110H</b>
2.2L L4 135 CID	1983-1984	2.2, Base	<b>US7110</b>
2.2L L4 135 CID	1983-1984	2.2, Base; High performance	<b>US7110H</b>
<b>RD200</b>			
5.2L V8 5211cc 318 CID	1980	Base	<b>US1053</b>
5.2L V8 5211cc 318 CID	1980	Base; High performance	<b>US1053H</b>
5.9L V8 360 CID	1980	Base	<b>US1053</b>
5.9L V8 360 CID	1980	Base; High performance	<b>US1053H</b>
<b>ROYAL MONACO</b>			
5.2L V8 318 CID	1975	Air Pump	<b>US1053</b>
5.2L V8 318 CID	1975	Exc.Air Pump	<b>US1053</b>
5.2L V8 318 CID	1975	Air Pump, High performance	<b>US1053H</b>
5.2L V8 318 CID	1975	Exc.Air Pump, High performance	<b>US1053H</b>
5.2L V8 318 CID	1977	Air Pump	<b>US1053</b>
5.2L V8 318 CID	1977	Exc.Air Pump	<b>US1053</b>
5.2L V8 318 CID	1977	Air Pump, High performance	<b>US1053H</b>
5.2L V8 318 CID	1977	Exc.Air Pump, High performance	<b>US1053H</b>
5.9L V8 360 CID	1975-1977	Air Pump	<b>US1053</b>
5.9L V8 360 CID	1975-1977	Exc.Air Pump	<b>US1053</b>
5.9L V8 360 CID	1975-1977	Air Pump, High performance	<b>US1053H</b>
5.9L V8 360 CID	1975-1977	Exc.Air Pump, High performance	<b>US1053H</b>
6.6L V8 400 CID	1975-1977		<b>US1040</b>
7.2L V8 440 CID	1975-1977		<b>US1040</b>
<b>SENECA</b>			
5.2L V8 5212cc 318 CID	1960-1961		<b>US919</b>



Engine	Years	Application Description	USMW	Engine	Years	Application Description	USMW
<b>DODGE (cont'd.)</b>				<b>DODGE (cont'd.)</b>			
<b>SHADOW</b>				<b>STRATUS (cont'd.)</b>			
2.2L L4 135 CID	1987	Base, Shelby	US7110	2.4L L4 2429cc 148 CID	1996	Base, ES; Hydraulic Tensioner	US7153
2.2L L4 135 CID	1987	Base, Shelby; High performance	US7110H	2.4L L4 2429cc 148 CID	1996	Base, ES; Mechanical Tensioner	US7156
2.2L L4 135 CID	1988	Base, ES, Shelby	US7110	2.4L L4 2429cc 148 CID	1997-1998	Base, ES	US7156
2.2L L4 135 CID	1988	Base, ES, Shelby; High performance	US7110H	2.4L L4 2429cc 148 CID	1999	Base	US7156
2.2L L4 135 CID	1989	Base, Shelby	US7122	2.4L L4 2429cc 148 CID	2000-2001	SE	US7156
2.2L L4 135 CID	1990	Base	US7127	2.4L L4 2429cc 148 CID	2001-2006	Mexican Application	US7156
2.2L L4 135 CID	1991-1992	America, High Line	US7127	2.4L L4 2429cc 148 CID	2002	ES, SE, SE Plus	US7156
2.2L L4 135 CID	1993	Base, High Line	US7127	2.4L L4 2429cc 148 CID	2003	ES, SE, SXT	US7156
2.2L L4 135 CID	1994	Base	US7127	2.4L L4 2429cc 148 CID	2004	SE, SXT	US7156
2.2L L4 2200cc 135 CID	1988	Mexican Application	US7110	2.4L L4 2429cc 148 CID	2005-2006	SXT	US7156
2.2L L4 2200cc 135 CID	1989	Mexican Application	US7122	2.5L V6 2497cc 152 CID	1995-2000	ES	US7152
2.2L L4 2200cc 135 CID	1990	Mexican Application	US7127	2.7L V6 2736cc 167 CID	2001	ES, SE	US7161
2.5L L4 2500cc 153 CID	1990	Mexican Application	US7127	2.7L V6 2736cc 167 CID	2002	ES, R/T, SE, SE Plus	US7161
2.5L L4 2500cc 153 CID	1993-1994	Mexican Application	US7127	2.7L V6 2736cc 167 CID	2003	ES, R/T, SE, SXT	US7161
2.5L L4 2507cc 153 CID	1988	Base	US7110	2.7L V6 2736cc 167 CID	2004	ES, R/T, SE	US7161
2.5L L4 2507cc 153 CID	1988	Base; High performance	US7110H	2.7L V6 2736cc 167 CID	2005-2006	R/T, SXT	US7161
2.5L L4 2507cc 153 CID	1989	Base, ES	US7122	3.0L V6 2972cc 181 CID	2001-2002	R/T, SE	US7152
2.5L L4 2507cc 153 CID	1990	Base, ES	US7127	3.0L V6 2972cc 181 CID	2003-2005	R/T	US7152
2.5L L4 2507cc 153 CID	1991	ES, High Line	US7127	<b>TRUCK</b>			
2.5L L4 2507cc 153 CID	1992	America, ES, High Line	US7127	5.2L V8 5212cc 318 CID	1960		US919
2.5L L4 2507cc 153 CID	1993	Base, ES, High Line	US7127	<b>VAN 1000</b>			
2.5L L4 2507cc 153 CID	1994	Base, ES	US7127	2.4L L4 2429cc 148 CID	2008-2009	Mexican Application	US9389
3.0L V6 2972cc 181 CID	1992	ES	US7121	<b>VERNA</b>			
3.0L V6 2972cc 181 CID	1992	ES; With back plate housing	US7121-2	1.5L L4 1508cc 92 CID	2004-2006	Mexican Application	US7115
3.0L V6 2972cc 181 CID	1993	ES, High Line	US7121	1.6L L4 1598cc 97 CID	2004-2006	Mexican Application	US9364
3.0L V6 2972cc 181 CID	1993	ES, High Line; With back plate housing	US7121-2	<b>VIPER</b>			
3.0L V6 2972cc 181 CID	1994	ES	US7121	8.0L V10 7990cc 488 CID	1992-1993		US7137
3.0L V6 2972cc 181 CID	1994	ES; With back plate housing	US7121-2	8.0L V10 7990cc 488 CID	1994-1996	Base	US7146
<b>SPIRIT</b>				<b>W100</b>			
2.2L L4 135 CID	1991-1992	R/T	US7139	3.7L L6 3687cc 225 CID	1975-1977		US7100
2.2L L4 2200cc 135 CID	1993	Mexican Application	US7127	3.7L L6 3687cc 225 CID	1986-1987	Custom	US7100
2.5L L4 2500cc 153 CID	1989	Mexican Application	US7122	3.9L V6 3906cc 239 CID	1989	Custom	US1053
2.5L L4 2500cc 153 CID	1990	Mexican Application	US7127	3.9L V6 3906cc 239 CID	1989	Custom; High performance	US1053H
2.5L L4 2500cc 153 CID	1993-1995	Mexican Application	US7127	5.2L V8 5211cc 318 CID	1975-1977	Air Pump	US1053
2.5L L4 2507cc 153 CID	1989	Base, ES, LE	US7122	5.2L V8 5211cc 318 CID	1975-1977	Exc.Air Pump	US1053
2.5L L4 2507cc 153 CID	1990-1992	Base, ES, LE	US7127	5.2L V8 5211cc 318 CID	1975-1977	Air Pump, High performance	US1053H
2.5L L4 2507cc 153 CID	1993	ES, High Line	US7127	5.2L V8 5211cc 318 CID	1975-1977	Exc.Air Pump, High performance	US1053H
2.5L L4 2507cc 153 CID	1994-1995	Base	US7127	5.2L V8 5211cc 318 CID	1986-1989	Custom	US1053
3.0L V6 2972cc 181 CID	1989	ES	US7121	5.2L V8 5211cc 318 CID	1986-1989	Custom; High performance	US1053H
3.0L V6 2972cc 181 CID	1989	ES; With back plate housing	US7121-2	5.9L V8 360 CID	1975-1977	Air Pump	US1053
3.0L V6 2972cc 181 CID	1990-1992	Base, ES, LE	US7121	5.9L V8 360 CID	1975-1977	Exc.Air Pump	US1053
3.0L V6 2972cc 181 CID	1990-1992	Base, ES, LE; With back plate housing	US7121-2	5.9L V8 360 CID	1975-1977	Air Pump, High performance	US1053H
3.0L V6 2972cc 181 CID	1993	ES, High Line	US7121	5.9L V8 360 CID	1975-1977	Exc.Air Pump, High performance	US1053H
3.0L V6 2972cc 181 CID	1993	ES, High Line; With back plate housing	US7121-2	5.9L V8 360 CID	1986-1988	Custom	US1053
3.0L V6 2972cc 181 CID	1994-1995	Base	US7121	5.9L V8 360 CID	1986-1988	Custom; High performance	US1053H
3.0L V6 2972cc 181 CID	1994-1995	Base; With back plate housing	US7121-2	6.6L V8 400 CID	1975-1977		US1040
<b>SPRINTER 2500</b>				<b>W100 PICKUP</b>			
2.7L L5 2687cc 165 CID	2003	Base	US6008	3.8L L6 3770cc 230 CID	1958-1959		US713
2.7L L5 2687cc 165 CID	2004-2006	Base	US6007	5.2L V8 318 CID	1968-1969		US919
3.0L V6 2987cc	2007-2009	Base	US6155	5.2L V8 5212cc 318 CID	1968-1969		US919
<b>SPRINTER 3500</b>				<b>W100 SERIES</b>			
2.7L L5 2687cc 165 CID	2003	Base	US6008	5.2L V8 5212cc 318 CID	1960-1967		US919
2.7L L5 2687cc 165 CID	2004-2006	Base	US6007	<b>W150</b>			
3.0L V6 2987cc	2007-2009	Base	US6155	3.7L L6 3687cc 225 CID	1978-1979		US7100
<b>ST. REGIS</b>				3.7L L6 3687cc 225 CID	1980-1987	Base	US7100
3.7L L6 3687cc 225 CID	1979		US7100	3.9L V6 3906cc 239 CID	1989	Base	US1053
3.7L L6 3687cc 225 CID	1980-1981	Base	US7100	3.9L V6 3906cc 239 CID	1989	Base; High performance	US1053H
5.2L V8 318 CID	1979	Air Pump	US1053	3.9L V6 3906cc 239 CID	1990-1991	Base, S	US1053
5.2L V8 318 CID	1979	Air Pump, High performance	US1053H	3.9L V6 3906cc 239 CID	1990-1991	Base, S; High performance	US1053H
5.2L V8 318 CID	1980-1981	Base	US1053	3.9L V6 3906cc 239 CID	1992	Base	US7159
5.2L V8 318 CID	1980-1981	Base; High performance	US1053H	3.9L V6 3906cc 239 CID	1993	Base	US7160
5.9L V8 360 CID	1979	Air Pump	US1053	5.2L V8 5211cc 318 CID	1977-1978	Exc.Air Pump	US1053
5.9L V8 360 CID	1979	Air Pump, High performance	US1053H	5.2L V8 5211cc 318 CID	1977-1978	Exc.Air Pump, High performance	US1053H
5.9L V8 360 CID	1980	Base	US1053	5.2L V8 5211cc 318 CID	1977-1979	Air Pump	US1053
5.9L V8 360 CID	1980	Base; High performance	US1053H	5.2L V8 5211cc 318 CID	1977-1979	Air Pump, High performance	US1053H
<b>STEALTH</b>				5.2L V8 5211cc 318 CID	1980-1989	Base	US1053
3.0L V6 2972cc 181 CID	1991-1993	Base, ES, R/T, R/T Turbo	US7121	5.2L V8 5211cc 318 CID	1980-1989	Base; High performance	US1053H
3.0L V6 2972cc 181 CID	1991-1993	Base, ES, R/T, R/T Turbo; With back plate housing	US7121-2	5.2L V8 5211cc 318 CID	1990-1991	Base, S	US1053
3.0L V6 2972cc 181 CID	1994-1996	Base	US7121	5.2L V8 5211cc 318 CID	1990-1991	Base, S; High performance	US1053H
3.0L V6 2972cc 181 CID	1994-1996	Base; With back plate housing	US7121-2	5.2L V8 5211cc 318 CID	1992	Base	US7159
3.0L V6 2972cc 181 CID	1994-1996	R/T, R/T Turbo	US7129	5.2L V8 5211cc 318 CID	1993	Base	US7160
<b>STRATUS</b>				5.9L V8 360 CID	1977-1978	Exc.Air Pump	US1053
2.0L L4 1996cc 122 CID	1995-1997	Base, ES	US7150	5.9L V8 360 CID	1977-1978	Exc.Air Pump, High performance	US1053H
2.0L L4 1996cc 122 CID	1998-1999	Base	US7150	5.9L V8 360 CID	1977-1979	Air Pump	US1053
2.0L L4 1996cc 122 CID	2000	SE	US7150	5.9L V8 360 CID	1977-1979	Air Pump, High performance	US1053H
2.0L L4 1996cc 122 CID	2004-2006	Mexican Application	US7156	5.9L V8 360 CID	1980-1981	Base	US1053
2.0L L4 1998cc 122 CID	2001-2003	Mexican Application	US7156	5.9L V8 360 CID	1980-1981	Base; High performance	US1053H
2.4L L4 2351cc	2001-2002	SE	US9399	5.9L V8 360 CID	1984-1990	Base	US1053
2.4L L4 2351cc	2003	SE, SXT	US9399	5.9L V8 360 CID	1984-1990	Base; High performance	US1053H
2.4L L4 2351cc	2004-2005	SXT	US9399	<b>WATER PUMPS</b>			
2.4L L4 2426cc 148 CID	1998-2000	Mexican Application	US7156				
2.4L L4 2429cc 148 CID	1995	Base	US7153				



# WATER PUMP APPLICATION GUIDE



Engine	Years	Application Description	USMW
<b>DODGE (cont'd.)</b>			
<b>W150 (cont'd.)</b>			
5.9L V8 360 CID	1991	Base, S	US1053
5.9L V8 360 CID	1991	Base, S; High performance	US1053H
5.9L V8 360 CID	1993	Base	US7160
<b>W200</b>			
3.7L L6 3687cc 225 CID	1975-1979		US7100
3.7L L6 3687cc 225 CID	1980	Base	US7100
5.2L V8 318 CID	1975	Air Pump	US1053
5.2L V8 318 CID	1975	Exc.Air Pump	US1053
5.2L V8 318 CID	1975	Air Pump, High performance	US1053H
5.2L V8 318 CID	1975	Exc.Air Pump, High performance	US1053H
5.2L V8 5211cc 318 CID	1975-1978	Air Pump	US1053
5.2L V8 5211cc 318 CID	1975-1978	Exc.Air Pump, High performance	US1053H
5.2L V8 5211cc 318 CID	1975-1979	Air Pump	US1053
5.2L V8 5211cc 318 CID	1975-1979	Air Pump, High performance	US1053H
5.2L V8 5211cc 318 CID	1980	Base	US1053
5.2L V8 5211cc 318 CID	1980	Base; High performance	US1053H
5.9L V8 360 CID	1975-1978	Exc.Air Pump	US1053
5.9L V8 360 CID	1975-1978	Exc.Air Pump, High performance	US1053H
5.9L V8 360 CID	1975-1979	Air Pump	US1053
5.9L V8 360 CID	1975-1979	Air Pump, High performance	US1053H
5.9L V8 360 CID	1980	Base	US1053
5.9L V8 360 CID	1980	Base; High performance	US1053H
6.6L V8 400 CID	1976-1978		US1040
7.2L V8 440 CID	1975-1978		US1040
<b>W200 PICKUP</b>			
3.8L L6 3770cc 230 CID	1958-1959		US713
5.2L V8 318 CID	1969		US919
5.2L V8 5212cc 318 CID	1968-1969		US919
<b>W200 SERIES</b>			
5.2L V8 5212cc 318 CID	1960-1967		US919
<b>W250</b>			
3.7L L6 3700cc 225 CID	1985-1987	Mexican Application	US7100
5.2L V8 5211cc 318 CID	1981-1991	Base	US1053
5.2L V8 5211cc 318 CID	1981-1991	Base; High performance	US1053H
5.2L V8 5211cc 318 CID	1992	Base	US7159
5.2L V8 5211cc 318 CID	1993	Base	US7160
5.9L L6 359 CID	1989-1993	Base	US7145
5.9L V8 360 CID	1981-1982	Base	US1053
5.9L V8 360 CID	1981-1982	Base; High performance	US1053H
5.9L V8 360 CID	1984-1992	Base	US1053
5.9L V8 360 CID	1984-1992	Base; High performance	US1053H
5.9L V8 360 CID	1993	Base	US7160
5.9L V8 5900cc 360 CID	1989-1990	Mexican Application	US1053
<b>W300</b>			
3.7L L6 3687cc 225 CID	1975-1978		US7100
5.2L V8 5211cc 318 CID	1975-1978	Air Pump	US1053
5.2L V8 5211cc 318 CID	1975-1978	Exc.Air Pump	US1053
5.2L V8 5211cc 318 CID	1975-1978	Air Pump, High performance	US1053H
5.2L V8 5211cc 318 CID	1975-1978	Exc.Air Pump, High performance	US1053H
5.2L V8 5211cc 318 CID	1980	Base	US1053
5.2L V8 5211cc 318 CID	1980	Base; High performance	US1053H
5.9L V8 360 CID	1975-1978	Exc.Air Pump	US1053
5.9L V8 360 CID	1975-1978	Exc.Air Pump, High performance	US1053H
5.9L V8 360 CID	1975-1979	Air Pump	US1053
5.9L V8 360 CID	1975-1979	Air Pump, High performance	US1053H
5.9L V8 360 CID	1980	Base	US1053
5.9L V8 360 CID	1980	Base; High performance	US1053H
6.6L V8 400 CID	1976-1978		US1040
7.2L V8 440 CID	1975-1978		US1040
<b>W300 PICKUP</b>			
3.8L L6 3770cc 230 CID	1958-1959		US713
5.2L V8 318 CID	1968-1969		US919
5.2L V8 5212cc 318 CID	1968-1969		US919
<b>W300 SERIES</b>			
5.2L V8 5212cc 318 CID	1960-1967		US919
<b>W350</b>			
5.2L V8 5211cc 318 CID	1982-1983	Base	US1053
5.2L V8 5211cc 318 CID	1982-1983	Base; High performance	US1053H
5.9L L6 359 CID	1989-1993	Base	US7145
5.9L V8 360 CID	1981-1992	Base	US1053
5.9L V8 360 CID	1981-1992	Base; High performance	US1053H
5.9L V8 360 CID	1993	Base	US7160
<b>WM300 POWER WAGON</b>			
3.8L L6 3770cc 230 CID	1958-1960		US713
5.2L V8 5212cc 318 CID	1960-1962		US919

Engine	Years	Application Description	USMW
<b>EAGLE (cont'd.)</b>			
<b>PREMIER</b>			
2.5L L4 150 CID	1988-1989	LX	US3412
3.0L V6 2972cc 182 CID	1988-1989	ES, LX	US3411
3.0L V6 2972cc 182 CID	1990	ES, ES Limited, LX	US3411
3.0L V6 2972cc 182 CID	1991	ES, ES Limited; (Z7X-711)	US3411
<b>SUMMIT</b>			
1.5L L4 1468cc 90 CID	1989	DL, LX	US7115
1.5L L4 1468cc 90 CID	1990	DL, ES, LX	US7115
1.5L L4 1468cc 90 CID	1991-1992	Base, ES	US7115
1.5L L4 1468cc 90 CID	1993-1994	DL, ES	US7115
1.5L L4 1468cc 90 CID	1995-1996	DL, ESi	US7115
1.6L L4 1597cc 98 CID	1989-1990	LX	US7131
1.8L L4 1834cc 112 CID	1992	Base, DL, LX	US7135
1.8L L4 1834cc 112 CID	1993	Base, DL, ES	US7135
1.8L L4 1834cc 112 CID	1994	DL, ES, ESi, LX	US7135
1.8L L4 1834cc 112 CID	1995	DL, ESi, LX	US7135
1.8L L4 1834cc 112 CID	1996	DL, LX	US7135
2.4L L4 2351cc	1992	Base, DL, LX	US9168
2.4L L4 2351cc	1993-1996	Base, DL, LX	US7148
<b>TALON</b>			
1.8L L4 1755cc 107 CID	1993-1994	DL	US7108
2.0L L4 1997cc 122 CID	1990-1992	Base, TSi	US9212
2.0L L4 1997cc 122 CID	1993-1994	ES, TSi	US9212
2.0L L4 1997cc 122 CID	1995	ESi	US7150
2.0L L4 1997cc 122 CID	1995-1998	TSi	US7148
2.0L L4 1997cc 122 CID	1996-1998	Base, ESi	US7150
<b>VISION</b>			
3.3L V6 3301cc 201 CID	1993-1997	ESi	US7140
3.5L V6 3497cc 215 CID	1993-1994	TSi	US7141
3.5L V6 3497cc 215 CID	1995-1996	TSi	US7151
3.5L V6 3497cc 215 CID	1997	ESi, TSi; 3 Bolt Pattern	US7151
3.5L V6 3497cc 215 CID	1997	ESi, TSi; 6 Bolt Pattern	US7158
<b>EDSEL</b>			
<b>RANGER</b>			
4.8L V8 4786cc 292 CID	1959-1960		US488
<b>FIAT</b>			
<b>124</b>			
1.2L L4 1197cc 73 CID	1966-1969		US9203
1.4L L4 1438cc 88 CID	1970-1973		US9203
1.6L L4 1593cc	1974		US9003
1.6L L4 1608cc	1971-1973	Spider	US9203
1.8L L4 1756cc	1974-1978		US9003
2.0L L4 1995cc	1979-1982		US9003
<b>124 SPIDER</b>			
1.4L L4 1368cc 83 CID	2017	Abarth, Classica, Lusso	US8136
<b>128</b>			
1.1L L4 1116cc	1971-1973		US9084
1.3L L4 1290cc	1973-1979		US9084
<b>131</b>			
1.8L L4 1756cc	1975-1978		US9003
<b>500</b>			
1.4L L4 1368cc 83 CID	2012	Abarth, c Gucci, c Lounge, c Pop, Gucci, Lounge, Pop, Sport	US8136
1.4L L4 1368cc 83 CID	2013-2015	Abarth, Abarth Cabrio, c Lounge, c Pop, Lounge, Pop, Sport, Turbo	US8136
1.4L L4 1368cc 83 CID	2016	Abarth, Abarth Cabrio, c Easy, c Lounge, c Pop, Easy, Lounge, Pop, Sport, Turbo	US8136
1.4L L4 1368cc 83 CID	2017	Abarth, Abarth Cabrio, c Lounge, c Pop, Lounge, Pop	US8136
<b>500L</b>			
1.4L L4 1368cc 83 CID	2014	Easy, Lounge, Pop, Trekking	US8136
1.4L L4 1368cc 83 CID	2016	Easy, Lounge, Pop, Trekking, Urbana	US8136
1.4L L4 1368cc 83 CID	2017	Lounge, Pop, Trekking, Urbana	US8136
<b>500X</b>			
1.4L L4 1368cc 83 CID	2016-2017	Pop	US8136
2.4L L4 2360cc 144 CID	2016	Easy, Lounge, Pop, Trekking, Trekking Plus	US6038
2.4L L4 2360cc 144 CID	2017-2018	Lounge, Pop, Trekking	US6038
<b>BRAVA</b>			
2.0L L4 1995cc	1978-1981		US9003
<b>IDEA</b>			
1.8L L4 1796cc 110 CID	2008	Adventure S	US8938
<b>IDEA ADVENTURE</b>			
1.8L L4 1796cc 110 CID	2008-2009	Mexican Application	US8938
<b>PALIO</b>			
1.6L L4 1596cc 97 CID	2004		US8948
1.8L L4 1796cc 110 CID	2005		US8938

Engine	Years	Application Description	USMW	Engine	Years	Application Description	USMW
<b>FIAT (cont'd.)</b>				<b>FORD (cont'd.)</b>			
<b>PALIO (cont'd.)</b>				<b>BRONCO (cont'd.)</b>			
1.8L L4 1796cc 110 CID	2005-2006		<b>US8948</b>	4.9L L6 4917cc 300 CID	1983	Custom, XLS, XLT Lariat	<b>US4020</b>
1.8L L4 1796cc 110 CID	2006-2008	SFI	<b>US8938</b>	4.9L L6 4917cc 300 CID	1984	Custom, XLT	<b>US4020</b>
1.8L L4 1796cc 110 CID	2007-2008		<b>US8938</b>	4.9L L6 4917cc 300 CID	1985-1986	Custom, Eddie Bauer, XLT	<b>US4020</b>
1.8L L4 1796cc 110 CID	2010	ST	<b>US8938</b>	4.9L L6 4917cc 300 CID	1987-1989	Custom, Eddie Bauer, XLT	<b>US4048</b>
<b>PANDA</b>				4.9L L6 4917cc 300 CID	1990-1991	Custom, Eddie Bauer, XL, XLT	<b>US4048</b>
1.2L L4 1242cc 76 CID	2007-2008		<b>US8945</b>	4.9L L6 4917cc 300 CID	1992	Eddie Bauer, XL, XLT, XLT Nite	<b>US4048</b>
1.2L L4 1242cc 76 CID	2011-2012		<b>US8945</b>	5.0L V8 302 CID	1975-1977		<b>US1028</b>
<b>PUNTO</b>				5.0L V8 302 CID	1975-1977	High performance	<b>US1028H</b>
1.4L L4 1368cc 83 CID	2007-2008	SFI	<b>US8946</b>	5.0L V8 302 CID	1980-1981	Custom, Ranger XLT; WINDSOR	<b>US953</b>
1.4L L4 1368cc 83 CID	2007-2009		<b>US8946</b>	5.0L V8 302 CID	1980-1981	Custom, Ranger XLT; High performance	<b>US953H</b>
1.4L L4 1368cc 83 CID	2008	FBF	<b>US8946</b>	5.0L V8 302 CID	1982-1983	Custom, XLS, XLT Lariat; WINDSOR	<b>US953</b>
<b>STRADA</b>				5.0L V8 302 CID	1982-1983	Custom, XLS, XLT Lariat; High performance	<b>US953H</b>
1.5L L4 1498cc	1979		<b>US8944</b>	5.0L V8 302 CID	1984	Custom, XLT; WINDSOR	<b>US953</b>
1.5L L4 1498cc	1979-1982	W/O AIR	<b>US9084</b>	5.0L V8 302 CID	1984	Custom, XLT; High performance	<b>US953H</b>
1.5L L4 1498cc	1979-1982	A/C	<b>US9085</b>	5.0L V8 302 CID	1985-1986	Custom, Eddie Bauer, XLT; WINDSOR	<b>US953</b>
1.8L L4 1796cc 110 CID	2007-2008	Adventure	<b>US8938</b>	5.0L V8 302 CID	1985-1986	Custom, Eddie Bauer, XLT; High performance	<b>US953H</b>
1.8L L4 1796cc 110 CID	2007-2008	Adventure; SFI	<b>US8938</b>	5.0L V8 302 CID	1987-1989	Custom, Eddie Bauer, XLT	<b>US4044</b>
1.8L L4 1796cc 110 CID	2010	Adventure, Trekking	<b>US8938</b>	5.0L V8 302 CID	1987-1989	Custom, Eddie Bauer, XLT; High performance	<b>US4044H</b>
<b>X-1/9</b>				5.0L V8 302 CID	1990-1991	Custom, Eddie Bauer, XL, XLT	<b>US4044</b>
1.3L L4 1290cc	1974-1978		<b>US9084</b>	5.0L V8 302 CID	1990-1991	Custom, Eddie Bauer, XL, XLT; High performance	<b>US4044H</b>
1.5L L4 1498cc	1979-1982	W/O AIR	<b>US9084</b>	5.0L V8 302 CID	1992	Custom, Eddie Bauer, XL, XLT, XLT Nite	<b>US4044</b>
1.5L L4 1498cc	1979-1982	A/C	<b>US9085</b>	5.0L V8 302 CID	1992	Custom, Eddie Bauer, XL, XLT, XLT Nite; High performance	<b>US4044H</b>
<b>FORD</b>				5.0L V8 302 CID	1993	Custom, Eddie Bauer, XL, XLT Lariat	<b>US4044</b>
<b>AEROSTAR</b>				5.0L V8 302 CID	1993	Custom, Eddie Bauer, XL, XLT Lariat; High performance	<b>US4044H</b>
2.3L L4 140 CID	1986-1987	Base, XL, XLT	<b>US4054</b>	5.0L V8 302 CID	1994	Eddie Bauer, XL, XLT	<b>US4044</b>
2.8L V6 171 CID	1986	Base, XL, XLT	<b>US4023</b>	5.0L V8 302 CID	1994	Eddie Bauer, XL, XLT; High performance	<b>US4044H</b>
3.0L V6 2986cc 182 CID	1986-1987	Base, XL, XLT	<b>US4039</b>	5.0L V8 302 CID	1995-1996	Eddie Bauer, XL, XLT, XLT Sport	<b>US4044</b>
3.0L V6 2986cc 182 CID	1988	Base, Eddie Bauer, XL, XLT	<b>US4039</b>	5.0L V8 302 CID	1995-1996	Eddie Bauer, XL, XLT, XLT Sport; High performance	<b>US4044H</b>
3.0L V6 2986cc 182 CID	1989-1990	Base, Eddie Bauer, XL, XL Plus, XLT, XLT Plus	<b>US4039</b>	5.8L V8 351 CID	1978-1979	MODIFIED	<b>US932</b>
3.0L V6 2986cc 182 CID	1991	Base, Eddie Bauer, XL, XL Plus, XL Sport, XLT, XLT Plus, XLT Sport	<b>US4039</b>	5.8L V8 351 CID	1978-1979	WINDSOR	<b>US953</b>
3.0L V6 2986cc 182 CID	1992-1994	Base, XL, XL Plus, XL Sport, XLT, XLT Plus, XLT Sport	<b>US4039</b>	5.8L V8 351 CID	1978-1979	High performance	<b>US953H</b>
3.0L V6 2986cc 182 CID	1995-1997	Base, XLT, XLT Plus, XLT Sport	<b>US4095</b>	5.8L V8 351 CID	1980-1981	Custom, Ranger XLT; MODIFIED	<b>US932</b>
4.0L V6 245 CID	1990	Base, Eddie Bauer, XL, XL Plus, XLT, XLT Plus	<b>US4060</b>	5.8L V8 351 CID	1980-1981	Custom, Ranger XLT; WINDSOR	<b>US953</b>
4.0L V6 245 CID	1991-1994	Base, Eddie Bauer, XL, XL Plus, XL Sport, XLT, XLT Plus, XLT Sport	<b>US4060</b>	5.8L V8 351 CID	1980-1981	Custom, Ranger XLT; High performance	<b>US953H</b>
4.0L V6 245 CID	1995-1997	Base, XLT, XLT Plus, XLT Sport	<b>US4060</b>	5.8L V8 351 CID	1982	Custom, XLS, XLT Lariat; MODIFIED	<b>US932</b>
<b>ASPIRE</b>				5.8L V8 351 CID	1982-1983	Custom, XLS, XLT Lariat; WINDSOR	<b>US953</b>
1.3L L4 1295cc	1994-1995	Base, SE	<b>US4049</b>	5.8L V8 351 CID	1982-1983	Custom, XLS, XLT Lariat; High performance	<b>US953H</b>
1.3L L4 1295cc	1996-1997	Base	<b>US4049</b>	5.8L V8 351 CID	1984	Custom, XLT; WINDSOR	<b>US953</b>
<b>B100</b>				5.8L V8 351 CID	1984	Custom, XLT; High performance	<b>US953H</b>
4.7L V8 4700cc 289 CID	1973-1974	Mexican Application	<b>US953</b>	5.8L V8 351 CID	1985-1987	Custom, Eddie Bauer, XLT; WINDSOR	<b>US953</b>
4.7L V8 4700cc 289 CID	1973-1974	Mexican Application	<b>US1028</b>	5.8L V8 351 CID	1985-1987	Custom, Eddie Bauer, XLT; High performance	<b>US953H</b>
4.7L V8 4700cc 289 CID	1979	Mexican Application	<b>US953</b>	5.8L V8 351 CID	1988-1989	Custom, Eddie Bauer, XLT	<b>US4044</b>
5.0L V8 5000cc 302 CID	1973-1974	Mexican Application	<b>US953</b>	5.8L V8 351 CID	1988-1989	Custom, Eddie Bauer, XLT; High performance	<b>US4044H</b>
5.0L V8 5000cc 302 CID	1973-1974	Mexican Application	<b>US1028</b>	5.8L V8 351 CID	1990-1991	Custom, Eddie Bauer, XL, XLT	<b>US4044</b>
5.0L V8 5000cc 302 CID	1979-1981	Mexican Application	<b>US953</b>	5.8L V8 351 CID	1990-1991	Custom, Eddie Bauer, XL, XLT; High performance	<b>US4044H</b>
<b>B150</b>				5.8L V8 351 CID	1992	Custom, Eddie Bauer, XL, XLT, XLT Nite	<b>US4044</b>
3.8L V6 3800cc 232 CID	1982-1985	Mexican Application	<b>US953</b>	5.8L V8 351 CID	1992	Custom, Eddie Bauer, XL, XLT, XLT Nite; High performance	<b>US4044H</b>
4.7L V8 4700cc 289 CID	1975-1978	Mexican Application	<b>US953</b>	5.8L V8 351 CID	1993	Custom, Eddie Bauer, XL, XLT Lariat	<b>US4044</b>
5.0L V8 5000cc 302 CID	1975-1978	Mexican Application	<b>US953</b>	5.8L V8 351 CID	1993	Custom, Eddie Bauer, XL, XLT Lariat; High performance	<b>US4044H</b>
5.0L V8 5000cc 302 CID	1982-1985	Mexican Application	<b>US953</b>	5.8L V8 351 CID	1994	Eddie Bauer, XL, XLT	<b>US4044</b>
<b>B200</b>				5.8L V8 351 CID	1994	Eddie Bauer, XL, XLT; High performance	<b>US4044H</b>
5.0L V8 5000cc 302 CID	1985-1986	Mexican Application	<b>US953</b>	5.8L V8 351 CID	1995-1996	Eddie Bauer, XL, XLT, XLT Sport	<b>US4044</b>
5.0L V8 5000cc 302 CID	1987-1992	Mexican Application	<b>US4044</b>	5.8L V8 351 CID	1995-1996	Eddie Bauer, XL, XLT, XLT Sport; High performance	<b>US4044H</b>
<b>B600</b>				6.6L V8 400 CID	1978-1979	MODIFIED	<b>US932</b>
6.1L V8 370 CID	1980-1989		<b>US4037</b>	<b>BRONCO II</b>			
6.6L L6 401 CID	1987-1990		<b>US4062</b>	2.8L V6 171 CID	1984-1985	Base, Eddie Bauer, XLS, XLT	<b>US4023</b>
7.0L V8 429 CID	1988-1989		<b>US4037</b>	2.9L V6 177 CID	1986	Base, Eddie Bauer, XLT	<b>US4042</b>
<b>B700</b>				2.9L V6 177 CID	1987	Eddie Bauer, XL, XLT	<b>US4042</b>
6.1L V8 370 CID	1980-1989		<b>US4037</b>	2.9L V6 177 CID	1988	Eddie Bauer, XL, XL Sport, XLT	<b>US4042</b>
6.6L L6 401 CID	1987-1990		<b>US4062</b>	2.9L V6 177 CID	1989-1990	Eddie Bauer, XL, XL Sport, XLT, XLT Plus	<b>US4042</b>
7.0L V8 429 CID	1980-1989		<b>US4037</b>	<b>C600</b>			
7.8L L6 473 CID	1987		<b>US4062</b>	6.1L V8 370 CID	1980-1986		<b>US4037</b>
7.8L L6 473 CID	1990		<b>US4062</b>	<b>C700</b>			
<b>B-100</b>				6.1L V8 370 CID	1980-1986		<b>US4037</b>
5.0L V8 302 CID	1979	WINDSOR	<b>US953</b>	7.0L V8 429 CID	1980-1986		<b>US4037</b>
<b>BRONCO</b>				<b>C800</b>			
2.8L L6 170 CID	1967-1972		<b>US1044</b>	6.1L V8 370 CID	1980-1986		<b>US4037</b>
2.8L L6 2786cc 170 CID	1966-1972		<b>US1044</b>	<b>C600</b>			
2.9L L6 2901cc 177 CID	1997	Mexican Application	<b>US4042</b>	6.1L V8 370 CID	1980-1986		<b>US4037</b>
3.3L L6 200 CID	1973-1974		<b>US1044</b>	7.0L V8 429 CID	1980-1986		<b>US4037</b>
3.3L L6 3277cc 200 CID	1973-1974		<b>US1044</b>	<b>C800</b>			
3.3L L6 3278cc 200 CID	1973-1974		<b>US1044</b>	6.1L V8 370 CID	1980-1986		<b>US4037</b>
4.9L L6 4917cc 300 CID	1980-1981	Custom, Ranger XLT	<b>US4030N</b>				
4.9L L6 4917cc 300 CID	1982	Custom, XLS, XLT Lariat	<b>US4030N</b>				

WATER PUMPS



Engine	Years	Application Description	USMW	Engine	Years	Application Description	USMW
<b>FORD (cont'd.)</b>				<b>FORD (cont'd.)</b>			
<b>C800 (cont'd.)</b>				<b>COURIER (cont'd.)</b>			
7.0L V8 429 CID	1980-1986		US4037	1.6L L4 1598cc 98 CID	2010	L, XL	US8931
<b>CF6000</b>				1.6L L4 1600cc 98 CID	2003-2007		US8931
6.6L L6 401 CID	1986-1990		US4062	1.6L L4 1600cc 98 CID	2011	L	US8931
<b>CF7000</b>				1.6L L4 1600cc 98 CID	2012	XL	US8931
5.9L L6 359 CID	1993-1997		US7145N	1.8L L4 110 CID	1975-1979		US1042
6.6L L6 401 CID	1986-1990		US4062	2.0L L4 1989cc 122 CID	1979		US1042
<b>CF8000</b>				2.0L L4 1989cc 122 CID	1981-1982	Base, XLT	US1042
6.6L L6 401 CID	1987		US4062	2.3L L4 140 CID	1977-1979		US4005
7.8L L6 473 CID	1987-1990		US4062	2.3L L4 140 CID	1980-1982	Base, XLT	US4005
<b>CLUB WAGON</b>				<b>COURIER SEDAN DELIVERY</b>			
2.4L L6 2360cc 144 CID	1962-1964		US1044	3.9L V8 3917cc 239 CID	1954		US488
2.8L L6 170 CID	1962-1963		US1044	4.4L V8 4458cc 272 CID	1955-1957		US488
2.8L L6 170 CID	1966-1967		US1044	4.8L V8 4786cc 292 CID	1957-1958		US488
2.8L L6 2786cc 170 CID	1962-1967		US1044	<b>CRESTLINE</b>			
<b>CONTOUR</b>				<b>CROWN VICTORIA</b>			
2.0L L4 1989cc 121 CID	1995	GL, GL Sport, LX, LX Sport	US4088	4.6L V8 281 CID	1992	Base, LX, S, Touring Sedan	US4066
2.0L L4 1989cc 121 CID	1996	GL, LX, Sport	US4088	4.6L V8 281 CID	1993	Base, LX, Police Interceptor, S	US4066
2.0L L4 1989cc 121 CID	1997	Base, GL, LX	US4088	4.6L V8 281 CID	1994	Base, LX, Police Interceptor, S; From 04/94	US4066
2.0L L4 1989cc 121 CID	1998	Base, GL, LX; From 12/1997	US4115	4.6L V8 281 CID	1994	Base, LX, Police Interceptor, S; To 03/94	US4066
2.0L L4 1989cc 121 CID	1998	Base, GL, LX; To 12/1997	US4115	4.6L V8 281 CID	1995-1997	Base, LX, Police Interceptor, S	US4066
2.0L L4 1989cc 121 CID	1998	GL, LX, SE	US4115	4.6L V8 281 CID	1996	Base, LX, Police Interceptor, S; From 03/96	US4066
2.0L L4 1989cc 121 CID	1999-2000	LX, SE	US4115	4.6L V8 281 CID	1996	Base, LX, Police Interceptor, S; To 03/96	US4066
2.5L V6 2450cc 155 CID	1995	GL, GL Sport, LX, LX Sport, SE	US4091	4.6L V8 281 CID	1996	Base, LX, Police Interceptor, S; Pump Length: long	US4113
2.5L V6 2450cc 155 CID	1995	GL, GL Sport, LX, LX Sport, SE; Includes back housing	US4091-2	4.6L V8 281 CID	1998	Base, LX, Police Interceptor, S; Pump Length: long	US4113
2.5L V6 2450cc 155 CID	1996-1997	GL, LX, SE, Sport	US4091	4.6L V8 281 CID	1999-2000	Base, LX, Police Interceptor, S; Exc.Police, Pump Length: long	US4113
2.5L V6 2450cc 155 CID	1996-1997	GL, LX, SE, Sport; Includes back housing	US4091-2	4.6L V8 281 CID	1999-2001	Base, LX, Police Interceptor, S; Police, Pump Length: long	US4113
2.5L V6 2450cc 155 CID	1998	GL, LX, SE, SVT	US4091	4.6L V8 281 CID	2001	Base, LX, Police Interceptor, S; Exc.Police, Long Housing, Pump Length: long	US4113
2.5L V6 2450cc 155 CID	1998	GL, LX, SE, SVT; Includes back housing	US4091-2	4.6L V8 281 CID	2001	Base, LX, Police Interceptor, S; Exc.Police, Short Housing	US4128
2.5L V6 2450cc 155 CID	1999	LX, SE	US4091	4.6L V8 281 CID	2002	Base, LX, Police Interceptor, S; Exc.Police, Long Housing, Pump Length: long	US4113
2.5L V6 2450cc 155 CID	1999	LX, SE; Includes back housing	US4091-2	4.6L V8 281 CID	2002	Base, LX, Police Interceptor, S; Police, Pump Length: long	US4128
2.5L V6 2450cc 155 CID	1999	SVT	US4115	4.6L V8 281 CID	2002	Base, LX, Police Interceptor, S; Exc.Police, Short Housing	US4128
2.5L V6 2450cc 155 CID	2000	LX, SE, SVT	US4091	4.6L V8 281 CID	2003	Base, LX, Police Interceptor, S	US4128
2.5L V6 2450cc 155 CID	2000	LX, SE, SVT; Includes back housing	US4091-2	4.6L V8 281 CID	2004	Base, LX, LX Sport, Police Interceptor	US4128
<b>COUGAR</b>				4.6L V8 281 CID	2005	Base, LX, LX Sport, Police Interceptor, S, Special Edition	US4128
3.8L L6 3802cc 232 CID	1996	Mexican Application	US4103	4.6L V8 281 CID	2006	Base, LX, LX Sport, Police Interceptor	US4128
3.8L V6 3797cc 232 CID	1990-1994	Mexican Application	US4050	4.6L V8 281 CID	2007-2008	Base, LX, Police Interceptor	US4128
3.8L V6 3800cc 232 CID	1985-1987	Mexican Application	US4016	4.6L V8 281 CID	2009	LX, Police Interceptor	US4128
3.8L V6 3800cc 232 CID	1988-1989	Mexican Application	US4050	4.6L V8 281 CID	2010-2011	Base, LX, Police Interceptor	US4128
3.8L V6 3802cc 232 CID	1987	Mexican Application	US4016	<b>CUSTOM</b>			
3.8L V6 3802cc 232 CID	1988-1993	Mexican Application	US4050	4.7L V8 4727cc 289 CID	1965		US819
3.8L V6 3802cc 232 CID	1994-1995	Mexican Application	US4090	4.8L V8 4786cc 292 CID	1957		US488
4.9L V8 4900cc 299 CID	1994	Mexican Application	US4057	<b>CUSTOM 300</b>			
5.0L V8 5000cc 302 CID	1991-1993	Mexican Application	US4057	4.8L V8 4786cc 292 CID	1958-1960		US488
<b>COUNTRY SEDAN</b>				<b>CUSTOM 500</b>			
2.4L L6 2360cc 144 CID	1960-1961		US1044	4.3L V8 260 CID	1964		US819
2.8L L6 2786cc 170 CID	1960-1961		US1044	4.7L V8 289 CID	1964-1967		US819
2.8L L6 2786cc 170 CID	1965-1969		US1044	5.8L V8 351 CID	1975-1977	MODIFIED	US932
3.3L L6 3277cc 200 CID	1965-1970		US1044	5.8L V8 351 CID	1975-1977	High performance	US953H
3.6L V8 3622cc 221 CID	1962-1963		US819	5.8L V8 351 CID	1976-1977	WINDSOR	US953
4.3L V8 4261cc 260 CID	1962-1965		US819	5.8L V8 352 CID	1964		US723
4.7L V8 4727cc 289 CID	1963-1967		US819	6.4L V8 390 CID	1964		US723
5.8L V8 5769cc 352 CID	1961-1964		US723	6.6L V8 400 CID	1975-1977	MODIFIED	US932
6.4L V8 6391cc 390 CID	1961-1964		US723	7.5L V8 460 CID	1975-1976		US1114
6.6L V8 6654cc 406 CID	1962-1963		US723	<b>CUSTOMLINE</b>			
7.0L V8 6997cc 427 CID	1963-1964		US723	3.9L V8 3917cc 239 CID	1954		US488
<b>COUNTRY SQUIRE</b>				4.4L V8 4458cc 272 CID	1955-1956		US488
2.4L L6 2360cc 144 CID	1960-1961		US1044	<b>E-100 ECONOLINE</b>			
2.8L L6 2786cc 170 CID	1960-1961		US1044	2.8L L6 170 CID	1969-1971		US1044
2.8L L6 2786cc 170 CID	1965-1969		US1044	2.8L L6 2786cc 170 CID	1969-1971		US1044
3.3L L6 3277cc 200 CID	1965-1970		US1044	4.9L L6 4917cc 300 CID	1975-1979		US4030N
3.6L V8 3622cc 221 CID	1962-1963		US819	4.9L L6 4917cc 300 CID	1980-1982	Base, Chateau, Custom	US4030N
4.3L V8 4261cc 260 CID	1962-1965		US819	4.9L L6 4917cc 300 CID	1983	Custom, XL	US4020
4.7L V8 4727cc 289 CID	1963-1965		US819	5.0L V8 302 CID	1974		US1052
5.0L V8 302 CID	1987	Base, LX	US4014	5.0L V8 302 CID	1975	WINDSOR	US953
5.0L V8 302 CID	1987	Base, LX; High performance	US4014H	5.0L V8 302 CID	1975	High performance	US953H
5.0L V8 302 CID	1988	Base, LX; To 06/1988	US4014	5.0L V8 302 CID	1979	WINDSOR	US953
5.0L V8 302 CID	1988	Base, LX; High performance, To 06/88	US4014H	5.0L V8 302 CID	1979	High performance	US953H
5.0L V8 302 CID	1988	Base, LX; From 06/1988	US4052	5.0L V8 302 CID	1980-1982	Base, Chateau, Custom; WINDSOR	US953
5.0L V8 302 CID	1988	Base, LX; From 06/88, High performance	US4052H	5.0L V8 302 CID	1980-1982	Base, Chateau, Custom; High performance	US953H
5.0L V8 302 CID	1989-1991	Base, LX	US4052	<b>COURIER</b>			
5.0L V8 302 CID	1989-1991	Base, LX; High performance	US4052H	1.6L L4 1598cc 98 CID	2001-2002		US8931
5.8L V8 5769cc 352 CID	1961-1964		US723	1.6L L4 1598cc 98 CID	2008-2009		US8931
6.4L V8 6391cc 390 CID	1961-1964		US723				
6.6L V8 6654cc 406 CID	1962-1963		US723				
7.0L V8 6997cc 427 CID	1963-1964		US723				

Engine	Years	Application Description	USMW	Engine	Years	Application Description	USMW
<b>FORD (cont'd.)</b>				<b>FORD (cont'd.)</b>			
<b>E-100 ECONOLINE (cont'd.)</b>				<b>E-150 ECONOLINE (cont'd.)</b>			
5.0L V8 302 CID	1983	Custom, XL; WINDSOR	US953	5.8L V8 351 CID	1988-1991	Custom, XL; High performance	US4044H
5.0L V8 302 CID	1983	Custom, XL; High performance	US953H	5.8L V8 351 CID	1992-1996	Base, XL	US4044
5.8L V8 351 CID	1975-1979	WINDSOR	US953	5.8L V8 351 CID	1992-1996	Base, XL; High performance	US4044H
5.8L V8 351 CID	1975-1979	High performance	US953H	<b>E-150 ECONOLINE CLUB WAGON</b>			
5.8L V8 351 CID	1980-1982	Base, Chateau, Custom; MODIFIED	US932	4.2L V6 256 CID	1997-2000	Chateau, Custom, XLT	US4105
5.8L V8 351 CID	1980-1982	Base, Chateau, Custom; WINDSOR	US953	4.2L V6 256 CID	2001-2002	Chateau, XL, XLT	US4105
5.8L V8 351 CID	1980-1982	Base, Chateau, Custom; High performance	US953H	4.6L V8 281 CID	1997-2000	Chateau, Custom, XLT	US8920
5.8L V8 351 CID	1983	Custom, XL; WINDSOR	US953	4.6L V8 281 CID	2001-2002	Chateau, XL, XLT	US8920
5.8L V8 351 CID	1983	Custom, XL; High performance	US953H	4.9L L6 4917cc 300 CID	1975-1977	From Engine #080001	US4030N
<b>E-100 ECONOLINE CLUB WAGON</b>				4.9L L6 4917cc 300 CID	1975-1977	Before S/N 080001	US4033
4.9L L6 4917cc 300 CID	1975-1979		US4030N	4.9L L6 4917cc 300 CID	1978-1979		US4030N
4.9L L6 4917cc 300 CID	1980-1982	Base, Chateau, Custom	US4030N	4.9L L6 4917cc 300 CID	1980-1982	Base, Chateau, Custom	US4030N
4.9L L6 4917cc 300 CID	1983	Custom, XL	US4020	4.9L L6 4917cc 300 CID	1983	Custom, XL	US4020
5.0L V8 302 CID	1979	WINDSOR	US953	4.9L L6 4917cc 300 CID	1984-1986	Base, XL, XLT	US4020
5.0L V8 302 CID	1979	High performance	US953H	4.9L L6 4917cc 300 CID	1987-1991	Custom, XL, XLT	US4048
5.0L V8 302 CID	1980-1982	Base, Chateau, Custom; WINDSOR	US953	4.9L L6 4917cc 300 CID	1992	Chateau, Custom, XLT	US4079
5.0L V8 302 CID	1980-1982	Base, Chateau, Custom; High performance	US953H	4.9L L6 4917cc 300 CID	1993-1996	Chateau, Custom, XLT	US4099
5.0L V8 302 CID	1983	Custom, XL; WINDSOR	US953	5.0L V8 302 CID	1979	WINDSOR	US953
5.0L V8 302 CID	1983	Custom, XL; High performance	US953H	5.0L V8 302 CID	1979	High performance	US953H
5.8L V8 351 CID	1975-1979	WINDSOR	US953	5.0L V8 302 CID	1980-1982	Base, Chateau, Custom; WINDSOR	US953
5.8L V8 351 CID	1975-1979	High performance	US953H	5.0L V8 302 CID	1980-1982	Base, Chateau, Custom; High performance	US953H
5.8L V8 351 CID	1980-1982	Base, Chateau, Custom; MODIFIED	US932	5.0L V8 302 CID	1983	Custom, XL; WINDSOR	US953
5.8L V8 351 CID	1980-1982	Base, Chateau, Custom; WINDSOR	US953	5.0L V8 302 CID	1983	Custom, XL; High performance	US953H
5.8L V8 351 CID	1980-1982	Base, Chateau, Custom; High performance	US953H	5.0L V8 302 CID	1984-1986	Base, XL, XLT; WINDSOR	US953
5.8L V8 351 CID	1983	Custom, XL; WINDSOR	US953	5.0L V8 302 CID	1984-1986	Base, XL, XLT; High performance	US953H
5.8L V8 351 CID	1983	Custom, XL; High performance	US953H	5.0L V8 302 CID	1987-1991	Custom, XL, XLT	US4044
<b>E-150</b>				5.0L V8 302 CID	1987-1991	Custom, XL, XLT; High performance	US4044H
4.2L V6 256 CID	2003	Base	US4105	5.0L V8 302 CID	1992-1996	Chateau, Custom, XLT	US4044
4.6L V8 281 CID	2003-2005	Base	US8920	5.0L V8 302 CID	1992-1996	Chateau, Custom, XLT; High performance	US4044H
4.6L V8 281 CID	2006-2007	Base, Chateau, XL, XLT	US8920	5.4L V8 330 CID	1997-2000	Chateau, Custom, XLT	US8920
4.6L V8 281 CID	2008-2014	Base, XL, XLT	US8920	5.4L V8 330 CID	2001-2002	Chateau, XL, XLT	US8920
5.4L V8 330 CID	2003-2005	Base	US8920	5.8L V8 351 CID	1975-1979	WINDSOR	US953
5.4L V8 330 CID	2006-2007	Base, Chateau, XL, XLT	US8920	5.8L V8 351 CID	1975-1979	High performance	US953H
5.4L V8 330 CID	2008-2014	Base, XL, XLT	US8920	5.8L V8 351 CID	1980-1982	Base, Chateau, Custom; MODIFIED	US932
<b>E-150 CLUB WAGON</b>				5.8L V8 351 CID	1980-1982	Base, Chateau, Custom; WINDSOR	US953
4.2L V6 256 CID	2003	Chateau, XL, XLT	US4105	5.8L V8 351 CID	1980-1982	Base, Chateau, Custom; High performance	US953H
4.6L V8 281 CID	2003-2005	Chateau, XL, XLT	US8920	5.8L V8 351 CID	1983	Custom, XL; WINDSOR	US953
5.4L V8 330 CID	2003-2005	Chateau, XL, XLT	US8920	5.8L V8 351 CID	1983	Custom, XL; High performance	US953H
<b>E-150 ECONOLINE</b>				5.8L V8 351 CID	1984-1986	Base, XL, XLT; WINDSOR	US953
4.2L V6 256 CID	1997-2000	Base, XL	US4105	5.8L V8 351 CID	1984-1986	Base, XL, XLT; High performance	US953H
4.2L V6 256 CID	2001-2002	Base	US4105	5.8L V8 351 CID	1987	Custom, XL, XLT; WINDSOR	US953
4.6L V8 281 CID	1997-2000	Base, XL	US8920	5.8L V8 351 CID	1987	Custom, XL, XLT; High performance	US953H
4.6L V8 281 CID	2001-2002	Base	US8920	5.8L V8 351 CID	1988-1991	Custom, XL, XLT	US4044
4.9L L6 4917cc 300 CID	1975-1977	From Engine #080001	US4030N	5.8L V8 351 CID	1988-1991	Custom, XL, XLT; High performance	US4044H
4.9L L6 4917cc 300 CID	1975-1977	Before S/N 080001	US4033	5.8L V8 351 CID	1992-1996	Chateau, Custom, XLT	US4044
4.9L L6 4917cc 300 CID	1978-1979		US4030N	5.8L V8 351 CID	1992-1996	Chateau, Custom, XLT; High performance	US4044H
4.9L L6 4917cc 300 CID	1980-1982	Base, Chateau, Custom	US4030N	<b>E-200 ECONOLINE</b>			
4.9L L6 4917cc 300 CID	1983	Custom, XL	US4020	2.8L L6 170 CID	1969-1971		US1044
4.9L L6 4917cc 300 CID	1984-1986	Base, XL	US4020	<b>E-250</b>			
4.9L L6 4917cc 300 CID	1987-1991	Custom, XL	US4048	4.2L V6 256 CID	2003	Base	US4105
4.9L L6 4917cc 300 CID	1992	Base, XL	US4079	4.6L V8 281 CID	2003-2014	Base	US8920
4.9L L6 4917cc 300 CID	1993-1996	Base, XL	US4099	5.4L V8 330 CID	2003-2014	Base	US8920
5.0L V8 302 CID	1975	WINDSOR	US953	<b>E-250 ECONOLINE</b>			
5.0L V8 302 CID	1975	High performance	US953H	4.2L V6 256 CID	1997-2000	Base, XL	US4105
5.0L V8 302 CID	1979	WINDSOR	US953	4.2L V6 256 CID	2001-2002	Base	US4105
5.0L V8 302 CID	1979	High performance	US953H	4.9L L6 4917cc 300 CID	1975-1977	From Engine #080001	US4030N
5.0L V8 302 CID	1980-1982	Base, Chateau, Custom; WINDSOR	US953	4.9L L6 4917cc 300 CID	1975-1977	Before S/N 080001	US4033
5.0L V8 302 CID	1980-1982	Base, Chateau, Custom; High performance	US953H	4.9L L6 4917cc 300 CID	1978-1979		US4030N
5.0L V8 302 CID	1983	Custom, XL; WINDSOR	US953	4.9L L6 4917cc 300 CID	1980-1982	Base, Chateau, Custom	US4030N
5.0L V8 302 CID	1983	Custom, XL; High performance	US953H	4.9L L6 4917cc 300 CID	1983	Custom, XL	US4020
5.0L V8 302 CID	1984-1986	Base, XL; WINDSOR	US953	4.9L L6 4917cc 300 CID	1984	Base, XL; Single rear wheels	US4020
5.0L V8 302 CID	1984-1986	Base, XL; High performance	US953H	4.9L L6 4917cc 300 CID	1984	Base, XL; Dual rear wheels	US4083
5.0L V8 302 CID	1987-1991	Custom, XL	US4044	4.9L L6 4917cc 300 CID	1985-1986	Base, XL	US4020
5.0L V8 302 CID	1987-1991	Custom, XL; High performance	US4044H	4.9L L6 4917cc 300 CID	1987-1991	Custom, XL	US4048
5.0L V8 302 CID	1992-1996	Base, XL	US4044	4.9L L6 4917cc 300 CID	1992	Base, XL	US4079
5.0L V8 302 CID	1992-1996	Base, XL; High performance	US4044H	4.9L L6 4917cc 300 CID	1993-1996	Base, XL	US4099
5.4L V8 330 CID	1997-2000	Base, XL	US8920	5.0L V8 302 CID	1975	WINDSOR	US953
5.4L V8 330 CID	2001-2002	Base	US8920	5.0L V8 302 CID	1975	High performance	US953H
5.8L V8 351 CID	1975-1979	WINDSOR	US953	5.0L V8 302 CID	1979	WINDSOR	US953
5.8L V8 351 CID	1975-1979	High performance	US953H	5.0L V8 302 CID	1979	High performance	US953H
5.8L V8 351 CID	1980-1982	Base, Chateau, Custom; MODIFIED	US932	5.0L V8 302 CID	1980-1982	Base, Chateau, Custom; WINDSOR	US953
5.8L V8 351 CID	1980-1982	Base, Chateau, Custom; WINDSOR	US953	5.0L V8 302 CID	1980-1982	Base, Chateau, Custom; High performance	US953H
5.8L V8 351 CID	1980-1982	Base, Chateau, Custom; High performance	US953H	5.0L V8 302 CID	1983	Custom, XL; WINDSOR	US953
5.8L V8 351 CID	1983	Custom, XL; WINDSOR	US953	5.0L V8 302 CID	1983	Custom, XL; High performance	US953H
5.8L V8 351 CID	1983	Custom, XL; High performance	US953H	5.0L V8 302 CID	1984-1986	Base, XL; WINDSOR	US953
5.8L V8 351 CID	1984-1986	Base, XL; WINDSOR	US953	5.0L V8 302 CID	1984-1986	Base, XL; High performance	US953H
5.8L V8 351 CID	1984-1986	Base, XL; High performance	US953H	5.0L V8 302 CID	1987-1991	Custom, XL	US4044
5.8L V8 351 CID	1987	Custom, XL; WINDSOR	US953	5.0L V8 302 CID	1987-1991	Custom, XL; High performance	US4044H
5.8L V8 351 CID	1987	Custom, XL; High performance	US953H	5.4L V8 330 CID	1997-2000	Base, XL	US8920
5.8L V8 351 CID	1988-1991	Custom, XL	US4044	5.4L V8 330 CID	2001-2002	Base	US8920

WATER PUMPS



Engine	Years	Application Description	USMW	Engine	Years	Application Description	USMW
<b>FORD (cont'd.)</b>				<b>FORD (cont'd.)</b>			
<b>E-250 ECONOLINE (cont'd.)</b>				<b>E-350 ECONOLINE (cont'd.)</b>			
5.8L V8 351 CID	1975-1979	WINDSOR	US953	5.0L V8 302 CID	1979	WINDSOR	US953
5.8L V8 351 CID	1975-1979	High performance	US953H	5.0L V8 302 CID	1979	High performance	US953H
5.8L V8 351 CID	1980-1982	Base, Chateau, Custom; MODIFIED	US932	5.4L V8 330 CID	1997-1998	Base, XL	US8920
5.8L V8 351 CID	1980-1982	Base, Chateau, Custom; WINDSOR	US953	5.8L V8 351 CID	1975-1979	WINDSOR	US953
5.8L V8 351 CID	1980-1982	Base, Chateau, Custom; High performance	US953H	5.8L V8 351 CID	1975-1979	High performance	US953H
5.8L V8 351 CID	1983	Custom, XL; WINDSOR	US953	5.8L V8 351 CID	1980-1982	Base, Chateau, Custom; MODIFIED	US932
5.8L V8 351 CID	1983	Custom, XL; High performance	US953H	5.8L V8 351 CID	1980-1982	Base, Chateau, Custom; WINDSOR	US953
5.8L V8 351 CID	1984-1986	Base, XL; WINDSOR	US953	5.8L V8 351 CID	1980-1982	Base, Chateau, Custom; High performance	US953H
5.8L V8 351 CID	1984-1986	Base, XL; High performance	US953H	5.8L V8 351 CID	1983	Custom, XL; WINDSOR	US953
5.8L V8 351 CID	1987	Custom, XL; WINDSOR	US953	5.8L V8 351 CID	1983	Custom, XL; High performance	US953H
5.8L V8 351 CID	1987	Custom, XL; High performance	US953H	5.8L V8 351 CID	1984-1986	Base, XL; WINDSOR	US953
5.8L V8 351 CID	1988-1991	Custom, XL	US4044	5.8L V8 351 CID	1984-1986	Base, XL; High performance	US953H
5.8L V8 351 CID	1988-1991	Custom, XL; High performance	US4044H	5.8L V8 351 CID	1987	Custom, XL; WINDSOR	US953
5.8L V8 351 CID	1992-1996	Base, XL	US4044	5.8L V8 351 CID	1987	Custom, XL; High performance	US953H
5.8L V8 351 CID	1992-1996	Base, XL; High performance	US4044H	5.8L V8 351 CID	1988-1991	Custom, XL	US4044
6.6L V8 400 CID	1980	Base, Chateau, Custom; MODIFIED	US932	5.8L V8 351 CID	1988-1991	Custom, XL; High performance	US4044H
7.5L V8 460 CID	1975-1979		US1114	5.8L V8 351 CID	1992-1996	Base, XL	US4044
7.5L V8 460 CID	1980	Base, Chateau, Custom	US1114	5.8L V8 351 CID	1992-1996	Base, XL; High performance	US4044H
<b>E-250 ECONOLINE CLUB WAGON</b>				<b>E-350 ECONOLINE CLUB WAGON</b>			
4.9L L6 4917cc 300 CID	1977	From Engine #080001	US4030N	4.9L L6 4917cc 300 CID	1977	From Engine #080001	US4030N
4.9L L6 4917cc 300 CID	1977	Before S/N 080001	US4033	4.9L L6 4917cc 300 CID	1977	Before S/N 080001	US4033
4.9L L6 4917cc 300 CID	1978-1979		US4030N	4.9L L6 4917cc 300 CID	1978-1979		US4030N
4.9L L6 4917cc 300 CID	1980	Base, Chateau, Custom	US4030N	4.9L L6 4917cc 300 CID	1980-1982	Base, Chateau, Custom	US4030N
4.9L L6 4917cc 300 CID	1983	Custom, XL	US4020	4.9L L6 4917cc 300 CID	1983	Custom, XL	US4020
4.9L L6 4917cc 300 CID	1984	Base, XL, XLT; Single rear wheels	US4020	4.9L L6 4917cc 300 CID	1984	Base, XL, XLT; Single rear wheels	US4020
4.9L L6 4917cc 300 CID	1984	Base, XL, XLT; Dual rear wheels	US4083	4.9L L6 4917cc 300 CID	1984	Base, XL, XLT; Dual rear wheels	US4083
4.9L L6 4917cc 300 CID	1985-1986	Base, XL, XLT	US4020	4.9L L6 4917cc 300 CID	1985-1986	Base, XL, XLT	US4020
4.9L L6 4917cc 300 CID	1987	XL, XLT	US4048	4.9L L6 4917cc 300 CID	1987-1989	Custom, XL, XLT	US4048
4.9L L6 4917cc 300 CID	1988-1991	Custom, XL, XLT	US4048	4.9L L6 4917cc 300 CID	1990	Custom, XL	US4048
5.0L V8 302 CID	1979	WINDSOR	US953	4.9L L6 4917cc 300 CID	1991	Custom, XL, XLT	US4048
5.0L V8 302 CID	1979	High performance	US953H	4.9L L6 4917cc 300 CID	1992	Chateau, Chateau HD, Custom, Custom HD, XLT, XLT HD	US4079
5.0L V8 302 CID	1980	Base, Chateau, Custom; WINDSOR	US953	4.9L L6 4917cc 300 CID	1993	Chateau, Chateau HD, Custom, Custom HD, XLT, XLT HD	US4099
5.0L V8 302 CID	1980	Base, Chateau, Custom; High performance	US953H	4.9L L6 4917cc 300 CID	1994-1996	Chateau, Chateau HD, Custom, XL HD, XLT, XLT HD	US4099
5.8L V8 351 CID	1975-1979	WINDSOR	US953	5.0L V8 302 CID	1979	WINDSOR	US953
5.8L V8 351 CID	1975-1979	High performance	US953H	5.0L V8 302 CID	1979	High performance	US953H
5.8L V8 351 CID	1980-1982	Base, Chateau, Custom; MODIFIED	US932	5.4L V8 330 CID	1997-1998	Chateau, Custom, XL HD, XLT, XLT HD	US8920
5.8L V8 351 CID	1980-1982	Base, Chateau, Custom; WINDSOR	US953	5.4L V8 330 CID	1999-2000	Chateau, Custom, XLT	US8920
5.8L V8 351 CID	1980-1982	Base, Chateau, Custom; High performance	US953H	5.4L V8 330 CID	2001-2002	Chateau, XL, XLT	US8920
5.8L V8 351 CID	1980-1982	Custom, XL; WINDSOR	US953	5.8L V8 351 CID	1977-1979	WINDSOR	US953
5.8L V8 351 CID	1983	Custom, XL; High performance	US953H	5.8L V8 351 CID	1977-1979	High performance	US953H
5.8L V8 351 CID	1984-1986	Base, XL, XLT; WINDSOR	US953	5.8L V8 351 CID	1980-1982	Base, Chateau, Custom; MODIFIED	US932
5.8L V8 351 CID	1984-1986	Base, XL, XLT; High performance	US953H	5.8L V8 351 CID	1980-1982	Base, Chateau, Custom; WINDSOR	US953
5.8L V8 351 CID	1987	Custom, XL, XLT; WINDSOR	US953	5.8L V8 351 CID	1980-1982	Base, Chateau, Custom; High performance	US953H
5.8L V8 351 CID	1987	Custom, XL, XLT; High performance	US953H	5.8L V8 351 CID	1983	Custom, XL; WINDSOR	US953
5.8L V8 351 CID	1988-1991	Custom, XL, XLT	US4044	5.8L V8 351 CID	1984-1986	Base, XL, XLT; High performance	US953H
5.8L V8 351 CID	1988-1991	Custom, XL, XLT; High performance	US4044H	5.8L V8 351 CID	1987	Custom, XL, XLT; WINDSOR	US953
6.6L V8 400 CID	1980-1982	Base, Chateau, Custom; MODIFIED	US932	5.8L V8 351 CID	1987	Custom, XL, XLT; High performance	US953H
6.9L V8 420 CID	1983	Custom, XL	US4018	5.8L V8 351 CID	1988-1989	Custom, XL, XLT	US4044
6.9L V8 420 CID	1984-1986	Base, XL, XLT	US4018	5.8L V8 351 CID	1988-1989	Custom, XL, XLT; High performance	US4044H
6.9L V8 420 CID	1987	Custom, XL, XLT	US4018	5.8L V8 351 CID	1990	Custom, XL	US4044
7.3L V8 445 CID	1988-1991	Custom, XL, XLT	US4018	5.8L V8 351 CID	1990	Custom, XL; High performance	US4044H
7.5L V8 460 CID	1975-1979		US1114	5.8L V8 351 CID	1991	Custom, XL, XLT	US4044
7.5L V8 460 CID	1980-1982	Base, Chateau, Custom	US1114	5.8L V8 351 CID	1991	Custom, XL, XLT; High performance	US4044H
7.5L V8 460 CID	1983	Custom, XL	US1114	5.8L V8 351 CID	1992-1993	Chateau, Chateau HD, Custom, Custom HD, XLT, XLT HD	US4044
7.5L V8 460 CID	1984-1986	Base, XL, XLT	US1114				
7.5L V8 460 CID	1987	Custom, XL, XLT	US1114				
7.5L V8 460 CID	1988-1989	Custom, XL, XLT	US4081				
7.5L V8 460 CID	1990-1991	Custom, XL, XLT	US1114				
<b>E-300 ECONOLINE</b>				<b>E-350 ECONOLINE</b>			
2.8L L6 170 CID	1969-1970		US1044	4.9L L6 4917cc 300 CID	1975-1977	From Engine #080001	US4030N
5.0L V8 302 CID	1974		US1052	4.9L L6 4917cc 300 CID	1975-1977	Before S/N 080001	US4033
<b>E-350 CLUB WAGON</b>				<b>E-350 ECONOLINE</b>			
5.4L V8 330 CID	2003-2005	Chateau, XL, XLT	US8920	4.9L L6 4917cc 300 CID	1978-1979		US4030N
6.0L V8 363 CID	2004-2005	Chateau, XL, XLT	US67	4.9L L6 4917cc 300 CID	1980-1982	Base, Chateau, Custom	US4030N
6.8L V10 415 CID	2003	Chateau, XL, XLT	US4109	4.9L L6 4917cc 300 CID	1983	Custom, XL	US4020
6.8L V10 415 CID	2005	Chateau, XL, XLT	US4109	4.9L L6 4917cc 300 CID	1984	Base, XL, XLT; Single rear wheels	US4020
7.3L V8 445 CID	2003	Chateau, XL, XLT	US4114	4.9L L6 4917cc 300 CID	1984	Base, XL, XLT; Dual rear wheels	US4083
<b>E-350 ECONOLINE</b>				<b>E-350 ECONOLINE</b>			
4.9L L6 4917cc 300 CID	1975-1977	From Engine #080001	US4030N	4.9L L6 4917cc 300 CID	1985-1986	Base, XL, XLT	US4020
4.9L L6 4917cc 300 CID	1975-1977	Before S/N 080001	US4033	4.9L L6 4917cc 300 CID	1987-1989	Custom, XL, XLT	US4048
4.9L L6 4917cc 300 CID	1978-1979		US4030N	4.9L L6 4917cc 300 CID	1990	Custom, XL	US4048
4.9L L6 4917cc 300 CID	1980-1982	Base, Chateau, Custom	US4030N	4.9L L6 4917cc 300 CID	1991	Custom, XL, XLT	US4048
4.9L L6 4917cc 300 CID	1983	Custom, XL	US4020	4.9L L6 4917cc 300 CID	1992	Chateau, Chateau HD, Custom, Custom HD, XLT, XLT HD	US4079
4.9L L6 4917cc 300 CID	1984	Base, XL; Single rear wheels	US4020	4.9L L6 4917cc 300 CID	1993	Chateau, Chateau HD, Custom, Custom HD, XLT, XLT HD	US4099
4.9L L6 4917cc 300 CID	1984	Base, XL; Dual rear wheels	US4083	4.9L L6 4917cc 300 CID	1994-1996	Chateau, Chateau HD, Custom, XL HD, XLT, XLT HD	US4099
4.9L L6 4917cc 300 CID	1985-1986	Base, XL	US4020	5.0L V8 302 CID	1979	WINDSOR	US953
4.9L L6 4917cc 300 CID	1987-1991	Custom, XL	US4048	5.0L V8 302 CID	1979	High performance	US953H
4.9L L6 4917cc 300 CID	1992	Base, XL	US4079	5.4L V8 330 CID	1997-1998	Chateau, Custom, XL HD, XLT, XLT HD	US8920
4.9L L6 4917cc 300 CID	1993-1996	Base, XL	US4099	5.4L V8 330 CID	1999-2000	Chateau, Custom, XLT	US8920
5.0L V8 302 CID	1975	WINDSOR	US953	5.4L V8 330 CID	2001-2002	Chateau, XL, XLT	US8920
5.0L V8 302 CID	1975	High performance	US953H	5.8L V8 351 CID	1977-1979	WINDSOR	US953
				5.8L V8 351 CID	1977-1979	High performance	US953H
				5.8L V8 351 CID	1980-1982	Base, Chateau, Custom; MODIFIED	US932
				5.8L V8 351 CID	1980-1982	Base, Chateau, Custom; WINDSOR	US953
				5.8L V8 351 CID	1980-1982	Base, Chateau, Custom; High performance	US953H
				5.8L V8 351 CID	1983	Custom, XL; WINDSOR	US953
				5.8L V8 351 CID	1983	Custom, XL; High performance	US953H
				5.8L V8 351 CID	1984-1986	Base, XL, XLT; WINDSOR	US953
				5.8L V8 351 CID	1984-1986	Base, XL, XLT; High performance	US953H
				5.8L V8 351 CID	1987	Custom, XL, XLT; WINDSOR	US953
				5.8L V8 351 CID	1987	Custom, XL, XLT; High performance	US953H
				5.8L V8 351 CID	1988-1989	Custom, XL, XLT	US4044
				5.8L V8 351 CID	1988-1989	Custom, XL, XLT; High performance	US4044H
				5.8L V8 351 CID	1990	Custom, XL	US4044
				5.8L V8 351 CID	1990	Custom, XL; High performance	US4044H
				5.8L V8 351 CID	1991	Custom, XL, XLT	US4044
				5.8L V8 351 CID	1991	Custom, XL, XLT; High performance	US4044H
				5.8L V8 351 CID	1992-1993	Chateau, Chateau HD, Custom, Custom HD, XLT, XLT HD	US4044



Engine	Years	Application Description	USMW	Engine	Years	Application Description	USMW
<b>FORD (cont'd.)</b>				<b>FORD (cont'd.)</b>			
<b>E-350 ECONOLINE CLUB WAGON (cont'd.)</b>				<b>E-450 SUPER DUTY (cont'd.)</b>			
5.8L V8 351 CID	1992-1993	Chateau, Chateau HD, Custom, Custom HD, XLT, XLT HD; High performance	US4044H	7.3L V8 445 CID	2003	Custom, Medium/Heavy Duty	US4114
5.8L V8 351 CID	1994-1996	Chateau, Chateau HD, Custom, XL HD, XLT, XLT HD	US4044	<b>E-550 ECONOLINE SUPER DUTY</b>			
5.8L V8 351 CID	1994-1996	Chateau, Chateau HD, Custom, XL HD, XLT, XLT HD; High performance	US4044H	6.8L V10 415 CID	2002	Custom, Medium/Heavy Duty	US4109
6.6L V8 400 CID	1980-1982	Base, Chateau, Custom; MODIFIED	US932	7.3L V8 445 CID	2002	Custom, Medium/Heavy Duty	US4114
6.8L V10 415 CID	1997-1998	Chateau, Custom, XL HD, XLT, XLT HD	US4109	<b>E-550 SUPER DUTY</b>			
6.8L V10 415 CID	1999-2000	Chateau, Custom, XLT	US4109	6.8L V10 415 CID	2003	Custom, Medium/Heavy Duty	US4109
6.8L V10 415 CID	2001-2002	Chateau, XL, XLT	US4109	7.3L V8 445 CID	2003	Custom, Medium/Heavy Duty	US4114
6.9L V8 420 CID	1983	Custom, XL	US4018	<b>ECONOLINE</b>			
6.9L V8 420 CID	1984-1986	Base, XL, XLT	US4018	2.4L L6 144 CID	1961-1965		US1044
6.9L V8 420 CID	1987	Custom, XL, XLT	US4018	2.8L L6 170 CID	1962-1966		US1044
7.3L V8 445 CID	1988-1989	Custom, XL, XLT	US4018	<b>ECONOLINE SUPER DUTY</b>			
7.3L V8 445 CID	1990	Custom, XL	US4018	5.8L V8 351 CID	1996	Custom, Medium/Heavy Duty	US4044
7.3L V8 445 CID	1991	Custom, XL, XLT	US4018	5.8L V8 351 CID	1996	Custom, High performance, Medium/Heavy Duty	US4044H
7.3L V8 445 CID	1992-1993	Chateau, Chateau HD, Custom, Custom HD, XLT, XLT HD	US4018	6.8L V10 415 CID	1997-1999	Custom, Medium/Heavy Duty	US4109
7.3L V8 445 CID	1994	Chateau, Chateau HD, Custom, XL HD, XLT, XLT HD	US4018	6.8L V10 415 CID	1999	Base, Medium/Heavy Duty	US4109
7.3L V8 445 CID	1995	Chateau, Chateau HD, Custom, XL HD, XLT, XLT HD	US4096	7.3L V8 445 CID	1996	Custom, Medium/Heavy Duty, To Engine # 201680	US4096
7.3L V8 445 CID	1996	Chateau, Chateau HD, Custom, XL HD, XLT, XLT HD; To Engine # 201680	US4096	7.3L V8 445 CID	1996	Custom, From Engine # 201681, Medium/Heavy Duty	US4114
7.3L V8 445 CID	1996	Chateau, Chateau HD, Custom, XL HD, XLT, XLT HD; From Engine # 201681	US4114	7.3L V8 445 CID	1997	Custom, Medium/Heavy Duty	US4114
7.3L V8 445 CID	1997	Chateau, Custom, XL HD, XLT, XLT HD	US4114	7.3L V8 445 CID	1998	Custom, From 01/12/1998, Medium/Heavy Duty	US4114
7.3L V8 445 CID	1998	Chateau, Custom, XL HD, XLT, XLT HD; From 01/12/1998	US4114	7.3L V8 445 CID	1998	Custom, Medium/Heavy Duty, To 01/12/1998	US4114
7.3L V8 445 CID	1999-2000	Chateau, Custom, XLT	US4114	7.3L V8 445 CID	1999	Base, Medium/Heavy Duty	US4114
7.3L V8 445 CID	2001-2002	Chateau, XL, XLT	US4114	7.3L V8 445 CID	1999	Custom, Medium/Heavy Duty	US4114
7.5L V8 460 CID	1977-1979		US1114	7.5L V8 460 CID	1996	Custom, Medium/Heavy Duty	US4086
7.5L V8 460 CID	1980-1982	Base, Chateau, Custom	US1114	<b>ECONOLINE WAGON</b>			
7.5L V8 460 CID	1983	Custom, XL	US1114	4.2L V6 4195cc 256 CID	1999-2002	Mexican Application	US4105
7.5L V8 460 CID	1984-1986	Base, XL, XLT	US1114	5.0L V8 5000cc 305 CID	1999-2002	Mexican Application	US4044
7.5L V8 460 CID	1987	Custom, XL, XLT	US1114	<b>ECOSPORT</b>			
7.5L V8 460 CID	1988-1989	Custom, XL, XLT	US4081	1.0L L3 999cc 61 CID	2018	S, SE, Titanium	US8146
7.5L V8 460 CID	1990	Custom, XL	US1114	2.0L L4 1984cc 121 CID	2004	Mexican Application	US4115
7.5L V8 460 CID	1991	Custom, XL, XLT	US1114	2.0L L4 1999cc 122 CID	2005-2011		US4126
7.5L V8 460 CID	1992	Chateau, Chateau HD, Custom, Custom HD, XLT, XLT HD; To 02/03/1992	US1114	2.0L L4 1999cc 122 CID	2018	S, SE, SES, Titanium	US4126
7.5L V8 460 CID	1992	Chateau, Chateau HD, Custom, Custom HD, XLT, XLT HD; From 02/03/1992	US4077	<b>EDGE</b>			
7.5L V8 460 CID	1993	Chateau, Chateau HD, Custom, Custom HD, XLT, XLT HD	US4077	2.0L L4 1999cc 122 CID	2012-2014	Limited, SE, SEL	US4126
7.5L V8 460 CID	1994	Chateau, Chateau HD, Custom, XL HD, XLT, XLT HD	US4077	2.0L L4 1999cc 122 CID	2015	SE, SEL, Titanium	US4126
7.5L V8 460 CID	1995-1996	Chateau, Chateau HD, Custom, XL HD, XLT, XLT HD	US4086	2.0L L4 1999cc 122 CID	2015	SE, SEL, Titanium; To 04/27/2015	US8117
<b>E-350 SUPER DUTY</b>				2.0L L4 1999cc 122 CID	2015	SE, SEL, Titanium; From 04/27/2015	US8975
5.4L V8 330 CID	1999-2000	Base, XL	US8920	2.0L L4 1999cc 122 CID	2016-2018	SE, SEL, Titanium	US8975
5.4L V8 330 CID	2001-2005	Base	US8920	2.7L V6 164 CID	2016	Sport	US8141P
5.4L V8 330 CID	2006-2014	Base, XL, XLT	US8920	2.7L V6 164 CID	2016	Sport; Includes 3 hole pulley	US8141P-T
5.4L V8 330 CID	2015-2016	Base	US8920	2.7L V6 164 CID	2016	Sport; Includes 3 hole pulley and thermostat / housing	US8141P-T
6.0L V8 363 CID	2004-2005	Base	US67	2.7L V6 164 CID	2016-2017	Sport; 3 Bolt hub Includes thermostat / housing	US8141-T
6.0L V8 363 CID	2006-2008	Base, XL, XLT	US67	2.7L V6 164 CID	2016-2017	Sport	US8141
6.0L V8 363 CID	2009	Base, XLT	US67	2.7L V6 164 CID	2016-2018	Sport	US8141
6.0L V8 363 CID	2010	Base, XL, XLT	US67	3.5L V6 3496cc 213 CID	2007	SE, SEL	US6023
6.2L V8 6210cc 379 CID	2017-2018	Base	US6006	3.5L V6 3496cc 213 CID	2008	Limited, SE, SEL	US6023
6.8L V10 415 CID	1999-2000	Base, XL	US4109	3.5L V6 3496cc 213 CID	2009-2010	Limited, SE, SEL, Sport	US6023
6.8L V10 415 CID	2001-2005	Base	US4109	3.5L V6 3496cc 213 CID	2011	Limited, SE, SEL	US8980
6.8L V10 415 CID	2006-2007	Base, XL, XLT	US4109	3.5L V6 3496cc 213 CID	2012	Limited, SE, SEL; From 01/02/2012	US8910
6.8L V10 415 CID	2008	Base	US4109	3.5L V6 3496cc 213 CID	2012	Limited, SE, SEL; To 01/02/2012	US8980
6.8L V10 415 CID	2009	Base, XL	US4109	3.5L V6 3496cc 213 CID	2013-2014	Limited, SE, SEL	US8910
6.8L V10 415 CID	2010-2014	Base, XL, XLT	US6144	3.5L V6 3496cc 213 CID	2015-2016	SE, SEL, Titanium	US8910
6.8L V10 415 CID	2015	Base	US6144	3.5L V6 3496cc 213 CID	2017	SEL, Titanium	US8910
6.8L V10 415 CID	2016-2018	Base	US4109	3.5L V6 3496cc 213 CID	2018	SE, SEL, Titanium	US8910
7.3L V8 445 CID	1999-2000	Base, XL	US4114	3.7L V6 3726cc 227 CID	2011	Sport	US8980
7.3L V8 445 CID	2001-2003	Base	US4114	3.7L V6 3726cc 227 CID	2012	Sport; From 01/02/2012	US8910
<b>E-450 ECONOLINE SUPER DUTY</b>				3.7L V6 3726cc 227 CID	2012	Sport; To 01/02/2012	US8980
6.8L V10 415 CID	2000-2002	Custom, Medium/Heavy Duty	US4109	3.7L V6 3726cc 227 CID	2013-2014	Sport	US8910
7.3L V8 445 CID	2000-2002	Custom, Medium/Heavy Duty	US4114	<b>ELITE</b>			
<b>E-450 SUPER DUTY</b>				5.8L V8 351 CID	1975	WINDSOR	US953
5.4L V8 330 CID	2014-2016	Base	US8920	5.8L V8 351 CID	1975-1976	MODIFIED	US932
6.8L V10 415 CID	2003	Custom, Medium/Heavy Duty	US4109	5.8L V8 351 CID	1975-1976	High performance	US953H
6.8L V10 415 CID	2004-2009	Base, Medium/Heavy Duty	US4109	6.6L V8 400 CID	1975-1976	MODIFIED	US932
6.8L V10 415 CID	2010-2015	Base, Medium/Heavy Duty	US6144	7.5L V8 460 CID	1975-1976		US1114
6.8L V10 415 CID	2014-2015	Base	US6144	<b>ESCAPE</b>			
6.8L V10 415 CID	2016-2017	Base	US4109	1.5L L4 1499cc 91 CID	2017	SE, Titanium	US8107
6.8L V10 415 CID	2016-2017	Base	US4109	1.5L L4 1499cc 91 CID	2018	SE, SEL	US8107
6.8L V10 415 CID	2016-2017	Base	US4109	1.6L L4 1601cc 98 CID	2013	SE, SEL	US9449
6.8L V10 415 CID	2016-2017	Base	US4109	1.6L L4 1601cc 98 CID	2014-2016	SE, Titanium	US9449
6.8L V10 415 CID	2016-2017	Base	US4109	2.0L L4 1989cc 121 CID	2001-2003	XLS, XLT	US4115
6.8L V10 415 CID	2016-2017	Base	US4109	2.0L L4 1989cc 121 CID	2004	Limited, XLS, XLT	US4115
6.8L V10 415 CID	2016-2017	Base	US4109	2.0L L4 1999cc 122 CID	2013	SE, SEL, Titanium	US4126
6.8L V10 415 CID	2016-2017	Base	US4109	2.0L L4 1999cc 122 CID	2014-2015	SE, Titanium	US4126
6.8L V10 415 CID	2016-2017	Base	US4109	2.0L L4 1999cc 122 CID	2016	SE, Titanium; To 11/19/2015	US4126
6.8L V10 415 CID	2016-2017	Base	US4109	2.0L L4 1999cc 122 CID	2016	SE, Titanium; From 11/19/2015	US8117
6.8L V10 415 CID	2016-2017	Base	US4109	2.0L L4 1999cc 122 CID	2017	SE, Titanium	US8975
6.8L V10 415 CID	2016-2017	Base	US4109				

WATER PUMPS

Engine	Years	Application Description	USMWW
<b>FORD (cont'd.)</b>			
<b>ESCAPE (cont'd.)</b>			
2.0L L4 1999cc 122 CID	2018	Titanium	<b>US8975</b>
2.3L L4 140 CID	2005	Hybrid, XLS, XLT, XLT No Boundaries	<b>US4126</b>
2.3L L4 140 CID	2005-2008	Hybrid; Electric Water Pump	<b>US11002</b>
2.3L L4 140 CID	2006-2008	Hybrid, XLS, XLT	<b>US4126</b>
2.5L L4 2488cc 152 CID	2009-2012	Hybrid, Limited, Limited Hybrid, XLS, XLT	<b>US4126</b>
2.5L L4 2488cc 152 CID	2009-2012	Hybrid, Limited Hybrid; Electric Water Pump, From Reservoir	<b>US11001</b>
2.5L L4 2488cc 152 CID	2009-2012	Hybrid, Limited Hybrid; Electric Water Pump, Heater	<b>US11007</b>
2.5L L4 2488cc 152 CID	2011	Hybrid, Limited Hybrid; Electric Water Pump	<b>US11002</b>
2.5L L4 2488cc 152 CID	2013-2014	S	<b>US4126</b>
2.5L L4 2488cc 152 CID	2015-2016	S, SE	<b>US4126</b>
2.5L L4 2488cc 152 CID	2017-2018	S	<b>US4126</b>
3.0L V6 2967cc 181 CID	2011-2012	Mexican Application	<b>US6250</b>
3.0L V6 2968cc 181 CID	2001-2002	XLS, XLT	<b>US4091</b>
3.0L V6 2968cc 181 CID	2001-2002	XLS, XLT; Includes back housing	<b>US4091-2</b>
3.0L V6 2968cc 181 CID	2003	Limited, XLS, XLT; To 04/01/2003	<b>US4091</b>
3.0L V6 2968cc 181 CID	2003	Limited, XLS, XLT; Includes back housing, To 04/01/2003	<b>US4091-2</b>
3.0L V6 2968cc 181 CID	2003	Limited, XLS, XLT; From 04/01/2003	<b>US4132</b>
3.0L V6 2968cc 181 CID	2003	Limited, XLS, XLT; From 04/01/2003, Includes back housing	<b>US4132-2</b>
3.0L V6 2968cc 181 CID	2004	Limited, XLS, XLT	<b>US4132</b>
3.0L V6 2968cc 181 CID	2004	Limited, XLS, XLT; Includes back housing	<b>US4132-2</b>
3.0L V6 2968cc 181 CID	2005	Limited, XLS, XLT, XLT No Boundaries, XLT Sport	<b>US4132</b>
3.0L V6 2968cc 181 CID	2005	Limited, XLS, XLT, XLT No Boundaries, XLT Sport; Includes back housing	<b>US4132-2</b>
3.0L V6 2968cc 181 CID	2006	Limited, XLT; To 01/30/2006	<b>US4132</b>
3.0L V6 2968cc 181 CID	2006	Limited, XLT; Includes back housing, To 01/30/2006	<b>US4132-2</b>
3.0L V6 2968cc 181 CID	2006	Limited, XLT; From 01/30/2006	<b>US9489</b>
3.0L V6 2968cc 181 CID	2006	Limited, XLT; From 01/30/2006, Includes back housing	<b>US9489-2</b>
3.0L V6 2968cc 181 CID	2007-2008	Limited, XLT	<b>US9489</b>
3.0L V6 2968cc 181 CID	2007-2008	Limited, XLT; Includes back housing	<b>US9489-2</b>
3.0L V6 2968cc 181 CID	2009-2012	Limited, XLT	<b>US6250</b>
<b>ESCORT</b>			
1.6L L4 1598cc 98 CID	1981	Base, GL, GLX, L, SS	<b>US4040</b>
1.6L L4 1598cc 98 CID	1982	Base, GL, GLX, GT, L	<b>US4040</b>
1.6L L4 1598cc 98 CID	1983	Base, GL, GLX, GT, LX	<b>US4040</b>
1.6L L4 1598cc 98 CID	1984	Base, GL, GT, GT Turbo, LX	<b>US4040</b>
1.6L L4 1598cc 98 CID	1985	Base, GL, GT, GT Turbo, L, LX	<b>US4040</b>
1.8L L4 112 CID	1991	GT	<b>US4068</b>
1.8L L4 112 CID	1992-1993	GT, LX-E	<b>US4068</b>
1.8L L4 112 CID	1994-1996	GT	<b>US4068</b>
1.9L L4 116 CID	1985	Base, GL, L	<b>US4040</b>
1.9L L4 116 CID	1986	GL, GT, L, LX, Pony	<b>US4040</b>
1.9L L4 116 CID	1987	GL, GT, Pony	<b>US4040</b>
1.9L L4 116 CID	1988	GL, GT, LX, Pony	<b>US4040</b>
1.9L L4 116 CID	1989	GT, LX, Pony	<b>US4040</b>
1.9L L4 116 CID	1990	Base, GT, LX, LX Sport, Pony	<b>US4040</b>
1.9L L4 116 CID	1991	Base, LX, LX Sport; To 04/91	<b>US4065</b>
1.9L L4 116 CID	1991	Base, LX, LX Sport; From 04/91	<b>US4069</b>
1.9L L4 116 CID	1992-1993	Base, LX, LX Sport	<b>US4069</b>
1.9L L4 116 CID	1994	Base, LX, LX Sport; From 06/1994	<b>US4069</b>
1.9L L4 116 CID	1994	Base, LX, LX Sport; To 05/1994	<b>US4069</b>
1.9L L4 116 CID	1995	Base, LX, LX Sport	<b>US4069</b>
1.9L L4 116 CID	1996	Base, LX	<b>US4069</b>
2.0L L4 1989cc 121 CID	1997	Base, LX, Sport	<b>US4107</b>
2.0L L4 1989cc 121 CID	1998	ZX2 Cool Coupe, ZX2 Hot Coupe	<b>US4115</b>
2.0L L4 1989cc 121 CID	1998-1999	LX, SE	<b>US4107</b>
2.0L L4 1989cc 121 CID	1999	ZX2 Cool Coupe, ZX2 Hot Coupe, ZX2 S/R	<b>US4115</b>
2.0L L4 1989cc 121 CID	2000	LX	<b>US4107</b>
2.0L L4 1989cc 121 CID	2000	ZX2, ZX2 S/R	<b>US4115</b>
2.0L L4 1989cc 121 CID	2001-2002	SE	<b>US4107</b>
2.0L L4 1989cc 121 CID	2001-2003	ZX2	<b>US4115</b>
2.0L L4 1989cc 122 CID	1984	Base, GL, LX	<b>US9067</b>
2.0L L4 1989cc 122 CID	1985	Base, GL, L	<b>US9067</b>
2.0L L4 1989cc 122 CID	1986	GL, L	<b>US9067</b>
2.0L L4 1989cc 122 CID	1987	GL	<b>US9067</b>
<b>EXCURSION</b>			
5.4L V8 330 CID	2000-2002	Limited, XLT	<b>US8920</b>
5.4L V8 330 CID	2003	Eddie Bauer, Limited, XLT	<b>US8920</b>
5.4L V8 330 CID	2004-2005	Eddie Bauer, Limited, XLS, XLT	<b>US8920</b>
6.0L V8 363 CID	2003	Eddie Bauer, Limited, XLT	<b>US61</b>
6.0L V8 363 CID	2004-2005	Eddie Bauer, Limited, XLS, XLT	<b>US61</b>
6.8L V10 415 CID	2000-2002	Limited, XLT	<b>US4109</b>
6.8L V10 415 CID	2003	Eddie Bauer, Limited, XLT	<b>US4109</b>
6.8L V10 415 CID	2004-2005	Eddie Bauer, Limited, XLS, XLT	<b>US4109</b>
7.3L V8 445 CID	2000-2002	Limited, XLT	<b>US4114</b>
7.3L V8 445 CID	2003	Eddie Bauer, Limited, XLT	<b>US4114</b>

Engine	Years	Application Description	USMWW
<b>FORD (cont'd.)</b>			
<b>EXP</b>			
1.6L L4 1598cc 98 CID	1982	Base	<b>US4040</b>
1.6L L4 1598cc 98 CID	1983	Base, GT, HO, Luxury	<b>US4040</b>
1.6L L4 1598cc 98 CID	1984-1985	Base, Luxury, Turbo	<b>US4040</b>
1.9L L4 116 CID	1986-1987	Luxury, Sport	<b>US4040</b>
1.9L L4 116 CID	1988	Base, Luxury, Sport	<b>US4040</b>
<b>EXPEDITION</b>			
3.5L V6 3496cc 213 CID	2015	EL King Ranch, EL Limited, EL Platinum, EL XL, EL XLT, King Ranch, Limited, Platinum, XL, XLT	<b>US8916</b>
3.5L V6 3496cc 213 CID	2015	EL King Ranch, EL Limited, EL Platinum, EL XL, EL XLT, King Ranch, Limited, Platinum, XL, XLT; Serpentine Belt Driven	<b>US8916</b>
3.5L V6 3496cc 213 CID	2016-2017	EL King Ranch, EL Limited, EL Platinum, EL SSV, EL XL, EL XLT, King Ranch, Limited, Platinum, SSV, XL, XLT	<b>US8916</b>
4.6L V8 281 CID	1997-2003	Eddie Bauer, XLT	<b>US8920</b>
4.6L V8 281 CID	2004	Eddie Bauer, NBX, XLS, XLT, XLT Sport	<b>US8920</b>
5.4L V8 330 CID	1997-2003	Eddie Bauer, XLT	<b>US8920</b>
5.4L V8 330 CID	2004	Eddie Bauer, NBX, XLS, XLT, XLT Sport	<b>US8920</b>
5.4L V8 330 CID	2005	Eddie Bauer, King Ranch, Limited, XLS, XLT	<b>US8920</b>
5.4L V8 330 CID	2006	Eddie Bauer, King Ranch, Limited, XLS, XLT, XLT Sport	<b>US8920</b>
5.4L V8 330 CID	2007	Eddie Bauer, EL Eddie Bauer, EL Limited, EL XLT, Limited, XLT	<b>US6144</b>
5.4L V8 330 CID	2008	Eddie Bauer, EL Eddie Bauer, EL King Ranch, EL Limited, EL XLT, Funkmaster Flex Edition, King Ranch, Limited, XLT	<b>US6144</b>
5.4L V8 330 CID	2009	Eddie Bauer, EL Eddie Bauer, EL King Ranch, EL Limited, EL XLT, King Ranch, Limited, Max Eddie Bauer, Max King Ranch, Max Limited, XLT	<b>US8920</b>
5.4L V8 330 CID	2010	Eddie Bauer, EL Eddie Bauer, EL King Ranch, EL Limited, EL XLT, King Ranch, Limited, XLT	<b>US8920</b>
5.4L V8 330 CID	2011-2014	EL King Ranch, EL Limited, EL XL, EL XLT, King Ranch, Limited, XL, XLT	<b>US8920</b>
5.4L V8 5408cc 330 CID	2014	King Ranch, Limited, XL	<b>US8920</b>
<b>EXPLORER</b>			
2.0L L4 1999cc 122 CID	2012-2015	Base, Limited, XLT	<b>US4126</b>
2.3L L4 2300cc 140 CID	2016-2018	Base, Limited, XLT	<b>US8975</b>
3.5L V6 3496cc 213 CID	2011	Base, Limited, XLT	<b>US8980</b>
3.5L V6 3496cc 213 CID	2012	Base, Limited, XLT; From 01/02/2012	<b>US8910</b>
3.5L V6 3496cc 213 CID	2012	Base, Limited, XLT; To 01/02/2012	<b>US8980</b>
3.5L V6 3496cc 213 CID	2013-2015	Base, Limited, Sport, XLT	<b>US8910</b>
3.5L V6 3496cc 213 CID	2016-2018	Base, Limited, Platinum, Sport, XLT	<b>US8910</b>
4.0L L6 4018cc 245 CID	1990	Mexican Application	<b>US4060</b>
4.0L V6 245 CID	1991-1992	Eddie Bauer, Sport, XL, XLT	<b>US4060</b>
4.0L V6 245 CID	1993-1994	Eddie Bauer, Limited, Sport, XL, XLT	<b>US4060</b>
4.0L V6 245 CID	1995	Eddie Bauer, Expedition, Limited, Sport, XL, XLT	<b>US4060</b>
4.0L V6 245 CID	1996	Eddie Bauer, Limited, Sport, XL, XLT	<b>US4060</b>
4.0L V6 245 CID	1997-1998	Sport, XL, XLT; (X)	<b>US4060</b>
4.0L V6 245 CID	1997-1998	Sport, XL, XLT; (E)	<b>US4108</b>
4.0L V6 245 CID	1997-2000	Eddie Bauer, Limited	<b>US4108</b>
4.0L V6 245 CID	1999	Sport, XL, XLS, XLT; (X)	<b>US4060</b>
4.0L V6 245 CID	1999	Sport, XL, XLS, XLT; (E)	<b>US4108</b>
4.0L V6 245 CID	2000	Postal, Sport, XL Fleet, XLS, XLT; (X)	<b>US4060</b>
4.0L V6 245 CID	2000	Postal, Sport, XL Fleet, XLS, XLT; (E)	<b>US4108</b>
4.0L V6 245 CID	2001	Eddie Bauer, Limited, Postal, XL Fleet, XLS, XLT	<b>US4108</b>
4.0L V6 245 CID	2002-2003	Eddie Bauer, Limited, Postal, XLS, XLT	<b>US4108</b>
4.0L V6 245 CID	2004	Eddie Bauer, Limited, NBX, XLS, XLS Sport, XLT, XLT Sport	<b>US4108</b>
4.0L V6 245 CID	2005	Eddie Bauer, Limited, XLS, XLS Sport, XLT, XLT Sport	<b>US4108</b>
4.0L V6 245 CID	2006	Eddie Bauer, Limited, XLS, XLT	<b>US4108</b>
4.0L V6 245 CID	2007-2010	Eddie Bauer, Limited, XLT	<b>US4108</b>
4.6L V8 281 CID	2002-2003	Eddie Bauer, Limited, XLT	<b>US8920</b>
4.6L V8 281 CID	2004	Eddie Bauer, Limited, NBX, XLT, XLT Sport	<b>US8920</b>
4.6L V8 281 CID	2005	Eddie Bauer, Limited, XLT, XLT Sport	<b>US8920</b>
4.6L V8 281 CID	2006-2009	Eddie Bauer, Limited, XLT	<b>US8920</b>
4.6L V8 281 CID	2010	Eddie Bauer, Limited	<b>US8920</b>
5.0L V8 302 CID	1996-1998	Eddie Bauer, Limited, XLT	<b>US4101</b>
5.0L V8 302 CID	1999	Eddie Bauer, Limited, XLS, XLT	<b>US4101</b>
5.0L V8 302 CID	2000-2001	Eddie Bauer, Limited, XLT	<b>US4101</b>
<b>EXPLORER SPORT TRAC</b>			
4.0L V6 245 CID	2001	Base	<b>US4108</b>
4.0L V6 245 CID	2002	XL	<b>US4108</b>
4.0L V6 245 CID	2003-2004	XLS, XLT	<b>US4108</b>
4.0L V6 245 CID	2005	Adrenalin, XLS, XLT	<b>US4108</b>
4.0L V6 245 CID	2007-2010	Limited, XLT	<b>US4108</b>
4.6L V8 281 CID	2007-2010	Limited, XLT	<b>US8920</b>

Engine	Years	Application Description	USMW	Engine	Years	Application Description	USMW
<b>FORD (cont'd.)</b>				<b>FORD (cont'd.)</b>			
<b>F53</b>				<b>F800 LPO</b>			
6.8L V10 415 CID	2011-2014	Base, Medium/Heavy Duty	US6144	5.9L L6 359 CID	1995-1998		US7145N
6.8L V10 415 CID	2014	Base	US6144	<b>F-100</b>			
6.8L V10 415 CID	2015	Base, Medium/Heavy Duty	US4109	3.8L V6 232 CID	1982	Custom, XL, XLS, XLT Lariat	US4016
6.8L V10 415 CID	2015-2018	Base	US4109	3.8L V6 232 CID	1983	Base, XL, XLS, XLT Lariat	US4016
<b>F59</b>				4.2L V8 255 CID	1981	Custom, Ranger, Ranger Lariat, Ranger XLT; WINDSOR	US953
6.8L V10 415 CID	2014	Base	US6144	4.2L V8 255 CID	1981	Custom, Ranger, Ranger Lariat, Ranger XLT; High performance	US953H
6.8L V10 415 CID	2015-2018	Base	US4109	4.2L V8 255 CID	1982	Custom, XL, XLS, XLT Lariat; WINDSOR	US953
7.3L V8 445 CID	1993-1994	Medium/Heavy Duty, Naturally Aspirated, XL	US4018	4.2L V8 255 CID	1982	Custom, XL, XLS, XLT Lariat; High performance	US953H
7.3L V8 445 CID	1993-1994	Medium/Heavy Duty, Turbocharged, XL	US4018	4.4L V8 4458cc 272 CID	1956-1958		US488
7.3L V8 445 CID	1994	Medium/Heavy Duty, Turbocharged, XL	US4096	4.8L V8 4786cc 292 CID	1958-1963		US488
7.3L V8 445 CID	1995-1997	Base, Medium/Heavy Duty, Naturally Aspirated	US4018	4.9L L6 4917cc 300 CID	1975-1979		US4030N
<b>F100</b>				4.9L L6 4917cc 300 CID	1980-1981	Custom, Ranger, Ranger Lariat, Ranger XLT	US4030N
4.7L V8 4700cc 289 CID	1965-1966	Mexican Application	US819	4.9L L6 4917cc 300 CID	1982	Custom, XL, XLS, XLT Lariat	US4030N
4.7L V8 4700cc 289 CID	1965-1978	Mexican Application	US1028	4.9L L6 4917cc 300 CID	1983	Base, XL, XLS, XLT Lariat	US4020
4.7L V8 4700cc 289 CID	1969-1978	Mexican Application	US953	5.0L V8 302 CID	1975-1979	WINDSOR	US953
<b>F150</b>				5.0L V8 302 CID	1975-1979	High performance	US953H
3.8L V6 3800cc 232 CID	1984-1990	Mexican Application	US4016	5.0L V8 302 CID	1980-1981	Custom, Ranger, Ranger Lariat, Ranger XLT; WINDSOR	US953
3.8L V6 3800cc 232 CID	1991-1993	Mexican Application	US4051	5.0L V8 302 CID	1980-1981	Custom, Ranger, Ranger Lariat, Ranger XLT; High performance	US953H
3.8L V6 3800cc 232 CID	1994-1995	Mexican Application	US4089	5.0L V8 302 CID	1982	Custom, XL, XLS, XLT Lariat; WINDSOR	US953
4.7L V8 4700cc 289 CID	1979	Mexican Application	US953	5.0L V8 302 CID	1982	Custom, XL, XLS, XLT Lariat; High performance	US953H
4.9L L6 4900cc 300 CID	1997	Mexican Application	US4099	5.0L V8 302 CID	1983	Base, XL, XLS, XLT Lariat; WINDSOR	US953
5.0L V8 5000cc 302 CID	1986	Mexican Application	US953	5.0L V8 302 CID	1983	Base, XL, XLS, XLT Lariat; High performance	US953H
5.0L V8 5000cc 302 CID	1986-1990	Mexican Application	US4044	5.8L V8 351 CID	1977-1979	MODIFIED	US932
<b>F200</b>				5.8L V8 351 CID	1977-1979	WINDSOR	US953
5.0L V8 5000cc 302 CID	1986-1990	Mexican Application	US4044	5.8L V8 351 CID	1977-1979	High performance	US953H
5.8L V8 5800cc 351 CID	1986-1987	Mexican Application	US953	5.9L V8 360 CID	1975-1976	High performance	US1075
5.8L V8 5800cc 351 CID	1986-1990	Mexican Application	US4044	5.9L V8 360 CID	1975-1976	High performance	US1075H
<b>F250</b>				6.4L V8 390 CID	1975-1976	High performance	US1075
5.0L V8 5000cc 302 CID	1997	Mexican Application	US4044	6.4L V8 390 CID	1975-1976	High performance	US1075H
<b>F350</b>				6.6L V8 400 CID	1977-1979	MODIFIED	US932
4.7L V8 4700cc 289 CID	1965-1966	Mexican Application	US819	7.5L V8 460 CID	1979		US1114
4.7L V8 4700cc 289 CID	1965-1974	Mexican Application	US1028	<b>F-150</b>			
4.7L V8 4700cc 289 CID	1969-1977	Mexican Application	US953	2.7L V6 164 CID	2015-2016	Lariat, XL, XLT	US8141P
5.0L V8 5000cc 302 CID	1965-1966	Mexican Application	US819	2.7L V6 164 CID	2015-2016	Lariat, XL, XLT; Includes 3 hole pulley	US8141P
5.0L V8 5000cc 302 CID	1965-1967	Mexican Application	US1075	2.7L V6 164 CID	2015-2016	Lariat, XL, XLT; Includes 3 hole pulley and thermostat / housing	US8141P-T
5.0L V8 5000cc 302 CID	1967-1968	Mexican Application	US1028	2.7L V6 164 CID	2015-2017	Lariat, XL, XLT	US8141
5.0L V8 5000cc 302 CID	1968-1974	Mexican Application	US953	2.7L V6 164 CID	2015-2017	Lariat, XL, XLT; 3 Bolt Pulley	US8141
5.0L V8 5000cc 302 CID	1976	Mexican Application	US953	2.7L V6 164 CID	2015-2017	Lariat, XL, XLT; 3 Bolt hub Includes thermostat / housing	US8141-T
5.0L V8 5000cc 302 CID	1978-1980	Mexican Application	US953	3.5L V6 3496cc 213 CID	2011-2012	FX2, FX4, King Ranch, Lariat, Platinum, XL, XLT; Serpentine Belt Driven	US8916
5.0L V8 5000cc 302 CID	1983-1987	Mexican Application	US953	3.5L V6 3496cc 213 CID	2013-2014	FX2, FX4, King Ranch, Lariat, Limited, Platinum, XL, XLT; Serpentine Belt Driven	US8916
5.0L V8 5000cc 302 CID	1987-1992	Mexican Application	US4044	3.5L V6 3496cc 213 CID	2014	FX2, FX4, King Ranch, Lariat, Limited, Platinum, XL, XLT	US8916
5.0L V8 5000cc 302 CID	1994-1997	Mexican Application	US4044	3.5L V6 3496cc 213 CID	2015	XL, XLT	US6654
5.4L V8 5409cc 330 CID	2000	Mexican Application	US4121	3.5L V6 3496cc 213 CID	2015	XL, XLT; Naturally Aspirated; Serpentine Belt Driven	US6654
5.8L V8 5800cc 351 CID	1986-1987	Mexican Application	US953	3.5L V6 3496cc 213 CID	2015	King Ranch, Lariat, Platinum, XL, XLT	US8916
5.8L V8 5800cc 351 CID	1987-1990	Mexican Application	US4044	3.5L V6 3496cc 213 CID	2015	King Ranch, Lariat, Platinum, XL, XLT; Turbocharged; Serpentine Belt Driven	US8916
5.8L V8 5800cc 352 CID	1965-1967	Mexican Application	US1075	3.5L V6 3496cc 213 CID	2016	King Ranch, Lariat, Limited, Platinum, SSV, XL, XLT	US8916
<b>F600</b>				3.5L V6 3496cc 213 CID	2017	King Ranch, Lariat, Limited, Platinum, Raptor, SSV, XL, XLT	US8149
5.9L L6 359 CID	1974-1975	Before serial number V80,001	US1083	3.5L V6 3496cc 213 CID	2017	XL, XLT	US8916
5.9L L6 359 CID	1993-1994		US7145N	3.7L V6 3726cc 227 CID	2011-2013	STX, XL, XLT; Serpentine Belt Driven	US6654
6.1L V8 370 CID	1980-1991		US4037	3.7L V6 3726cc 227 CID	2014	STX, XL, XLT; Serpentine Belt Driven, To 11/15/2013	US6654
6.6L L6 401 CID	1986-1990		US4062	3.7L V6 3726cc 227 CID	2014	STX, XL, XLT; To 11/15/2013	US6654
7.0L V8 429 CID	1980-1994		US4037	3.7L V6 3726cc 227 CID	2014	STX, XL, XLT; From 11/15/2013	US8916
7.8L L6 473 CID	1987-1989		US4062	3.7L V6 3727cc 227 CID	2011-2014	Mexican Application	US6654
<b>F600 LPO</b>				4.2L V6 256 CID	1997-2000	Base, XL, XLT	US4105
5.9L L6 359 CID	1993-1994		US7145N	4.2L V6 256 CID	2001-2003	XL, XLT	US4105
6.6L L6 401 CID	1990		US4062	4.2L V6 256 CID	2005-2008	STX, XL, XLT	US4105
<b>F650</b>				4.6L V8 281 CID	1997-2000	Base, Lariat, XL, XLT	US8920
6L V8 365 CID	2004-2007	Medium/Heavy Duty	US85	4.6L V8 281 CID	2001-2003	King Ranch, Lariat, XL, XLT	US8920
7.3L V8 444 CID	2000-2003	Medium/Heavy Duty	US66	4.6L V8 281 CID	2004-2006	STX, XL, XLT	US8920
<b>F700</b>				4.6L V8 281 CID	2007	STX, XL, XLT	US6144
5.9L L6 359 CID	1993-1997		US7145N	4.6L V8 281 CID	2008	FX2, STX, THE 60TH ANNIVERSARY EDITION, XL, XLT	US6144
6.1L V8 370 CID	1980-1991		US4037	4.6L V8 281 CID	2009	STX, XL, XLT	US8920
6.6L L6 401 CID	1986-1990		US4062	4.6L V8 281 CID	2010	FX2, STX, XL, XLT	US8920
7.0L V8 429 CID	1980-1998		US4037	4.9L L6 4917cc 300 CID	1975-1977	From Engine #080001	US4030N
7.8L L6 473 CID	1987-1990		US4062	4.9L L6 4917cc 300 CID	1975-1977	Before S/N 080001	US4033
<b>F750</b>				4.9L L6 4917cc 300 CID	1978-1979		US4030N
6L V8 365 CID	2004-2007	Medium/Heavy Duty	US85				
7.3L V8 444 CID	2000-2003	Medium/Heavy Duty	US66				
<b>F800</b>							
5.9L L6 359 CID	1993-1999		US7145N				
6.1L V8 370 CID	1980-1991		US4037				
6.6L L6 401 CID	1987-1990		US4062				
7.0L V8 429 CID	1980-1990		US4037				
7.0L V8 429 CID	1997-1998		US4037				
7.8L L6 473 CID	1986-1990		US4062				

WATER PUMPS



Engine	Years	Application Description	USMWW	Engine	Years	Application Description	USMWW
<b>FORD (cont'd.)</b>				<b>FORD (cont'd.)</b>			
<b>F-150 (cont'd.)</b>				<b>F-150 (cont'd.)</b>			
4.9L L6 4917cc 300 CID	1980-1981	Custom, Ranger, Ranger Lariat, Ranger XLT	<b>US4030N</b>	5.8L V8 351 CID	1982	Custom, XL, XLS, XLT Lariat; WINDSOR	<b>US953</b>
4.9L L6 4917cc 300 CID	1982	Custom, XL, XLS, XLT Lariat	<b>US4030N</b>	5.8L V8 351 CID	1982	Custom, XL, XLS, XLT Lariat; High performance	<b>US953H</b>
4.9L L6 4917cc 300 CID	1983	Base, XL, XLS, XLT	<b>US4020</b>	5.8L V8 351 CID	1983	Base, XL, XLS, XLT; WINDSOR	<b>US953</b>
4.9L L6 4917cc 300 CID	1984	Base, XL, XLT	<b>US4020</b>	5.8L V8 351 CID	1983	Base, XL, XLS, XLT; High performance	<b>US953H</b>
4.9L L6 4917cc 300 CID	1985-1986	Base, XL, XLT Lariat	<b>US4020</b>	5.8L V8 351 CID	1984	Base, XL, XLT; WINDSOR	<b>US953</b>
4.9L L6 4917cc 300 CID	1987-1992	Custom, XL, XLT Lariat	<b>US4048</b>	5.8L V8 351 CID	1984	Base, XL, XLT; High performance	<b>US953H</b>
4.9L L6 4917cc 300 CID	1993-1994	XL, XLT	<b>US4099</b>	5.8L V8 351 CID	1984	Base, XL, XLT; High performance	<b>US953H</b>
4.9L L6 4917cc 300 CID	1995-1996	Eddie Bauer, Special, XL, XLT	<b>US4099</b>	5.8L V8 351 CID	1985-1986	Base, XL, XLT Lariat; WINDSOR	<b>US953</b>
5.0L V8 302 CID	1975-1979	WINDSOR	<b>US953</b>	5.8L V8 351 CID	1985-1986	Base, XL, XLT Lariat; High performance	<b>US953H</b>
5.0L V8 302 CID	1975-1979	High performance	<b>US953H</b>	5.8L V8 351 CID	1987	Custom, XL, XLT Lariat; WINDSOR	<b>US953</b>
5.0L V8 302 CID	1980-1981	Custom, Ranger, Ranger Lariat, Ranger XLT; WINDSOR	<b>US953</b>	5.8L V8 351 CID	1987	Custom, XL, XLT Lariat; High performance	<b>US953H</b>
5.0L V8 302 CID	1980-1981	Custom, Ranger, Ranger Lariat, Ranger XLT; High performance	<b>US953H</b>	5.8L V8 351 CID	1988-1992	Custom, XL, XLT Lariat	<b>US4044</b>
5.0L V8 302 CID	1982	Custom, XL, XLS, XLT Lariat; WINDSOR	<b>US953</b>	5.8L V8 351 CID	1988-1992	Custom, XL, XLT Lariat; High performance	<b>US4044H</b>
5.0L V8 302 CID	1982	Custom, XL, XLS, XLT Lariat; High performance	<b>US953H</b>	5.8L V8 351 CID	1993-1994	Lightning, XL, XLT	<b>US4044</b>
5.0L V8 302 CID	1983	Base, XL, XLS, XLT; WINDSOR	<b>US953</b>	5.8L V8 351 CID	1993-1994	Lightning, XL, XLT; High performance	<b>US4044H</b>
5.0L V8 302 CID	1983	Base, XL, XLS, XLT; High performance	<b>US953H</b>	5.8L V8 351 CID	1995	Eddie Bauer, Lightning, Special, XL, XLT	<b>US4044</b>
5.0L V8 302 CID	1984	Base, XL, XLT; WINDSOR	<b>US953</b>	5.8L V8 351 CID	1995	Eddie Bauer, Lightning, Special, XL, XLT; High performance	<b>US4044H</b>
5.0L V8 302 CID	1984	Base, XL, XLT; High performance	<b>US953H</b>	5.8L V8 351 CID	1996	Eddie Bauer, Special, XL, XLT	<b>US4044</b>
5.0L V8 302 CID	1985-1986	Base, XL, XLT Lariat; WINDSOR	<b>US953</b>	5.8L V8 351 CID	1996	Eddie Bauer, Special, XL, XLT; High performance	<b>US4044H</b>
5.0L V8 302 CID	1985-1986	Base, XL, XLT Lariat; High performance	<b>US953H</b>	5.9L V8 360 CID	1975-1976		<b>US1075</b>
5.0L V8 302 CID	1987-1992	Custom, XL, XLT Lariat	<b>US4044</b>	5.9L V8 360 CID	1975-1976	High performance	<b>US1075H</b>
5.0L V8 302 CID	1987-1992	Custom, XL, XLT Lariat; High performance	<b>US4044H</b>	6.2L V8 6210cc 379 CID	2010	SVT Raptor	<b>US6006</b>
5.0L V8 302 CID	1993-1994	XL, XLT	<b>US4044</b>	6.2L V8 6210cc 379 CID	2011	Harley-Davidson Edition, Lariat, Lariat Limited, Platinum, SVT Raptor	<b>US6006</b>
5.0L V8 302 CID	1993-1994	XL, XLT; High performance	<b>US4044H</b>	6.2L V8 6210cc 379 CID	2012	Harley-Davidson Edition, Lariat, Platinum, SVT Raptor	<b>US6006</b>
5.0L V8 302 CID	1995	Eddie Bauer, Special, XL, XLT	<b>US4044</b>	6.2L V8 6210cc 379 CID	2013	FX2, FX4, Lariat, Platinum, SVT Raptor	<b>US6006</b>
5.0L V8 302 CID	1995	Eddie Bauer, Special, XL, XLT; High performance	<b>US4044H</b>	6.2L V8 6210cc 379 CID	2014	FX2, FX4, Lariat, Platinum, SVT Raptor, XLT	<b>US6006</b>
5.0L V8 302 CID	1996	Eddie Bauer, Special, XL, XLT; Stamped #E9TE8505-A4A,A5A,F5TE8505-C4A	<b>US4044</b>	6.4L V8 390 CID	1975-1976		<b>US1075</b>
5.0L V8 302 CID	1996	Eddie Bauer, Special, XL, XLT; Stamped #F5TE8505-C5A	<b>US4044</b>	6.4L V8 390 CID	1975-1976	High performance	<b>US1075H</b>
5.0L V8 302 CID	1996	Eddie Bauer, Special, XL, XLT; High performance, Stamped #E9TE8505-A4A,A5A,F5TE8505-C4A	<b>US4044H</b>	6.8L V8 400 CID	1977-1979	MODIFIED	<b>US932</b>
5.0L V8 302 CID	1996	Eddie Bauer, Special, XL, XLT; High performance, Stamped #F5TE8505-C5A	<b>US4044H</b>	7.5L V8 460 CID	1975-1979		<b>US1114</b>
5.0L V8 302 CID	1996	Eddie Bauer, Special, XL, XLT; High performance, Stamped #F5TE8505-C5A	<b>US4044H</b>	<b>F-150 HERITAGE</b>			
5.0L V8 4951cc 302 CID	2011-2012	FX2, FX4, King Ranch, Lariat, Platinum, STX, XL, XLT	<b>US8963</b>	4.2L V6 256 CID	2004	XL, XLT	<b>US4105</b>
5.0L V8 4951cc 302 CID	2013	FX2, FX4, King Ranch, Lariat, Platinum, STX, XL, XLT; From 8-12-2013	<b>US8116</b>	4.6L V8 281 CID	2004	XL, XLT	<b>US8920</b>
5.0L V8 4951cc 302 CID	2013	FX2, FX4, King Ranch, Lariat, Platinum, STX, XL, XLT; To 8-11-2013	<b>US8963</b>	5.4L V8 330 CID	2004	SVT Lightning	<b>US4125</b>
5.0L V8 4951cc 302 CID	2014	FX2, FX4, King Ranch, Lariat, Platinum, STX, XL, XLT	<b>US8116</b>	5.4L V8 330 CID	2004	XL, XLT	<b>US8920</b>
5.0L V8 4951cc 302 CID	2015	King Ranch, Lariat, Platinum, XL, XLT	<b>US8116</b>	5.4L V8 330 CID	2004	SVT Lightning	<b>US11014</b>
5.0L V8 4951cc 302 CID	2016-2018	King Ranch, Lariat, Platinum, SSV, XL, XLT	<b>US8116</b>	<b>F-250</b>			
5.0L V8 5000cc 305 CID	2011-2014	Mexican Application	<b>US8963</b>	4.4L V8 4458cc 272 CID	1956-1958		<b>US488</b>
5.4L V8 330 CID	1997-1999	Base, Lariat, XL, XLT	<b>US8920</b>	4.6L V8 281 CID	1997-1999	Base, Lariat, XL, XLT	<b>US8920</b>
5.4L V8 330 CID	1999-2000	Lightning	<b>US4121</b>	4.8L V8 4786cc 292 CID	1958-1963		<b>US488</b>
5.4L V8 330 CID	1999-2001	Lightning	<b>US11014</b>	4.9L L6 4917cc 300 CID	1975-1977	From Engine #080001	<b>US4030N</b>
5.4L V8 330 CID	2000	Base, Harley-Davidson Edition, Lariat, XL, XLT	<b>US8920</b>	4.9L L6 4917cc 300 CID	1975-1977	Before S/N 080001	<b>US4033</b>
5.4L V8 330 CID	2001	Lightning; To 11/10/2000	<b>US4121</b>	4.9L L6 4917cc 300 CID	1978-1979		<b>US4030N</b>
5.4L V8 330 CID	2001	Lightning; From 11/10/2000	<b>US4125</b>	4.9L L6 4917cc 300 CID	1980-1981	Custom, Ranger, Ranger Lariat, Ranger XLT	<b>US4030N</b>
5.4L V8 330 CID	2001	Harley-Davidson Edition, King Ranch, Lariat, XL, XLT	<b>US8920</b>	4.9L L6 4917cc 300 CID	1982	Custom, XL, XLS, XLT Lariat	<b>US4030N</b>
5.4L V8 330 CID	2002-2003	Harley-Davidson Edition, Lightning	<b>US4125</b>	4.9L L6 4917cc 300 CID	1983	Base, XL, XLS, XLT	<b>US4020</b>
5.4L V8 330 CID	2002-2003	King Ranch, Lariat, XL, XLT	<b>US8920</b>	4.9L L6 4917cc 300 CID	1984	Base, XL, XLT	<b>US4020</b>
5.4L V8 330 CID	2002-2003	Harley-Davidson Edition, Lightning	<b>US11014</b>	4.9L L6 4917cc 300 CID	1985-1986	Base, XL, XLT Lariat	<b>US4020</b>
5.4L V8 330 CID	2004	FX4, Lariat, XL, XLT	<b>US8920</b>	4.9L L6 4917cc 300 CID	1987-1992	Custom, XL, XLT Lariat	<b>US4048</b>
5.4L V8 330 CID	2005	FX4, King Ranch, Lariat, XL, XLT	<b>US8920</b>	4.9L L6 4917cc 300 CID	1993-1994	XL, XLT	<b>US4099</b>
5.4L V8 330 CID	2006	FX4, Harley-Davidson Edition, King Ranch, Lariat, XL, XLT	<b>US6144</b>	4.9L L6 4917cc 300 CID	1995-1996	Eddie Bauer, Special, XL, XLT	<b>US4099</b>
5.4L V8 330 CID	2006	FX4, Harley-Davidson Edition, King Ranch, Lariat, XL, XLT	<b>US8920</b>	5.0L V8 302 CID	1977-1978	WINDSOR	<b>US953</b>
5.4L V8 330 CID	2007	FX2, FX4, Harley-Davidson Edition, King Ranch, Lariat, XL, XLT	<b>US6144</b>	5.0L V8 302 CID	1977-1978	High performance	<b>US953H</b>
5.4L V8 330 CID	2008	FX2, FX4, Harley-Davidson Edition, King Ranch, Lariat, Limited, THE 60TH ANNIVERSARY EDITION, XL, XLT	<b>US6144</b>	5.0L V8 302 CID	1980-1981	Custom, Ranger, Ranger Lariat, Ranger XLT; WINDSOR	<b>US953</b>
5.4L V8 330 CID	2009	FX4, King Ranch, Lariat, Platinum, XL, XLT	<b>US6144</b>	5.0L V8 302 CID	1980-1981	Custom, Ranger, Ranger Lariat, Ranger XLT; High performance	<b>US953H</b>
5.4L V8 330 CID	2010	FX2, FX4, Harley-Davidson Edition, King Ranch, Lariat, Platinum, SVT Raptor, XL, XLT	<b>US8920</b>	5.0L V8 302 CID	1982	Custom, XL, XLS, XLT Lariat; WINDSOR	<b>US953</b>
5.8L V8 351 CID	1977-1979	MODIFIED	<b>US932</b>	5.0L V8 302 CID	1982	Custom, XL, XLS, XLT Lariat; High performance	<b>US953H</b>
5.8L V8 351 CID	1977-1979	WINDSOR	<b>US953</b>	5.0L V8 302 CID	1983	Base, XL, XLS, XLT; WINDSOR	<b>US953</b>
5.8L V8 351 CID	1977-1979	High performance	<b>US953H</b>	5.0L V8 302 CID	1983	Base, XL, XLS, XLT; High performance	<b>US953H</b>
5.8L V8 351 CID	1980-1981	Custom, Ranger, Ranger Lariat, Ranger XLT; WINDSOR	<b>US953</b>	5.0L V8 302 CID	1984	Base, XL, XLT; WINDSOR	<b>US953</b>
5.8L V8 351 CID	1980-1981	Custom, Ranger, Ranger Lariat, Ranger XLT; High performance	<b>US953H</b>	5.0L V8 302 CID	1984	Base, XL, XLT; High performance	<b>US953H</b>
5.8L V8 351 CID	1980-1981	Custom, Ranger, Ranger Lariat, Ranger XLT; High performance	<b>US953H</b>	5.0L V8 302 CID	1985-1986	Base, XL, XLT Lariat; WINDSOR	<b>US953</b>
				5.0L V8 302 CID	1985-1986	Base, XL, XLT Lariat; High performance	<b>US953H</b>
				5.0L V8 302 CID	1987-1989	Custom, XL, XLT Lariat	<b>US4044</b>
				5.0L V8 302 CID	1987-1989	Custom, XL, XLT Lariat; High performance	<b>US4044H</b>
				5.0L V8 302 CID	1991-1992	Custom, XL, XLT Lariat	<b>US4044</b>
				5.0L V8 302 CID	1991-1992	Custom, XL, XLT Lariat; High performance	<b>US4044H</b>
				5.0L V8 302 CID	1993-1994	XL, XLT	<b>US4044</b>
				5.0L V8 302 CID	1993-1994	XL, XLT; High performance	<b>US4044H</b>
				5.0L V8 302 CID	1995-1996	Eddie Bauer, Special, XL, XLT	<b>US4044</b>

Engine	Years	Application Description	USMW	Engine	Years	Application Description	USMW
<b>FORD (cont'd.)</b>				<b>FORD (cont'd.)</b>			
<b>F-250 (cont'd.)</b>				<b>F-250 SUPER DUTY (cont'd.)</b>			
5.0L V8 302 CID	1995-1996	Eddie Bauer, Special, XL, XLT; High performance	US4044H	6.4L V8 391 CID	2009	Cabela's, FX4, Harley-Davidson Edition, King Ranch, Lariat, XL, XLT	US76
5.4L V8 330 CID	1997-1999	Base, Lariat, XL, XLT	US8920	6.4L V8 391 CID	2010	Cabela's, Harley-Davidson Edition, King Ranch, Lariat, XL, XLT	US76
5.8L V8 351 CID	1977-1979	MODIFIED	US932	6.4L V8 391 CID	2010	Harley-Davidson Edition, King Ranch, Lariat, XL, XLT; Electric Water Pump	US11006
5.8L V8 351 CID	1977-1979	WINDSOR	US953	6.7L V8 6651cc 406 CID	2011-2012	King Ranch, Lariat, XL, XLT	US77
5.8L V8 351 CID	1977-1979	High performance	US953H	6.7L V8 6651cc 406 CID	2011-2012	King Ranch, Lariat, XL, XLT; Pump only	US78
5.8L V8 351 CID	1980-1981	Custom, Ranger, Ranger Lariat, Ranger XLT; WINDSOR	US953	6.7L V8 6651cc 406 CID	2013-2016	King Ranch, Lariat, Platinum, XL, XLT	US77
5.8L V8 351 CID	1980-1981	Custom, Ranger, Ranger Lariat, Ranger XLT; High performance	US953H	6.7L V8 6651cc 406 CID	2013-2016	King Ranch, Lariat, Platinum, XL, XLT; Pump only	US78
5.8L V8 351 CID	1982	Custom, XL, XLS, XLT Lariat; WINDSOR	US953	6.7L V8 6651cc 406 CID	2017	King Ranch, Lariat, Platinum, XL, XLT	US8157
5.8L V8 351 CID	1982	Custom, XL, XLS, XLT Lariat; High performance	US953H	6.7L V8 6651cc 406 CID	2018	King Ranch, Lariat, Limited, Platinum, XL, XLT	US8157
5.8L V8 351 CID	1983	Base, XL, XLS, XLT; WINDSOR	US953	6.7L V8 6700cc 409 CID	2011-2016	Mexican Application	US77
5.8L V8 351 CID	1983	Base, XL, XLS, XLT; High performance	US953H	6.8L V10 415 CID	1999-2003	Lariat, XL, XLT	US4109
5.8L V8 351 CID	1984	Base, XL, XLT; WINDSOR	US953	6.8L V10 415 CID	2004-2005	Harley-Davidson Edition, King Ranch, Lariat, XL, XLT	US4109
5.8L V8 351 CID	1984	Base, XL, XLT; High performance	US953H	6.8L V10 415 CID	2006-2007	King Ranch, Lariat, XL, XLT	US4109
5.8L V8 351 CID	1985-1986	Base, XL, XLT Lariat; WINDSOR	US953	6.8L V10 415 CID	2008	FX4, Harley-Davidson Edition, King Ranch, Lariat, XL, XLT	US4109
5.8L V8 351 CID	1985-1986	Base, XL, XLT Lariat; High performance	US953H	6.8L V10 415 CID	2009	Cabela's, FX4, Harley-Davidson Edition, King Ranch, Lariat, XL, XLT	US4109
5.8L V8 351 CID	1987	Custom, XL, XLT Lariat; WINDSOR	US953	6.8L V10 415 CID	2010	Cabela's, King Ranch, Lariat, XL, XLT	US6144
5.8L V8 351 CID	1987	Custom, XL, XLT Lariat; High performance	US953H	7.3L V8 445 CID	1999-2003	Lariat, XL, XLT	US4114
5.8L V8 351 CID	1988-1992	Custom, XL, XLT Lariat	US4044	<b>F-350</b>			
5.8L V8 351 CID	1988-1992	Custom, XL, XLT Lariat; High performance	US4044H	4.4L V8 4458cc 272 CID	1956-1958		US488
5.8L V8 351 CID	1993-1994	XL, XLT	US4044	4.8L V8 4786cc 292 CID	1958-1963		US488
5.8L V8 351 CID	1993-1994	XL, XLT; High performance	US4044H	4.9L L6 4917cc 300 CID	1975-1977	From Engine #080001	US4030N
5.8L V8 351 CID	1995-1996	Eddie Bauer, Special, XL, XLT	US4044	4.9L L6 4917cc 300 CID	1975-1977	Before S/N 080001	US4033
5.8L V8 351 CID	1995-1996	Eddie Bauer, Special, XL, XLT; High performance	US4044H	4.9L L6 4917cc 300 CID	1978		US4030N
5.9L V8 360 CID	1975-1976	High performance	US1075	4.9L L6 4917cc 300 CID	1980-1981	Custom, Ranger, Ranger Lariat, Ranger XLT	US4030N
5.9L V8 360 CID	1975-1976	High performance	US1075H	4.9L L6 4917cc 300 CID	1982	Custom, XL, XLS, XLT Lariat	US4030N
6.4L V8 390 CID	1975-1976	High performance	US1075	4.9L L6 4917cc 300 CID	1983	Base, XL, XLS, XLT	US4020
6.4L V8 390 CID	1975-1976	High performance	US1075H	4.9L L6 4917cc 300 CID	1984	Base, XL, XLT	US4020
6.6L V8 400 CID	1977-1979	MODIFIED	US932	4.9L L6 4917cc 300 CID	1985-1986	Base, XL, XLT Lariat	US4020
6.6L V8 400 CID	1980-1981	Custom, Ranger, Ranger Lariat, Ranger XLT; MODIFIED	US932	4.9L L6 4917cc 300 CID	1987-1989	Custom, XL, XLT Lariat	US4048
6.6L V8 400 CID	1982	Custom, XL, XLS, XLT Lariat; MODIFIED	US932	4.9L L6 4917cc 300 CID	1993-1994	XL, XLT	US4099
6.9L V8 420 CID	1983	Base, XL, XLS, XLT	US4018	5.0L V8 302 CID	1976	High performance	US953H
6.9L V8 420 CID	1984	Base, XL, XLT	US4018	5.0L V8 302 CID	1980	Custom, Ranger, Ranger Lariat, Ranger XLT; WINDSOR	US953
6.9L V8 420 CID	1985-1986	Base, XL, XLT Lariat	US4018	5.0L V8 302 CID	1980	Custom, Ranger, Ranger Lariat, Ranger XLT; High performance	US953H
6.9L V8 420 CID	1987	Custom, XL, XLT Lariat	US4018	5.8L V8 351 CID	1977-1979	MODIFIED	US932
7.3L V8 445 CID	1988-1992	Custom, XL, XLT Lariat	US4018	5.8L V8 351 CID	1979		US4030N
7.3L V8 445 CID	1993	XL, XLT	US4018	5.8L V8 351 CID	1980-1981	Custom, Ranger, Ranger Lariat, Ranger XLT; WINDSOR	US953
7.3L V8 445 CID	1994	XL, XLT; (K), Turbocharged	US4018	5.8L V8 351 CID	1980-1981	Custom, Ranger, Ranger Lariat, Ranger XLT; High performance	US953H
7.3L V8 445 CID	1994	XL, XLT; (M), Naturally Aspirated	US4018	5.8L V8 351 CID	1982	Custom, XL, XLS, XLT Lariat; WINDSOR	US953
7.3L V8 445 CID	1994	XL, XLT; (F), Turbocharged	US4096	5.8L V8 351 CID	1982	Custom, XL, XLS, XLT Lariat; High performance	US953
7.3L V8 445 CID	1995	Eddie Bauer, Special, XL, XLT	US4096	5.8L V8 351 CID	1982	Custom, XL, XLS, XLT Lariat; High performance	US953H
7.3L V8 445 CID	1996	Eddie Bauer, Special, XL, XLT; To Engine # 201680	US4096	5.8L V8 351 CID	1982	Custom, XL, XLS, XLT Lariat; High performance	US953H
7.3L V8 445 CID	1996	Eddie Bauer, Special, XL, XLT; From Engine # 201681	US4114	5.8L V8 351 CID	1983	Base, XL, XLS, XLT; WINDSOR	US953
7.5L V8 460 CID	1975-1979		US1114	5.8L V8 351 CID	1983	Base, XL, XLS, XLT; High performance	US953H
7.5L V8 460 CID	1983	Base, XL, XLS, XLT	US1114	5.8L V8 351 CID	1984	Base, XL, XLT; WINDSOR	US953
7.5L V8 460 CID	1984	Base, XL, XLT	US1114	5.8L V8 351 CID	1984	Base, XL, XLT; High performance	US953H
7.5L V8 460 CID	1985-1986	Base, XL, XLT Lariat	US1114	5.8L V8 351 CID	1985-1986	Base, XL, XLT Lariat; WINDSOR	US953
7.5L V8 460 CID	1987	Custom, XL, XLT Lariat	US1114	5.8L V8 351 CID	1985-1986	Base, XL, XLT Lariat; High performance	US953H
7.5L V8 460 CID	1988-1989	Custom, XL, XLT Lariat	US4081	5.8L V8 351 CID	1987	Custom, XL, XLT Lariat; WINDSOR	US953
7.5L V8 460 CID	1990-1991	Custom, XL, XLT Lariat	US1114	5.8L V8 351 CID	1987	Custom, XL, XLT Lariat; High performance	US953H
7.5L V8 460 CID	1992	Custom, XL, XLT Lariat; To 02/03/1992	US1114	5.8L V8 351 CID	1988-1992	Custom, XL, XLT Lariat	US4044
7.5L V8 460 CID	1992	Custom, XL, XLT Lariat; From 02/03/1992	US4077	5.8L V8 351 CID	1988-1992	Custom, XL, XLT Lariat; High performance	US4044H
7.5L V8 460 CID	1993-1994	XL, XLT	US4077	5.8L V8 351 CID	1993-1994	XL, XLT	US4044
7.5L V8 460 CID	1995-1996	Eddie Bauer, Special, XL, XLT	US4086	5.8L V8 351 CID	1993-1994	XL, XLT; High performance	US4044H
7.5L V8 460 CID	1997	Base, Lariat, XL, XLT	US4086	5.8L V8 351 CID	1995	Eddie Bauer, Special, XL, XLT	US4044
<b>F-250 SUPER DUTY</b>				5.8L V8 351 CID	1995	Eddie Bauer, Special, XL, XLT; High performance	US4044H
5.4L V8 330 CID	1999-2003	Lariat, XL, XLT	US8920	5.8L V8 351 CID	1996	Special, XL, XLT	US4044
5.4L V8 330 CID	2004-2007	King Ranch, Lariat, XL, XLT	US8920	5.8L V8 351 CID	1996	Special, XL, XLT; High performance	US4044H
5.4L V8 330 CID	2008	FX4, King Ranch, Lariat, XL, XLT	US8920	5.8L V8 351 CID	1997	Base, XL, XLT	US4044
5.4L V8 330 CID	2009	Cabela's, FX4, King Ranch, Lariat, XL, XLT	US8920	5.8L V8 351 CID	1997	Base, XL, XLT; High performance	US4044H
5.4L V8 330 CID	2010	Cabela's, King Ranch, Lariat, XL, XLT	US8920	5.9L V8 360 CID	1975-1976		US1075
6.0L V8 363 CID	2003	Lariat, XL, XLT	US61	5.9L V8 360 CID	1975-1976	High performance	US1075H
6.0L V8 363 CID	2004	Harley-Davidson Edition, King Ranch, Lariat, XL, XLT; To 09/22/2003	US61	6.2L V8 6200cc 378 CID	2015	Mexican Application	US6006
6.0L V8 363 CID	2004	Harley-Davidson Edition, King Ranch, Lariat, XL, XLT; From 09/22/03	US67	6.4L V8 390 CID	1975-1976		US1075
6.0L V8 363 CID	2005-2007	Harley-Davidson Edition, King Ranch, Lariat, XL, XLT	US67	6.4L V8 390 CID	1975-1976	High performance	US1075H
6.2L V8 6210cc 379 CID	2011-2012	King Ranch, Lariat, XL, XLT	US6006	6.6L V8 400 CID	1977-1979	MODIFIED	US932
6.2L V8 6210cc 379 CID	2013-2018	King Ranch, Lariat, Platinum, XL, XLT	US6006	6.6L V8 400 CID	1980-1981	Custom, Ranger, Ranger Lariat, Ranger XLT; MODIFIED	US932
6.4L V8 391 CID	2008	FX4, Harley-Davidson Edition, King Ranch, Lariat, XL, XLT	US76	6.6L V8 400 CID	1982	Custom, XL, XLS, XLT Lariat; MODIFIED	US932
6.4L V8 391 CID	2008-2009	FX4, Harley-Davidson Edition, King Ranch, Lariat, XL, XLT; Electric Water Pump	US11006	6.9L V8 420 CID	1983	Base, XL, XLS, XLT	US4018
				6.9L V8 420 CID	1984	Base, XL, XLT	US4018
				6.9L V8 420 CID	1985-1986	Base, XL, XLT Lariat	US4018

WATER PUMPS





# WATER PUMP APPLICATION GUIDE



Engine	Years	Application Description	USMWW	Engine	Years	Application Description	USMWW
<b>FORD (cont'd.)</b>				<b>FORD (cont'd.)</b>			
<b>F-350 (cont'd.)</b>				<b>F-450 SUPER DUTY (cont'd.)</b>			
6.9L V8 420 CID	1987	Custom, XL, XLT Lariat	<b>US4018</b>	6.4L V8 391 CID	2008-2010	Electric Water Pump, Lariat, Medium/Heavy Duty	<b>US11006</b>
7.3L V8 445 CID	1988-1992	Custom, XL, XLT Lariat	<b>US4018</b>	6.4L V8 391 CID	2008-2010	Electric Water Pump, Medium/Heavy Duty, XL	<b>US11006</b>
7.3L V8 445 CID	1993	XL, XLT	<b>US4018</b>	6.4L V8 391 CID	2008-2010	Electric Water Pump, Medium/Heavy Duty, XLT	<b>US11006</b>
7.3L V8 445 CID	1994	XL, XLT; (K), Turbocharged	<b>US4018</b>	6.4L V8 391 CID	2009-2010	Electric Water Pump, Harley-Davidson Edition, Medium/Heavy Duty	<b>US11006</b>
7.3L V8 445 CID	1994	XL, XLT; (M), Naturally Aspirated	<b>US4018</b>	6.4L V8 391 CID	2009-2010	Harley-Davidson Edition, King Ranch, Lariat, XL, XLT	<b>US11006</b>
7.3L V8 445 CID	1994	XL, XLT; (F), Turbocharged	<b>US4096</b>	6.4L V8 391 CID	2010	Lariat, Medium/Heavy Duty	<b>US76</b>
7.3L V8 445 CID	1995	Eddie Bauer, Special, XL, XLT	<b>US4096</b>	6.4L V8 391 CID	2010	Medium/Heavy Duty, XLT	<b>US76</b>
7.3L V8 445 CID	1996	Special, XL, XLT; To Engine # 201680	<b>US4096</b>	6.7L V8 6651cc 406 CID	2011-2015	Medium/Heavy Duty, XL	<b>US77</b>
7.3L V8 445 CID	1996	Special, XL, XLT; From Engine # 201681	<b>US4114</b>	6.7L V8 6651cc 406 CID	2011-2015	Medium/Heavy Duty, XLT	<b>US77</b>
7.3L V8 445 CID	1996	Special, XL, XLT; From Engine # 201681	<b>US4114</b>	6.7L V8 6651cc 406 CID	2014-2015	Base, King Ranch, Lariat, Platinum, XL, XLT	<b>US77</b>
7.3L V8 445 CID	1997	Base, Lariat, XL, XLT	<b>US4114</b>	6.7L V8 6651cc 406 CID	2016	King Ranch, Lariat, Platinum, XL, XLT	<b>US77</b>
7.5L V8 460 CID	1975-1979	Base, XL, XLS, XLT	<b>US1114</b>	6.7L V8 6651cc 406 CID	2017-2018	Base	<b>US8157</b>
7.5L V8 460 CID	1983	Base, XL, XLT	<b>US1114</b>	6.8L V10 415 CID	1999-2008	Lariat, Medium/Heavy Duty	<b>US4109</b>
7.5L V8 460 CID	1984	Base, XL, XLT	<b>US1114</b>	6.8L V10 415 CID	1999-2008	Medium/Heavy Duty, XL	<b>US4109</b>
7.5L V8 460 CID	1985-1986	Base, XL, XLT Lariat	<b>US1114</b>	6.8L V10 415 CID	1999-2008	Medium/Heavy Duty, XLT	<b>US4109</b>
7.5L V8 460 CID	1987	Custom, XL, XLT Lariat	<b>US1114</b>	6.8L V10 415 CID	2008	King Ranch, Medium/Heavy Duty	<b>US4109</b>
7.5L V8 460 CID	1988-1989	Custom, XL, XLT Lariat	<b>US4081</b>	6.8L V10 415 CID	2010	Lariat, Medium/Heavy Duty	<b>US6144</b>
7.5L V8 460 CID	1990-1991	Custom, XL, XLT Lariat	<b>US1114</b>	6.8L V10 415 CID	2010-2015	Medium/Heavy Duty, XL	<b>US6144</b>
7.5L V8 460 CID	1992	Custom, XL, XLT Lariat; To 02/03/1992	<b>US1114</b>	6.8L V10 415 CID	2010-2015	Medium/Heavy Duty, XLT	<b>US6144</b>
7.5L V8 460 CID	1992	Custom, XL, XLT Lariat; From 02/03/1992	<b>US4077</b>	6.8L V10 415 CID	2014-2015	XL, XLT	<b>US6144</b>
7.5L V8 460 CID	1993-1994	XL, XLT	<b>US4077</b>	6.8L V10 415 CID	2016	XL, XLT	<b>US4109</b>
7.5L V8 460 CID	1995	Eddie Bauer, Special, XL, XLT	<b>US4086</b>	6.8L V10 415 CID	2017-2018	Base	<b>US4109</b>
7.5L V8 460 CID	1996	Special, XL, XLT	<b>US4086</b>	6L V8 363 CID	2003	Lariat, Medium/Heavy Duty	<b>US61</b>
7.5L V8 460 CID	1997	Base, Lariat, XL, XLT	<b>US4086</b>	6L V8 363 CID	2003	Medium/Heavy Duty, XL	<b>US61</b>
<b>F-350 SUPER DUTY</b>				<b>F-500</b>			
5.4L V8 330 CID	1999-2003	Lariat, XL, XLT	<b>US8920</b>	5.4L V8 330 CID	1975	From serial number T80,001 to W00,001	<b>US1082</b>
5.4L V8 330 CID	2004-2007	King Ranch, Lariat, XL, XLT	<b>US8920</b>	5.4L V8 330 CID	1975-1977		<b>US1096</b>
5.4L V8 330 CID	2008	FX4, King Ranch, Lariat, XL, XLT	<b>US8920</b>	<b>F-550</b>			
5.4L V8 330 CID	2009	Cabela's, FX4, King Ranch, Lariat, XL, XLT	<b>US8920</b>	6.7L V8 6700cc 409 CID	2013-2014	Mexican Application	<b>US77</b>
5.4L V8 330 CID	2010	Cabela's, King Ranch, Lariat, XL, XLT	<b>US8920</b>	6.8L V10 6751cc 412 CID	2014	Mexican Application	<b>US4109</b>
6.0L V8 363 CID	2003	Lariat, XL, XLT	<b>US61</b>	<b>F-550 SUPER DUTY</b>			
6.0L V8 363 CID	2004	Harley-Davidson Edition, King Ranch, Lariat, XL, XLT; To 09/22/2003	<b>US61</b>	6.4L V8 391 CID	2008-2010	Lariat, Medium/Heavy Duty	<b>US76</b>
6.0L V8 363 CID	2004	Harley-Davidson Edition, King Ranch, Lariat, XL, XLT; From 09/22/03	<b>US67</b>	6.4L V8 391 CID	2008-2010	Medium/Heavy Duty, XL	<b>US76</b>
6.0L V8 363 CID	2004	Harley-Davidson Edition, King Ranch, Lariat, XL, XLT	<b>US67</b>	6.4L V8 391 CID	2008-2010	Medium/Heavy Duty, XLT	<b>US76</b>
6.0L V8 363 CID	2005-2007	Harley-Davidson Edition, King Ranch, Lariat, XL, XLT	<b>US67</b>	6.4L V8 391 CID	2008-2010	Electric Water Pump, Lariat, Medium/Heavy Duty	<b>US11006</b>
6.2L V8 6210cc 379 CID	2011-2012	King Ranch, Lariat, XL, XLT	<b>US6006</b>	6.4L V8 391 CID	2008-2010	Electric Water Pump, Medium/Heavy Duty, XL	<b>US11006</b>
6.2L V8 6210cc 379 CID	2013-2018	King Ranch, Lariat, Platinum, XL, XLT	<b>US6006</b>	6.4L V8 391 CID	2008-2010	Electric Water Pump, Medium/Heavy Duty, XLT	<b>US11006</b>
6.4L V8 391 CID	2008	FX4, Harley-Davidson Edition, King Ranch, Lariat, XL, XLT	<b>US76</b>	6.4L V8 391 CID	2008-2010	Lariat, XL, XLT	<b>US11006</b>
6.4L V8 391 CID	2008-2009	FX4, Harley-Davidson Edition, King Ranch, Lariat, XL, XLT; Electric Water Pump	<b>US11006</b>	6.4L V8 391 CID	2008-2010	XL	<b>US11006</b>
6.4L V8 391 CID	2009	Cabela's, FX4, Harley-Davidson Edition, King Ranch, Lariat, XL, XLT	<b>US76</b>	6.4L V8 391 CID	2008-2010	Medium/Heavy Duty, XL	<b>US77</b>
6.4L V8 391 CID	2010	Cabela's, Harley-Davidson Edition, King Ranch, Lariat, XL, XLT	<b>US76</b>	6.4L V8 391 CID	2008-2010	Medium/Heavy Duty, XLT	<b>US77</b>
6.4L V8 391 CID	2010	Harley-Davidson Edition, King Ranch, Lariat, XL, XLT; Electric Water Pump	<b>US11006</b>	6.4L V8 391 CID	2008-2010	Medium/Heavy Duty, XLT	<b>US77</b>
6.7L V8 6651cc 406 CID	2011-2012	King Ranch, Lariat, XL, XLT	<b>US77</b>	6.4L V8 391 CID	2008-2010	Medium/Heavy Duty, XLT	<b>US77</b>
6.7L V8 6651cc 406 CID	2011-2012	King Ranch, Lariat, XL, XLT; Pump only	<b>US78</b>	6.4L V8 391 CID	2008-2010	Medium/Heavy Duty, XLT	<b>US77</b>
6.7L V8 6651cc 406 CID	2013-2016	King Ranch, Lariat, Platinum, XL, XLT	<b>US77</b>	6.4L V8 391 CID	2008-2010	Medium/Heavy Duty, XLT	<b>US77</b>
6.7L V8 6651cc 406 CID	2013-2016	King Ranch, Lariat, Platinum, XL, XLT; Pump only	<b>US78</b>	6.4L V8 391 CID	2008-2010	Medium/Heavy Duty, XLT	<b>US77</b>
6.7L V8 6651cc 406 CID	2017	King Ranch, Lariat, Platinum, XL, XLT	<b>US8157</b>	6.4L V8 391 CID	2008-2010	Medium/Heavy Duty, XLT	<b>US77</b>
6.7L V8 6651cc 406 CID	2018	King Ranch, Lariat, Limited, Platinum, XL, XLT	<b>US8157</b>	6.4L V8 391 CID	2008-2010	Medium/Heavy Duty, XLT	<b>US77</b>
6.8L V10 415 CID	1999-2003	Lariat, XL, XLT	<b>US4109</b>	6.4L V8 391 CID	2008-2010	Medium/Heavy Duty, XLT	<b>US77</b>
6.8L V10 415 CID	2004-2005	Harley-Davidson Edition, King Ranch, Lariat, XL, XLT	<b>US4109</b>	6.4L V8 391 CID	2008-2010	Medium/Heavy Duty, XLT	<b>US77</b>
6.8L V10 415 CID	2006-2007	King Ranch, Lariat, XL, XLT	<b>US4109</b>	6.4L V8 391 CID	2008-2010	Medium/Heavy Duty, XLT	<b>US77</b>
6.8L V10 415 CID	2008	FX4, Harley-Davidson Edition, King Ranch, Lariat, XL, XLT	<b>US4109</b>	6.4L V8 391 CID	2008-2010	Medium/Heavy Duty, XLT	<b>US77</b>
6.8L V10 415 CID	2009	Cabela's, FX4, Harley-Davidson Edition, King Ranch, Lariat, XL, XLT	<b>US4109</b>	6.4L V8 391 CID	2008-2010	Medium/Heavy Duty, XLT	<b>US77</b>
6.8L V10 415 CID	2010	Cabela's, King Ranch, Lariat, XL, XLT	<b>US6144</b>	6.4L V8 391 CID	2008-2010	Medium/Heavy Duty, XLT	<b>US77</b>
7.3L V8 445 CID	1999-2003	Lariat, XL, XLT	<b>US4114</b>	6.4L V8 391 CID	2008-2010	Medium/Heavy Duty, XLT	<b>US77</b>
<b>F-350 XL</b>				<b>F-550 SUPER DUTY</b>			
6.2L V8 6200cc 378 CID	2011-2014	Mexican Application	<b>US6006</b>	6.4L V8 391 CID	2008-2010	Lariat, Medium/Heavy Duty	<b>US76</b>
<b>F-350 XLT</b>				6.4L V8 391 CID	2008-2010	Medium/Heavy Duty, XL	<b>US76</b>
6.2L V8 6200cc 378 CID	2011-2014	Mexican Application	<b>US6006</b>	6.4L V8 391 CID	2008-2010	Medium/Heavy Duty, XLT	<b>US76</b>
<b>F-450</b>				6.4L V8 391 CID	2008-2010	Electric Water Pump, Lariat, Medium/Heavy Duty	<b>US11006</b>
6.7L V8 6700cc 409 CID	2013-2014	Mexican Application	<b>US77</b>	6.4L V8 391 CID	2008-2010	Electric Water Pump, Medium/Heavy Duty, XL	<b>US11006</b>
6.8L V10 6751cc 412 CID	2014	Mexican Application	<b>US4109</b>	6.4L V8 391 CID	2008-2010	Electric Water Pump, Medium/Heavy Duty, XLT	<b>US11006</b>
<b>F-450 SUPER DUTY</b>				6.4L V8 391 CID	2008-2010	Lariat, XL, XLT	<b>US11006</b>
6.4L V8 391 CID	2008	King Ranch, Medium/Heavy Duty	<b>US76</b>	6.4L V8 391 CID	2008-2010	XL	<b>US11006</b>
6.4L V8 391 CID	2008	Lariat, Medium/Heavy Duty	<b>US76</b>	6.4L V8 391 CID	2008-2010	Medium/Heavy Duty, XL	<b>US77</b>
6.4L V8 391 CID	2008	Medium/Heavy Duty, XLT	<b>US76</b>	6.4L V8 391 CID	2008-2010	Medium/Heavy Duty, XLT	<b>US77</b>
6.4L V8 391 CID	2008	King Ranch, Lariat, XL, XLT	<b>US11006</b>	6.4L V8 391 CID	2008-2010	Medium/Heavy Duty, XLT	<b>US77</b>
6.4L V8 391 CID	2008-2010	Medium/Heavy Duty, XL	<b>US76</b>	6.4L V8 391 CID	2008-2010	Medium/Heavy Duty, XLT	<b>US77</b>
6.4L V8 391 CID	2008-2010	Electric Water Pump, King Ranch, Medium/Heavy Duty	<b>US11006</b>	6.4L V8 391 CID	2008-2010	Medium/Heavy Duty, XLT	<b>US77</b>



Engine	Years	Application Description	USMW	Engine	Years	Application Description	USMW
<b>FORD (cont'd.)</b>				<b>FORD (cont'd.)</b>			
<b>F-550 SUPER DUTY (cont'd.)</b>				<b>FIESTA</b>			
6L V8 363 CID	2004	Medium/Heavy Duty, To 09/22/2003, XL	US61	1.0L L3 999cc 61 CID	2014-2017	SE	US8146
6L V8 363 CID	2004	Medium/Heavy Duty, To 09/22/2003, XLT	US61	1.3L L4 1299cc 79 CID	1998-2000		US8934
6L V8 363 CID	2004	From 09/22/03, Lariat, Medium/Heavy Duty	US67	1.4L L4 1388cc 85 CID	1998-2000	Mexican Application	US4104
6L V8 363 CID	2004	From 09/22/03, Medium/Heavy Duty, XL	US67	1.6L L4 1596cc 97 CID	2001		US8931
6L V8 363 CID	2004	From 09/22/03, Medium/Heavy Duty, XLT	US67	1.6L L4 1596cc 97 CID	2003-2009		US8931
6L V8 363 CID	2005-2007	Lariat, Medium/Heavy Duty	US67	1.6L L4 1596cc 97 CID	2010	First, Trend Comfort	US8931
6L V8 363 CID	2005-2007	Medium/Heavy Duty, XL	US67	1.6L L4 1596cc 97 CID	2011-2012	S, SE, SEL, SES	US9449
6L V8 363 CID	2005-2007	Medium/Heavy Duty, XLT	US67	1.6L L4 1596cc 97 CID	2013	S, SE, Titanium	US9449
7.3L V8 445 CID	1999-2003	Lariat, Medium/Heavy Duty	US4114	1.6L L4 1596cc 97 CID	2014-2018	S, SE, ST, Titanium	US9449
7.3L V8 445 CID	1999-2003	Medium/Heavy Duty, XL	US4114	1.6L L4 1598cc 98 CID	1978-1979		US4003
7.3L V8 445 CID	1999-2003	Medium/Heavy Duty, XLT	US4114	1.6L L4 1598cc 98 CID	1980	Base	US4003
<b>FAIRLANE</b>				<b>FIESTA IKON</b>			
2.8L L6 2786cc 170 CID	1962-1966		US1044	1.6L L4 1596cc 97 CID	2002-2004		US8931
3.3L L6 200 CID	1965-1969		US1044	1.6L L4 1598cc 98 CID	2011		US8931
3.3L L6 3277cc 200 CID	1963-1969		US1044	1.6L L4 1598cc 98 CID	2012	First	US8931
3.3L L6 3278cc 200 CID	1968-1969		US1044	1.6L L4 1600cc 98 CID	2012-2015	Ambiente, Trend	US8931
3.6L L6 3655cc 223 CID	1962		US819	<b>FIVE HUNDRED</b>			
3.6L V8 221 CID	1962-1963		US819	3.0L V6 2968cc 181 CID	2005-2006	Limited, SE, SEL	US6186
3.6L V8 3622cc 221 CID	1962-1963		US819	3.0L V6 2968cc 181 CID	2007	Limited, SEL	US6186
4.3L V8 260 CID	1963-1964		US819	<b>FLEX</b>			
4.3L V8 4261cc 260 CID	1962-1964		US819	3.5L V6 3496cc 213 CID	2009-2010	Limited, SE, SEL	US6023
4.4L V8 4458cc 272 CID	1955-1957		US488	3.5L V6 3496cc 213 CID	2011	Limited, SEL, Titanium; Turbocharged	US8910
4.5L V8 272 CID	1957		US488	3.5L V6 3496cc 213 CID	2011	Limited, SEL, Titanium; Naturally Aspirated	US8980
4.7L V8 289 CID	1963-1967		US819	3.5L V6 3496cc 213 CID	2011	SE	US8980
4.7L V8 4727cc 289 CID	1963-1967		US819	3.5L V6 3496cc 213 CID	2012	Limited, SEL, Titanium; Naturally Aspirated; From 01/02/2012	US8910
4.8L V8 292 CID	1957-1961		US488	3.5L V6 3496cc 213 CID	2012	Limited, SEL, Titanium; Turbocharged; From 01/02/2012	US8910
5.8L V8 352 CID	1961-1964		US723	3.5L V6 3496cc 213 CID	2012	Limited, SEL, Titanium; Turbocharged; To 01/02/2012	US8910
5.8L V8 5769cc 352 CID	1961-1964		US723	3.5L V6 3496cc 213 CID	2012	SE; From 01/02/2012	US8910
6.4L V8 390 CID	1961-1964		US723	3.5L V6 3496cc 213 CID	2012	Limited, SEL, Titanium; Naturally Aspirated; To 01/02/2012	US8980
6.4L V8 6391cc 390 CID	1961-1964		US723	3.5L V6 3496cc 213 CID	2012	SE; To 01/02/2012	US8980
7.0L V8 6997cc 427 CID	1964		US723	3.5L V6 3496cc 213 CID	2013-2018	Limited, SE, SEL	US8910
<b>FAIRMONT</b>				<b>FOCUS</b>			
2.3L L4 140 CID	1978-1979		US4005	1.0L L3 999cc 61 CID	2015-2018	SE	US8146
2.3L L4 140 CID	1980	Base, Futura	US4005	2.0L L4 1989cc 121 CID	2000	Sony Limited Edition, ZTS, ZX3	US4115
2.3L L4 140 CID	1981	Base, Futura, S	US4005	2.0L L4 1989cc 121 CID	2000-2003	SE; (3)	US4115
2.3L L4 140 CID	1982	Base, Futura	US4005	2.0L L4 1989cc 121 CID	2000-2003	SE; (P)	US4123
2.3L L4 140 CID	1983	Futura, S	US4054	2.0L L4 1989cc 121 CID	2000-2004	LX	US4123
3.3L L6 200 CID	1978-1979		US4002	2.0L L4 1989cc 121 CID	2001	ZTS, ZX3	US4115
3.3L L6 200 CID	1980	Base, Futura	US4002	2.0L L4 1989cc 121 CID	2002-2003	SVT, ZTS, ZTW, ZX3, ZX5	US4115
3.3L L6 200 CID	1981	Base, Futura, S	US4002	2.0L L4 1989cc 121 CID	2004	SE, SVT, ZTS, ZX3, ZX5	US4115
3.3L L6 200 CID	1982	Base, Futura	US4002	2.0L L4 1989cc 121 CID	2007-2011		US4126
3.3L L6 200 CID	1983	Futura, S	US4002	2.0L L4 1999cc 122 CID	2005-2006	ZX3, ZX4, ZX5, ZXW	US4126
4.2L V8 255 CID	1980	Base, Futura; WINDSOR	US953	2.0L L4 1999cc 122 CID	2007-2008	S, SE, SES	US4126
4.2L V8 255 CID	1980	Base, Futura; High performance	US953H	2.0L L4 1999cc 122 CID	2009-2011	S, SE, SEL, SES	US4126
4.2L V8 255 CID	1981	Base, Futura, S; WINDSOR	US953	2.0L L4 1999cc 122 CID	2012	S, SE, SEL, Titanium	US4126
4.2L V8 255 CID	1981	Base, Futura, S; High performance	US953H	2.0L L4 1999cc 122 CID	2013-2016	S, SE, ST, Titanium	US4126
4.2L V8 255 CID	1982	Base, Futura; WINDSOR	US953	2.0L L4 1999cc 122 CID	2017-2018	S, SE, SEL, ST, Titanium	US4126
4.2L V8 255 CID	1982	Base, Futura; High performance	US953H	2.3L L4 140 CID	2003-2004	LX, SE, ZTS, ZTW, ZX3, ZX5	US4126
4.2L V8 4200cc 256 CID	1978-1979	Mexican Application	US953	2.3L L4 140 CID	2005-2006	ZX4 ST	US4126
5.0L V8 302 CID	1978-1979	WINDSOR	US953	2.3L L4 140 CID	2007	ST	US4126
5.0L V8 302 CID	1978-1979	High performance	US953H	2.3L L4 2300cc 140 CID	2016-2018	RS	US8117
5.0L V8 5000cc 302 CID	1981-1983	Mexican Application	US953	2.5L L5 2521cc 154 CID	2007-2011	Mexican Application	US9339
<b>FALCON</b>				<b>FORD 300</b>			
2.4L L6 144 CID	1962-1964		US1044	3.3L L6 3277cc 200 CID	1963		US1044
2.4L L6 2360cc 144 CID	1960-1964		US1044	4.3L V8 4261cc 260 CID	1963		US819
2.8L L6 170 CID	1962-1969		US1044	4.7L V8 4727cc 289 CID	1963		US819
2.8L L6 2786cc 170 CID	1960-1969		US1044	5.8L V8 5769cc 352 CID	1963		US723
3.3L L6 200 CID	1965-1970		US1044	6.4L V8 6391cc 390 CID	1963		US723
3.3L L6 3277cc 200 CID	1964-1970		US1044	6.6L V8 6654cc 406 CID	1963		US723
3.3L L6 3278cc 200 CID	1968-1970		US1044	7.0L V8 6997cc 427 CID	1963		US723
3.6L V8 3622cc 221 CID	1962-1963		US819	<b>FREESTAR</b>			
4.3L V8 260 CID	1963-1964		US819	3.9L V6 238 CID	2004	Base, S, SE, SES	US4102
4.3L V8 4261cc 260 CID	1962-1965		US819	3.9L V6 238 CID	2005	S, SE, SES	US4102
4.7L V8 289 CID	1964-1966		US819	3.9L V6 238 CID	2006-2007	Base, SE	US4102
4.7L V8 4727cc 289 CID	1964-1966		US819	4.2L V6 256 CID	2004-2007	Limited, SEL	US4102
5.0L V8 5000cc 302 CID	1969	Mexican Application	US1028	<b>FREESTYLE</b>			
<b>FALCON SEDAN DELIVERY</b>				<b>F SUPER DUTY</b>			
2.4L L6 2360cc 144 CID	1961-1964		US1044	7.3L V8 445 CID	1988-1989	Base, Medium/Heavy Duty	US4018
2.8L L6 2786cc 170 CID	1961-1965		US1044	7.3L V8 445 CID	1990-1992	Custom, Medium/Heavy Duty	US4018
3.3L L6 3277cc 200 CID	1964-1965		US1044	7.3L V8 445 CID	1993-1994	Medium/Heavy Duty, Naturally Aspirated, XL	US4018
4.3L V8 4261cc 260 CID	1962		US819	7.3L V8 445 CID	1994	Medium/Heavy Duty, Turbocharged, XL	US4018
4.7L V8 4727cc 289 CID	1965		US819	7.3L V8 445 CID	1995	Medium/Heavy Duty, XL	US4096
<b>FESTIVA</b>				7.3L V8 445 CID	1996	Medium/Heavy Duty, To Engine # 201680, XL	US4096
1.3L L4 1295cc	1988	L, LX; From 04/1987	US4049				
1.3L L4 1295cc	1988	L, LX; To 04/1987	US4049				
1.3L L4 1295cc	1989	L, LX	US4049				
1.3L L4 1295cc	1990	GL, L, L Plus, LX	US4049				
1.3L L4 1295cc	1991-1993	GL, L	US4049				

WATER PUMPS

Engine	Years	Application Description	USMW	Engine	Years	Application Description	USMW
<b>FORD (cont'd.)</b>				<b>FORD (cont'd.)</b>			
<b>F SUPER DUTY (cont'd.)</b>				<b>GRAND MARQUIS (cont'd.)</b>			
7.3L V8 445 CID	1996	From Engine # 201681, Medium/Heavy Duty, XL	US4114	4.6L V8 4608cc 281 CID	1998-2001	Mexican Application	US4113
7.3L V8 445 CID	1997	Base, Medium/Heavy Duty	US4114	4.6L V8 4608cc 281 CID	2002-2004	Mexican Application	US4128
7.3L V8 445 CID	1997	Medium/Heavy Duty, XL	US4114	5.0L V8 5000cc 302 CID	1991-1992	Mexican Application	US4052
7.5L V8 460 CID	1990-1991	Custom, Medium/Heavy Duty	US1114	<b>GT</b>			
7.5L V8 460 CID	1992	Custom, Medium/Heavy Duty, To 02/03/1992	US1114	5.4L V8 5409cc 330 CID	2005-2006	Base	US8125
7.5L V8 460 CID	1992	Custom, From 02/03/1992, Medium/Heavy Duty	US4077	<b>GT40</b>			
7.5L V8 460 CID	1993-1994	Medium/Heavy Duty, XL	US4077	4.7L V8 289 CID	1968		US819
7.5L V8 460 CID	1995-1997	Medium/Heavy Duty, XL	US4086	4.7L V8 4727cc 289 CID	1966-1968		US819
7.5L V8 460 CID	1997	Base, Medium/Heavy Duty	US4086	7.0L V8 6997cc 427 CID	1964		US723
<b>FT800</b>				<b>KA</b>			
6.1L V8 370 CID	1980-1986		US4037	1.6L L4 1596cc 97 CID	2001-2008		US8931
6.1L V8 370 CID	1988-1990		US4037	<b>L800</b>			
7.0L V8 429 CID	1980-1986		US4037	6.1L V8 370 CID	1980-1985		US4037
7.0L V8 429 CID	1988-1990		US4037	7.0L V8 429 CID	1980-1985		US4037
<b>FUSION</b>				<b>LN600</b>			
1.5L L4 1499cc 91 CID	2014-2018	SE	US8107	6.1L V8 370 CID	1980-1985		US4037
1.6L L4 1596cc 97 CID	2013-2014	SE	US9449	<b>LN700</b>			
2.0L L4 1999cc 122 CID	2013-2016	SE, Titanium	US4126	6.1L V8 370 CID	1980-1985		US4037
2.0L L4 1999cc 122 CID	2017-2018	Platinum, SE, Titanium	US8975	7.0L V8 429 CID	1980-1985		US4037
2.3L L4 140 CID	2006-2009	S, SE, SEL	US4126	<b>LN800</b>			
2.5L L4 2488cc 152 CID	2010-2012	Hybrid, S, SE, SEL	US4126	6.1L V8 370 CID	1980-1985		US4037
2.5L L4 2488cc 152 CID	2013-2018	S, SE	US4126	7.0L V8 429 CID	1980-1985		US4037
2.7L V6 164 CID	2017	Sport	US8141	<b>LN7000</b>			
2.7L V6 164 CID	2017	Sport; 3 Bolt Pulley	US8141P	5.9L L6 359 CID	1993-1997		US7145N
2.7L V6 164 CID	2017	Sport; Includes 3 hole pulley	US8141P-T	6.6L L6 401 CID	1987-1990		US4062
2.7L V6 164 CID	2017	Sport; Includes 3 hole pulley and thermostat / housing	US8141P-T	7.8L L6 473 CID	1987-1988		US4062
2.7L V6 164 CID	2017	Sport; 3 Bolt hub Includes thermostat / housing	US8141P	<b>LN8000</b>			
2.7L V6 164 CID	2017-2018	Sport	US8141P	7.8L L6 473 CID	1987-1990		US4062
3.0L V6 2967cc 181 CID	2011-2012	Mexican Application	US6250	<b>LOBO</b>			
3.0L V6 2968cc 181 CID	2006-2009	SE, SEL	US9489	4.6L V8 4608cc 281 CID	2007	Mexican Application	US4125
3.0L V6 2968cc 181 CID	2006-2009	SE, SEL; Includes back housing	US9489-2	5.0L V8 5000cc 305 CID	2011-2014	Mexican Application	US8963
3.0L V6 2968cc 181 CID	2010-2012	SE, SEL	US6250	5.4L V8 5409cc 330 CID	1999-2010	Mexican Application	US4125
3.0L V6 3000cc 183 CID	2010	Mexican Application	US6250	6.2L V8 6200cc 378 CID	2011-2014	Mexican Application	US6006
3.5L V6 3496cc 213 CID	2010-2011	Sport	US6023	<b>LTD</b>			
3.5L V6 3496cc 213 CID	2012	Sport; From 01/02/2012	US8910	2.3L L4 140 CID	1983-1986	Base, Brougham	US4054
3.5L V6 3496cc 213 CID	2012	Sport; To 01/02/2012	US8980	3.3L L6 200 CID	1983	Base, Brougham	US4002
<b>GALAXIE</b>				3.8L V6 232 CID	1983-1986	Base, Brougham	US4016
3.3L L6 3277cc 200 CID	1963		US1044	4.2L V8 255 CID	1981-1982	Base, Crown Victoria, S	US4014
4.3L V8 4261cc 260 CID	1963-1964		US819	4.2L V8 255 CID	1981-1982	Base, Crown Victoria, S; High performance	US4014H
4.7L V8 4727cc 289 CID	1963-1965		US819	4.7L V8 4727cc 289 CID	1965-1967		US819
4.8L V8 4786cc 292 CID	1959-1962		US488	5.0L V8 302 CID	1977-1979	WINDSOR	US953
5.8L V8 5769cc 352 CID	1961-1964		US723	5.0L V8 302 CID	1977-1979	High performance	US953H
5.8L V8 5800cc 351 CID	1969	Mexican Application	US1028	5.0L V8 302 CID	1980-1982	Base, Country Squire, Crown Victoria, S	US4014
5.8L V8 5800cc 351 CID	1970-1976	Mexican Application	US953	5.0L V8 302 CID	1980-1982	Base, Country Squire, Crown Victoria, S; High performance	US4014H
6.4L V8 6391cc 390 CID	1961-1964		US723	5.0L V8 302 CID	1983	Country Squire, Crown Victoria	US4014
6.6L V8 6654cc 406 CID	1962-1963		US723	5.0L V8 302 CID	1983	Country Squire, Crown Victoria; High performance	US4014H
7.0L V8 6997cc 427 CID	1963-1964		US723	5.0L V8 302 CID	1984	Base, Brougham, Country Squire, Crown Victoria	US4014
<b>GALAXIE 500</b>				5.0L V8 302 CID	1984	Base, Brougham, Country Squire, Crown Victoria	US4014H
3.3L L6 200 CID	1963		US1044	5.0L V8 302 CID	1985	Country Squire, Crown Victoria	US4014
4.3L V8 260 CID	1963-1964		US819	5.0L V8 302 CID	1985	Country Squire, Crown Victoria; High performance	US4014H
4.7L V8 289 CID	1963-1967		US819	5.0L V8 302 CID	1985	Base, Brougham, LX Brougham	US4024
5.8L V8 352 CID	1962-1964		US723	5.0L V8 302 CID	1985	Base, Brougham, LX Brougham; High performance	US4024H
6.4L V8 390 CID	1962-1964		US723	5.0L V8 302 CID	1986	Country Squire, Country Squire LX, Crown Victoria, Crown Victoria LX	US4014
<b>GHIA</b>				5.0L V8 302 CID	1986	Country Squire, Country Squire LX, Crown Victoria, Crown Victoria LX	US4014H
2.3L L4 2300cc 140 CID	1990	Mexican Application	US4022	5.0L V8 302 CID	1986	Country Squire, Country Squire LX, Crown Victoria, Crown Victoria LX; High performance	US4014H
2.3L L4 2300cc 140 CID	1991-1992	Mexican Application	US4041	5.0L V8 5000cc 302 CID	1975-1976	Mexican Application	US953
3.0L V6 2985cc 182 CID	1992-1994	Mexican Application	US4070	5.8L V8 351 CID	1975-1979	MODIFIED	US932
<b>GRANADA</b>				5.8L V8 351 CID	1975-1979	WINDSOR	US953
2.3L L4 140 CID	1981-1982	GL, GLX, L	US4005	5.8L V8 351 CID	1975-1979	High performance	US953H
3.3L L6 200 CID	1975	Air Cond	US1044	5.8L V8 351 CID	1980-1981	Base, Country Squire, Crown Victoria, S	US4014
3.3L L6 200 CID	1975	W/O AIR	US4002	5.8L V8 351 CID	1980-1981	Base, Country Squire, Crown Victoria, S; High performance	US4014H
3.3L L6 200 CID	1976-1977		US4002	5.8L V8 351 CID	1982	Base, Crown Victoria, S	US4014
3.3L L6 200 CID	1981-1982	GL, GLX, L	US4002	5.8L V8 351 CID	1982	Base, Crown Victoria, S; High performance	US4014H
3.8L V6 232 CID	1982	GL, GLX, L	US4016	5.8L V8 351 CID	1982	Base, Crown Victoria, S; High performance	US4014H
4.1L L6 250 CID	1975-1979		US960	5.8L V8 351 CID	1983-1985	Country Squire, Crown Victoria	US4014
4.1L L6 250 CID	1980	Base, ESS, Ghia	US960	5.8L V8 351 CID	1983-1985	Country Squire, Crown Victoria; High performance	US4014H
4.2L V8 255 CID	1980	Base, ESS, Ghia; WINDSOR	US953	5.8L V8 351 CID	1986	Country Squire, Country Squire LX, Crown Victoria, Crown Victoria LX	US4014
4.2L V8 255 CID	1980	Base, ESS, Ghia; High performance	US953H				
4.2L V8 255 CID	1981	GL, GLX, L; WINDSOR	US953				
4.2L V8 255 CID	1981	GL, GLX, L; High performance	US953H				
5.0L V8 302 CID	1975-1979	WINDSOR	US953				
5.0L V8 302 CID	1975-1979	High performance	US953H				
5.0L V8 302 CID	1980	Base, ESS, Ghia; WINDSOR	US953				
5.0L V8 302 CID	1980	Base, ESS, Ghia; High performance	US953H				
5.8L V8 351 CID	1975-1977	WINDSOR	US953				
5.8L V8 351 CID	1975-1977	High performance	US953H				
<b>GRAND MARQUIS</b>							
4.6L V8 4608cc 281 CID	1992-1997	Mexican Application	US4066				

Engine	Years	Application Description	USMW	Engine	Years	Application Description	USMW
<b>FORD (cont'd.)</b>				<b>FORD (cont'd.)</b>			
<b>LTD (cont'd.)</b>				<b>MUSTANG (cont'd.)</b>			
5.8L V8 351 CID	1986	Country Squire, Country Squire LX, Crown Victoria, Crown Victoria LX; High performance	US4014H	3.7L V6 3726cc 227 CID	2015	V6; Serpentine Belt Driven	US6654
5.8L V8 5752cc 351 CID	1978	WINDSOR	US953	3.7L V6 3726cc 227 CID	2016-2017	V6	US8916
5.8L V8 5800cc 351 CID	1977-1978	Mexican Application	US953	3.8L V6 232 CID	1983	GL, GLX, L	US4016
5.8L V8 5800cc 351 CID	1979-1980	Mexican Application	US4052	3.8L V6 232 CID	1984	L, LX	US4016
6.6L V8 400 CID	1975-1978	MODIFIED	US932	3.8L V6 232 CID	1985-1986	LX	US4016
7.5L V8 460 CID	1975-1978		US1114	3.8L V6 232 CID	1994-1995	Base	US4090
<b>LTD CROWN VICTORIA</b>				3.8L V6 232 CID	1996-2004	Base	US4103
5.0L V8 302 CID	1987	Base, LX, S	US4014	3.9L V6 238 CID	2004	Base	US4103
5.0L V8 302 CID	1987	Base, LX, S; High performance	US4014H	4.0L V6 245 CID	2005-2010	Base	US4108
5.0L V8 302 CID	1988	Base, LX, S; To 06/1988	US4014	4.2L V8 255 CID	1980	Base, Ghia	US4024
5.0L V8 302 CID	1988	Base, LX, S; High performance, To 06/88	US4014H	4.2L V8 255 CID	1980	Base, Ghia; High performance	US4024H
5.0L V8 302 CID	1988	Base, LX, S; From 06/1988	US4052	4.2L V8 255 CID	1981	Base, Cobra, Ghia	US4024
5.0L V8 302 CID	1988	Base, LX, S; From 06/88, High performance	US4052H	4.2L V8 255 CID	1981	Base, Cobra, Ghia; High performance	US4024H
5.0L V8 302 CID	1989-1991	Base, LX, S	US4052	4.2L V8 255 CID	1982	GL, GLX, L	US4024
5.0L V8 302 CID	1989-1991	Base, LX, S; High performance	US4052H	4.2L V8 255 CID	1982	GL, GLX, L; High performance	US4024H
5.8L V8 351 CID	1987-1991	Base	US4014	4.3L V8 4261cc 260 CID	1964-1965		US819
5.8L V8 351 CID	1987-1991	Base; High performance	US4014H	4.6L V8 281 CID	1996-1998	GT, SVT Cobra; Pump Length: long	US4113
<b>LTD II</b>				4.6L V8 281 CID	1999	GT, SVT Cobra	US4119
5.0L V8 302 CID	1977-1979	WINDSOR	US953	4.6L V8 281 CID	2000	GT	US4119
5.0L V8 302 CID	1977-1979	High performance	US953H	4.6L V8 281 CID	2001	GT, GT Bullitt; 87mm From Pulley Surface To Mounting Surface	US4119
5.8L V8 351 CID	1977-1979	MODIFIED	US932	4.6L V8 281 CID	2001	SVT Cobra	US4119
5.8L V8 351 CID	1977-1979	WINDSOR	US953	4.6L V8 281 CID	2001	GT, GT Bullitt; 65mm From Pulley Surface To Mounting Surface	US4128
5.8L V8 351 CID	1977-1979	High performance	US953H	4.6L V8 281 CID	2002	GT; 65mm From Pulley Surface To Mounting Surface	US4128
6.6L V8 400 CID	1977-1978	MODIFIED	US932	4.6L V8 281 CID	2002-2004	GT; 87mm From Pulley Surface To Mounting Surface	US4119
<b>MAINLINE</b>				4.6L V8 281 CID	2003	GT, SVT Cobra 10th Anniversary; 65mm From Pulley Surface To Mounting Surface	US4128
3.9L V8 3917cc 239 CID	1954		US488	4.6L V8 281 CID	2003	SVT Cobra, SVT Cobra 10th Anniversary	US11014
4.4L V8 4458cc 272 CID	1955-1956		US488	4.6L V8 281 CID	2003-2004	Mach I	US4119
<b>MAVERICK</b>				4.6L V8 281 CID	2003-2004	SVT Cobra	US4128
2.8L L6 170 CID	1970-1972		US1044	4.6L V8 281 CID	2004	GT; 65mm From Pulley Surface To Mounting Surface	US4128
2.8L L6 2786cc 170 CID	1970-1972		US1044	4.6L V8 281 CID	2004	SVT Cobra	US11014
3.3L L6 200 CID	1970-1974		US1044	4.6L V8 281 CID	2005-2006	GT; Pump Length: long	US4113
3.3L L6 200 CID	1975	W/O AIR	US1044	4.6L V8 281 CID	2007	GT, Shelby GT	US4119
3.3L L6 200 CID	1975	Air Cond	US4002	4.6L V8 281 CID	2008	Bullitt, GT, Shelby GT	US4119
3.3L L6 200 CID	1976-1977		US4002	4.6L V8 281 CID	2009	Bullitt, GT	US4119
3.3L L6 3277cc 200 CID	1970-1974		US1044	4.6L V8 281 CID	2010		US4119
3.3L L6 3278cc 200 CID	1970-1974		US1044	4.7L V8 289 CID	1968		US819
4.1L L6 250 CID	1975-1977		US960	4.7L V8 4727cc 289 CID	1964-1968		US819
4.7L V8 4700cc 289 CID	1971-1977	Mexican Application	US953	5.0L V8 302 CID	1979		US4024
5.0L V8 302 CID	1975-1977	WINDSOR	US953	5.0L V8 302 CID	1979	High performance	US4024H
5.0L V8 302 CID	1975-1977	High performance	US953H	5.0L V8 302 CID	1982	GL, GLX, GT, L	US4024
5.0L V8 5000cc 302 CID	1970	Mexican Application	US953	5.0L V8 302 CID	1982	GL, GLX, GT, L; High performance	US4024H
<b>MONDEO</b>				5.0L V8 302 CID	1983	GT	US4024
2.0L L4 1999cc 122 CID	2001-2007		US4126	5.0L V8 302 CID	1983	GT; High performance	US4024H
2.5L V6 2544cc 155 CID	2001-2007	Mexican Application	US4091	5.0L V8 302 CID	1984	GT, GT-350 20th Anniversary, L, LX	US4024
3.0L V6 2966cc 181 CID	2005	Mexican Application	US4091	5.0L V8 302 CID	1984	GT, GT-350 20th Anniversary, L, LX; Exc.CFI, High performance	US4024H
<b>MUSTANG</b>				5.0L V8 302 CID	1984	GT, GT-350 20th Anniversary, L, LX	US4035
2.3L L4 140 CID	1979		US4005	5.0L V8 302 CID	1985	GT, LX	US4024
2.3L L4 140 CID	1980-1981	Base, Ghia	US4005	5.0L V8 302 CID	1985	GT, LX; High performance	US4024H
2.3L L4 140 CID	1982	GL, GLX, L	US4005	5.0L V8 302 CID	1985	GT	US4035
2.3L L4 140 CID	1983	GL, GLX, L, Turbo GT	US4054	5.0L V8 302 CID	1986-1992	GT, LX	US4038
2.3L L4 140 CID	1984	GT, GT-350 20th Anniversary, L, LX, SVO	US4054	5.0L V8 302 CID	1986-1992	GT, LX; High performance	US4038H
2.3L L4 140 CID	1985-1986	LX, SVO	US4054	5.0L V8 302 CID	1993	GT, LX, SVT Cobra	US4038
2.3L L4 140 CID	1987	LX	US4054	5.0L V8 302 CID	1993	GT, LX, SVT Cobra, SVT Cobra R; High performance	US4038H
2.3L L4 140 CID	1988	LX; From 12/1987	US4054	5.0L V8 302 CID	1994	GT, SVT Cobra	US4087
2.3L L4 140 CID	1988	LX; To 12/1987	US4054	5.0L V8 302 CID	1995	GT, GTS, SVT Cobra	US4087
2.3L L4 140 CID	1989-1993	LX	US4054	5.0L V8 4951cc 302 CID	2011	GT	US8963
2.3L L4 2300cc 140 CID	2015	EcoBoost, EcoBoost Premium	US8117	5.0L V8 4951cc 302 CID	2012-2013	Boss 302, GT	US8963
2.3L L4 2300cc 140 CID	2015-2016	EcoBoost, EcoBoost Premium; Engine # FX-195/6-AA (Engine # FV795/6-AA)	US8117	5.0L V8 4951cc 302 CID	2014	GT	US8963
2.3L L4 2300cc 140 CID	2015-2016	EcoBoost, EcoBoost Premium; Engine # FC-765-6-AA (Engine # FC-793/4-AA)	US8975	5.0L V8 4951cc 302 CID	2015	GT, GT 50 Years Limited Edition, GT Premium	US8116
2.3L L4 2300cc 140 CID	2016	EcoBoost, EcoBoost Premium; From 01/09/2016	US8975	5.0L V8 4951cc 302 CID	2016-2018	GT, GT Premium	US8116
2.3L L4 2300cc 140 CID	2016	EcoBoost, EcoBoost Premium; To 01/09/2016	US8975	5.0L V8 5000cc 302 CID	1969	Mexican Application	US1028
2.3L L4 2300cc 140 CID	2016-2018	EcoBoost, EcoBoost Premium	US8975	5.0L V8 5000cc 302 CID	1973-1974	Mexican Application	US953
2.8L L6 2786cc 170 CID	1964-1965		US1044	5.0L V8 5000cc 302 CID	1974	Mexican Application	US4024
2.8L V6 171 CID	1979		US1047	5.0L V8 5000cc 302 CID	1975	Mexican Application	US1070
3.3L L6 200 CID	1968-1970		US1044	5.0L V8 5000cc 302 CID	1976-1978	Mexican Application	US953
3.3L L6 200 CID	1979		US4002	5.0L V8 5000cc 302 CID	1979-1981	Mexican Application	US4024
3.3L L6 200 CID	1980-1981	Base, Ghia	US4002	5.0L V8 5000cc 302 CID	1983-1984	Mexican Application	US4024
3.3L L6 200 CID	1982	GL, GLX, L	US4002	5.2L V8 5163cc 315 CID	2015-2018	Shelby GT350, Shelby GT350R	US8116
3.3L L6 3277cc 200 CID	1964-1970		US1044	5.4L V8 5409cc 330 CID	2007	Shelby GT500	US8125
3.3L L6 3278cc 200 CID	1968-1970		US1044	5.4L V8 5409cc 330 CID	2008-2009	Shelby GT500, Shelby GT500KR	US8125
3.7L V6 3700cc 227 CID	2012	Mexican Application	US6654	5.4L V8 5409cc 330 CID	2010-2012	Shelby GT500	US8125
3.7L V6 3700cc 227 CID	2014	Mexican Application	US6654	5.8L V8 5800cc 351 CID	1974	Mexican Application	US953
3.7L V6 3726cc 227 CID	2011-2014	Base; Serpentine Belt Driven	US6654	5.8L V8 5812cc 355 CID	2013-2014	Shelby GT500	US8125
3.7L V6 3726cc 227 CID	2014	Base	US6654	<b>MUSTANG II</b>			
3.7L V6 3726cc 227 CID	2015	V6	US6654	2.3L L4 140 CID	1975-1978		US4005
				2.8L V6 171 CID	1975-1978		US1047
				5.0L V8 302 CID	1975		US1070

WATER PUMPS



Engine	Years	Application Description	USMW	Engine	Years	Application Description	USMW
<b>FORD (cont'd.)</b>				<b>FORD (cont'd.)</b>			
<b>MUSTANG II (cont'd.)</b>				<b>RANGER (cont'd.)</b>			
5.0L V8 302 CID	1976	From 03/15/76, WINDSOR	<b>US953</b>	2.3L L4 140 CID	1991-1992	Custom, S, Sport, XLT	<b>US4054</b>
5.0L V8 302 CID	1976	From 03/15/76, High performance	<b>US953H</b>	2.3L L4 140 CID	1993	Splash, Sport, STX, XL, XLT	<b>US4054</b>
5.0L V8 302 CID	1976	To 03/15/76	<b>US1070</b>	2.3L L4 140 CID	1994	Splash, STX, XL, XLT	<b>US4054</b>
5.0L V8 302 CID	1976-1978	WINDSOR	<b>US953</b>	2.3L L4 140 CID	1995	Splash, STX, XL, XL Sport, XLT	<b>US4093</b>
5.0L V8 302 CID	1977-1978	High performance	<b>US953H</b>	2.3L L4 140 CID	1996	Splash, XL, XLT	<b>US4093</b>
<b>MYSTIQUE</b>				2.3L L4 140 CID	1997	Splash, Sport, XL, XLT	<b>US4093</b>
2.0L L4 1984cc 121 CID	1994-1995	Mexican Application	<b>US4088</b>	2.3L L4 140 CID	2001-2006	XL, XLT	<b>US4126</b>
2.5L V6 2544cc 155 CID	1995-2000	Mexican Application	<b>US4091</b>	2.3L L4 140 CID	2007	STX, XL, XLT	<b>US4126</b>
<b>P350</b>				2.3L L4 140 CID	2008	XL, XLT	<b>US4126</b>
5.0L V8 5000cc 302 CID	1975	Mexican Application	<b>US953</b>	2.3L L4 140 CID	2009	Sport, XL, XLT	<b>US4126</b>
5.0L V8 5000cc 302 CID	1989-1991	Mexican Application	<b>US4044</b>	2.3L L4 140 CID	2010-2011	XL, XLT	<b>US4126</b>
5.8L V8 5800cc 351 CID	1986-1987	Mexican Application	<b>US953</b>	2.5L L4 153 CID	1998	Splash, XL, XLT	<b>US4093</b>
5.8L V8 5800cc 351 CID	1988-1997	Mexican Application	<b>US4044</b>	2.5L L4 153 CID	1999-2001	XL, XLT	<b>US4093</b>
<b>P400</b>				2.8L V6 171 CID	1983	Base, XL, XLS, XLT	<b>US4023</b>
5.0L V8 5000cc 302 CID	1975	Mexican Application	<b>US953</b>	2.8L V6 171 CID	1984	S, XL, XLS, XLT	<b>US4023</b>
<b>P-100</b>				2.8L V6 171 CID	1985	Base, XL, XLS, XLT	<b>US4023</b>
2.4L L6 2360cc 144 CID	1960-1964		<b>US1044</b>	2.9L V6 177 CID	1986	Base, STX, XL, XLT	<b>US4042</b>
2.8L L6 2786cc 170 CID	1961-1970		<b>US1044</b>	2.9L V6 177 CID	1987-1988	Custom, STX, XLT	<b>US4042</b>
<b>P-350</b>				2.9L V6 177 CID	1989	Custom, GT, STX, XLT	<b>US4042</b>
2.8L L6 2786cc 170 CID	1961-1967		<b>US1044</b>	2.9L V6 177 CID	1990	Custom, STX, XLT	<b>US4042</b>
2.8L L6 2786cc 170 CID	1970		<b>US1044</b>	2.9L V6 177 CID	1991-1992	Custom, Sport, STX, XLT	<b>US4042</b>
<b>PINTO</b>				3.0L V6 2986cc 182 CID	1991-1992	Custom, S, Sport, STX, XLT	<b>US4039</b>
2.0L L4 1993cc 122 CID	1971-1974		<b>US964</b>	3.0L V6 2986cc 182 CID	1993	Splash, Sport, STX, XL, XLT	<b>US4039</b>
2.3L L4 140 CID	1975-1979		<b>US4005</b>	3.0L V6 2986cc 182 CID	1994	Splash, STX, XL, XLT	<b>US4039</b>
2.3L L4 140 CID	1980	Base, Pony, Squire	<b>US4005</b>	3.0L V6 2986cc 182 CID	1995	Splash, STX, XL, XL Sport, XLT	<b>US4095</b>
2.8L V6 171 CID	1975-1979		<b>US1047</b>	3.0L V6 2986cc 182 CID	1996	Splash, STX, XL, XLT; 28mm From Base To End Of Nipple	<b>US4095</b>
<b>POLICE INTERCEPTOR SEDAN</b>				3.0L V6 2986cc 182 CID	1996	Splash, STX, XL, XLT; 42.71mm From Base To End Of Nipple	<b>US4095</b>
3.5L V6 3496cc 213 CID	2013-2018	Base	<b>US8910</b>	3.0L V6 2986cc 182 CID	1997	Splash, Sport, STX, XL, XLT; 28mm From Base To End Of Nipple	<b>US4095</b>
3.7L V6 3726cc 227 CID	2013-2018	Base	<b>US8910</b>	3.0L V6 2986cc 182 CID	1997	Splash, Sport, STX, XL, XLT; 42.71mm From Base To End Of Nipple	<b>US4095</b>
<b>POLICE INTERCEPTOR UTILITY</b>				3.0L V6 2986cc 182 CID	1998	Splash, XL, XLT	<b>US4095</b>
3.5L V6 3496cc 213 CID	2014-2018	Base	<b>US8910</b>	3.0L V6 2986cc 182 CID	1999-2000	XL, XLT	<b>US4095</b>
3.7L V6 3726cc 227 CID	2013-2018	Base	<b>US8910</b>	3.0L V6 2986cc 182 CID	2001-2003	Edge, XL, XLT	<b>US4095</b>
<b>PROBE</b>				3.0L V6 2986cc 182 CID	2004	Edge, Tremor, XL, XLT	<b>US4095</b>
2.0L L4 1989cc 122 CID	1993-1996	Base, SE	<b>US4078</b>	3.0L V6 2986cc 182 CID	2005	Edge, STX, XL, XLT	<b>US4095</b>
2.0L L4 1989cc 122 CID	1997	Base, GTS	<b>US4078</b>	3.0L V6 2986cc 182 CID	2006	Sport, STX, XL, XLT; From 08/08/05	<b>US4095</b>
2.2L L4 133 CID	1989	GL, GT, LX	<b>US4053</b>	3.0L V6 2986cc 182 CID	2006	Sport, STX, XL, XLT; To 08/08/05	<b>US4095</b>
2.2L L4 133 CID	1990	GL, GT	<b>US4053</b>	3.0L V6 2986cc 182 CID	2007	Sport, STX, XL, XLT	<b>US4095</b>
2.2L L4 133 CID	1991-1992	Base, GL, GT	<b>US4053</b>	3.0L V6 2986cc 182 CID	2008	Sport, XL, XLT	<b>US4095</b>
2.5L V6 2497cc	1993-1994	GT	<b>US9259</b>	4.0L V6 245 CID	1990	Custom, S, S Plus, STX, XLT	<b>US4060</b>
2.5L V6 2497cc	1995-1997	GT	<b>US9318</b>	4.0L V6 245 CID	1991-1992	Custom, S, Sport, STX, XLT	<b>US4060</b>
3.0L V6 2986cc 182 CID	1990	LX	<b>US4059</b>	4.0L V6 245 CID	1993	Splash, Sport, STX, XL, XLT	<b>US4060</b>
3.0L V6 2986cc 182 CID	1991-1992	LX, SE	<b>US4059</b>	4.0L V6 245 CID	1994	Splash, STX, XL, XLT	<b>US4060</b>
<b>RANCHERO</b>				4.0L V6 245 CID	1995	Splash, STX, XL, XL Sport, XLT	<b>US4060</b>
2.4L L6 2360cc 144 CID	1960-1964		<b>US1044</b>	4.0L V6 245 CID	1996	Splash, STX, XL, XLT	<b>US4060</b>
2.8L L6 2786cc 170 CID	1961-1965		<b>US1044</b>	4.0L V6 245 CID	1997	Splash, Sport, STX, XLT	<b>US4060</b>
3.3L L6 200 CID	1966-1968		<b>US1044</b>	4.0L V6 245 CID	1998	Splash, XL, XLT	<b>US4060</b>
3.3L L6 3277cc 200 CID	1964-1968		<b>US1044</b>	4.0L V6 245 CID	1999-2000	XL, XLT	<b>US4060</b>
3.3L L6 3278cc 200 CID	1968		<b>US1044</b>	4.0L V6 245 CID	2001-2003	Edge, XL, XLT	<b>US4108</b>
4.4L V8 4458cc 272 CID	1957		<b>US488</b>	4.0L V6 245 CID	2004	Edge, Tremor, XLT	<b>US4108</b>
4.8L V8 4786cc 292 CID	1957-1959		<b>US488</b>	4.0L V6 245 CID	2005	Edge, FX4, XL, XLT	<b>US4108</b>
5.0L V8 302 CID	1977-1979	WINDSOR	<b>US953</b>	4.0L V6 245 CID	2006-2007	FX4, Sport, STX, XL, XLT	<b>US4108</b>
5.0L V8 302 CID	1977-1979	High performance	<b>US953H</b>	4.0L V6 245 CID	2008-2009	FX4, Sport, XL, XLT	<b>US4108</b>
5.8L V8 351 CID	1975	WINDSOR	<b>US953</b>	4.0L V6 245 CID	2010-2011	Sport, XL, XLT	<b>US4108</b>
5.8L V8 351 CID	1975-1979	MODIFIED	<b>US932</b>	<b>SABLE</b>			
5.8L V8 351 CID	1975-1979	High performance	<b>US953H</b>	3.0L V6 2966cc 181 CID	1998-2002	Mexican Application	<b>US4094</b>
5.8L V8 351 CID	1977-1978	WINDSOR	<b>US953</b>	3.0L V6 3000cc 183 CID	1996-1997	Mexican Application	<b>US4094</b>
6.6L V8 400 CID	1975-1978	MODIFIED	<b>US932</b>	3.8L V6 3800cc 232 CID	1994-1995	Mexican Application	<b>US4089</b>
7.5L V8 460 CID	1975-1977		<b>US1114</b>	<b>SPECIAL SERVICE POLICE SEDAN</b>			
<b>RANCH WAGON</b>				2.0L L4 1999cc 122 CID	2014-2018	Base	<b>US4126</b>
2.4L L6 2360cc 144 CID	1960-1961		<b>US1044</b>	<b>SPRINT</b>			
2.4L L6 2360cc 144 CID	1964		<b>US1044</b>	2.8L L6 2786cc 170 CID	1963-1964		<b>US1044</b>
2.8L L6 2786cc 170 CID	1960-1969		<b>US1044</b>	3.3L L6 3277cc 200 CID	1963-1964		<b>US1044</b>
3.3L L6 3277cc 200 CID	1963-1970		<b>US1044</b>	<b>STATION BUS</b>			
5.8L V8 5769cc 352 CID	1961-1964		<b>US723</b>	2.4L L6 144 CID	1962-1964		<b>US1044</b>
6.4L V8 6391cc 390 CID	1961-1964		<b>US723</b>	2.8L L6 170 CID	1965		<b>US1044</b>
6.6L V8 6654cc 406 CID	1962-1963		<b>US723</b>	<b>TAURUS</b>			
7.0L V8 6997cc 427 CID	1963-1964		<b>US723</b>	2.0L L4 1999cc 122 CID	2013-2017	Limited, SE, SEL	<b>US4126</b>
<b>RANGER</b>				2.5L L4 153 CID	1986-1988	GL, L, MT5	<b>US4056</b>
2.0L L4 1989cc 122 CID	1983	Base, XL, XLS, XLT	<b>US4054</b>	2.5L L4 153 CID	1989-1990	GL, L	<b>US4056</b>
2.0L L4 1989cc 122 CID	1984	S, XL, XLS, XLT	<b>US4054</b>	2.5L L4 153 CID	1991	GL	<b>US4056</b>
2.0L L4 1989cc 122 CID	1985	Base, XL, XLS, XLT	<b>US4054</b>	3.0L V6 2968cc 181 CID	1996-1997	LX	<b>US4098</b>
2.0L L4 1989cc 122 CID	1986-1988	S	<b>US4054</b>	3.0L V6 2968cc 181 CID	1998	LX, SE Comfort	<b>US4098</b>
2.3L L4 140 CID	1983	Base, XL, XLS, XLT	<b>US4054</b>	3.0L V6 2968cc 181 CID	1999	LX, SE	<b>US4098</b>
2.3L L4 140 CID	1984	S, XL, XLS, XLT	<b>US4054</b>	3.0L V6 2968cc 181 CID	2000	SE, SE Comfort, SEL, SVG	<b>US4098</b>
2.3L L4 140 CID	1985	Base, XL, XLS, XLT	<b>US4054</b>	3.0L V6 2968cc 181 CID	2001-2002	SE, SEL	<b>US4091</b>
2.3L L4 140 CID	1986	Base, S, STX, XL, XLT	<b>US4054</b>	3.0L V6 2968cc 181 CID	2001-2002	SE, SEL; Includes back housing	<b>US4091-2</b>
2.3L L4 140 CID	1987	Custom, STX, XLT	<b>US4054</b>	3.0L V6 2968cc 181 CID	2003	SE, SE Comfort, SEL, SES; To 04/01/2003	<b>US4091</b>
2.3L L4 140 CID	1988-1989	Custom, S, STX, XLT	<b>US4054</b>	3.0L V6 2968cc 181 CID	2003	SE, SE Comfort, SEL, SES; Includes back housing, To 04/01/2003	<b>US4091-2</b>
2.3L L4 140 CID	1990	Custom, S, S Plus, STX, XLT	<b>US4054</b>				

Engine	Years	Application Description	USMW	Engine	Years	Application Description	USMW
<b>FORD (cont'd.)</b>				<b>FORD (cont'd.)</b>			
<b>TAURUS (cont'd.)</b>				<b>THUNDERBIRD (cont'd.)</b>			
3.0L V6 2968cc 181 CID	2003	SE, SE Comfort, SEL, SES; From 04/01/2003	US4132	5.0L V8 302 CID	1981	Base, Heritage, Town Landau	US4014
3.0L V6 2968cc 181 CID	2003	SE, SE Comfort, SEL, SES; From 04/01/2003, Includes back housing	US4132-2	5.0L V8 302 CID	1981	Base, Heritage, Town Landau; High performance	US4014H
3.0L V6 2968cc 181 CID	2004	SE, SEL, SES	US4132	5.0L V8 302 CID	1983	Base, Heritage, LX, Sport	US4014
3.0L V6 2968cc 181 CID	2004	SE, SEL, SES; Includes back housing	US4132-2	5.0L V8 302 CID	1983	Base, Heritage, LX, Sport; High performance	US4014H
3.0L V6 2968cc 181 CID	2005	SE, SEL	US4132	5.0L V8 302 CID	1984-1985	Base, Elan, Fila, LX, Sport	US4014
3.0L V6 2968cc 181 CID	2005	SE, SEL; Includes back housing	US4132-2	5.0L V8 302 CID	1984-1985	Base, Elan, Fila, LX, Sport; High performance	US4014H
3.0L V6 2986cc 182 CID	1986-1992	GL, L, LX	US4034	5.0L V8 302 CID	1986	Base, Elan, LX, Sport	US4038
3.0L V6 2986cc 182 CID	1989-1995	SHO	US4061	5.0L V8 302 CID	1986	Base, Elan, LX, Sport; High performance	US4038H
3.0L V6 2986cc 182 CID	1993	GL, LX	US4034	5.0L V8 302 CID	1987-1988	Base, LX, Sport	US4038
3.0L V6 2986cc 182 CID	1994	GL, LX; From 02/1994	US4034	5.0L V8 302 CID	1987-1988	Base, LX, Sport; High performance	US4038H
3.0L V6 2986cc 182 CID	1994	GL, LX; To 01/1994	US4034	5.0L V8 302 CID	1991-1992	Base, LX	US4057
3.0L V6 2986cc 182 CID	1995	GL, LX, SE	US4094	5.0L V8 302 CID	1993	LX	US4057
3.0L V6 2986cc 182 CID	1996-1997	G, GL	US4094	5.1L V8 5114cc 312 CID	1956-1957		US488
3.0L V6 2986cc 182 CID	1998	SE, SE Comfort	US4094	5.8L V8 351 CID	1977-1979	MODIFIED	US932
3.0L V6 2986cc 182 CID	1999	LX, SE	US4094	5.8L V8 351 CID	1977-1979	WINDSOR	US953
3.0L V6 2986cc 182 CID	2000	LX, SE, SE Comfort, SES, SVG	US4094	5.8L V8 351 CID	1977-1979	High performance	US953H
3.0L V6 2986cc 182 CID	2001-2002	LX, SE, SES	US4094	6.4L V8 6391cc 390 CID	1961-1964		US723
3.0L V6 2986cc 182 CID	2003	LX, SE, SE Comfort, SEL, SES	US4094	6.6L V8 400 CID	1977-1978	MODIFIED	US932
3.0L V6 2986cc 182 CID	2004	LX, SE, SEL, SES	US4094	6.6L V8 6654cc 406 CID	1963		US723
3.0L V6 2986cc 182 CID	2005-2007	SE, SEL	US4094	7.0L V8 6997cc 427 CID	1963-1964		US723
3.2L V6 195 CID	1993-1995	SHO	US4082	7.5L V8 460 CID	1975-1976		US1114
3.4L V8 207 CID	1996-1999	SHO	US4106	<b>TOPAZ</b>			
3.5L V6 3496cc 213 CID	2008	Limited, SEL	US6023	2.3L L4 2294cc 140 CID	1986-1991	Mexican Application	US4022
3.5L V6 3496cc 213 CID	2009	Limited, SE, SEL	US6023	2.3L L4 2294cc 140 CID	1992-1994	Mexican Application	US4041
3.5L V6 3496cc 213 CID	2010	Limited, SE, SEL, SHO	US6023	2.3L L4 2300cc 140 CID	1984-1985	Mexican Application	US4022
3.5L V6 3496cc 213 CID	2011	SHO	US8910	3.0L V6 2985cc 182 CID	1992-1993	Mexican Application	US4070
3.5L V6 3496cc 213 CID	2011-2012	Limited, SE, SEL	US8980	<b>TORINO</b>			
3.5L V6 3496cc 213 CID	2012	SHO; From 01/02/2012	US8910	3.3L L6 200 CID	1968		US1044
3.5L V6 3496cc 213 CID	2012	SHO; To 01/02/2012	US8910	3.3L L6 3277cc 200 CID	1968		US1044
3.5L V6 3496cc 213 CID	2013-2018	Limited, SE, SEL, SHO	US8910	3.3L L6 3278cc 200 CID	1968		US1044
3.8L V6 232 CID	1988-1990	GL, LX	US4051	5.8L V8 351 CID	1975-1976	MODIFIED	US932
3.8L V6 232 CID	1991	GL, L, LX	US4051	5.8L V8 351 CID	1975-1976	High performance	US953H
3.8L V6 232 CID	1992-1993	GL, LX	US4051	5.8L V8 351 CID	1976	WINDSOR	US953
3.8L V6 232 CID	1994	GL, LX	US4089	6.6L V8 400 CID	1975-1976	MODIFIED	US932
3.8L V6 232 CID	1995	GL, LX, SE	US4089	7.5L V8 460 CID	1975-1976		US1114
<b>TAURUS X</b>				<b>TRANSIT</b>			
3.5L V6 3496cc 213 CID	2008-2009	Eddie Bauer, Limited, SEL	US6023	2.2L L4 2198cc 125 CID	2006-2014	Mexican Application	US8987
<b>TEMPO</b>				<b>TRANSIT-150</b>			
2.0L L4 1989cc 122 CID	1984-1986	Base, GL, GLX, LX	US9067	3.2L L5 195 CID	2016-2018	Base, XL, XLT	US8162
2.3L L4 140 CID	1984-1986	Base, GL, GLX, LX	US4022	3.5L V6 3496cc 213 CID	2015-2016	Base, XL, XLT; Serpentine Belt Driven	US8916
2.3L L4 140 CID	1987	AWD, GL, LX, Sport	US4022	3.5L V6 3496cc 213 CID	2015-2018	Base, XL, XLT	US8916
2.3L L4 140 CID	1988-1989	AWD, GL, GLS, LX, Sport	US4022	3.7L V6 3726cc 227 CID	2015	Base, XL, XLT	US6654
2.3L L4 140 CID	1990-1991	GL, GLS, L, L AWD, LX, LX AWD, Sport	US4022	3.7L V6 3726cc 227 CID	2015	Base, XL, XLT; Serpentine Belt Driven	US6654
2.3L L4 140 CID	1992	GL, LX	US4041	3.7L V6 3726cc 227 CID	2016-2018	Base, XL, XLT	US8916
2.3L L4 140 CID	1993	GL, LX; From 05/1993	US4041	<b>TRANSIT-250</b>			
2.3L L4 140 CID	1993	GL, LX; To 05/1993	US4041	3.2L L5 195 CID	2016-2018	Base, PTV	US8162
2.3L L4 140 CID	1994	GL, LX	US4041	3.5L V6 3496cc 213 CID	2015	Base	US8916
3.0L V6 2986cc 182 CID	1992	GL, GLS, LX, Sport	US4070	3.5L V6 3496cc 213 CID	2015-2016	Base; Serpentine Belt Driven	US8916
3.0L V6 2986cc 182 CID	1993-1994	GL, LX	US4070	3.5L V6 3496cc 213 CID	2016-2018	Base, PTV	US8916
<b>THUNDERBIRD</b>				<b>TRANSIT-350</b>			
2.3L L4 140 CID	1983-1988	Turbo	US4054	3.2L L5 195 CID	2016-2017	Base, XL, XLT	US8162
3.3L L6 200 CID	1980	Base, Silver Anniversary, Town Landau	US4002	3.2L L5 195 CID	2018	Base	US8162
3.3L L6 200 CID	1981-1982	Base, Heritage, Town Landau	US4002	3.5L V6 3496cc 213 CID	2015-2016	Base, XL, XLT; Serpentine Belt Driven	US8916
3.8L V6 232 CID	1982	Base, Heritage, Town Landau	US4016	3.5L V6 3496cc 213 CID	2015-2018	Base, XL, XLT	US8916
3.8L V6 232 CID	1983	Base, Heritage, LX, Sport	US4016	3.7L V6 3726cc 227 CID	2015	Base, XL, XLT	US6654
3.8L V6 232 CID	1984-1985	Base, Elan, Fila, LX, Sport	US4016	3.7L V6 3726cc 227 CID	2015	Base; Serpentine Belt Driven	US6654
3.8L V6 232 CID	1986	Base, Elan, LX, Sport	US4016	3.7L V6 3726cc 227 CID	2016-2018	Base, PTV	US8916
3.8L V6 232 CID	1987	Base, LX	US4016	<b>TRANSIT-350 HD</b>			
3.8L V6 232 CID	1988	Base, LX	US4050	3.2L L5 195 CID	2016-2017	Base, XL, XLT	US8162
3.8L V6 232 CID	1989	Base, LX, Super Coupe	US4050	3.2L L5 195 CID	2018	Base	US8162
3.8L V6 232 CID	1990-1992	Base, LX	US4050	3.5L V6 3496cc 213 CID	2015-2016	Base, XL, XLT; Serpentine Belt Driven	US8916
3.8L V6 232 CID	1990-1995	Super Coupe	US4055	3.5L V6 3496cc 213 CID	2015-2018	Base, XL, XLT	US8916
3.8L V6 232 CID	1993	LX	US4050	3.7L V6 3726cc 227 CID	2015	Base, XL, XLT	US6654
3.8L V6 232 CID	1994-1995	LX	US4090	3.7L V6 3726cc 227 CID	2015	Base, XL, XLT; Serpentine Belt Driven	US6654
3.8L V6 232 CID	1996-1997	LX	US4103	3.7L V6 3726cc 227 CID	2016-2018	Base, XL, XLT	US8916
3.8L V6 3800cc 232 CID	1984	Mexican Application	US4016	<b>TRANSIT CONNECT</b>			
3.9L V8 242 CID	2002-2003	Base	US4124	1.6L L4 1596cc 97 CID	2014-2016	Titanium, XL, XLT	US9449
3.9L V8 242 CID	2004	Base, Pacific Coast Roadster	US4124	1.6L L4 1596cc 97 CID	2016	Titanium, XL, XLT; From 06/29/2015	US9449
3.9L V8 242 CID	2005	50th Anniversary Edition, Base	US4124	2.0L L4 1999cc 122 CID	2010	XL, XLT	US4126
4.2L V8 255 CID	1980	Base, Town Landau	US4014	2.0L L4 1999cc 122 CID	2011-2013	XL, XLT, XLT Premium	US4126
4.2L V8 255 CID	1980	Base, Town Landau; High performance	US4014H	2.5L L4 2488cc 152 CID	2014-2018	Titanium, XL, XLT	US4126
4.2L V8 255 CID	1981-1982	Base, Heritage, Town Landau	US4014	<b>VAGONETA</b>			
4.2L V8 255 CID	1981-1982	Base, Heritage, Town Landau; High performance	US4014H	1.9L L4 1900cc 114 CID	1996-1997	Mexican Application	US4069
4.6L V8 281 CID	1994-1997	LX; Pump Length: long	US4113				
4.8L V8 4786cc 292 CID	1957		US488				
5.0L V8 302 CID	1977-1979	WINDSOR	US953				
5.0L V8 302 CID	1977-1979	High performance	US953H				
5.0L V8 302 CID	1980	Base, Silver Anniversary, Town Landau	US4014				
5.0L V8 302 CID	1980	Base, Silver Anniversary, Town Landau; High performance	US4014H				

WATER PUMPS

Engine	Years	Application Description	USMW	Engine	Years	Application Description	USMW
<b>FORD (cont'd.)</b>				<b>GMC (cont'd.)</b>			
<b>WINDSTAR</b>				<b>C15/C1500 SUBURBAN (cont'd.)</b>			
3.0L V6 2986cc 182 CID	1995-1997	Base, GL	US4094	6.5L V8 6489cc 396 CID	1968-1969		US981
3.0L V6 2986cc 182 CID	1998	3.0L, Base, GL	US4094	6.6L V8 402 CID	1970-1972		US981
3.0L V6 2986cc 182 CID	1999	3.0L, Base, SE, SEL	US4094	6.6L V8 6588cc 402 CID	1970-1972		US981
3.0L V6 2986cc 182 CID	2000	Base, SE, SEL	US4094	<b>C15 SUBURBAN</b>			
3.8L V6 232 CID	1995	Base, GL, LX	US4089	4.1L L6 250 CID	1975-1977		US1110
3.8L V6 232 CID	1996-1997	Base, GL, LX	US4102	4.1L L6 250 CID	1978		US1107
3.8L V6 232 CID	1998	Base, GL, Limited, LX	US4102	5.0L V8 305 CID	1977-1978		US1121
3.8L V6 232 CID	1999	Base, LX, SE, SEL	US4102	5.0L V8 305 CID	1977-1978	High performance	US1121H
3.8L V6 232 CID	2000	Base, Limited, LX, SE, SEL	US4102	5.7L V8 350 CID	1975-1976		US1109
3.8L V6 232 CID	2001-2003	Base, Limited, LX, SE, SEL, SE Sport	US4102	5.7L V8 350 CID	1975-1976	High performance	US1109H
3.8L V6 3800cc 232 CID	1994	Mexican Application	US4089	5.7L V8 350 CID	1977-1978		US1121
<b>GEO</b>				5.7L V8 350 CID	1977-1978	High performance	US1121H
<b>METRO</b>				<b>C25</b>			
1.0L L3 993cc 61 CID	1989-1994	Base, LSi, XFI	US5058	4.1L L6 250 CID	1977-1978		US1107
1.0L L3 993cc 61 CID	1995-1996	Base, LSi	US5058	4.8L L6 292 CID	1975-1977		US1137
1.0L L3 993cc 61 CID	1997	Base	US5058	4.8L L6 292 CID	1975-1977	High performance	US1137H
1.3L L4 1295cc 79 CID	1995	Base, LSi	US5058	4.8L L6 292 CID	1978		US5030
1.3L L4 1295cc 79 CID	1996-1997	LSi	US5058	5.0L V8 305 CID	1977-1978		US1121
<b>PRIZM</b>				5.0L V8 305 CID	1977-1978	High performance	US1121H
1.6L L4 1587cc	1990	Base	US9057	5.7L V8 350 CID	1975-1976		US1109
1.6L L4 1587cc	1990-1992	GSi	US9076	5.7L V8 350 CID	1975-1976	High performance	US1109H
1.6L L4 1587cc	1991-1992	Base, LSi	US9057	5.7L V8 350 CID	1977-1978		US1121
1.6L L4 1588cc 98 CID	1989	Base	US9057	5.7L V8 350 CID	1977-1978	High performance	US1121H
1.6L L4 1588cc 98 CID	1993-1997	Base, LSi	US9271	6.6L V8 400 CID	1976		US1109
1.8L L4 1788cc 110 CID	1993-1997	LSi	US9272	6.6L V8 400 CID	1976	High performance	US1109H
1.8L L4 1788cc 110 CID	1993-1997	LSi; Includes back housing	US9272-2	6.6L V8 400 CID	1977-1978		US1121
<b>SPECTRUM</b>				6.6L V8 400 CID	1977-1978	High performance	US1121H
1.5L L4 1471cc 92 CID	1989	Base	US5031	<b>C25/C2500 PICKUP</b>			
<b>STORM</b>				5.0L V6 5012cc 305 CID	1968-1969		US835
1.6L L4 1588cc 98 CID	1990-1991	2+2 GSi	US9220	6.5L V8 396 CID	1968-1969		US981
1.6L L4 1588cc 98 CID	1990-1993	2+2, Base	US9221	6.5L V8 6489cc 396 CID	1968-1969		US981
1.8L L4 1809cc 110 CID	1992-1993	2+2 GSi	US9221	6.6L V8 402 CID	1970-1972		US981
<b>TRACKER</b>				6.6L V8 6588cc 402 CID	1970-1972		US981
1.6L L4 1588cc 98 CID	1989	Base; 84.8mm	US5048	<b>C25/C2500 SUBURBAN</b>			
1.6L L4 1588cc 98 CID	1989	Base; 85.6mm	US5048	6.5L V8 396 CID	1968-1969		US981
1.6L L4 1588cc 98 CID	1989-1997	Base, LSi	US5048	6.5L V8 6489cc 396 CID	1968-1969		US981
1.6L L4 1588cc 98 CID	1995	Base, LSi; Early	US5048	6.6L V8 402 CID	1970-1972		US981
1.6L L4 1588cc 98 CID	1995	Base, LSi; Late	US5048	6.6L V8 6588cc 402 CID	1970-1972		US981
<b>GMC</b>				<b>C25 SUBURBAN</b>			
<b>ACADIA</b>				4.8L L6 292 CID	1975-1977		US1137
2.5L L4 2457cc 153 CID	2017	SL, SLE, SLT	US8102	4.8L L6 292 CID	1975-1977	High performance	US1137H
3.6L V6 222 CID	2017	Denali, SLE, SLT	US8148	4.8L L6 292 CID	1978		US5030
3.6L V6 3564cc 217 CID	2007-2009	SLE, SLT	US8932	5.0L V8 305 CID	1977-1978		US1121
3.6L V6 3564cc 217 CID	2010	SL, SLE, SLT	US8932	5.0L V8 305 CID	1977-1978	High performance	US1121H
3.6L V6 3564cc 217 CID	2010-2012	Mexican Application	US8932	5.7L V8 350 CID	1975-1976		US1109
3.6L V6 3564cc 217 CID	2011-2013	Denali, SL, SLE, SLT	US8932	5.7L V8 350 CID	1975-1976	High performance	US1109H
3.6L V6 3564cc 217 CID	2015	Denali, SLE, SLT	US8932	5.7L V8 350 CID	1977-1978		US1121
3.6L V6 3564cc 217 CID	2016	Denali, SL, SLE, SLT	US8932	5.7L V8 350 CID	1977-1978	High performance	US1121H
<b>ACADIA LIMITED</b>				6.6L V8 400 CID	1978		US1121
3.6L V6 3564cc 217 CID	2017	Base	US8932	6.6L V8 400 CID	1978	High performance	US1121H
<b>B7</b>				<b>C35/C3500 PICKUP</b>			
6.0L V8 366 CID	1993-1998	With threaded hub for fan clutch	US5078	5.0L V6 5012cc 305 CID	1968-1969		US835
7.0L V8 6998cc 427 CID	1994-1998	With threaded hub for fan clutch	US5078	6.5L V8 396 CID	1968-1969		US981
<b>B6000</b>				6.5L V8 6489cc 396 CID	1968-1969		US981
6.0L V8 366 CID	1980-1990	Without threaded hub	US5084	6.6L V8 402 CID	1970-1972		US981
6.0L V8 366 CID	1990-1991	With threaded hub for fan clutch	US5078	6.6L V8 6588cc 402 CID	1970-1972		US981
7.0L V8 427 CID	1980-1985	Without threaded hub	US5084	<b>C1500</b>			
<b>C15</b>				4.1L L6 250 CID	1979		US1107
4.1L L6 250 CID	1975-1977		US1110	4.1L L6 250 CID	1980	Base, Heavy Half, High Sierra, Sierra Classic, Sierra Grande, Street Coupe	US1107
4.1L L6 250 CID	1978		US1107	4.1L L6 250 CID	1981-1982	Base, High Sierra, Sierra Classic, Sierra Grande, Street Coupe	US1107
5.0L V8 305 CID	1977-1978		US1121	4.1L L6 250 CID	1983-1984	Base, High Sierra, Sierra Classic	US1107
5.0L V8 305 CID	1977-1978	High performance	US1121H	4.1L L6 4100cc 250 CID	1980-1984	Mexican Application	US1107
5.7L V8 350 CID	1975-1976		US1109	4.1L L6 4100cc 250 CID	1994-1997	Mexican Application	US895
5.7L V8 350 CID	1975-1976	High performance	US1109H	4.3L V6 262 CID	1985-1986	Base, High Sierra, Sierra Classic	US1121
5.7L V8 350 CID	1977-1978		US1121	4.3L V6 262 CID	1985-1986	Base, High Sierra, Sierra Classic; High performance	US1121H
5.7L V8 350 CID	1977-1978	High performance	US1121H	4.3L V6 262 CID	1988-1993	Sierra, Sierra SLE, Sierra SLX	US5049
6.6L V8 400 CID	1976		US1109	4.3L V6 262 CID	1988-1993	Sierra, Sierra SLE, Sierra SLX; High performance	US5049H
6.6L V8 400 CID	1976	High performance	US1109H	4.3L V6 262 CID	1994-1995	Sierra SL, Sierra SLE, Sierra SLT, Sierra Special	US5049
6.6L V8 400 CID	1978		US1121	4.3L V6 262 CID	1994-1995	Sierra SL, Sierra SLE, Sierra SLT, Sierra Special; High performance	US5049H
6.6L V8 400 CID	1978	High performance	US1121H	4.3L V6 262 CID	1996	Sierra SL, Sierra SLE, Sierra SLT, Sierra Special	US5077
<b>C15/C1500 PICKUP</b>				4.3L V6 262 CID	1996	Sierra SL, Sierra SLE, Sierra SLT, Sierra Special; High performance	US5077H
5.0L V6 5012cc 305 CID	1968-1969		US835	4.3L V6 262 CID	1997	Sierra GT, Sierra SL, Sierra SLE, Sierra SLT, Sierra Special	US5077
6.5L V8 396 CID	1968-1969		US981	4.3L V6 262 CID	1997	Sierra GT, Sierra SL, Sierra SLE, Sierra SLT, Sierra Special; High performance	US5077H
6.5L V8 6489cc 396 CID	1968-1969		US981	<b>C15/C1500 SUBURBAN</b>			
6.6L V8 402 CID	1970-1972		US981	6.5L V8 396 CID	1968-1969		US981
6.6L V8 6588cc 402 CID	1970-1972		US981				



Engine	Years	Application Description	USMW	Engine	Years	Application Description	USMW
<b>GMC (cont'd.)</b>				<b>GMC (cont'd.)</b>			
<b>C1500 (cont'd.)</b>				<b>C1500 (cont'd.)</b>			
4.3L V6 262 CID	1998	Sierra SL, Sierra SLE, Sierra SLT, Sierra Special	US5077	6.2L V8 379 CID	1982	Base, High Sierra, Sierra Classic, Sierra Grande, Street Coupe	US5008
4.3L V6 262 CID	1998	Sierra SL, Sierra SLE, Sierra SLT, Sierra Special; High performance	US5077H	6.2L V8 379 CID	1983-1986	Base, High Sierra, Sierra Classic	US5008
4.8L L6 292 CID	1980	Base, Heavy Half, High Sierra, Sierra Classic, Sierra Grande, Street Coupe	US5030	6.2L V8 379 CID	1988-1993	Sierra, Sierra SLE, Sierra SLX	US5062
4.8L L6 4800cc 292 CID	1981-1986	Mexican Application	US5030	6.5L V8 395 CID	1994-1995	Sierra SL, Sierra SLE, Sierra SLT, Sierra Special	US5062
5.0L V8 305 CID	1979		US1121	6.5L V8 395 CID	1996	Sierra SL, Sierra SLE, Sierra SLT, Sierra Special; Early	US5062
5.0L V8 305 CID	1979	High performance	US1121H	6.5L V8 395 CID	1996	Sierra SL, Sierra SLE, Sierra SLT, Sierra Special; Late	US5074
5.0L V8 305 CID	1980	Base, Heavy Half, High Sierra, Sierra Classic, Sierra Grande, Street Coupe	US1121	6.5L V8 395 CID	1997	Sierra GT, Sierra SL, Sierra SLE, Sierra SLT, Sierra Special	US5074
5.0L V8 305 CID	1980	Base, Heavy Half, High Sierra, Sierra Classic, Sierra Grande, Street Coupe; High performance	US1121H	6.6L V8 400 CID	1979		US1121
5.0L V8 305 CID	1981-1982	Base, High Sierra, Sierra Classic, Sierra Grande, Street Coupe	US1121	6.6L V8 400 CID	1979	High performance	US1121H
5.0L V8 305 CID	1981-1982	Base, High Sierra, Sierra Classic, Sierra Grande, Street Coupe; High performance	US1121H	6.6L V8 400 CID	1980	Base, Heavy Half, High Sierra, Sierra Classic, Sierra Grande, Street Coupe	US1121
5.0L V8 305 CID	1983-1986	Base, High Sierra, Sierra Classic	US1121	6.6L V8 400 CID	1980	Base, Heavy Half, High Sierra, Sierra Classic, Sierra Grande, Street Coupe; High performance	US1121H
5.0L V8 305 CID	1983-1986	Base, High Sierra, Sierra Classic; High performance	US1121H	7.4L V8 454 CID	1980	Base, Heavy Half, High Sierra, Sierra Classic, Sierra Grande, Street Coupe	US1002
5.0L V8 305 CID	1988-1993	Sierra, Sierra SLE, Sierra SLX	US5049	7.4L V8 454 CID	1980	Base, Heavy Half, High Sierra, Sierra Classic, Sierra Grande, Street Coupe; High performance	US1002H
5.0L V8 305 CID	1988-1993	Sierra, Sierra SLE, Sierra SLX; High performance	US5049H	<b>C1500 SUBURBAN</b>			
5.0L V8 305 CID	1994-1995	Sierra SL, Sierra SLE, Sierra SLT, Sierra Special	US5049	4.1L L6 250 CID	1979		US1107
5.0L V8 305 CID	1994-1995	Sierra SL, Sierra SLE, Sierra SLT, Sierra Special; High performance	US5049H	4.1L L6 250 CID	1980	Base, High Sierra, Sierra Classic, Sierra Grande	US1107
5.0L V8 305 CID	1996	Sierra SL, Sierra SLE, Sierra SLT, Sierra Special	US5077	5.0L V8 305 CID	1979		US1121
5.0L V8 305 CID	1996	Sierra SL, Sierra SLE, Sierra SLT, Sierra Special; High performance	US5077H	5.0L V8 305 CID	1979	High performance	US1121H
5.0L V8 305 CID	1997	Sierra GT, Sierra SL, Sierra SLE, Sierra SLT, Sierra Special	US5077	5.0L V8 305 CID	1980-1982	Base, High Sierra, Sierra Classic, Sierra Grande	US1121
5.0L V8 305 CID	1997	Sierra GT, Sierra SL, Sierra SLE, Sierra SLT, Sierra Special; High performance	US5077H	5.0L V8 305 CID	1980-1982	Base, High Sierra, Sierra Classic, Sierra Grande; High performance	US1121H
5.0L V8 305 CID	1998	Sierra SL, Sierra SLE, Sierra SLT, Sierra Special	US5077	5.0L V8 305 CID	1983-1986	Base, High Sierra, Sierra Classic	US1121
5.0L V8 305 CID	1998	Sierra SL, Sierra SLE, Sierra SLT, Sierra Special; High performance	US5077H	5.0L V8 305 CID	1983-1986	Base, High Sierra, Sierra Classic; High performance	US1121H
5.0L V8 305 CID	1999	Sierra SL, Sierra SLE, Sierra SLT	US5077	5.7L V8 350 CID	1979		US1121
5.0L V8 305 CID	1999	Sierra SL, Sierra SLE, Sierra SLT; High performance	US5077H	5.7L V8 350 CID	1979	High performance	US1121H
5.7L V8 350 CID	1979		US1121	5.7L V8 350 CID	1980-1982	Base, High Sierra, Sierra Classic, Sierra Grande	US1121
5.7L V8 350 CID	1979	High performance	US1121H	5.7L V8 350 CID	1980-1982	Base, High Sierra, Sierra Classic, Sierra Grande; High performance	US1121H
5.7L V8 350 CID	1980	Base, Heavy Half, High Sierra, Sierra Classic, Sierra Grande, Street Coupe	US1121	5.7L V8 350 CID	1983-1986	Base, High Sierra, Sierra Classic	US1121
5.7L V8 350 CID	1980	Base, Heavy Half, High Sierra, Sierra Classic, Sierra Grande, Street Coupe; High performance	US1121H	5.7L V8 350 CID	1983-1986	Base, High Sierra, Sierra Classic; High performance	US1121H
5.7L V8 350 CID	1981-1982	Base, High Sierra, Sierra Classic, Sierra Grande, Street Coupe	US1121	5.7L V8 350 CID	1992	Base, SLE; 6.9" HUB HEIGHT	US5049
5.7L V8 350 CID	1981-1982	Base, High Sierra, Sierra Classic, Sierra Grande, Street Coupe; High performance	US1121H	5.7L V8 350 CID	1992	Base, SLE; 6.9" HUB HEIGHT, High performance	US5049H
5.7L V8 350 CID	1983-1986	Base, High Sierra, Sierra Classic	US1121	5.7L V8 350 CID	1992	Base, SLE; 5.8" HUB HEIGHT	US5073
5.7L V8 350 CID	1983-1986	Base, High Sierra, Sierra Classic; High performance	US1121H	5.7L V8 350 CID	1993-1994	Base, SLE	US5049
5.7L V8 350 CID	1988-1991	Sierra, Sierra SLE, Sierra SLX	US5049	5.7L V8 350 CID	1993-1994	Base, SLE; High performance	US5049H
5.7L V8 350 CID	1988-1991	Sierra, Sierra SLE, Sierra SLX; High performance	US5049H	5.7L V8 350 CID	1995	Base, SLE, SLT	US5049
5.7L V8 350 CID	1992	Sierra, Sierra SLE, Sierra SLX; 6.9" HUB HEIGHT	US5049	5.7L V8 350 CID	1995	Base, SLE, SLT; High performance	US5049H
5.7L V8 350 CID	1992	Sierra, Sierra SLE, Sierra SLX; 6.9" HUB HEIGHT, High performance	US5049H	5.7L V8 350 CID	1996-1999	Base, SLE, SLT	US5077
5.7L V8 350 CID	1992	Sierra, Sierra SLE, Sierra SLX; 5.8" HUB HEIGHT	US5073	5.7L V8 350 CID	1996-1999	Base, SLE, SLT; High performance	US5077H
5.7L V8 350 CID	1993	Sierra, Sierra SLE, Sierra SLX	US5049	6.2L V8 379 CID	1982	Base, High Sierra, Sierra Classic, Sierra Grande	US5008
5.7L V8 350 CID	1993	Sierra, Sierra SLE, Sierra SLX; High performance	US5049H	6.2L V8 379 CID	1983-1986	Base, High Sierra, Sierra Classic	US5008
5.7L V8 350 CID	1994-1995	Sierra SL, Sierra SLE, Sierra SLT, Sierra Special	US5049	6.5L V8 395 CID	1995	Base, SLE, SLT	US5062
5.7L V8 350 CID	1994-1995	Sierra SL, Sierra SLE, Sierra SLT, Sierra Special; High performance	US5049H	6.5L V8 395 CID	1996	Base, SLE, SLT; Early	US5062
5.7L V8 350 CID	1996	Sierra SL, Sierra SLE, Sierra SLT, Sierra Special	US5077	6.5L V8 395 CID	1996	Base, SLE, SLT; Late	US5074
5.7L V8 350 CID	1996	Sierra SL, Sierra SLE, Sierra SLT, Sierra Special; High performance	US5077H	6.5L V8 395 CID	1997-1998	Base, SLE, SLT	US5074
5.7L V8 350 CID	1997	Sierra GT, Sierra SL, Sierra SLE, Sierra SLT, Sierra Special	US5077	6.5L V8 395 CID	1999	Base, SLE, SLT; Bolt on pulley	US5074
5.7L V8 350 CID	1997	Sierra GT, Sierra SL, Sierra SLE, Sierra SLT, Sierra Special; High performance	US5077H	6.5L V8 395 CID	1999	Base, SLE, SLT	US5086
5.7L V8 350 CID	1998	Sierra SL, Sierra SLE, Sierra SLT, Sierra Special	US5077	7.4L V8 454 CID	1980	Base, High Sierra, Sierra Classic, Sierra Grande	US1002
5.7L V8 350 CID	1998	Sierra SL, Sierra SLE, Sierra SLT, Sierra Special; High performance	US5077H	7.4L V8 454 CID	1980	Base, High Sierra, Sierra Classic, Sierra Grande; High performance	US1002H
5.7L V8 350 CID	1999	Sierra SL, Sierra SLE, Sierra SLT	US5077	<b>C2500</b>			
5.7L V8 350 CID	1999	Sierra SL, Sierra SLE, Sierra SLT; High performance	US5077H	4.1L L6 250 CID	1979		US1107
5.7L V8 5700cc 350 CID	1981-1985	Mexican Application	US1121	4.1L L6 250 CID	1980-1982	Base, High Sierra, Sierra Classic, Sierra Grande	US1107
5.7L V8 5700cc 350 CID	1987-1988	Mexican Application	US1121	4.1L L6 250 CID	1983-1984	Base, High Sierra, Sierra Classic	US1107
5.7L V8 5700cc 350 CID	1989-1990	Mexican Application	US5049	4.3L V6 262 CID	1985-1986	Base, High Sierra, Sierra Classic	US1121
				4.3L V6 262 CID	1985-1986	Base, High Sierra, Sierra Classic; High performance	US1121H
				4.3L V6 262 CID	1988-1993	Sierra, Sierra SLE, Sierra SLX	US5049
				4.3L V6 262 CID	1988-1993	Sierra, Sierra SLE, Sierra SLX; High performance	US5049H
				4.3L V6 262 CID	1994-1995	Sierra SL, Sierra SLE	US5049
				4.3L V6 262 CID	1994-1995	Sierra SL, Sierra SLE; High performance	US5049H
				4.8L L6 292 CID	1979		US5030
				4.8L L6 292 CID	1980-1982	Base, High Sierra, Sierra Classic, Sierra Grande	US5030
				4.8L L6 292 CID	1983-1986	Base, High Sierra, Sierra Classic	US5030
				5.0L V8 305 CID	1979		US1121
				5.0L V8 305 CID	1979	High performance	US1121H
				5.0L V8 305 CID	1980-1982	Base, High Sierra, Sierra Classic, Sierra Grande	US1121

WATER PUMPS

Engine	Years	Application Description	USMW	Engine	Years	Application Description	USMW
<b>GMC (cont'd.)</b>				<b>GMC (cont'd.)</b>			
<b>C2500 (cont'd.)</b>				<b>C2500 SUBURBAN (cont'd.)</b>			
5.0L V8 305 CID	1980-1982	Base, High Sierra, Sierra Classic, Sierra Grande; High performance	US1121H	5.7L V8 350 CID	1995	Base, SLE, SLT; High performance	US5049H
5.0L V8 305 CID	1983-1986	Base, High Sierra, Sierra Classic	US1121	5.7L V8 350 CID	1996-1999	Base, SLE, SLT	US5077
5.0L V8 305 CID	1983-1986	Base, High Sierra, Sierra Classic; High performance	US1121H	5.7L V8 350 CID	1996-1999	Base, SLE, SLT; High performance	US5077H
5.0L V8 305 CID	1988-1993	Sierra, Sierra SLE, Sierra SLX	US5049	6.2L V8 379 CID	1982	Base, High Sierra, Sierra Classic, Sierra Grande	US5008
5.0L V8 305 CID	1988-1993	Sierra, Sierra SLE, Sierra SLX; High performance	US5049H	6.2L V8 379 CID	1983-1986	Base, High Sierra, Sierra Classic	US5008
5.0L V8 305 CID	1994-1995	Sierra SL, Sierra SLE, Sierra SLT	US5049	6.5L V8 395 CID	1994	Base, SLE	US5062
5.0L V8 305 CID	1994-1995	Sierra SL, Sierra SLE, Sierra SLT; High performance	US5049H	6.5L V8 395 CID	1995	Base, SLE, SLT	US5062
5.0L V8 305 CID	1996-1998	Sierra SL, Sierra SLE, Sierra SLT	US5077	6.5L V8 395 CID	1996	Base, SLE, SLT; Early	US5062
5.0L V8 305 CID	1996-1998	Sierra SL, Sierra SLE, Sierra SLT; High performance	US5077H	6.5L V8 395 CID	1996	Base, SLE, SLT; Late	US5074
5.7L V8 350 CID	1979		US1121	6.5L V8 395 CID	1997-1998	Base, SLE, SLT	US5074
5.7L V8 350 CID	1979	High performance	US1121H	6.5L V8 395 CID	1999	Base, SLE, SLT; Bolt on pulley	US5074
5.7L V8 350 CID	1980-1982	Base, High Sierra, Sierra Classic, Sierra Grande	US1121	6.5L V8 395 CID	1999	Base, SLE, SLT	US5086
5.7L V8 350 CID	1980-1982	Base, High Sierra, Sierra Classic, Sierra Grande; High performance	US1121H	6.6L V8 400 CID	1980	Base, High Sierra, Sierra Classic, Sierra Grande	US1121
5.7L V8 350 CID	1983-1986	Base, High Sierra, Sierra Classic	US1121	6.6L V8 400 CID	1980	Base, High Sierra, Sierra Classic, Sierra Grande; High performance	US1121H
5.7L V8 350 CID	1983-1986	Base, High Sierra, Sierra Classic; High performance	US1121H	7.4L V8 454 CID	1980-1982	Base, High Sierra, Sierra Classic, Sierra Grande	US1002
5.7L V8 350 CID	1988-1993	Sierra, Sierra SLE, Sierra SLX	US5049	7.4L V8 454 CID	1980-1982	Base, High Sierra, Sierra Classic, Sierra Grande; High performance	US1002H
5.7L V8 350 CID	1988-1993	Sierra, Sierra SLE, Sierra SLX; High performance	US5049H	7.4L V8 454 CID	1983-1986	Base, High Sierra, Sierra Classic	US1002
5.7L V8 350 CID	1994-1995	Sierra SL, Sierra SLE, Sierra SLT	US5049	7.4L V8 454 CID	1983-1986	Base, High Sierra, Sierra Classic; High performance	US1002H
5.7L V8 350 CID	1994-1995	Sierra SL, Sierra SLE, Sierra SLT; High performance	US5049H	7.4L V8 454 CID	1992-1994	Base, SLE	US5038
5.7L V8 350 CID	1996-2000	Sierra SL, Sierra SLE, Sierra SLT	US5077	7.4L V8 454 CID	1992-1994	Base, SLE; High performance	US5038H
5.7L V8 350 CID	1996-2000	Sierra SL, Sierra SLE, Sierra SLT; High performance	US5077H	7.4L V8 454 CID	1995-1999	Base, SLE, SLT	US5038
5.7L V8 5700cc 350 CID	1985	Mexican Application	US1121	7.4L V8 454 CID	1995-1999	Base, SLE, SLT; High performance	US5038H
5.7L V8 5700cc 350 CID	1987-1988	Mexican Application	US1121	<b>C3500</b>			
5.7L V8 5700cc 350 CID	1989-1991	Mexican Application	US5049	4.1L L6 250 CID	1980	Base, High Sierra, Sierra Classic, Sierra Grande	US1107
6.2L V8 379 CID	1982	Base, High Sierra, Sierra Classic, Sierra Grande	US5008	4.8L L6 292 CID	1980-1982	Base, High Sierra, Sierra Classic, Sierra Grande	US5030
6.2L V8 379 CID	1983-1986	Base, High Sierra, Sierra Classic	US5008	4.8L L6 292 CID	1983-1986	Base, High Sierra, Sierra Classic	US5030
6.2L V8 379 CID	1988-1993	Sierra, Sierra SLE, Sierra SLX	US5062	5.0L V8 305 CID	1986	Base, High Sierra, Sierra Classic	US1121
6.5L V8 395 CID	1992-1993	Sierra, Sierra SLE, Sierra SLX	US5062	5.0L V8 305 CID	1986	Base, High Sierra, Sierra Classic; High performance	US1121H
6.5L V8 395 CID	1994-1995	Sierra SL, Sierra SLE, Sierra SLT	US5062	5.7L V8 350 CID	1980-1982	Base, High Sierra, Sierra Classic, Sierra Grande	US1121
6.5L V8 395 CID	1996	Sierra SL, Sierra SLE, Sierra SLT; Early	US5062	5.7L V8 350 CID	1980-1982	Base, High Sierra, Sierra Classic, Sierra Grande; High performance	US1121H
6.5L V8 395 CID	1996	Sierra SL, Sierra SLE, Sierra SLT; Late	US5074	5.7L V8 350 CID	1983-1986	Base, High Sierra, Sierra Classic	US1121
6.5L V8 395 CID	1997-1998	Sierra SL, Sierra SLE, Sierra SLT	US5074	5.7L V8 350 CID	1983-1986	Base, High Sierra, Sierra Classic; High performance	US1121H
6.5L V8 395 CID	1999	Sierra SL, Sierra SLE, Sierra SLT; Bolt on pulley	US5074	5.7L V8 350 CID	1988-1993	Sierra, Sierra SLE, Sierra SLX	US5049
6.5L V8 395 CID	1999-2000	Sierra SL, Sierra SLE, Sierra SLT	US5086	5.7L V8 350 CID	1988-1993	Sierra, Sierra SLE, Sierra SLX; High performance	US5049H
6.6L V8 400 CID	1979		US1121	5.7L V8 350 CID	1994-1995	Sierra SL, Sierra SLE, Sierra SLT	US5049
6.6L V8 400 CID	1979	High performance	US1121H	5.7L V8 350 CID	1994-1995	Sierra SL, Sierra SLE, Sierra SLT; High performance	US5049H
7.4L V8 454 CID	1980-1982	Base, High Sierra, Sierra Classic, Sierra Grande	US1002	5.7L V8 350 CID	1996-2000	Sierra SL, Sierra SLE, Sierra SLT	US5077
7.4L V8 454 CID	1980-1982	Base, High Sierra, Sierra Classic, Sierra Grande; High performance	US1002H	5.7L V8 350 CID	1996-2000	Sierra SL, Sierra SLE, Sierra SLT; High performance	US5077H
7.4L V8 454 CID	1983-1986	Base, High Sierra, Sierra Classic	US1002	5.7L V8 5700cc 350 CID	1980-1985	Mexican Application	US1121
7.4L V8 454 CID	1983-1986	Base, High Sierra, Sierra Classic; High performance	US1002H	5.7L V8 5700cc 350 CID	1987-1988	Mexican Application	US1121
7.4L V8 454 CID	1991-1993	Sierra, Sierra SLE, Sierra SLX	US5038	5.7L V8 5700cc 350 CID	1989-1991	Mexican Application	US5049
7.4L V8 454 CID	1991-1993	Sierra, Sierra SLE, Sierra SLX; High performance	US5038H	6.2L V8 379 CID	1982	Base, High Sierra, Sierra Classic, Sierra Grande	US5008
7.4L V8 454 CID	1994-2000	Sierra SL, Sierra SLE, Sierra SLT	US5038	6.2L V8 379 CID	1983-1986	Base, High Sierra, Sierra Classic	US5008
7.4L V8 454 CID	1994-2000	Sierra SL, Sierra SLE, Sierra SLT; High performance	US5038H	6.2L V8 379 CID	1988-1993	Sierra, Sierra SLE, Sierra SLX	US5062
<b>C2500 SUBURBAN</b>				6.5L V8 395 CID	1992-1993	Sierra, Sierra SLE, Sierra SLX	US5062
4.8L L6 292 CID	1979		US5030	6.5L V8 395 CID	1994-1995	Sierra SL, Sierra SLE, Sierra SLT	US5062
4.8L L6 292 CID	1980-1982	Base, High Sierra, Sierra Classic, Sierra Grande	US5030	6.5L V8 395 CID	1996	Sierra SL, Sierra SLE, Sierra SLT; Early	US5062
4.8L L6 292 CID	1984	Base, High Sierra, Sierra Classic	US5030	6.5L V8 395 CID	1996	Sierra SL, Sierra SLE, Sierra SLT; Late	US5074
5.0L V8 305 CID	1982	Base, High Sierra, Sierra Classic, Sierra Grande	US1121	6.5L V8 395 CID	1997-1998	Sierra SL, Sierra SLE, Sierra SLT	US5074
5.0L V8 305 CID	1982	Base, High Sierra, Sierra Classic, Sierra Grande; High performance	US1121H	6.5L V8 395 CID	1999	Sierra SL, Sierra SLE, Sierra SLT; Bolt on pulley	US5074
5.0L V8 305 CID	1983-1986	Base, High Sierra, Sierra Classic	US1121	6.5L V8 395 CID	1999-2000	Sierra SL, Sierra SLE, Sierra SLT	US5086
5.0L V8 305 CID	1983-1986	Base, High Sierra, Sierra Classic; High performance	US1121H	7.4L V8 454 CID	1980-1982	Base, High Sierra, Sierra Classic, Sierra Grande	US1002
5.7L V8 350 CID	1979		US1121	7.4L V8 454 CID	1980-1982	Base, High Sierra, Sierra Classic, Sierra Grande; High performance	US1002H
5.7L V8 350 CID	1979	High performance	US1121H	7.4L V8 454 CID	1983-1986	Base, High Sierra, Sierra Classic	US1002
5.7L V8 350 CID	1980-1982	Base, High Sierra, Sierra Classic, Sierra Grande	US1121	7.4L V8 454 CID	1983-1986	Base, High Sierra, Sierra Classic; High performance	US1002H
5.7L V8 350 CID	1980-1982	Base, High Sierra, Sierra Classic, Sierra Grande; High performance	US1121H	7.4L V8 454 CID	1988-1993	Sierra, Sierra SLE, Sierra SLX	US5062
5.7L V8 350 CID	1983-1986	Base, High Sierra, Sierra Classic	US1121	7.4L V8 454 CID	1992-1993	Sierra, Sierra SLE, Sierra SLX	US5062
5.7L V8 350 CID	1983-1986	Base, High Sierra, Sierra Classic; High performance	US1121H	7.4L V8 454 CID	1994-1995	Sierra SL, Sierra SLE, Sierra SLT	US5062
5.7L V8 350 CID	1992	Base, SLE; 6.9" HUB HEIGHT	US5049	7.4L V8 454 CID	1996	Sierra SL, Sierra SLE, Sierra SLT; Early	US5062
5.7L V8 350 CID	1992	Base, SLE; 6.9" HUB HEIGHT, High performance	US5049H	7.4L V8 454 CID	1996	Sierra SL, Sierra SLE, Sierra SLT; Late	US5074
5.7L V8 350 CID	1992	Base, SLE; 5.8" HUB HEIGHT	US5073	7.4L V8 454 CID	1997-1998	Sierra SL, Sierra SLE, Sierra SLT	US5074
5.7L V8 350 CID	1993-1994	Base, SLE	US5049	7.4L V8 454 CID	1999	Sierra SL, Sierra SLE, Sierra SLT; Bolt on pulley	US5074
5.7L V8 350 CID	1993-1994	Base, SLE; High performance	US5049H	7.4L V8 454 CID	1999-2000	Sierra SL, Sierra SLE, Sierra SLT	US5086
5.7L V8 350 CID	1995	Base, SLE, SLT	US5049	7.4L V8 454 CID	1980-1982	Base, High Sierra, Sierra Classic, Sierra Grande	US1002
				<b>C5000 TOPKICK</b>			
				6.0L V8 366 CID	1990	Without threaded hub	US5084
				6.0L V8 366 CID	1990-1991	With threaded hub for fan clutch	US5078
				<b>C6000</b>			
				6.0L V8 366 CID	1980-1990	Without threaded hub	US5084
				6.0L V8 366 CID	1990	With threaded hub for fan clutch	US5078
				7.0L V8 427 CID	1990	With threaded hub for fan clutch	US5078

Engine	Years	Application Description	USMW	Engine	Years	Application Description	USMW
<b>GMC (cont'd.)</b>				<b>GMC (cont'd.)</b>			
<b>C6000 (cont'd.)</b>				<b>CANYON (cont'd.)</b>			
7.0L V8 427 CID	1990	Without threaded hub	US5084	2.8L L4 171 CID	2017	Denali, SLE, SLT	US8154
<b>C6000 TOPKICK</b>				2.8L L4 2770cc 169 CID	2004	SL, SLE, Z71 Fleet, Z71 SL, Z71 SLE, Z85 SLE	US5097
6.0L V8 366 CID	1990	Without threaded hub	US5084	2.8L L4 2770cc 169 CID	2005	Z71 Fleet, Z71 SL, Z71 SLE, Z85 SL, Z85 SLE	US5097
6.0L V8 366 CID	1990-1996	With threaded hub for fan clutch	US5078	2.8L L4 2770cc 169 CID	2006	SL, SLE, WT	US5097
7.0L V8 6998cc 427 CID	1990	Without threaded hub	US5084	2.9L L4 2921cc 178 CID	2007	SL, SLE, WT	US5097
7.0L V8 6998cc 427 CID	1990-1996	With threaded hub for fan clutch	US5078	2.9L L4 2921cc 178 CID	2008	SL, SLE, SLT, WT	US5097
<b>C6500 TOPKICK</b>				2.9L L4 2921cc 178 CID	2009	SLE, SLT, WT	US5097
6.0L V8 366 CID	1997-1998	With threaded hub for fan clutch	US5078	2.9L L4 2921cc 178 CID	2010-2012	SLE, WT	US5097
7.0L V8 6998cc 427 CID	1997-1998	With threaded hub for fan clutch	US5078	3.5L L5 3460cc 211 CID	2004	SL, SLE, Z71 Fleet, Z71 SL, Z71 SLE, Z85 SL, Z85 SLE	US5097
<b>C7000</b>				3.5L L5 3460cc 211 CID	2005	Z71 Fleet, Z71 SL, Z71 SLE, Z85 SL, Z85 SLE	US5097
6.0L V8 366 CID	1980-1990	Without threaded hub	US5084	3.5L L5 3460cc 211 CID	2006	SLE, SLT, WT	US5097
6.0L V8 366 CID	1990	With threaded hub for fan clutch	US5078	3.6L V6 222 CID	2017	Base, Denali, SLE, SLT	US8153
7.0L V8 427 CID	1980-1990	Without threaded hub	US5084	3.6L V6 3564cc 217 CID	2015-2016	Base, SLE, SLT	US8932
7.0L V8 427 CID	1990	With threaded hub for fan clutch	US5078	3.7L L5 3654cc 223 CID	2007-2012	SLE, SLT, WT	US5097
7.4L V8 454 CID	1980	Without threaded hub	US5084	3.7L L5 3654cc 223 CID	2010-2012	Mexican Application	US5097
<b>C7000 TOPKICK</b>				5.3L V8 5328cc 325 CID	2009	SLT	US6009
6.0L V8 366 CID	1990	Without threaded hub	US5084	5.3L V8 5328cc 325 CID	2009	SLT; Includes thermostat and thermostat housing	US6009-T
6.0L V8 366 CID	1990-1996	With threaded hub for fan clutch	US5078	5.3L V8 5328cc 325 CID	2010-2012	SLE, SLT	US6009
7.0L V8 6998cc 427 CID	1990	Without threaded hub	US5084	5.3L V8 5328cc 325 CID	2010-2012	SLE, SLT; Includes thermostat and thermostat housing	US6009-T
7.0L V8 6998cc 427 CID	1990-1996	With threaded hub for fan clutch	US5078	<b>ENVOY</b>			
<b>C7500 TOPKICK</b>				4.2L L6 256 CID	2002-2009	SLE, SLT	US5097
6.0L V8 366 CID	1997-1998	With threaded hub for fan clutch	US5078	5.3L V8 5328cc 325 CID	2005-2006	Denali	US64
<b>CABALLERO</b>				5.3L V8 5328cc 325 CID	2005-2006	Denali; Includes thermostat and thermostat housing	US64-T
3.3L V6 200 CID	1978-1979		US1121	5.3L V8 5328cc 325 CID	2007-2009	Denali	US6009
3.3L V6 200 CID	1978-1979	High performance	US1121H	5.3L V8 5328cc 325 CID	2007-2009	Denali; Includes thermostat and thermostat housing	US6009-T
3.8L V6 229 CID	1980	Base, Diablo, Laredo	US1121	<b>ENVOY XL</b>			
3.8L V6 229 CID	1980	Base, Diablo, Laredo; High performance	US1121H	4.2L L6 256 CID	2002-2006	SLE, SLT	US5097
3.8L V6 229 CID	1981	Amarillo, Base, Conquista, Diablo, Royal Knight	US1121	5.3L V8 5328cc 325 CID	2003-2004	SLE, SLT	US64
3.8L V6 229 CID	1981	Amarillo, Base, Conquista, Diablo, Royal Knight; High performance	US1121H	5.3L V8 5328cc 325 CID	2003-2004	SLE, SLT; Includes thermostat and thermostat housing	US64-T
3.8L V6 229 CID	1982-1983	Amarillo, Base, Diablo	US1121	5.3L V8 5328cc 325 CID	2005	Denali, SLE, SLT	US64
3.8L V6 229 CID	1982-1983	Amarillo, Base, Diablo; High performance	US1121H	5.3L V8 5328cc 325 CID	2005	Denali, SLE, SLT; Includes thermostat and thermostat housing	US64-T
3.8L V6 229 CID	1984	Base, Diablo	US1121	5.3L V8 5328cc 325 CID	2006	Denali	US64
3.8L V6 229 CID	1984	Base, Diablo; High performance	US1121H	5.3L V8 5328cc 325 CID	2006	Denali; Includes thermostat and thermostat housing	US64-T
3.8L V6 3800cc 231 CID	1980	Base, Diablo, Laredo	US1018	<b>ENVOY XUV</b>			
3.8L V6 3800cc 231 CID	1980	Base, Diablo, Laredo; High performance	US1018H	4.2L L6 256 CID	2004-2005	SLE, SLT	US5097
3.8L V6 3800cc 231 CID	1981	Amarillo, Base, Conquista, Diablo, Royal Knight	US1018	5.3L V8 5328cc 325 CID	2004-2005	SLE, SLT	US64
3.8L V6 3800cc 231 CID	1981	Amarillo, Base, Conquista, Diablo, Royal Knight; High performance	US1018H	5.3L V8 5328cc 325 CID	2004-2005	SLE, SLT; Includes thermostat and thermostat housing	US64-T
3.8L V6 3800cc 231 CID	1982-1984	Amarillo, Base, Diablo	US1018	<b>G15</b>			
3.8L V6 3800cc 231 CID	1982-1984	Amarillo, Base, Diablo; High performance	US1018H	4.1L L6 250 CID	1975-1977		US1110
4.3L V6 262 CID	1985-1986	Amarillo, Base, Diablo	US1121	4.1L L6 250 CID	1978		US1107
4.3L V6 262 CID	1985-1986	Amarillo, Base, Diablo; High performance	US1121H	5.0L V8 305 CID	1977-1978		US1121
4.3L V6 262 CID	1987	Base, Diablo	US1121	5.0L V8 305 CID	1977-1978	High performance	US1121H
4.3L V6 262 CID	1987	Base, Diablo; High performance	US1121H	5.7L V8 350 CID	1975-1976		US1109
4.4L V8 267 CID	1980	Base, Diablo, Laredo	US1121	5.7L V8 350 CID	1975-1976	High performance	US1109H
4.4L V8 267 CID	1980	Base, Diablo, Laredo; High performance	US1121H	5.7L V8 350 CID	1977-1978		US1121
4.4L V8 267 CID	1981	Amarillo, Base, Conquista, Diablo, Royal Knight	US1121	5.7L V8 350 CID	1977-1978	High performance	US1121H
4.4L V8 267 CID	1981	Amarillo, Base, Conquista, Diablo, Royal Knight; High performance	US1121H	6.6L V8 400 CID	1976		US1109
4.4L V8 267 CID	1982	Amarillo, Base, Diablo	US1121	6.6L V8 400 CID	1976	High performance	US1109H
4.4L V8 267 CID	1982	Amarillo, Base, Diablo; High performance	US1121H	<b>G25</b>			
4.4L V8 267 CID	1982	Amarillo, Base, Diablo; High performance	US1121H	4.1L L6 250 CID	1978		US1107
5.0L V8 305 CID	1978-1979		US1121	4.8L L6 292 CID	1975-1977		US1137
5.0L V8 305 CID	1978-1979	High performance	US1121H	4.8L L6 292 CID	1975-1977	High performance	US1137H
5.0L V8 305 CID	1980	Base, Diablo, Laredo	US1121	4.8L L6 292 CID	1978		US5030
5.0L V8 305 CID	1980	Base, Diablo, Laredo; High performance	US1121H	5.0L V8 305 CID	1977-1978		US1121
5.0L V8 305 CID	1981	Amarillo, Base, Conquista, Diablo, Royal Knight	US1121	5.0L V8 305 CID	1977-1978	High performance	US1121H
5.0L V8 305 CID	1981	Amarillo, Base, Conquista, Diablo, Royal Knight; High performance	US1121H	5.7L V8 350 CID	1975-1976		US1109
5.0L V8 305 CID	1982-1986	Amarillo, Base, Diablo	US1121	5.7L V8 350 CID	1975-1976	High performance	US1109H
5.0L V8 305 CID	1982-1986	Amarillo, Base, Diablo; High performance	US1121H	5.7L V8 350 CID	1977-1978		US1121
5.0L V8 305 CID	1987	Base, Diablo	US1121	5.7L V8 350 CID	1977-1978	High performance	US1121H
5.0L V8 305 CID	1987	Base, Diablo; High performance	US1121H	6.6L V8 400 CID	1975-1976		US1109
5.7L V8 350 CID	1978-1979		US1121	6.6L V8 400 CID	1975-1976	High performance	US1109H
5.7L V8 350 CID	1978-1979	High performance	US1121H	6.6L V8 400 CID	1977-1978		US1121
5.7L V8 350 CID	1983-1984	Amarillo, Base, Diablo	US1120	6.6L V8 400 CID	1977-1978	High performance	US1121H
5.7L V8 350 CID	1983-1984	Amarillo, Base, Diablo; High performance	US1120H	<b>G35</b>			
<b>CANYON</b>				4.8L L6 292 CID	1975-1977		US1137
2.5L L4 2457cc 153 CID	2015	Base, SL, SLE, SLT	US8102	4.8L L6 292 CID	1975-1977	High performance	US1137H
2.5L L4 2457cc 153 CID	2015	Base, SL, SLE, SLT; Pump only	US8102	4.8L L6 292 CID	1978		US5030
2.5L L4 2457cc 153 CID	2016-2017	Base, SL, SLE	US8102	5.7L V8 350 CID	1975-1976		US1109
2.8L L4 171 CID	2016	SLE, SLT	US8154	5.7L V8 350 CID	1975-1976	High performance	US1109H
				5.7L V8 350 CID	1977-1978		US1121
				5.7L V8 350 CID	1977-1978	High performance	US1121H
				6.6L V8 400 CID	1975-1976		US1109
				6.6L V8 400 CID	1975-1976	High performance	US1109H

WATER PUMPS



Engine	Years	Application Description	USMW	Engine	Years	Application Description	USMW
<b>GMC (cont'd.)</b>				<b>GMC (cont'd.)</b>			
<b>G35 (cont'd.)</b>				<b>G2500 (cont'd.)</b>			
6.6L V8 400 CID	1977-1978		US1121	5.7L V8 350 CID	1985-1986	Rally, Rally STX, Vandura	US1121
6.6L V8 400 CID	1977-1978	High performance	US1121H	5.7L V8 350 CID	1985-1986	Rally, Rally STX, Vandura; High performance	US1121H
<b>G1500</b>				5.7L V8 350 CID	1987-1995	Rally, Rally STX, Vandura	US5049
4.1L L6 250 CID	1979		US1107	5.7L V8 350 CID	1987-1995	Rally, Rally STX, Vandura; High performance	US5049H
4.1L L6 250 CID	1980-1982	Rally, Rally STX, Vandura	US1107	6.2L V8 379 CID	1983-1984	Rally, Rally Custom, Rally STX, Vandura	US5008
4.1L L6 250 CID	1983-1984	Rally, Rally Custom, Rally STX, Vandura	US1107	6.2L V8 379 CID	1985-1993	Rally, Rally STX, Vandura	US5008
4.3L V6 262 CID	1985-1986	Rally, Rally STX, Vandura	US1121	6.5L V8 395 CID	1994-1995	Rally, Rally STX, Vandura	US5062
4.3L V6 262 CID	1985-1986	Rally, Rally STX, Vandura; High performance	US1121H	6.6L V8 400 CID	1979		US1121
4.3L V6 262 CID	1987-1993	Rally, Rally STX, Vandura	US5049	6.6L V8 400 CID	1979	High performance	US1121H
4.3L V6 262 CID	1987-1993	Rally, Rally STX, Vandura; High performance	US5049H	6.6L V8 400 CID	1980	Rally, Rally STX, Vandura	US1121
4.3L V6 262 CID	1994-1995	Vandura	US5049	6.6L V8 400 CID	1980	Rally, Rally STX, Vandura; High performance	US1121H
4.3L V6 262 CID	1994-1995	Vandura; High performance	US5049H	<b>G3500</b>			
5.0L V8 305 CID	1979		US1121	4.1L L6 250 CID	1979		US1107
5.0L V8 305 CID	1979	High performance	US1121H	4.1L L6 250 CID	1982-1984	Vandura, Vandura Special	US1107
5.0L V8 305 CID	1980-1982	Rally, Rally STX, Vandura	US1121	4.3L V6 262 CID	1985-1986	Vandura, Vandura Special	US1121
5.0L V8 305 CID	1980-1982	Rally, Rally STX, Vandura; High performance	US1121H	4.3L V6 262 CID	1985-1986	Vandura, Vandura Special; High performance	US1121H
5.0L V8 305 CID	1983-1984	Rally, Rally Custom, Rally STX, Vandura	US1121	4.3L V6 262 CID	1987-1995	Vandura, Vandura Special	US5049
5.0L V8 305 CID	1983-1984	Rally, Rally Custom, Rally STX, Vandura; High performance	US1121H	4.3L V6 262 CID	1987-1995	Vandura, Vandura Special; High performance	US5049H
5.0L V8 305 CID	1985-1986	Rally, Rally STX, Vandura	US1121	5.0L V8 305 CID	1981	Vandura, Vandura Special	US1121
5.0L V8 305 CID	1985-1986	Rally, Rally STX, Vandura; High performance	US1121H	5.0L V8 305 CID	1981	Vandura, Vandura Special; High performance	US1121H
5.0L V8 305 CID	1987-1995	Rally, Rally STX, Vandura	US5049	5.7L V8 350 CID	1979		US1121
5.0L V8 305 CID	1987-1995	Rally, Rally STX, Vandura; High performance	US5049H	5.7L V8 350 CID	1979	High performance	US1121H
5.7L V8 350 CID	1979		US1121	5.7L V8 350 CID	1980-1982	Magnavan, Rally, Rally Camper Special, Rally STX, Vandura, Vandura Special	US1121
5.7L V8 350 CID	1979	High performance	US1121H	5.7L V8 350 CID	1980-1982	Magnavan, Rally, Rally Camper Special, Rally STX, Vandura, Vandura Special; High performance	US1121H
5.7L V8 350 CID	1980-1981	Rally, Rally STX, Vandura	US1121	5.7L V8 350 CID	1983-1984	Magnavan, Rally, Rally Camper Special, Rally Custom, Rally STX, Vandura, Vandura Special; High performance	US1121H
5.7L V8 350 CID	1980-1981	Rally, Rally STX, Vandura; High performance	US1121H	5.7L V8 350 CID	1983-1986	Magnavan, Rally, Rally Camper Special, Rally Custom, Rally STX, Vandura, Vandura Special	US1121
5.7L V8 350 CID	1982	Rally, Rally STX	US1121	5.7L V8 350 CID	1985-1986	Magnavan, Rally, Rally Camper Special, Rally STX, Vandura, Vandura Special; High performance	US1121H
5.7L V8 350 CID	1982	Rally, Rally STX; High performance	US1121H	5.7L V8 350 CID	1987-1988	Magnavan, Rally Custom	US1121
5.7L V8 350 CID	1983	Rally	US1121	5.7L V8 350 CID	1987-1988	Magnavan; High performance	US1121H
5.7L V8 350 CID	1983	Rally; High performance	US1121H	5.7L V8 350 CID	1987-1996	Magnavan, Rally, Rally Camper Special, Rally STX, Vandura, Vandura Special	US5049
5.7L V8 350 CID	1984	Rally, Rally Custom, Rally STX	US1121	5.7L V8 350 CID	1987-1996	Magnavan, Rally, Rally Camper Special, Rally STX, Vandura, Vandura Special	US5049H
5.7L V8 350 CID	1984	Rally, Rally Custom, Rally STX; High performance	US1121H	6.2L V8 379 CID	1983-1988	Magnavan, Rally, Rally Camper Special, Rally Custom, Rally STX, Vandura, Vandura Special	US5008
5.7L V8 350 CID	1984	Rally, Rally Custom, Rally STX; High performance	US1121H	6.2L V8 379 CID	1989-1993	Magnavan, Rally, Rally Camper Special, Rally STX, Vandura, Vandura Special	US5008
5.7L V8 350 CID	1985-1986	Rally, Rally STX	US1121	6.5L V8 395 CID	1994	Rally, Rally Camper Special, Rally STX, Vandura, Vandura Special	US5062
5.7L V8 350 CID	1985-1986	Rally, Rally STX; High performance	US1121H	6.5L V8 395 CID	1995-1996	Magnavan, Rally, Rally Camper Special, Rally STX, Vandura, Vandura Special	US5062
5.7L V8 350 CID	1987-1993	Rally, Rally STX	US5049	6.6L V8 400 CID	1979		US1121
5.7L V8 350 CID	1987-1993	Rally, Rally STX; High performance	US5049H	6.6L V8 400 CID	1979	High performance	US1121H
6.6L V8 400 CID	1979		US1121	6.6L V8 400 CID	1980	Magnavan, Rally, Rally Camper Special, Rally STX, Vandura, Vandura Special	US1121
6.6L V8 400 CID	1979	High performance	US1121H	6.6L V8 400 CID	1980	Magnavan, Rally, Rally Camper Special, Rally STX, Vandura, Vandura Special; High performance	US1121H
<b>G2500</b>				6.6L V8 400 CID	1980	Magnavan, Rally, Rally Camper Special, Rally STX, Vandura, Vandura Special	US1121
4.1L L6 250 CID	1979		US1107	6.6L V8 400 CID	1980	Magnavan, Rally, Rally Camper Special, Rally STX, Vandura, Vandura Special; High performance	US1121H
4.1L L6 250 CID	1980-1982	Rally, Rally STX, Vandura	US1107	7.4L V8 454 CID	1988	Magnavan	US5038
4.1L L6 250 CID	1983-1984	Rally, Rally Custom, Rally STX, Vandura	US1107	7.4L V8 454 CID	1988	Magnavan; High performance	US5038H
4.3L V6 262 CID	1985-1986	Rally, Rally STX, Vandura	US1121	7.4L V8 454 CID	1989-1996	Magnavan, Rally, Rally Camper Special, Rally STX, Vandura, Vandura Special	US5038
4.3L V6 262 CID	1985-1986	Rally, Rally STX, Vandura; High performance	US1121H	7.4L V8 454 CID	1989-1996	Magnavan, Rally, Rally Camper Special, Rally STX, Vandura, Vandura Special; High performance	US5038H
4.3L V6 262 CID	1987-1995	Rally, Rally STX, Vandura	US5049	<b>JIMMY</b>			
4.3L V6 262 CID	1987-1995	Rally, Rally STX, Vandura; High performance	US5049H	4.1L L6 250 CID	1975-1977		US1110
5.0L V8 305 CID	1979		US1121	4.1L L6 250 CID	1978-1979		US1107
5.0L V8 305 CID	1979	High performance	US1121H	4.1L L6 250 CID	1980-1982	Base, High Sierra, Sierra Classic, Sierra Grande, Street Coupe	US1107
5.0L V8 305 CID	1980	Rally, Rally STX	US1121	4.3L V6 262 CID	1992	Base, SLE, SLT	US5049
5.0L V8 305 CID	1980	Rally, Rally STX; High performance	US1121H	4.3L V6 262 CID	1992	Base, SLE, SLT; High performance	US5049H
5.0L V8 305 CID	1981-1982	Rally, Rally STX, Vandura	US1121	4.3L V6 262 CID	1993-1994	Base, SLE, SLS, SLT	US5049
5.0L V8 305 CID	1981-1982	Rally, Rally STX, Vandura; High performance	US1121H	4.3L V6 262 CID	1993-1994	Base, SLE, SLS, SLT; High performance	US5049H
5.0L V8 305 CID	1983-1984	Rally, Rally Custom, Rally STX, Vandura	US1121	4.3L V6 262 CID	1995	Base, SL, SLE, SLS, SLT	US5049
5.0L V8 305 CID	1983-1984	Rally, Rally Custom, Rally STX, Vandura; High performance	US1121H	4.3L V6 262 CID	1995	Base, SL, SLE, SLS, SLT; High performance	US5049H
5.0L V8 305 CID	1985-1986	Rally, Rally STX, Vandura	US1121				
5.0L V8 305 CID	1985-1986	Rally, Rally STX, Vandura; High performance	US1121H				
5.0L V8 305 CID	1987-1995	Rally, Rally STX, Vandura	US5049				
5.0L V8 305 CID	1987-1995	Rally, Rally STX, Vandura; High performance	US5049H				
5.7L V8 350 CID	1979		US1121				
5.7L V8 350 CID	1979	High performance	US1121H				
5.7L V8 350 CID	1980-1981	Rally, Rally STX, Vandura	US1121				
5.7L V8 350 CID	1980-1981	Rally, Rally STX, Vandura; High performance	US1121H				
5.7L V8 350 CID	1982	Rally, Rally STX	US1121				
5.7L V8 350 CID	1982	Rally, Rally STX; High performance	US1121H				
5.7L V8 350 CID	1983	Rally, Rally Custom, Rally STX, Vandura	US1121				
5.7L V8 350 CID	1983	Rally, Rally Custom, Rally STX, Vandura; High performance	US1121H				
5.7L V8 350 CID	1984	Rally, Rally Custom, Rally STX	US1121				
5.7L V8 350 CID	1984	Rally, Rally Custom, Rally STX; High performance	US1121H				

Engine	Years	Application Description	USMW	Engine	Years	Application Description	USMW
<b>GMC (cont'd.)</b>				<b>GMC (cont'd.)</b>			
<b>JIMMY (cont'd.)</b>				<b>K15/K1500 SUBURBAN (cont'd.)</b>			
4.3L V6 262 CID	1996	Base, SL, SLE, SLS, SLT	US5077	4.8L L6 4801cc 292 CID	1970-1971		US896
4.3L V6 262 CID	1996	Base, SL, SLE, SLS, SLT; High performance	US5077H	6.5L V8 396 CID	1968		US981
4.3L V6 262 CID	1997	SL, SLE, SLS, SLT	US5077	6.5L V8 6489cc 396 CID	1968-1969		US981
4.3L V6 262 CID	1997	SL, SLE, SLS, SLT; High performance	US5077H	6.6L V8 402 CID	1970-1972		US981
4.3L V6 262 CID	1998-1999	Envoy, SL, SLE, SLS, SLT	US5077	6.6L V8 6588cc 402 CID	1970-1972		US981
4.3L V6 262 CID	1998-1999	Envoy, SL, SLE, SLS, SLT; High performance	US5077H	<b>K15 SUBURBAN</b>			
4.3L V6 262 CID	2000	Diamond Edition, Envoy, SLE, SLS, SLT	US5077	4.1L L6 250 CID	1975-1977		US1110
4.3L V6 262 CID	2000	Diamond Edition, Envoy, SLE, SLS, SLT; High performance	US5077H	4.1L L6 250 CID	1978		US1107
4.3L V6 262 CID	2001	Diamond Edition, SLE, SLS, SLT	US5077	5.0L V8 305 CID	1977-1978	High performance	US1121
4.3L V6 262 CID	2001	Diamond Edition, SLE, SLS, SLT; High performance	US5077H	5.0L V8 305 CID	1977-1978	High performance	US1121H
4.8L L6 292 CID	1973		US896	5.7L V8 350 CID	1975-1976	High performance	US1109
4.8L L6 4786cc 292 CID	1973		US896	5.7L V8 350 CID	1975-1976	High performance	US1109H
4.8L L6 4801cc 292 CID	1970-1974		US896	5.7L V8 350 CID	1977-1978	High performance	US1121
5.0L V8 305 CID	1977-1979		US1121	5.7L V8 350 CID	1977-1978	High performance	US1121H
5.0L V8 305 CID	1977-1979	High performance	US1121H	6.6L V8 400 CID	1975-1976	High performance	US1109
5.0L V8 305 CID	1980-1982	Base, High Sierra, Sierra Classic, Sierra Grande, Street Coupe	US1121	6.6L V8 400 CID	1977-1978	High performance	US1121
5.0L V8 305 CID	1980-1982	Base, High Sierra, Sierra Classic, Sierra Grande, Street Coupe; High performance	US1121H	6.6L V8 400 CID	1977-1978	High performance	US1121H
5.0L V8 305 CID	1983-1985	Base, High Sierra, Sierra Classic	US1121	<b>K25</b>			
5.0L V8 305 CID	1983-1985	Base, High Sierra, Sierra Classic; High performance	US1121H	4.8L L6 292 CID	1975-1977		US1137
5.0L V8 305 CID	1986	Base, Silverado; High performance	US1121H	4.8L L6 292 CID	1975-1977	High performance	US1137H
5.0L V8 305 CID	1986-1987	Base, Sierra Classic	US1121	4.8L L6 292 CID	1978		US5030
5.0L V8 305 CID	1987	Base, Sierra Classic; High performance	US1121H	5.0L V8 305 CID	1977-1978		US1121
5.7L V8 350 CID	1975-1976		US1109	5.0L V8 305 CID	1977-1978	High performance	US1121H
5.7L V8 350 CID	1975-1976	High performance	US1109H	5.7L V8 350 CID	1975-1976	High performance	US1109
5.7L V8 350 CID	1977-1979		US1121	5.7L V8 350 CID	1977-1978	High performance	US1121
5.7L V8 350 CID	1977-1979	High performance	US1121H	5.7L V8 350 CID	1977-1978	High performance	US1121H
5.7L V8 350 CID	1980-1982	Base, High Sierra, Sierra Classic, Sierra Grande, Street Coupe	US1121	6.6L V8 400 CID	1975-1976	High performance	US1109
5.7L V8 350 CID	1980-1982	Base, High Sierra, Sierra Classic, Sierra Grande, Street Coupe; High performance	US1121H	6.6L V8 400 CID	1977-1978	High performance	US1121
5.7L V8 350 CID	1983-1985	Base, High Sierra, Sierra Classic	US1121	6.6L V8 400 CID	1977-1978	High performance	US1121H
5.7L V8 350 CID	1983-1985	Base, High Sierra, Sierra Classic; High performance	US1121H	<b>K25/K2500 PICKUP</b>			
5.7L V8 350 CID	1986	Base, Silverado; High performance	US1121H	4.8L L6 292 CID	1968		US896
5.7L V8 350 CID	1986-1988	Base, Sierra Classic	US1121	4.8L L6 292 CID	1970-1974		US896
5.7L V8 350 CID	1987-1988	Base, Sierra Classic; High performance	US1121H	4.8L L6 4786cc 292 CID	1973-1974		US896
5.7L V8 350 CID	1989-1990	Base, Sierra Classic	US5049	4.8L L6 4801cc 292 CID	1967-1974		US896
5.7L V8 350 CID	1989-1990	Base, Sierra Classic; High performance	US5049H	5.0L V6 5012cc 305 CID	1968-1969		US835
5.7L V8 350 CID	1991	Base	US5049	6.5L V8 396 CID	1968-1969		US981
5.7L V8 350 CID	1991	Base; High performance	US5049H	6.5L V8 6489cc 396 CID	1968-1969		US981
6.2L V8 379 CID	1982	Base, High Sierra, Sierra Classic, Sierra Grande, Street Coupe	US5008	6.6L V8 6588cc 402 CID	1970-1972		US981
6.2L V8 379 CID	1983-1985	Base, High Sierra, Sierra Classic	US5008	<b>K25/K2500 SUBURBAN</b>			
6.2L V8 379 CID	1986-1990	Base, Sierra Classic	US5008	4.8L L6 292 CID	1968-1974		US896
6.2L V8 379 CID	1991	Base	US5008	4.8L L6 4786cc 292 CID	1973-1974		US896
6.6L V8 400 CID	1975-1976		US1109	4.8L L6 4801cc 292 CID	1968-1974		US896
6.6L V8 400 CID	1975-1976	High performance	US1109H	6.5L V8 396 CID	1968		US981
6.6L V8 400 CID	1977-1979		US1121	6.5L V8 6489cc 396 CID	1968-1969		US981
6.6L V8 400 CID	1977-1979	High performance	US1121H	6.6L V8 6588cc 402 CID	1970-1972		US981
<b>K15</b>				<b>K25 SUBURBAN</b>			
4.1L L6 250 CID	1975-1977		US1110	4.8L L6 292 CID	1975-1977		US1137
4.1L L6 250 CID	1978		US1107	4.8L L6 292 CID	1975-1977	High performance	US1137H
5.0L V8 305 CID	1977-1978		US1121	4.8L L6 292 CID	1978		US5030
5.0L V8 305 CID	1977-1978	High performance	US1121H	5.0L V8 305 CID	1977-1978		US1121
5.7L V8 350 CID	1975-1976		US1109	5.0L V8 305 CID	1977-1978	High performance	US1121H
5.7L V8 350 CID	1975-1976	High performance	US1109H	5.7L V8 350 CID	1975-1976	High performance	US1109
5.7L V8 350 CID	1977-1978		US1121	5.7L V8 350 CID	1977-1978	High performance	US1121
5.7L V8 350 CID	1977-1978	High performance	US1121H	5.7L V8 350 CID	1977-1978	High performance	US1121H
6.6L V8 400 CID	1975-1976		US1109	6.6L V8 400 CID	1975-1976	High performance	US1109
6.6L V8 400 CID	1975-1976	High performance	US1109H	6.6L V8 400 CID	1975-1976	High performance	US1109H
6.6L V8 400 CID	1977-1978		US1121	6.6L V8 400 CID	1977-1978	High performance	US1121
6.6L V8 400 CID	1977-1978	High performance	US1121H	6.6L V8 400 CID	1977-1978	High performance	US1121H
<b>K15/K1500 PICKUP</b>				<b>K35</b>			
4.8L L6 292 CID	1968		US896	4.8L L6 292 CID	1977-1978		US5030
4.8L L6 292 CID	1970-1971		US896	5.7L V8 350 CID	1977-1978		US1121
4.8L L6 292 CID	1974		US896	5.7L V8 350 CID	1977-1978	High performance	US1121H
4.8L L6 4801cc 292 CID	1967-1974		US896	6.6L V8 400 CID	1977-1978		US1121
5.0L V6 5012cc 305 CID	1968-1969		US835	6.6L V8 400 CID	1977-1978	High performance	US1121
6.5L V8 396 CID	1968-1969		US981	6.6L V8 400 CID	1977-1978	High performance	US1121H
6.5L V8 6489cc 396 CID	1968-1969		US981	<b>K35/K3500 PICKUP</b>			
6.6L V8 6588cc 402 CID	1970-1972		US981	4.8L L6 292 CID	1968-1974		US896
<b>K15/K1500 SUBURBAN</b>				4.8L L6 4786cc 292 CID	1973-1974		US896
4.8L L6 292 CID	1968		US896	4.8L L6 4801cc 292 CID	1968-1974		US896
4.8L L6 292 CID	1970-1971		US896	6.5L V8 396 CID	1968-1969		US981
4.8L L6 292 CID	1967-1968		US896	6.5L V8 6489cc 396 CID	1968-1969		US981
				6.6L V8 402 CID	1970-1971		US981
				6.6L V8 6588cc 402 CID	1970-1972		US981
				<b>K1500</b>			
				4.1L L6 250 CID	1979		US1107
				4.1L L6 250 CID	1980-1982	Base, High Sierra, Sierra Classic, Sierra Grande	US1107
				4.1L L6 250 CID	1983-1984	Base, High Sierra, Sierra Classic	US1107
				4.3L V6 262 CID	1985-1986	Base, High Sierra, Sierra Classic	US1121

WATER PUMPS

Engine	Years	Application Description	USMWW	Engine	Years	Application Description	USMWW
<b>GMC (cont'd.)</b>				<b>GMC (cont'd.)</b>			
<b>K1500 (cont'd.)</b>				<b>K1500 (cont'd.)</b>			
4.3L V6 262 CID	1985-1986	Base, High Sierra, Sierra Classic; High performance	US1121H	6.5L V8 395 CID	1994	Sierra SL, Sierra SLE, Sierra SLT, Sierra Special	US5062
4.3L V6 262 CID	1988-1992	Sierra, Sierra SLE, Sierra SLX	US5049	6.5L V8 395 CID	1995	Sierra SL, Sierra SLE, Sierra SLS, Sierra SLT, Sierra Special	US5062
4.3L V6 262 CID	1988-1992	Sierra, Sierra SLE, Sierra SLX; High performance	US5049H	6.5L V8 395 CID	1996	Sierra SL, Sierra SLE, Sierra SLT, Sierra Special; Early	US5062
4.3L V6 262 CID	1993	Sierra, Sierra SLE, Sierra SLX, Sierra Sport	US5049	6.5L V8 395 CID	1996	Sierra SL, Sierra SLE, Sierra SLT, Sierra Special; Late	US5074
4.3L V6 262 CID	1993	Sierra, Sierra SLE, Sierra SLX, Sierra Sport; High performance	US5049H	6.5L V8 395 CID	1997	Sierra SL, Sierra SLE, Sierra SLT	US5074
4.3L V6 262 CID	1994	Sierra SL, Sierra SLE, Sierra SLT, Sierra Special	US5049	6.5L V8 395 CID	1998	Sierra SL, Sierra SLE, Sierra SLT, Sierra Special	US5074
4.3L V6 262 CID	1994	Sierra SL, Sierra SLE, Sierra SLT, Sierra Special; High performance	US5049H	6.6L V8 400 CID	1979		US1121
4.3L V6 262 CID	1995	Sierra SL, Sierra SLE, Sierra SLS, Sierra SLT, Sierra Special	US5049	6.6L V8 400 CID	1979	High performance	US1121H
4.3L V6 262 CID	1995	Sierra SL, Sierra SLE, Sierra SLS, Sierra SLT, Sierra Special; High performance	US5049H	6.6L V8 400 CID	1980	Base, High Sierra, Sierra Classic, Sierra Grande	US1121
4.3L V6 262 CID	1995	Sierra SL, Sierra SLE, Sierra SLS, Sierra SLT, Sierra Special; High performance	US5049H	6.6L V8 400 CID	1980	Base, High Sierra, Sierra Classic, Sierra Grande; High performance	US1121H
4.3L V6 262 CID	1996-1998	Sierra SL, Sierra SLE, Sierra SLT, Sierra Special	US5077	7.4L V8 454 CID	1980	Base, High Sierra, Sierra Classic, Sierra Grande	US1002
4.3L V6 262 CID	1996-1998	Sierra SL, Sierra SLE, Sierra SLT, Sierra Special; High performance	US5077H	7.4L V8 454 CID	1980	Base, High Sierra, Sierra Classic, Sierra Grande; High performance	US1002H
4.8L L6 292 CID	1980	Base, High Sierra, Sierra Classic, Sierra Grande	US5030	<b>K1500 SUBURBAN</b>			
5.0L V8 305 CID	1979	High performance	US1121	4.1L L6 250 CID	1979		US1107
5.0L V8 305 CID	1979	High performance	US1121H	4.1L L6 250 CID	1980	Base, High Sierra, Sierra Classic, Sierra Grande	US1107
5.0L V8 305 CID	1981-1982	Base, High Sierra, Sierra Classic, Sierra Grande	US1121	5.0L V8 305 CID	1979		US1121
5.0L V8 305 CID	1981-1982	Base, High Sierra, Sierra Classic, Sierra Grande; High performance	US1121H	5.0L V8 305 CID	1979	High performance	US1121H
5.0L V8 305 CID	1983-1986	Base, High Sierra, Sierra Classic	US1121	5.0L V8 305 CID	1982	Base, High Sierra, Sierra Classic, Sierra Grande	US1121
5.0L V8 305 CID	1983-1986	Base, High Sierra, Sierra Classic; High performance	US1121H	5.0L V8 305 CID	1982	Base, High Sierra, Sierra Classic, Sierra Grande; High performance	US1121H
5.0L V8 305 CID	1988-1992	Sierra, Sierra SLE, Sierra SLX	US5049	5.0L V8 305 CID	1983-1985	Base, High Sierra, Sierra Classic	US1121
5.0L V8 305 CID	1988-1992	Sierra, Sierra SLE, Sierra SLX; High performance	US5049H	5.0L V8 305 CID	1983-1985	Base, High Sierra, Sierra Classic; High performance	US1121H
5.0L V8 305 CID	1993	Sierra, Sierra SLE, Sierra SLX, Sierra Sport	US5049	5.7L V8 350 CID	1979		US1121
5.0L V8 305 CID	1993	Sierra, Sierra SLE, Sierra SLX, Sierra Sport; High performance	US5049H	5.7L V8 350 CID	1979	High performance	US1121H
5.0L V8 305 CID	1994	Sierra SL, Sierra SLE, Sierra SLT, Sierra Special	US5049	5.7L V8 350 CID	1980-1982	Base, High Sierra, Sierra Classic, Sierra Grande	US1121
5.0L V8 305 CID	1994	Sierra SL, Sierra SLE, Sierra SLT, Sierra Special; High performance	US5049H	5.7L V8 350 CID	1980-1982	Base, High Sierra, Sierra Classic, Sierra Grande; High performance	US1121H
5.0L V8 305 CID	1995	Sierra SL, Sierra SLE, Sierra SLS, Sierra SLT, Sierra Special	US5049	5.7L V8 350 CID	1983-1986	Base, High Sierra, Sierra Classic	US1121
5.0L V8 305 CID	1995	Sierra SL, Sierra SLE, Sierra SLS, Sierra SLT, Sierra Special; High performance	US5049H	5.7L V8 350 CID	1983-1986	Base, High Sierra, Sierra Classic; High performance	US1121H
5.0L V8 305 CID	1996-1998	Sierra SL, Sierra SLE, Sierra SLT, Sierra Special	US5077	5.7L V8 350 CID	1992	Base, SLE; 6.9" HUB HEIGHT	US5049
5.0L V8 305 CID	1996-1998	Sierra SL, Sierra SLE, Sierra SLT, Sierra Special; High performance	US5077H	5.7L V8 350 CID	1992	Base, SLE; 6.9" HUB HEIGHT, High performance	US5049H
5.0L V8 305 CID	1999	Sierra SL, Sierra SLE, Sierra SLT	US5077	5.7L V8 350 CID	1992	Base, SLE; 5.8" HUB HEIGHT	US5073
5.0L V8 305 CID	1999	Sierra SL, Sierra SLE, Sierra SLT; High performance	US5077H	5.7L V8 350 CID	1993-1994	Base, SLE	US5049
5.7L V8 350 CID	1979	High performance	US1121	5.7L V8 350 CID	1993-1994	Base, SLE; High performance	US5049H
5.7L V8 350 CID	1979	High performance	US1121H	5.7L V8 350 CID	1995	Base, SLE, SLT	US5049
5.7L V8 350 CID	1980-1982	Base, High Sierra, Sierra Classic, Sierra Grande	US1121	5.7L V8 350 CID	1995	Base, SLE, SLT; High performance	US5049H
5.7L V8 350 CID	1980-1982	Base, High Sierra, Sierra Classic, Sierra Grande; High performance	US1121H	5.7L V8 350 CID	1996-1999	Base, SLE, SLT	US5077
5.7L V8 350 CID	1983-1986	Base, High Sierra, Sierra Classic	US1121	5.7L V8 350 CID	1996-1999	Base, SLE, SLT; High performance	US5077H
5.7L V8 350 CID	1983-1986	Base, High Sierra, Sierra Classic; High performance	US1121H	6.2L V8 379 CID	1982	Base, High Sierra, Sierra Classic, Sierra Grande	US5008
5.7L V8 350 CID	1988-1992	Sierra, Sierra SLE, Sierra SLX	US5049	6.2L V8 379 CID	1983-1986	Base, High Sierra, Sierra Classic	US5008
5.7L V8 350 CID	1988-1992	Sierra, Sierra SLE, Sierra SLX; High performance	US5049H	6.5L V8 395 CID	1995	Base, SLE, SLT	US5062
5.7L V8 350 CID	1993	Sierra, Sierra SLE, Sierra SLX, Sierra Sport	US5049	6.5L V8 395 CID	1996	Base, SLE, SLT; Early	US5062
5.7L V8 350 CID	1993	Sierra, Sierra SLE, Sierra SLX, Sierra Sport; High performance	US5049H	6.5L V8 395 CID	1996	Base, SLE, SLT; Late	US5074
5.7L V8 350 CID	1994	Sierra SL, Sierra SLE, Sierra SLT, Sierra Special	US5049	6.5L V8 395 CID	1997-1998	Base, SLE, SLT	US5074
5.7L V8 350 CID	1994	Sierra SL, Sierra SLE, Sierra SLT, Sierra Special; High performance	US5049H	6.5L V8 395 CID	1999	Base, SLE, SLT; Bolt on pulley	US5074
5.7L V8 350 CID	1995	Sierra SL, Sierra SLE, Sierra SLS, Sierra SLT, Sierra Special	US5049	6.5L V8 395 CID	1999	Base, SLE, SLT	US5086
5.7L V8 350 CID	1995	Sierra SL, Sierra SLE, Sierra SLS, Sierra SLT, Sierra Special; High performance	US5049H	6.6L V8 400 CID	1979		US1121
5.7L V8 350 CID	1996-1998	Sierra SL, Sierra SLE, Sierra SLT, Sierra Special	US5077	6.6L V8 400 CID	1979	High performance	US1121H
5.7L V8 350 CID	1996-1998	Sierra SL, Sierra SLE, Sierra SLT, Sierra Special; High performance	US5077H	<b>K2500</b>			
5.7L V8 350 CID	1999	Sierra SL, Sierra SLE, Sierra SLT	US5077	4.1L L6 250 CID	1980	Base, High Sierra, Sierra Classic, Sierra Grande	US1107
5.7L V8 350 CID	1999	Sierra SL, Sierra SLE, Sierra SLT; High performance	US5077H	4.3L V6 262 CID	1985	Base, High Sierra, Sierra Classic	US1121
6.2L V8 379 CID	1982	Base, High Sierra, Sierra Classic, Sierra Grande	US5008	4.3L V6 262 CID	1985	Base, High Sierra, Sierra Classic; High performance	US1121H
6.2L V8 379 CID	1983-1986	Base, High Sierra, Sierra Classic	US5008	4.3L V6 262 CID	1988-1993	Sierra, Sierra SLE, Sierra SLX	US5049
6.2L V8 379 CID	1988-1992	Sierra, Sierra SLE, Sierra SLX	US5062	4.3L V6 262 CID	1988-1993	Sierra, Sierra SLE, Sierra SLX; High performance	US5049H
6.2L V8 379 CID	1993	Sierra, Sierra SLE, Sierra SLX, Sierra Sport	US5062	4.3L V6 262 CID	1994-1995	Sierra SL, Sierra SLE	US5049
				4.3L V6 262 CID	1994-1995	Sierra SL, Sierra SLE; High performance	US5049H
				4.8L L6 292 CID	1979		US5030
				4.8L L6 292 CID	1980-1982	Base, High Sierra, Sierra Classic, Sierra Grande	US5030
				4.8L L6 292 CID	1983-1986	Base, High Sierra, Sierra Classic	US5030
				5.0L V8 305 CID	1988-1993	Sierra, Sierra SLE, Sierra SLX	US5049
				5.0L V8 305 CID	1988-1993	Sierra, Sierra SLE, Sierra SLX; High performance	US5049H
				5.0L V8 305 CID	1994-1995	Sierra SL, Sierra SLE, Sierra SLT	US5049
				5.0L V8 305 CID	1994-1995	Sierra SL, Sierra SLE, Sierra SLT; High performance	US5049H
				5.0L V8 305 CID	1998	Sierra SL, Sierra SLE, Sierra SLT	US5077
				5.0L V8 305 CID	1998	Sierra SL, Sierra SLE, Sierra SLT; High performance	US5077H
				5.7L V8 350 CID	1979		US1121



Engine	Years	Application Description	USMW	Engine	Years	Application Description	USMW
<b>GMC (cont'd.)</b>				<b>GMC (cont'd.)</b>			
<b>K2500 (cont'd.)</b>				<b>K3500 (cont'd.)</b>			
5.7L V8 350 CID	1979	High performance	US1121H	4.8L L6 292 CID	1980-1982	Base, High Sierra, Sierra Classic, Sierra Grande	US5030
5.7L V8 350 CID	1980-1982	Base, High Sierra, Sierra Classic, Sierra Grande	US1121	4.8L L6 292 CID	1983-1986	Base, High Sierra, Sierra Classic	US5030
5.7L V8 350 CID	1980-1982	Base, High Sierra, Sierra Classic, Sierra Grande; High performance	US1121H	5.7L V8 350 CID	1979	High performance	US1121H
5.7L V8 350 CID	1983-1986	Base, High Sierra, Sierra Classic	US1121	5.7L V8 350 CID	1979	High performance	US1121H
5.7L V8 350 CID	1983-1986	Base, High Sierra, Sierra Classic; High performance	US1121H	5.7L V8 350 CID	1980-1982	Base, High Sierra, Sierra Classic, Sierra Grande	US1121
5.7L V8 350 CID	1988-1993	Sierra, Sierra SLE, Sierra SLX	US5049	5.7L V8 350 CID	1980-1982	Base, High Sierra, Sierra Classic, Sierra Grande; High performance	US1121H
5.7L V8 350 CID	1988-1993	Sierra, Sierra SLE, Sierra SLX; High performance	US5049H	5.7L V8 350 CID	1983-1986	Base, High Sierra, Sierra Classic	US1121
5.7L V8 350 CID	1994-1995	Sierra SL, Sierra SLE, Sierra SLT	US5049	5.7L V8 350 CID	1983-1986	Base, High Sierra, Sierra Classic; High performance	US1121H
5.7L V8 350 CID	1994-1995	Sierra SL, Sierra SLE, Sierra SLT; High performance	US5049H	5.7L V8 350 CID	1988-1993	Sierra, Sierra SLE, Sierra SLX	US5049
5.7L V8 350 CID	1996-2000	Sierra SL, Sierra SLE, Sierra SLT	US5077	5.7L V8 350 CID	1988-1993	Sierra, Sierra SLE, Sierra SLX	US5049
5.7L V8 350 CID	1996-2000	Sierra SL, Sierra SLE, Sierra SLT; High performance	US5077H	5.7L V8 350 CID	1994-1995	Sierra SL, Sierra SLE, Sierra SLT	US5049
6.2L V8 379 CID	1982	Base, High Sierra, Sierra Classic, Sierra Grande	US5008	5.7L V8 350 CID	1994-1995	Sierra SL, Sierra SLE, Sierra SLT; High performance	US5049H
6.2L V8 379 CID	1983-1986	Base, High Sierra, Sierra Classic	US5008	5.7L V8 350 CID	1996-2000	Sierra SL, Sierra SLE, Sierra SLT	US5077
6.2L V8 379 CID	1988-1993	Sierra, Sierra SLE, Sierra SLX	US5062	5.7L V8 350 CID	1996-2000	Sierra SL, Sierra SLE, Sierra SLT; High performance	US5077H
6.5L V8 395 CID	1992-1993	Sierra, Sierra SLE, Sierra SLX	US5062	6.2L V8 379 CID	1982	Base, High Sierra, Sierra Classic, Sierra Grande	US5008
6.5L V8 395 CID	1994-1995	Sierra SL, Sierra SLE, Sierra SLT	US5062	6.2L V8 379 CID	1983-1986	Base, High Sierra, Sierra Classic	US5008
6.5L V8 395 CID	1996	Sierra SL, Sierra SLE, Sierra SLT; 1st Design, Single Thermostat	US5062	6.2L V8 379 CID	1988-1993	Sierra, Sierra SLE, Sierra SLX	US5062
6.5L V8 395 CID	1996	Sierra SL, Sierra SLE, Sierra SLT; 2nd Design, Dual Thermostat	US5074	6.5L V8 395 CID	1992-1993	Sierra, Sierra SLE, Sierra SLX	US5062
6.5L V8 395 CID	1997-1998	Sierra SL, Sierra SLE, Sierra SLT	US5074	6.5L V8 395 CID	1994-1995	Sierra SL, Sierra SLE, Sierra SLT	US5062
6.5L V8 395 CID	1999	Sierra SL, Sierra SLE, Sierra SLT; Bolt on pulley	US5074	6.5L V8 395 CID	1996	Sierra SL, Sierra SLE, Sierra SLT; 1st Design, Single Thermostat	US5062
6.5L V8 395 CID	1999-2000	Sierra SL, Sierra SLE, Sierra SLT	US5086	6.5L V8 395 CID	1996	Sierra SL, Sierra SLE, Sierra SLT; 2nd Design, Dual Thermostat	US5074
6.6L V8 400 CID	1979	High performance	US1121	6.5L V8 395 CID	1997-1998	Sierra SL, Sierra SLE, Sierra SLT	US5074
6.6L V8 400 CID	1979	High performance	US1121H	6.5L V8 395 CID	1999	Sierra SL, Sierra SLE, Sierra SLT; Bolt on pulley	US5074
6.6L V8 400 CID	1980	Base, High Sierra, Sierra Classic, Sierra Grande	US1121	6.5L V8 395 CID	1999-2000	Sierra SL, Sierra SLE, Sierra SLT	US5086
6.6L V8 400 CID	1980	Base, High Sierra, Sierra Classic, Sierra Grande; High performance	US1121H	6.6L V8 400 CID	1979	High performance	US1121
7.4L V8 454 CID	1991-1993	Sierra, Sierra SLE, Sierra SLX	US5038	6.6L V8 400 CID	1979	High performance	US1121H
7.4L V8 454 CID	1991-1993	Sierra, Sierra SLE, Sierra SLX; High performance	US5038H	6.6L V8 400 CID	1980	Base, High Sierra, Sierra Classic, Sierra Grande	US1121
7.4L V8 454 CID	1994-2000	Sierra SL, Sierra SLE, Sierra SLT	US5038	6.6L V8 400 CID	1980	Base, High Sierra, Sierra Classic, Sierra Grande; High performance	US1121H
7.4L V8 454 CID	1994-2000	Sierra SL, Sierra SLE, Sierra SLT; High performance	US5038H	7.4L V8 454 CID	1980-1982	Base, High Sierra, Sierra Classic, Sierra Grande	US1002
<b>K2500 SUBURBAN</b>				<b>MICROBUS</b>			
4.8L L6 292 CID	1979	High performance	US5030	5.7L V8 5700cc 350 CID	1990-1991	Mexican Application	US5049
4.8L L6 292 CID	1980-1982	Base, High Sierra, Sierra Classic, Sierra Grande	US5030	<b>P15</b>			
4.8L L6 292 CID	1984	Base, High Sierra, Sierra Classic	US5030	4.8L L6 292 CID	1975-1978		US5030
5.7L V8 350 CID	1979	High performance	US1121	<b>P15/P1500 VAN</b>			
5.7L V8 350 CID	1979	High performance	US1121H	4.8L L6 292 CID	1967		US896
5.7L V8 350 CID	1980-1982	Base, High Sierra, Sierra Classic, Sierra Grande	US1121	6.6L V8 400 CID	1971-1972		US981
5.7L V8 350 CID	1980-1982	Base, High Sierra, Sierra Classic, Sierra Grande; High performance	US1121H	<b>P25</b>			
5.7L V8 350 CID	1983-1986	Base, High Sierra, Sierra Classic	US1121	4.8L L6 292 CID	1975-1977		US1137
5.7L V8 350 CID	1983-1986	Base, High Sierra, Sierra Classic; High performance	US1121H	4.8L L6 292 CID	1975-1977	High performance	US1137H
5.7L V8 350 CID	1992	Base, SLE; 6.9" HUB HEIGHT	US5049	4.8L L6 292 CID	1978		US5030
5.7L V8 350 CID	1992	Base, SLE; 6.9" HUB HEIGHT, High performance	US5049H	5.7L V8 350 CID	1975-1976		US1109
5.7L V8 350 CID	1992	Base, SLE; 5.8" HUB HEIGHT	US5073	5.7L V8 350 CID	1975-1976	High performance	US1109H
5.7L V8 350 CID	1993-1994	Base, SLE	US5049	5.7L V8 350 CID	1977-1978		US1121
5.7L V8 350 CID	1993-1994	Base, SLE; High performance	US5049H	5.7L V8 350 CID	1977-1978	High performance	US1121H
5.7L V8 350 CID	1995	Base, SLE, SLT	US5049	<b>P25/P2500 VAN</b>			
5.7L V8 350 CID	1995	Base, SLE, SLT; High performance	US5049H	4.8L L6 292 CID	1967-1974		US896
5.7L V8 350 CID	1996-1999	Base, SLE, SLT	US5077	4.8L L6 4786cc 292 CID	1973-1974		US896
5.7L V8 350 CID	1996-1999	Base, SLE, SLT; High performance	US5077H	6.6L V8 400 CID	1971-1972		US981
6.2L V8 379 CID	1982	Base, High Sierra, Sierra Classic, Sierra Grande	US5008	<b>P35</b>			
6.2L V8 379 CID	1983-1986	Base, High Sierra, Sierra Classic	US5008	4.8L L6 292 CID	1975-1977		US1137
6.5L V8 395 CID	1994	Base, SLE	US5062	4.8L L6 292 CID	1975-1977	High performance	US1137H
6.5L V8 395 CID	1995	Base, SLE, SLT	US5062	4.8L L6 292 CID	1978		US5030
6.5L V8 395 CID	1996	Base, SLE, SLT; Early	US5062	5.7L V8 350 CID	1975-1976		US1109
6.5L V8 395 CID	1996	Base, SLE, SLT; Late	US5074	5.7L V8 350 CID	1975-1976	High performance	US1109H
6.5L V8 395 CID	1997-1998	Base, SLE, SLT	US5074	5.7L V8 350 CID	1977-1978		US1121
6.5L V8 395 CID	1999	Base, SLE, SLT; Bolt on pulley	US5074	5.7L V8 350 CID	1977-1978	High performance	US1121H
6.5L V8 395 CID	1999	Base, SLE, SLT	US5086	<b>P35/P3500 VAN</b>			
6.6L V8 400 CID	1979	High performance	US1121	4.8L L6 292 CID	1967-1974		US896
6.6L V8 400 CID	1979	High performance	US1121H	4.8L L6 4786cc 292 CID	1973-1974		US896
6.6L V8 400 CID	1980	Base, High Sierra, Sierra Classic, Sierra Grande	US1121	6.6L V8 400 CID	1971-1972		US981
6.6L V8 400 CID	1980	Base, High Sierra, Sierra Classic, Sierra Grande; High performance	US1121H				
7.4L V8 454 CID	1992-1994	Base, SLE	US5038				
7.4L V8 454 CID	1992-1994	Base, SLE; High performance	US5038H				
7.4L V8 454 CID	1995-1999	Base, SLE, SLT	US5038				
7.4L V8 454 CID	1995-1999	Base, SLE, SLT; High performance	US5038H				
<b>K3500</b>							
4.8L L6 292 CID	1979	High performance	US5030				

WATER PUMPS



# WATER PUMP APPLICATION GUIDE



Engine	Years	Application Description	USMW
<b>GMC (cont'd.)</b>			
<b>P1500</b>			
4.8L L6 292 CID	1979		<b>US5030</b>
4.8L L6 292 CID	1980	Base, Value Van	<b>US5030</b>
<b>P2500</b>			
4.8L L6 292 CID	1979		<b>US5030</b>
4.8L L6 292 CID	1980-1987	Base, Value Van	<b>US5030</b>
4.8L L6 292 CID	1989	Base, Value Van	<b>US5030</b>
5.7L V8 350 CID	1979		<b>US1121</b>
5.7L V8 350 CID	1979	High performance	<b>US1121H</b>
5.7L V8 350 CID	1980-1989	Base, Value Van	<b>US1121</b>
6.2L V8 379 CID	1982-1989	Base, Value Van	<b>US5008</b>
<b>P3500</b>			
4.3L V6 262 CID	1990	Base, Value Van	<b>US1121</b>
4.3L V6 262 CID	1990	Base, Value Van; High performance	<b>US1121H</b>
4.3L V6 262 CID	1991-1995	Base	<b>US1121</b>
4.3L V6 262 CID	1991-1995	Base; High performance	<b>US1121H</b>
4.3L V6 262 CID	1996-1999	Base	<b>US5077</b>
4.3L V6 262 CID	1996-1999	Base; High performance	<b>US5077H</b>
4.8L L6 292 CID	1979		<b>US5030</b>
4.8L L6 292 CID	1980-1989	Base, Value Van	<b>US5030</b>
5.7L V8 350 CID	1979		<b>US1121</b>
5.7L V8 350 CID	1979	High performance	<b>US1121H</b>
5.7L V8 350 CID	1980-1990	Base, Value Van	<b>US1121</b>
5.7L V8 350 CID	1985-1990	Base, Value Van; High performance	<b>US1121H</b>
5.7L V8 350 CID	1991-1995	Base	<b>US1121</b>
5.7L V8 350 CID	1991-1995	Base; High performance	<b>US1121H</b>
5.7L V8 350 CID	1996-1999	Base	<b>US5077</b>
5.7L V8 350 CID	1996-1999	Base; High performance	<b>US5077H</b>
5.7L V8 5700cc 350 CID	1989-1991	Mexican Application	<b>US5049</b>
6.2L V8 379 CID	1982-1990	Base, Value Van	<b>US5008</b>
6.2L V8 379 CID	1991-1993	Base	<b>US5008</b>
6.5L V8 395 CID	1994-1996	Base	<b>US5062</b>
6.5L V8 395 CID	1997-1998	Base	<b>US5074</b>
6.5L V8 395 CID	1999	Base	<b>US5086</b>
7.4L V8 454 CID	1980-1990	Base, Value Van	<b>US1002</b>
7.4L V8 454 CID	1985-1990	Base, Value Van; High performance	<b>US1002H</b>
7.4L V8 454 CID	1991-1999	Base	<b>US1002</b>
7.4L V8 454 CID	1991-1999	Base; High performance	<b>US1002H</b>
<b>P6000</b>			
7.0L V8 6998cc 427 CID	1990	With threaded hub for fan clutch	<b>US5078</b>
7.0L V8 6998cc 427 CID	1990	Without threaded hub	<b>US5084</b>
<b>P6500</b>			
6.0L V8 366 CID	1992-1996	With threaded hub for fan clutch	<b>US5078</b>
7.0L V8 6998cc 427 CID	1992-1996	With threaded hub for fan clutch	<b>US5078</b>
<b>PB15 SERIES</b>			
4.8L L6 4801cc 292 CID	1966		<b>US896</b>
<b>PB25 SERIES</b>			
4.8L L6 4801cc 292 CID	1966		<b>US896</b>
<b>PB1500 SERIES</b>			
4.8L L6 4801cc 292 CID	1965		<b>US896</b>
<b>PB2500 SERIES</b>			
4.8L L6 4801cc 292 CID	1965		<b>US896</b>
<b>R1500</b>			
4.3L V6 262 CID	1987	Base, High Sierra, Sierra Classic	<b>US1121</b>
4.3L V6 262 CID	1987	Base, High Sierra, Sierra Classic; High performance	<b>US1121H</b>
5.0L V8 305 CID	1987	Base, High Sierra, Sierra Classic	<b>US1121</b>
5.0L V8 305 CID	1987	Base, High Sierra, Sierra Classic; High performance	<b>US1121H</b>
5.7L V8 350 CID	1987	Base, High Sierra, Sierra Classic	<b>US1121</b>
5.7L V8 350 CID	1987	Base, High Sierra, Sierra Classic; High performance	<b>US1121H</b>
6.2L V8 379 CID	1987	Base, High Sierra, Sierra Classic	<b>US5008</b>
<b>R1500 SUBURBAN</b>			
5.0L V8 305 CID	1987	Base, High Sierra, Sierra Classic	<b>US1121</b>
5.0L V8 305 CID	1987	Base, High Sierra, Sierra Classic; High performance	<b>US1121H</b>
5.7L V8 350 CID	1987	Base, High Sierra, Sierra Classic	<b>US1121</b>
5.7L V8 350 CID	1987	Base, High Sierra, Sierra Classic; High performance	<b>US1121H</b>
5.7L V8 350 CID	1988	Base, Sierra Classic	<b>US1121</b>
5.7L V8 350 CID	1988	Base, Sierra Classic; High performance	<b>US1121H</b>
5.7L V8 350 CID	1989	Base, Sierra Classic	<b>US5049</b>
5.7L V8 350 CID	1989	Base, Sierra Classic; High performance	<b>US5049H</b>
5.7L V8 350 CID	1990	Base, SLE	<b>US5049</b>
5.7L V8 350 CID	1990	Base, SLE; High performance	<b>US5049H</b>
5.7L V8 350 CID	1991	Base	<b>US5049</b>
5.7L V8 350 CID	1991	Base; High performance	<b>US5049H</b>
6.2L V8 379 CID	1987	Base, High Sierra, Sierra Classic	<b>US5008</b>
6.2L V8 379 CID	1988-1989	Base, Sierra Classic	<b>US5062</b>
6.2L V8 379 CID	1990	Base, SLE	<b>US5062</b>

Engine	Years	Application Description	USMW
<b>GMC (cont'd.)</b>			
<b>R1500 SUBURBAN (cont'd.)</b>			
6.2L V8 379 CID	1991	Base	<b>US5062</b>
<b>R2500</b>			
4.3L V6 262 CID	1987	Base, High Sierra, Sierra Classic	<b>US1121</b>
4.3L V6 262 CID	1987	Base, High Sierra, Sierra Classic; High performance	<b>US1121H</b>
4.8L L6 292 CID	1987-1988	Base, High Sierra, Sierra Classic	<b>US5030</b>
5.0L V8 305 CID	1987	Base, High Sierra, Sierra Classic	<b>US1121</b>
5.0L V8 305 CID	1987	Base, High Sierra, Sierra Classic; High performance	<b>US1121H</b>
5.7L V8 350 CID	1987-1989	Base, High Sierra, Sierra Classic	<b>US1121</b>
5.7L V8 350 CID	1987-1989	Base, High Sierra, Sierra Classic; High performance	<b>US1121H</b>
6.2L V8 379 CID	1987-1989	Base, High Sierra, Sierra Classic	<b>US5008</b>
7.4L V8 454 CID	1987-1989	Base, High Sierra, Sierra Classic	<b>US1002</b>
7.4L V8 454 CID	1987-1989	Base, High Sierra, Sierra Classic; High performance	<b>US1002H</b>
<b>R2500 SUBURBAN</b>			
5.7L V8 350 CID	1987	Base, High Sierra, Sierra Classic	<b>US1121</b>
5.7L V8 350 CID	1987	Base, High Sierra, Sierra Classic; High performance	<b>US1121H</b>
5.7L V8 350 CID	1988	Base, Sierra Classic	<b>US1121</b>
5.7L V8 350 CID	1988	Base, Sierra Classic; High performance	<b>US1121H</b>
5.7L V8 350 CID	1989	Base, Sierra Classic	<b>US5049</b>
5.7L V8 350 CID	1989	Base, Sierra Classic; High performance	<b>US5049H</b>
5.7L V8 350 CID	1990	Base, SLE	<b>US5049</b>
5.7L V8 350 CID	1990	Base, SLE; High performance	<b>US5049H</b>
5.7L V8 350 CID	1991	Base	<b>US5049</b>
5.7L V8 350 CID	1991	Base; High performance	<b>US5049H</b>
6.2L V8 379 CID	1987	Base, High Sierra, Sierra Classic	<b>US5008</b>
6.2L V8 379 CID	1988-1989	Base, Sierra Classic	<b>US5062</b>
6.2L V8 379 CID	1990	Base, SLE	<b>US5062</b>
6.2L V8 379 CID	1991	Base	<b>US5062</b>
7.4L V8 454 CID	1987	Base, High Sierra, Sierra Classic	<b>US1002</b>
7.4L V8 454 CID	1987	Base, High Sierra, Sierra Classic; High performance	<b>US1002H</b>
7.4L V8 454 CID	1988	Base, Sierra Classic	<b>US1002</b>
7.4L V8 454 CID	1988	Base, Sierra Classic; High performance	<b>US1002H</b>
7.4L V8 454 CID	1989	Base, Sierra Classic	<b>US5038</b>
7.4L V8 454 CID	1989	Base, Sierra Classic; High performance	<b>US5038H</b>
7.4L V8 454 CID	1990	Base, SLE	<b>US5038</b>
7.4L V8 454 CID	1990	Base, SLE; High performance	<b>US5038H</b>
7.4L V8 454 CID	1991	Base	<b>US5038</b>
7.4L V8 454 CID	1991	Base; High performance	<b>US5038H</b>
<b>R3500</b>			
4.8L L6 292 CID	1987-1988	Base, High Sierra, Sierra Classic	<b>US5030</b>
5.7L V8 350 CID	1987-1989	Base, High Sierra, Sierra Classic	<b>US1121</b>
5.7L V8 350 CID	1987-1989	Base, High Sierra, Sierra Classic; High performance	<b>US1121H</b>
5.7L V8 350 CID	1990-1991	Base, SLE	<b>US1121</b>
5.7L V8 350 CID	1990-1991	Base, SLE; High performance	<b>US1121H</b>
6.2L V8 379 CID	1987-1989	Base, High Sierra, Sierra Classic	<b>US5008</b>
6.2L V8 379 CID	1990-1991	Base, SLE	<b>US5008</b>
7.4L V8 454 CID	1987-1989	Base, High Sierra, Sierra Classic	<b>US1002</b>
7.4L V8 454 CID	1987-1989	Base, High Sierra, Sierra Classic; High performance	<b>US1002H</b>
7.4L V8 454 CID	1990-1991	Base, SLE	<b>US1002</b>
7.4L V8 454 CID	1990-1991	Base, SLE; High performance	<b>US1002H</b>
<b>S15</b>			
1.9L L4 119 CID	1982	Base, High Sierra, Sierra Classic, Sierra Grande	<b>US5013</b>
1.9L L4 119 CID	1983-1985	Base, High Sierra, Sierra Classic	<b>US5013</b>
2.0L L4 122 CID	1983-1984	Base, High Sierra, Sierra Classic	<b>US5015</b>
2.5L L4 2474cc 151 CID	1985	Base, High Sierra, Sierra Classic	<b>US5022</b>
2.5L L4 2474cc 151 CID	1986	Base, Gypsy, High Sierra, Sierra Classic	<b>US5022</b>
2.5L L4 2474cc 151 CID	1987	Base, EL, Gypsy, High Sierra, Sierra Classic	<b>US5040</b>
2.5L L4 2474cc 151 CID	1988	Base, Gypsy, High Sierra, Sierra Classic	<b>US5040</b>
2.5L L4 2474cc 151 CID	1989-1990	Base, High Sierra, Sierra Classic	<b>US5040</b>
2.8L V6 173 CID	1982	Base, High Sierra, Sierra Classic, Sierra Grande	<b>US5006</b>
2.8L V6 173 CID	1983-1985	Base, High Sierra, Sierra Classic	<b>US5006</b>
2.8L V6 173 CID	1986	Base, Gypsy, High Sierra, Sierra Classic	<b>US5006</b>
2.8L V6 173 CID	1987	Base, EL, Gypsy, High Sierra, Sierra Classic	<b>US5035</b>
2.8L V6 173 CID	1988	Base, Gypsy, High Sierra, Sierra Classic	<b>US5035</b>
2.8L V6 173 CID	1989-1990	Base, High Sierra, Sierra Classic	<b>US5035</b>
4.3L V6 262 CID	1988	Base, Gypsy, High Sierra, Sierra Classic	<b>US5049</b>
4.3L V6 262 CID	1988	Base, Gypsy, High Sierra, Sierra Classic; High performance	<b>US5049H</b>

Engine	Years	Application Description	USMW	Engine	Years	Application Description	USMW
<b>GMC (cont'd.)</b>				<b>GMC (cont'd.)</b>			
<b>S15 (cont'd.)</b>				<b>SAVANA 1500 (cont'd.)</b>			
4.3L V6 262 CID	1989-1990	Base, High Sierra, Sierra Classic	US5049	5.7L V8 350 CID	1996-2000	Base, SLE; High performance	US5077H
4.3L V6 262 CID	1989-1990	Base, High Sierra, Sierra Classic; High performance	US5049H	5.7L V8 350 CID	2001-2002	Base, SLT	US5077
<b>S15 JIMMY</b>				<b>SAVANA 2500</b>			
1.9L L4 119 CID	1983-1984	Base, Gypsy, Sierra Classic	US5013	2.8L L4 171 CID	2017	Base, LS, LT	US8154
2.0L L4 122 CID	1983-1984	Base, Gypsy, Sierra Classic	US5015	4.3L V6 262 CID	1996-1998	Base; High performance	US5077H
2.5L L4 2474cc 151 CID	1985	Base, Gypsy, High Sierra, Sierra Classic	US5022	4.3L V6 262 CID	1996-2001	Base	US5077
2.5L L4 2474cc 151 CID	1986	Base, Gypsy, Sierra Classic	US5022	4.3L V6 262 CID	1999-2000	Base, SLE; High performance	US5077H
2.5L L4 2474cc 151 CID	1987	Base, Gypsy, Sierra Classic	US5040	4.3L V6 262 CID	2001-2002	Base, SLT; High performance	US5077H
2.5L L4 2474cc 151 CID	1988	Base, Gypsy, Sierra Classic, Timberline	US5040	4.3L V6 262 CID	2002	Base, SLT	US5077
2.8L V6 173 CID	1983-1984	Base, Gypsy, Sierra Classic	US5006	4.3L V6 262 CID	2003	Base	US5077
2.8L V6 173 CID	1985	Base, Gypsy, High Sierra, Sierra Classic	US5006	4.3L V6 262 CID	2003-2005	Base, SLE; High performance	US5077H
2.8L V6 173 CID	1986	Base, Gypsy, Sierra Classic	US5006	4.3L V6 262 CID	2004-2005	Base, SLE	US5077
2.8L V6 173 CID	1987	Base, Gypsy, Sierra Classic	US5035	4.8L V8 294 CID	2003	Base	US64
2.8L V6 173 CID	1988-1989	Base, Gypsy, Sierra Classic, Timberline	US5035	4.8L V8 294 CID	2003	Base; Includes thermostat and thermostat housing	US64-T
4.3L V6 262 CID	1988-1989	Base, Gypsy, Sierra Classic, Timberline	US5049	4.8L V8 294 CID	2004-2005	Base, SLE	US64
4.3L V6 262 CID	1988-1989	Base, Gypsy, Sierra Classic, Timberline; High performance	US5049H	4.8L V8 294 CID	2004-2005	Base, SLE; Includes thermostat and thermostat housing	US64-T
4.3L V6 262 CID	1990	Base, Gypsy, Sierra Classic	US5049	4.8L V8 294 CID	2006	Base	US64
4.3L V6 262 CID	1990	Base, Gypsy, Sierra Classic; High performance	US5049H	4.8L V8 294 CID	2006	Base; Includes thermostat and thermostat housing	US64-T
4.3L V6 262 CID	1991	Base, SLE, SLS, SLT	US5049	4.8L V8 294 CID	2007-2011	Base	US6009
4.3L V6 262 CID	1991	Base, SLE, SLS, SLT; High performance	US5049H	4.8L V8 294 CID	2007-2011	Base; Includes thermostat and thermostat housing	US6009-T
<b>SAFARI</b>				<b>SAVANA 3500</b>			
2.5L L4 2474cc 151 CID	1985	Base, SL, SLE, SLX	US5022	2.8L L4 171 CID	2017	Base, LS, LT	US8154
2.5L L4 2474cc 151 CID	1986	Base	US5022	4.8L V8 294 CID	2004	Base	US64
2.5L L4 2474cc 151 CID	1987-1990	Base	US5040	4.8L V8 294 CID	2004	Base; Includes thermostat and thermostat housing	US64-T
4.3L V6 262 CID	1985-1986	Base, SL, SLE, SLX	US1121	4.8L V8 294 CID	2005	Base, SLE	US64
4.3L V6 262 CID	1985-1986	Base, SL, SLE, SLX; High performance	US1121H	4.8L V8 294 CID	2005	Base, SLE; Includes thermostat and thermostat housing	US64-T
4.3L V6 262 CID	1987	Base, SL, SLE, SLT, SLX	US5049	4.8L V8 294 CID	2006	Base	US64
4.3L V6 262 CID	1987	Base, SL, SLE, SLT, SLX; High performance	US5049H	4.8L V8 294 CID	2006	Base; Includes thermostat and thermostat housing	US64-T
4.3L V6 262 CID	1988-1990	Base, SLE, SLT, SLX	US5049	6.0L V8 5967cc 364 CID	2003-2005	Base, SLE	US64
4.3L V6 262 CID	1988-1990	Base, SLE, SLT, SLX; High performance	US5049H	6.0L V8 5967cc 364 CID	2003-2005	Base, SLE; Includes thermostat and thermostat housing	US64-T
4.3L V6 262 CID	1991-1992	Base, SLE, SLT	US5049	6.0L V8 5967cc 364 CID	2006	Base	US64
4.3L V6 262 CID	1991-1992	Base, SLE, SLT; High performance	US5049H	6.0L V8 5967cc 364 CID	2006	Base; Includes thermostat and thermostat housing	US64-T
4.3L V6 262 CID	1993	Base, GT, SLE, SLT	US5049	6.0L V8 5967cc 364 CID	2007-2014	Base, LS, LT; Includes thermostat and thermostat housing	US6009-T
4.3L V6 262 CID	1993	Base, GT, SLE, SLT; High performance	US5049H	6.0L V8 5967cc 364 CID	2007-2017	Base, LS, LT	US6009
4.3L V6 262 CID	1994	Base, SLE, SLT, SLX	US5049	6.5L V8 395 CID	1996-1998	Base, SLE	US5074
4.3L V6 262 CID	1994	Base, SLE, SLT, SLX; High performance	US5049H	6.5L V8 395 CID	1999-2000	Base, SLE	US5086
4.3L V6 262 CID	1995	Base, SL, SLE, SLT, SLX	US5049	6.5L V8 395 CID	2001	Base	US5086
4.3L V6 262 CID	1995	Base, SL, SLE, SLT, SLX; High performance	US5049H	6.5L V8 395 CID	2002	Base, SLT	US5086
4.3L V6 262 CID	1996-1997	Base, SL, SLE, SLT, SLX	US5077	6.6L V8 6599cc 403 CID	2006-2016	Base	US72
4.3L V6 262 CID	1996-1997	Base, SL, SLE, SLT, SLX; High performance	US5077H	<b>SAVANA 3500</b>			
4.3L V6 262 CID	1998	SL, SLE, SLT, SLX	US5077	2.8L L4 171 CID	2017	Base, LS, LT	US8154
4.3L V6 262 CID	1998	SL, SLE, SLT, SLX; High performance	US5077H	4.8L V8 294 CID	2004	Base	US64
4.3L V6 262 CID	1999-2002	SL, SLE, SLT	US5077	4.8L V8 294 CID	2004	Base; Includes thermostat and thermostat housing	US64-T
4.3L V6 262 CID	1999-2002	SL, SLE, SLT; High performance	US5077H	4.8L V8 294 CID	2005	Base, SLE	US64
4.3L V6 262 CID	2003-2005	Base, SLE, SLT	US5077	4.8L V8 294 CID	2005	Base, SLE; Includes thermostat and thermostat housing	US64-T
4.3L V6 262 CID	2003-2005	Base, SLE, SLT; High performance	US5077H	4.8L V8 294 CID	2006	Base	US64
<b>SAVANA 1500</b>				4.8L V8 294 CID	2006	Base; Includes thermostat and thermostat housing	US64-T
4.3L V6 262 CID	1996-2000	Base, SLE	US5077	4.8L V8 294 CID	2007-2011	Base	US6009
4.3L V6 262 CID	1996-2000	Base, SLE; High performance	US5077H	4.8L V8 294 CID	2007-2011	Base; Includes thermostat and thermostat housing	US6009-T
4.3L V6 262 CID	2001-2002	Base, SLT	US5077	4.8L V8 294 CID	2012-2014	Base, LS, LT; Includes thermostat and thermostat housing	US6009-T
4.3L V6 262 CID	2001-2002	Base, SLT; High performance	US5077H	4.8L V8 294 CID	2012-2017	Base, LS, LT	US6009
4.3L V6 262 CID	2003-2005	Base, SLE	US5077	5.7L V8 350 CID	1996-2000	Base, SLE	US5077
4.3L V6 262 CID	2003-2005	Base, SLE; High performance	US5077H	5.7L V8 350 CID	1996-2000	Base, SLE; High performance	US5077H
4.3L V6 262 CID	2006	Base, LS, LT	US5077	5.7L V8 350 CID	2001-2002	Base, SLT	US5077
4.3L V6 262 CID	2006	Base, LS, LT; High performance	US5077H	5.7L V8 350 CID	2001-2002	Base, SLT; High performance	US5077H
4.3L V6 262 CID	2007-2011	Base; High performance	US5077H	6.0L V8 5967cc 364 CID	2003-2005	Base, SLE	US64
4.3L V6 262 CID	2007-2012	Base	US5077	6.0L V8 5967cc 364 CID	2003-2005	Base, SLE; Includes thermostat and thermostat housing	US64-T
4.3L V6 262 CID	2014	Base	US5077	6.0L V8 5967cc 364 CID	2006	Base, LS, LT	US64
4.3L V6 4293cc 262 CID	2013	Base	US5077	6.0L V8 5967cc 364 CID	2006	Base, LS, LT; Includes thermostat and thermostat housing	US64-T
5.0L V8 305 CID	1996-2000	Base, SLE	US5077	6.0L V8 5967cc 364 CID	2007-2014	Base, LS, LT; Includes thermostat and thermostat housing	US6009-T
5.0L V8 305 CID	1996-2000	Base, SLE; High performance	US5077H	6.0L V8 5967cc 364 CID	2007-2017	Base, LS, LT	US6009
5.0L V8 305 CID	2001-2002	Base, SLT	US5077	6.5L V8 395 CID	1996-1998	Base, SLE	US5074
5.0L V8 305 CID	2001-2002	Base, SLT; High performance	US5077H	6.5L V8 395 CID	1999-2000	Base, SLE	US5086
5.3L V8 5328cc 325 CID	2003-2005	Base, SLE	US64	6.5L V8 395 CID	2001	Base	US5086
5.3L V8 5328cc 325 CID	2003-2005	Base, SLE; Includes thermostat and thermostat housing	US64-T	6.5L V8 395 CID	2002	Base, SLT	US5086
5.3L V8 5328cc 325 CID	2006	Base, LS, LT	US64	6.6L V8 6599cc 403 CID	2006-2016	Base	US72
5.3L V8 5328cc 325 CID	2006	Base, LS, LT; Includes thermostat and thermostat housing	US64-T	<b>SAVANA 3500</b>			
5.3L V8 5328cc 325 CID	2007-2014	Base, LS, LT	US6009	2.8L L4 171 CID	2017	Base, LS, LT	US8154
5.3L V8 5328cc 325 CID	2007-2014	Base, LS, LT; Includes thermostat and thermostat housing	US6009-T	4.8L V8 294 CID	2004	Base	US64
5.7L V8 350 CID	1996-2000	Base, SLE	US5077	4.8L V8 294 CID	2004	Base; Includes thermostat and thermostat housing	US64-T

WATER PUMPS



Engine	Years	Application Description	USMW	Engine	Years	Application Description	USMW
<b>GMC (cont'd.)</b>				<b>GMC (cont'd.)</b>			
<b>SAVANA 3500 (cont'd.)</b>				<b>SIERRA 1500 (cont'd.)</b>			
6.6L V8 6599cc 403 CID	2015-2016	Base, LS, LT	<b>US72</b>	6.0L V8 5967cc 364 CID	2007-2008	SLE, SLT	<b>US6009</b>
7.4L V8 454 CID	1996-2000	Base, SLE	<b>US5038</b>	6.0L V8 5967cc 364 CID	2007-2008	SLE, SLT; Includes thermostat and thermostat housing	<b>US6009-T</b>
7.4L V8 454 CID	1996-2000	Base, SLE; High performance	<b>US5038H</b>	6.0L V8 5967cc 364 CID	2009	Hybrid, SLE, SLT	<b>US6009</b>
8.1L V8 496 CID	2001-2002	Base, SLT	<b>US5090</b>	6.0L V8 5967cc 364 CID	2009	Hybrid, SLE, SLT; Includes thermostat and thermostat housing	<b>US6009-T</b>
<b>SAVANA 4500</b>				<b>SIERRA 1500 CLASSIC</b>			
6.0L V8 5967cc 364 CID	2015-2016	Base	<b>US6009</b>	4.3L V6 262 CID	2007	SL, WT	<b>US5077</b>
6.6L V8 6599cc 403 CID	2009-2014	Base, Medium/Heavy Duty	<b>US72</b>	4.8L V8 294 CID	2007	SL, SLE, WT	<b>US6009</b>
6.6L V8 6599cc 403 CID	2015-2016	Base	<b>US72</b>	4.8L V8 294 CID	2007	SL, SLE, WT; Includes thermostat and thermostat housing	<b>US6009-T</b>
6L V8 5967cc 364 CID	2009-2014	Base, Medium/Heavy Duty	<b>US6009</b>	5.3L V8 5328cc 325 CID	2007	Hybrid, SL, SLE, SLT, WT	<b>US6009</b>
<b>SIERRA</b>				<b>SIERRA 1500 HD CLASSIC</b>			
5.3L V8 5300cc 323 CID	2010-2012	Mexican Application	<b>US6009</b>	4.3L V6 262 CID	2007	SL, SLE, WT; Includes thermostat and thermostat housing	<b>US6009-T</b>
5.3L V8 5300cc 323 CID	2014	Mexican Application	<b>US6009</b>	5.3L V8 5328cc 325 CID	2007	Hybrid, SL, SLE, SLT, WT; Includes thermostat and thermostat housing	<b>US6009-T</b>
<b>SIERRA 1500</b>				<b>SIERRA 1500 HD</b>			
4.3L V6 262 CID	1999-2001	SL, SLE, SLT	<b>US5077</b>	6.0L V8 5967cc 364 CID	2001-2003	SLE, SLT	<b>US64</b>
4.3L V6 262 CID	1999-2001	SL, SLE, SLT; High performance	<b>US5077H</b>	6.0L V8 5967cc 364 CID	2001-2003	SLE, SLT; Includes thermostat and thermostat housing	<b>US64-T</b>
4.3L V6 262 CID	2002	Base, HT, SL, SLE, SLT, WT	<b>US5077</b>	6.0L V8 5967cc 364 CID	2005-2006	SLE, SLT	<b>US64</b>
4.3L V6 262 CID	2002	Base, HT, SL, SLE, SLT, WT; High performance	<b>US5077H</b>	6.0L V8 5967cc 364 CID	2005-2006	SLE, SLT; Includes thermostat and thermostat housing	<b>US64-T</b>
4.3L V6 262 CID	2003	Base, SL, SLE, SLT, WT	<b>US5077</b>	<b>SIERRA 1500 HD CLASSIC</b>			
4.3L V6 262 CID	2003	Base, SL, SLE, SLT, WT; High performance	<b>US5077H</b>	6.0L V8 5967cc 364 CID	2007	SLE, SLT	<b>US6009</b>
4.3L V6 262 CID	2004	Base, SLE, SLT, WT	<b>US5077</b>	6.0L V8 5967cc 364 CID	2007	SLE, SLT; Includes thermostat and thermostat housing	<b>US6009-T</b>
4.3L V6 262 CID	2004	Base, SLE, SLT, WT; High performance	<b>US5077H</b>	<b>SIERRA 2500</b>			
4.3L V6 262 CID	2005	Base, WT	<b>US5077</b>	5.3L V8 5328cc 325 CID	1999-2000	SL, SLE, SLT	<b>US64</b>
4.3L V6 262 CID	2005	Base, WT; High performance	<b>US5077H</b>	5.3L V8 5328cc 325 CID	1999-2000	SL, SLE, SLT; Includes thermostat and thermostat housing	<b>US64-T</b>
4.3L V6 262 CID	2006	SL, WT	<b>US5077</b>	6.0L V8 5967cc 364 CID	1999-2001	SL, SLE, SLT	<b>US64</b>
4.3L V6 262 CID	2006	SL, WT; High performance	<b>US5077H</b>	6.0L V8 5967cc 364 CID	1999-2001	SL, SLE, SLT; Includes thermostat and thermostat housing	<b>US64-T</b>
4.3L V6 262 CID	2007-2011	WT; High performance	<b>US5077H</b>	6.0L V8 5967cc 364 CID	2002	Base, SL, SLE, SLT	<b>US64</b>
4.3L V6 262 CID	2007-2013	WT	<b>US5077</b>	6.0L V8 5967cc 364 CID	2002	Base, SL, SLE, SLT; Includes thermostat and thermostat housing	<b>US64-T</b>
4.3L V6 262 CID	2014-2017	Base, SLE	<b>US8918</b>	6.0L V8 5967cc 364 CID	2003-2004	Base, SLE, SLT, WT	<b>US64</b>
4.8L V8 294 CID	1999-2001	SL, SLE, SLT	<b>US64</b>	6.0L V8 5967cc 364 CID	2003-2004	Base, SLE, SLT, WT; Includes thermostat and thermostat housing	<b>US64-T</b>
4.8L V8 294 CID	1999-2001	SL, SLE, SLT; Includes thermostat and thermostat housing	<b>US64-T</b>	<b>SIERRA 2500 HD</b>			
4.8L V8 294 CID	2002	Base, HT, SL, SLE, SLT, WT	<b>US64</b>	6.0L V8 5967cc 364 CID	2001	SL, SLE, SLT	<b>US64</b>
4.8L V8 294 CID	2002	Base, HT, SL, SLE, SLT, WT; Includes thermostat and thermostat housing	<b>US64-T</b>	6.0L V8 5967cc 364 CID	2001	SL, SLE, SLT; Includes thermostat and thermostat housing	<b>US64-T</b>
4.8L V8 294 CID	2003	Base, SL, SLE, SLT, WT	<b>US64</b>	6.0L V8 5967cc 364 CID	2002	Base, SL, SLE, SLT	<b>US64</b>
4.8L V8 294 CID	2003	Base, SL, SLE, SLT, WT; Includes thermostat and thermostat housing	<b>US64-T</b>	6.0L V8 5967cc 364 CID	2002	Base, SL, SLE, SLT; Includes thermostat and thermostat housing	<b>US64-T</b>
4.8L V8 294 CID	2004	Base, SLE, SLT, WT	<b>US64</b>	6.0L V8 5967cc 364 CID	2003-2005	Base, SLE, SLT, WT	<b>US64</b>
4.8L V8 294 CID	2004	Base, SLE, SLT, WT; Includes thermostat and thermostat housing	<b>US64-T</b>	6.0L V8 5967cc 364 CID	2003-2005	Base, SLE, SLT, WT; Includes thermostat and thermostat housing	<b>US64-T</b>
4.8L V8 294 CID	2005	Base, SLE, WT	<b>US64</b>	6.0L V8 5967cc 364 CID	2006	SL, SLE, SLT, WT	<b>US64</b>
4.8L V8 294 CID	2005	Base, SLE, WT; Includes thermostat and thermostat housing	<b>US64-T</b>	6.0L V8 5967cc 364 CID	2006	SL, SLE, SLT, WT; Includes thermostat and thermostat housing	<b>US64-T</b>
4.8L V8 294 CID	2006	SL, SLE, WT	<b>US64</b>	6.0L V8 5967cc 364 CID	2007-2010	SLE, SLT, WT	<b>US6009</b>
4.8L V8 294 CID	2006	SL, SLE, WT; Includes thermostat and thermostat housing	<b>US64-T</b>	6.0L V8 5967cc 364 CID	2007-2010	SLE, SLT, WT; Includes thermostat and thermostat housing	<b>US6009-T</b>
4.8L V8 294 CID	2007	SLE, WT	<b>US6009</b>	6.0L V8 5967cc 364 CID	2011-2014	Denali, SLE, SLT, WT	<b>US6009</b>
4.8L V8 294 CID	2007	SLE, WT; Includes thermostat and thermostat housing	<b>US6009-T</b>	6.0L V8 5967cc 364 CID	2011-2014	Denali, SLE, SLT, WT; Includes thermostat and thermostat housing	<b>US6009-T</b>
4.8L V8 294 CID	2008-2013	SL, SLE, WT	<b>US6009</b>	6.0L V8 5967cc 364 CID	2015-2017	Base, Denali, SLE, SLT	<b>US6009</b>
4.8L V8 294 CID	2008-2013	SL, SLE, WT; Includes thermostat and thermostat housing	<b>US6009-T</b>	6.6L V8 6599cc 403 CID	2001	SL, SLE, SLT	<b>US63</b>
5.3L V8 5328cc 325 CID	1999-2001	SL, SLE, SLT	<b>US64</b>	6.6L V8 6599cc 403 CID	2002	Base, SL, SLE, SLT	<b>US63</b>
5.3L V8 5328cc 325 CID	1999-2001	SL, SLE, SLT; Includes thermostat and thermostat housing	<b>US64-T</b>	6.6L V8 6599cc 403 CID	2003-2005	Base, SLE, SLT, WT	<b>US63</b>
5.3L V8 5328cc 325 CID	2002	Base, HT, SL, SLE, SLT, WT	<b>US64</b>	6.6L V8 6599cc 403 CID	2006	SL, SLE, SLT, WT	<b>US72</b>
5.3L V8 5328cc 325 CID	2002	Base, HT, SL, SLE, SLT, WT; Includes thermostat and thermostat housing	<b>US64-T</b>	6.6L V8 6599cc 403 CID	2007-2010	SLE, SLT, WT	<b>US72</b>
5.3L V8 5328cc 325 CID	2003	Base, SL, SLE, SLT, WT	<b>US64</b>	6.6L V8 6599cc 403 CID	2011-2014	Denali, SLE, SLT, WT	<b>US72</b>
5.3L V8 5328cc 325 CID	2003	Base, SL, SLE, SLT, WT; Includes thermostat and thermostat housing	<b>US64-T</b>	6.6L V8 6599cc 403 CID	2015-2016	Base, Denali, SLE, SLT	<b>US72</b>
5.3L V8 5328cc 325 CID	2004	Base, SLE, SLT, WT	<b>US64</b>	6.6L V8 6599cc 403 CID	2017	Base, Denali, SLE, SLT	<b>US310</b>
5.3L V8 5328cc 325 CID	2004	Base, SLE, SLT, WT; Includes thermostat and thermostat housing	<b>US64-T</b>	8.1L V8 496 CID	2001	SL, SLE, SLT	<b>US5089</b>
5.3L V8 5328cc 325 CID	2005	Base, Hybrid, SLE, SLT, WT	<b>US64</b>	8.1L V8 496 CID	2001	SL, SLE, SLT; High performance	<b>US5089H</b>
5.3L V8 5328cc 325 CID	2005	Base, Hybrid, SLE, SLT, WT; Includes thermostat and thermostat housing	<b>US64-T</b>	8.1L V8 496 CID	2002	Base, SL, SLE, SLT	<b>US5089</b>
5.3L V8 5328cc 325 CID	2006	Hybrid, SL, SLE, SLT, WT	<b>US64</b>	8.1L V8 496 CID	2002	Base, SL, SLE, SLT; High performance	<b>US5089H</b>
5.3L V8 5328cc 325 CID	2006	Hybrid, SL, SLE, SLT, WT; Includes thermostat and thermostat housing	<b>US64-T</b>	8.1L V8 496 CID	2003-2005	Base, SLE, SLT, WT	<b>US5089</b>
5.3L V8 5328cc 325 CID	2007-2009	SLE, SLT, WT	<b>US6009</b>				
5.3L V8 5328cc 325 CID	2007-2009	SLE, SLT, WT; Includes thermostat and thermostat housing	<b>US6009-T</b>				
5.3L V8 5328cc 325 CID	2010-2013	SL, SLE, SLT, WT, XFE	<b>US6009</b>				
5.3L V8 5328cc 325 CID	2010-2013	SL, SLE, SLT, WT, XFE; Includes thermostat and thermostat housing	<b>US6009-T</b>				
5.3L V8 5328cc 325 CID	2014-2017	Base, Denali, SLE, SLT	<b>US8918</b>				
6.0L V8 5967cc 364 CID	2001	C3	<b>US64</b>				
6.0L V8 5967cc 364 CID	2001	C3; Includes thermostat and thermostat housing	<b>US64-T</b>				
6.0L V8 5967cc 364 CID	2002-2004	Denali	<b>US64</b>				
6.0L V8 5967cc 364 CID	2002-2004	Denali; Includes thermostat and thermostat housing	<b>US64-T</b>				
6.0L V8 5967cc 364 CID	2005-2006	Denali, SLE, SLT	<b>US64</b>				
6.0L V8 5967cc 364 CID	2005-2006	Denali, SLE, SLT; Includes thermostat and thermostat housing	<b>US64-T</b>				

Engine	Years	Application Description	USMW	Engine	Years	Application Description	USMW
<b>GMC (cont'd.)</b>				<b>GMC (cont'd.)</b>			
<b>SIERRA 2500 HD (cont'd.)</b>				<b>SPRINT (cont'd.)</b>			
8.1L V8 496 CID	2003-2005	Base, SLE, SLT, WT; High performance	US5089H	5.0L V8 305 CID	1977		US1121
8.1L V8 496 CID	2006	SL, SLE, SLT, WT	US5089	5.0L V8 305 CID	1977	High performance	US1121H
8.1L V8 496 CID	2006	SL, SLE, SLT, WT; High performance	US5089H	5.7L V8 350 CID	1977		US1121
<b>SIERRA 2500 HD CLASSIC</b>				<b>SUBURBAN</b>			
6.0L V8 5967cc 364 CID	2007	SL, SLE, SLT, WT	US6009	4.8L L6 4801cc 292 CID	1965-1966		US896
6.0L V8 5967cc 364 CID	2007	SL, SLE, SLT, WT; Includes thermostat and thermostat housing	US6009-T	<b>SYCLONE</b>			
6.6L V8 6599cc 403 CID	2007	SL, SLE, SLT, WT	US72	4.3L V6 262 CID	1991	Base	US5049
8.1L V8 496 CID	2007	SL, SLE, SLT, WT	US5089	4.3L V6 262 CID	1991	Base; High performance	US5049H
8.1L V8 496 CID	2007	SL, SLE, SLT, WT; High performance	US5089H	<b>T6500</b>			
<b>SIERRA 3500</b>				<b>T7500</b>			
6.0L V8 5967cc 364 CID	2001	SL, SLE, SLT	US64	6.0L V8 366 CID	1997-1998	With threaded hub for fan clutch	US5078
6.0L V8 5967cc 364 CID	2001	SL, SLE, SLT; Includes thermostat and thermostat housing	US64-T	7.8L L6 475 CID	2000-2002	8 vane impeller, Medium/Heavy Duty	US73
6.0L V8 5967cc 364 CID	2002	Base, SL, SLE, SLT	US64	<b>TERRAIN</b>			
6.0L V8 5967cc 364 CID	2002	Base, SL, SLE, SLT; Includes thermostat and thermostat housing	US64-T	2.4L L4 2384cc 145 CID	2010-2012	SLE, SLT	US5092
6.0L V8 5967cc 364 CID	2003	Base, SLE, SLT	US64	2.4L L4 2384cc 145 CID	2013-2014	Denali, SLE, SLT	US5092
6.0L V8 5967cc 364 CID	2003	Base, SLE, SLT; Includes thermostat and thermostat housing	US64-T	2.4L L4 2384cc 145 CID	2015-2017	Denali, SL, SLE, SLT	US5092
6.0L V8 5967cc 364 CID	2004-2005	Base, SLE, SLT, WT	US64	3.0L V6 182 CID	2010-2012	SLE, SLT	US8932
6.0L V8 5967cc 364 CID	2004-2005	Base, SLE, SLT, WT; Includes thermostat and thermostat housing	US64-T	3.0L V6 2994cc 183 CID	2011-2012	Mexican Application	US8932
6.0L V8 5967cc 364 CID	2006	SL, SLE, SLT, WT	US64	3.6L V6 3564cc 217 CID	2013	Denali, SLE, SLT	US8932
6.0L V8 5967cc 364 CID	2006	SL, SLE, SLT, WT; Includes thermostat and thermostat housing	US64-T	3.6L V6 3564cc 217 CID	2013	Mexican Application	US8932
6.6L V8 6599cc 403 CID	2001	SL, SLE, SLT	US63	3.6L V6 3564cc 217 CID	2015-2017	Denali, SLE, SLT	US8932
6.6L V8 6599cc 403 CID	2002	Base, SL, SLE, SLT	US63	<b>TYPHOON</b>			
6.6L V8 6599cc 403 CID	2003	Base, SLE, SLT	US63	4.3L V6 262 CID	1992-1993	Base	US5049
6.6L V8 6599cc 403 CID	2004-2005	Base, SLE, SLT, WT	US63	4.3L V6 262 CID	1992-1993	Base; High performance	US5049H
6.6L V8 6599cc 403 CID	2006	SL, SLE, SLT, WT	US72	<b>V1500</b>			
8.1L V8 496 CID	2001	SL, SLE, SLT	US5089	4.3L V6 262 CID	1987	Base, High Sierra, Sierra Classic	US1121
8.1L V8 496 CID	2001	SL, SLE, SLT; High performance	US5089H	4.3L V6 262 CID	1987	Base, High Sierra, Sierra Classic; High performance	US1121H
8.1L V8 496 CID	2002	Base, SL, SLE, SLT	US5089	5.0L V8 305 CID	1987	Base, High Sierra, Sierra Classic	US1121
8.1L V8 496 CID	2002	Base, SL, SLE, SLT; High performance	US5089H	5.0L V8 305 CID	1987	Base, High Sierra, Sierra Classic; High performance	US1121H
8.1L V8 496 CID	2003	Base, SLE, SLT	US5089	5.7L V8 350 CID	1987	Base, High Sierra, Sierra Classic	US1121
8.1L V8 496 CID	2003	Base, SLE, SLT; High performance	US5089H	5.7L V8 350 CID	1987	Base, High Sierra, Sierra Classic; High performance	US1121H
8.1L V8 496 CID	2004-2005	Base, SLE, SLT, WT	US5089	6.2L V8 379 CID	1987	Base, High Sierra, Sierra Classic	US5008
8.1L V8 496 CID	2004-2005	Base, SLE, SLT, WT; High performance	US5089H	<b>V1500 SUBURBAN</b>			
8.1L V8 496 CID	2006	SL, SLE, SLT, WT	US5089	5.7L V8 350 CID	1987	Base, High Sierra, Sierra Classic	US1121
8.1L V8 496 CID	2006	SL, SLE, SLT, WT; High performance	US5089H	5.7L V8 350 CID	1987	Base, High Sierra, Sierra Classic; High performance	US1121H
<b>SIERRA 3500 CLASSIC</b>				5.7L V8 350 CID	1988	Base, Sierra Classic	US1121
6.0L V8 5967cc 364 CID	2007	SL, SLE, SLT, WT	US6009	5.7L V8 350 CID	1988	Base, Sierra Classic; High performance	US1121H
6.0L V8 5967cc 364 CID	2007	SL, SLE, SLT, WT; Includes thermostat and thermostat housing	US6009-T	5.7L V8 350 CID	1989	Base, Sierra Classic	US5049
6.6L V8 6599cc 403 CID	2007	SL, SLE, SLT, WT	US72	5.7L V8 350 CID	1989	Base, Sierra Classic; High performance	US5049H
8.1L V8 496 CID	2007	SL, SLE, SLT, WT	US5089	5.7L V8 350 CID	1990	Base, SLE	US5049
8.1L V8 496 CID	2007	SL, SLE, SLT, WT; High performance	US5089H	5.7L V8 350 CID	1990	Base, SLE; High performance	US5049H
<b>SIERRA 3500 HD</b>				5.7L V8 350 CID	1991	Base	US5049
6.0L V8 5967cc 364 CID	2007-2010	SLE, SLT, WT	US6009	5.7L V8 350 CID	1991	Base; High performance	US5049H
6.0L V8 5967cc 364 CID	2007-2010	SLE, SLT, WT; Includes thermostat and thermostat housing	US6009-T	6.2L V8 379 CID	1987	Base, High Sierra, Sierra Classic	US5008
6.0L V8 5967cc 364 CID	2011-2014	Denali, SLE, SLT, WT	US6009	6.2L V8 379 CID	1988-1989	Base, Sierra Classic	US5062
6.0L V8 5967cc 364 CID	2011-2014	Denali, SLE, SLT, WT; Includes thermostat and thermostat housing	US6009-T	6.2L V8 379 CID	1990	Base, SLE	US5062
6.0L V8 5967cc 364 CID	2015-2017	Base, Denali, SLE, SLT	US6009	6.2L V8 379 CID	1991	Base	US5062
6.6L V8 6599cc 403 CID	2007-2010	SLE, SLT, WT	US72	<b>V2500</b>			
6.6L V8 6599cc 403 CID	2011-2014	Denali, SLE, SLT, WT	US72	4.8L L6 292 CID	1987	Base, High Sierra, Sierra Classic	US5030
6.6L V8 6599cc 403 CID	2015-2016	Base, Denali, SLE, SLT	US72	5.7L V8 350 CID	1987	Base, High Sierra, Sierra Classic	US1121
6.6L V8 6599cc 403 CID	2017	Base, Denali, SLE, SLT	US310	5.7L V8 350 CID	1987	Base, High Sierra, Sierra Classic; High performance	US1121H
<b>SONOMA</b>				6.2L V8 379 CID	1987	Base, High Sierra, Sierra Classic	US5008
2.2L L4 2190cc 134 CID	1994-2001	SL, SLE, SLS	US5032	<b>V2500 SUBURBAN</b>			
2.2L L4 2190cc 134 CID	2002-2003	SL, SLS	US5032	5.7L V8 350 CID	1987	Base, High Sierra, Sierra Classic	US1121
2.5L L4 2474cc 151 CID	1991-1992	Base, SLE	US5040	5.7L V8 350 CID	1987	Base, High Sierra, Sierra Classic; High performance	US1121H
2.5L L4 2474cc 151 CID	1993	Base, SLE, SLS	US5040	5.7L V8 350 CID	1988	Base, Sierra Classic	US1121
2.8L V6 173 CID	1991	Base, SLE	US5035	5.7L V8 350 CID	1988	Base, Sierra Classic; High performance	US1121H
2.8L V6 173 CID	1992	Base, GT, SLE	US5035	5.7L V8 350 CID	1989	Base, Sierra Classic	US5049
2.8L V6 173 CID	1993	Base, SLE, SLS	US5035	5.7L V8 350 CID	1989	Base, Sierra Classic; High performance	US5049H
4.3L V6 262 CID	1991	Base, SLE	US5049	5.7L V8 350 CID	1990	Base, SLE	US5049
4.3L V6 262 CID	1991	Base, SLE; High performance	US5049H	5.7L V8 350 CID	1990	Base, SLE; High performance	US5049H
4.3L V6 262 CID	1992	Base, GT, SLE	US5049	5.7L V8 350 CID	1991	Base	US5049
4.3L V6 262 CID	1992	Base, GT, SLE; High performance	US5049H	5.7L V8 350 CID	1991	Base; High performance	US5049H
4.3L V6 262 CID	1993	Base, SLE, SLS	US5049	6.2L V8 379 CID	1987	Base, High Sierra, Sierra Classic	US5008
4.3L V6 262 CID	1993	Base, SLE, SLS; High performance	US5049H	6.2L V8 379 CID	1988-1989	Base, Sierra Classic	US5062
4.3L V6 262 CID	1994-1995	SL, SLE, SLS	US5049	6.2L V8 379 CID	1990	Base, SLE	US5062
4.3L V6 262 CID	1994-1995	SL, SLE, SLS; High performance	US5049H	6.2L V8 379 CID	1991	Base	US5062
4.3L V6 262 CID	1996-2000	SL, SLE, SLS; High performance	US5077H	<b>V3500</b>			
4.3L V6 262 CID	1996-2001	SL, SLE, SLS	US5077	4.8L L6 292 CID	1987-1988	Base, High Sierra, Sierra Classic	US5030
4.3L V6 262 CID	2001-2004	SL, SLS; High performance	US5077H				
4.3L V6 262 CID	2002-2004	SL, SLS	US5077				
<b>SPRINT</b>							
4.1L L6 250 CID	1975		US895				
4.1L L6 250 CID	1977		US1107				

WATER PUMPS



Engine	Years	Application Description	USMW	Engine	Years	Application Description	USMW
<b>GMC (cont'd.)</b>				<b>GMC (cont'd.)</b>			
<b>V3500 (cont'd.)</b>				<b>YUKON XL 1500 (cont'd.)</b>			
5.7L V8 350 CID	1987-1989	Base, High Sierra, Sierra Classic	US1121	6.0L V8 5967cc 364 CID	2001-2006	Denali; Includes thermostat and thermostat housing	US64-T
5.7L V8 350 CID	1987-1989	Base, High Sierra, Sierra Classic; High performance	US1121H	6.0L V8 5967cc 364 CID	2007-2009	SLE, SLT	US6009
5.7L V8 350 CID	1990-1991	Base, SLE	US1121	6.0L V8 5967cc 364 CID	2007-2009	SLE, SLT; Includes thermostat and thermostat housing	US6009-T
5.7L V8 350 CID	1990-1991	Base, SLE; High performance	US1121H	6.2L V8 6162cc 376 CID	2007-2009	Denali	US6009
6.2L V8 379 CID	1987-1989	Base, High Sierra, Sierra Classic	US5008	6.2L V8 6162cc 376 CID	2007-2009	Denali; Includes thermostat and thermostat housing	US6009-T
6.2L V8 379 CID	1990-1991	Base, SLE	US5008	6.2L V8 6162cc 376 CID	2010-2014	Denali, SLT	US6009
7.4L V8 454 CID	1987-1989	Base, High Sierra, Sierra Classic	US1002	6.2L V8 6162cc 376 CID	2010-2014	Denali, SLT; Includes thermostat and thermostat housing	US6009-T
7.4L V8 454 CID	1987-1989	Base, High Sierra, Sierra Classic; High performance	US1002H	<b>YUKON XL 2500</b>			
7.4L V8 454 CID	1990-1991	Base, SLE	US1002	6.0L V8 5967cc 364 CID	2000-2006	SLE, SLT	US64
7.4L V8 454 CID	1990-1991	Base, SLE; High performance	US1002H	6.0L V8 5967cc 364 CID	2000-2006	SLE, SLT; Includes thermostat and thermostat housing	US64-T
<b>YUKON</b>				6.0L V8 5967cc 364 CID	2007-2013	SLE, SLT	US6009
4.8L V8 294 CID	2000-2005	SLE, SLT	US64	6.0L V8 5967cc 364 CID	2007-2013	SLE, SLT; Includes thermostat and thermostat housing	US6009-T
4.8L V8 294 CID	2000-2005	SLE, SLT; Includes thermostat and thermostat housing	US64-T	8.1L V8 496 CID	2001-2006	SLE, SLT	US5089
4.8L V8 294 CID	2006	SL, SLE	US64	8.1L V8 496 CID	2001-2006	SLE, SLT; High performance	US5089H
4.8L V8 294 CID	2006	SL, SLE; Includes thermostat and thermostat housing	US64-T	<b>HONDA</b>			
4.8L V8 294 CID	2007-2009	SLE	US6009	<b>ACCORD</b>			
4.8L V8 294 CID	2007-2009	SLE; Includes thermostat and thermostat housing	US6009-T	1.6L L4 1599cc	1976-1978		US9034
5.3L V8 5328cc 325 CID	2000-2005	SLE, SLT	US64	1.8L L4 1751cc	1979		US9034
5.3L V8 5328cc 325 CID	2000-2005	SLE, SLT; Includes thermostat and thermostat housing	US64-T	1.8L L4 1751cc	1980	Base, LX	US9029
5.3L V8 5328cc 325 CID	2006	SL, SLE, SLT	US64	1.8L L4 1751cc	1981	Base, LX, SE	US9029
5.3L V8 5328cc 325 CID	2006	SL, SLE, SLT; Includes thermostat and thermostat housing	US64-T	1.8L L4 1751cc	1982	Base, LX	US9035
5.3L V8 5328cc 325 CID	2007-2009	SLE, SLT	US6009	1.8L L4 1751cc	1983	Base, LX, SE	US9035
5.3L V8 5328cc 325 CID	2007-2009	SLE, SLT; Includes thermostat and thermostat housing	US6009-T	1.8L L4 1829cc	1984	Base, LX; Early	US9056
5.3L V8 5328cc 325 CID	2010	Denali, SLE, SLT	US6009	1.8L L4 1829cc	1984	Base, LX; Late	US9056
5.3L V8 5328cc 325 CID	2010	Denali, SLE, SLT; Includes thermostat and thermostat housing	US6009-T	1.8L L4 1829cc	1985	Base, LX, S, SEi	US9056
5.3L V8 5328cc 325 CID	2011-2014	SLE, SLT	US6009	2.0L L4 1955cc	1986-1988	DX, LX, LXi	US9083
5.3L V8 5328cc 325 CID	2011-2014	SLE, SLT; Includes thermostat and thermostat housing	US6009-T	2.0L L4 1955cc	1989	DX, LX, LXi, SEi	US9083
5.3L V8 5328cc 325 CID	2015-2017	SLE, SLT	US8918	2.2L L4 2156cc	1990	DX, EX, LX	US9209
5.7L V8 350 CID	1992	Base, SLE, Sport	US5049	2.2L L4 2156cc	1991	DX, EX, LX, SE	US9209
5.7L V8 350 CID	1992	Base, SLE, Sport; High performance	US5049H	2.2L L4 2156cc	1992	DX, EX, LX	US9209
5.7L V8 350 CID	1993	Base, GT, SLE	US5049	2.2L L4 2156cc	1993	10th Anniversary, DX, EX, LX, SE	US9209
5.7L V8 350 CID	1993	Base, GT, SLE; High performance	US5049H	2.2L L4 2156cc	1994-1995	DX, EX, LX	US9209
5.7L V8 350 CID	1994	Base, SLE, Sport	US5049	2.2L L4 2156cc	1996	25th Anniversary Edition, DX, EX, LX, Value Package	US9209
5.7L V8 350 CID	1994	Base, SLE, Sport; High performance	US5049H	2.2L L4 2156cc	1997	DX, EX, LX, SE, Value Package	US9209
5.7L V8 350 CID	1995	Base, SLE, SLT	US5049	2.3L L4 2254cc	1998-1999	DX, EX, LX	US9209
5.7L V8 350 CID	1995	Base, SLE, SLT; High performance	US5049H	2.3L L4 2254cc	2000	DX, EX, LX, SE	US9209
5.7L V8 350 CID	1996-1997	SL, SLE, SLT	US5077	2.3L L4 2254cc	2001	DX, EX, LX, Value Package	US9209
5.7L V8 350 CID	1996-1997	SL, SLE, SLT; High performance	US5077H	2.3L L4 2254cc	2002	DX, EX, LX, SE, Value Package	US9209
5.7L V8 350 CID	1998	SLE, SLT	US5077	2.4L L4 2354cc 144 CID	2003-2004	DX, EX, LX; Exc. Japan Built	US9461
5.7L V8 350 CID	1998-1999	SLE, SLT; High performance	US5077H	2.4L L4 2354cc 144 CID	2003-2004	DX, EX, LX; Japan Built	US9461
5.7L V8 350 CID	1999	Denali, SLE, SLT	US5077	2.4L L4 2354cc 144 CID	2005	DX, EX, LX, SE; Exc. Japan Built	US9461
5.7L V8 350 CID	2000	Denali	US5077	2.4L L4 2354cc 144 CID	2005	DX, EX, LX, SE; Japan Built	US9461
6.0L V8 5967cc 364 CID	2001-2006	Denali	US64	2.4L L4 2354cc 144 CID	2006	EX, LX, Value Package; Exc. Japan Built	US9461
6.0L V8 5967cc 364 CID	2001-2006	Denali; Includes thermostat and thermostat housing	US64-T	2.4L L4 2354cc 144 CID	2006	EX, LX, Value Package; Japan Built	US9461
6.0L V8 5967cc 364 CID	2008-2009	Hybrid	US6009	2.4L L4 2354cc 144 CID	2007	LX Special Edition	US9461
6.0L V8 5967cc 364 CID	2008-2009	Hybrid; Includes thermostat and thermostat housing	US6009-T	2.4L L4 2354cc 144 CID	2007	EX, LX, Special Edition, Value Package; Exc. Japan Built	US9461
6.0L V8 5967cc 364 CID	2010-2013	Denali Hybrid, Hybrid	US6009	2.4L L4 2354cc 144 CID	2007	EX, LX, Special Edition, Value Package; Japan Built	US9461
6.0L V8 5967cc 364 CID	2010-2013	Denali Hybrid, Hybrid; Includes thermostat and thermostat housing	US6009-T	2.4L L4 2354cc 144 CID	2008-2010	EX, EX-L, LX, LX-P, LX-S	US6233
6.2L V8 6162cc 376 CID	2007-2009	Denali	US6009	2.4L L4 2354cc 144 CID	2011-2012	EX, EX-L, LX, LX-P, LX-S, SE	US6233
6.2L V8 6162cc 376 CID	2007-2009	Denali; Includes thermostat and thermostat housing	US6009-T	2.4L L4 2354cc 144 CID	2013-2016	EX, EX-L, LX, LX-S, Sport	US8103
6.2L V8 6162cc 376 CID	2011-2014	Denali	US6009	2.4L L4 2354cc 144 CID	2017	EX, EX-L, LX, LX-S, Sport, Special Edition	US8103
6.2L V8 6162cc 376 CID	2011-2014	Denali; Includes thermostat and thermostat housing	US6009-T	2.7L V6 2675cc	1995-1997	EX, LX	US9097
6.2L V8 6162cc 376 CID	2015-2017	Denali	US8918	3.0L V6 2997cc	1998-2002	EX, LX	US9383
6.2L V8 6162cc 378 CID	2009	Mexican Application	US6009	3.0L V6 2997cc	2003-2004	EX, LX	US9470
6.5L V8 395 CID	1994	Base, SLE, Sport	US5062	3.0L V6 2997cc	2005	EX, Hybrid, LX, SE	US9470
6.5L V8 395 CID	1995	Base, SLE, SLT	US5062	3.0L V6 2997cc	2006	EX, Hybrid, LX	US9470
6.5L V8 395 CID	1996	SL, SLE, SLT; Early	US5062	3.0L V6 2997cc	2007	EX, Hybrid, LX, Special Edition	US9470
6.5L V8 395 CID	1996	SL, SLE, SLT; Late	US5074	3.5L V6 3471cc	2008-2012	EX, EX-L	US9470
6.5L V8 395 CID	1997	SL, SLE, SLT	US5074	3.5L V6 3471cc	2013-2017	EX-L, Touring	US9470
<b>YUKON XL</b>				<b>ACCORD CROSSTOUR</b>			
5.3L V8 5328cc 325 CID	2015-2017	SLE, SLT	US8918	3.5L V6 3471cc	2010-2011	EX, EX-L	US9470
6.2L V8 6162cc 376 CID	2015-2017	Denali	US8918	<b>CITY</b>			
<b>YUKON XL 1500</b>				1.5L L4 1496cc 91 CID	2010-2014	Mexican Application	US6350
5.3L V8 5328cc 325 CID	2000-2005	SLE, SLT	US64	<b>CIVIC</b>			
5.3L V8 5328cc 325 CID	2000-2005	SLE, SLT; Includes thermostat and thermostat housing	US64-T	1.2L L4 1237cc	1975-1977		US9033
5.3L V8 5328cc 325 CID	2006	SL, SLE, SLT	US64	1.3L L4 1335cc	1980-1981	1300, 1300 DX	US9043N
5.3L V8 5328cc 325 CID	2006	SL, SLE, SLT; Includes thermostat and thermostat housing	US64-T	1.3L L4 1335cc	1982-1983	1300, 1300 FE	US9043N
5.3L V8 5328cc 325 CID	2007-2014	SLE, SLT	US6009	1.3L L4 1339cc	2003-2008	Hybrid	US6216
5.3L V8 5328cc 325 CID	2007-2014	SLE, SLT; Includes thermostat and thermostat housing	US6009-T	1.3L L4 1339cc	2009-2011	Hybrid, Hybrid-L	US6216
6.0L V8 5967cc 364 CID	2001-2006	Denali	US64	1.3L L4 1342cc 82 CID	1984	CRX	US9069
				1.3L L4 1342cc 82 CID	1985-1987	Base	US9069
				1.5L L4 1487cc	1975-1979		US9034
				1.5L L4 1487cc	1980	1500, 1500 DX, 1500 GL	US9035
				1.5L L4 1487cc	1981	1500 DX, 1500 GL, Base	US9035



Engine	Years	Application Description	USMW	Engine	Years	Application Description	USMW
<b>HONDA (cont'd.)</b>				<b>HONDA (cont'd.)</b>			
<b>CIVIC (cont'd.)</b>				<b>FIT</b>			
1.5L L4 1487cc	1982	1500 DX, 1500 GL, Base, Wagovan	US9035	1.5L H4 1496cc 91 CID	2006	Mexican Application	US6018
1.5L L4 1487cc	1983	1500 DX, 1500 S, Base, Wagovan	US9035	1.5L H4 1496cc 91 CID	2011-2014	Mexican Application	US6350
1.5L L4 1487cc	1984	1500 S, Base, CRX 1.5, DX	US9069	1.5L L4 1496cc 91 CID	2010-2014	Mexican Application	US6350
1.5L L4 1487cc	1985	1500 S, Base, CRX Si, DX	US9069	1.5L L4 1497cc	2007-2008	Base, Sport	US6018
1.5L L4 1487cc	1986	CRX, CRX HF, CRX Si, DX, Si	US9069	1.5L L4 1497cc	2009-2013	Base, Sport	US6350
1.5L L4 1487cc	1987	Base, CRX, CRX HF, CRX Si, DX, Si	US9069	1.5L L4 1497cc	2015-2017	EX, EX-L, LX	US8119
1.5L L4 1493cc	1986	Base	US9069	<b>INSIGHT</b>			
1.5L L4 1493cc	1988-1989	Base, DX, LX, Wagovan	US9130	1.0L L3 995cc 61 CID	2000-2006	Base	US9494
1.5L L4 1493cc	1990-1991	Base, DX, LX	US9130	1.3L L4 1339cc	2010	EX, LX	US8983
1.5L L4 1493cc	1992-1995	CX, DX, LX	US9130	1.3L L4 1339cc	2011-2014	Base, EX, LX	US8983
1.5L L4 1493cc	1992-1995	VX	US9250	<b>ODYSSEY</b>			
1.5L L4 1497cc	2012-2015	Hybrid, Hybrid-L	US8144	2.2L L4 2156cc	1995-1997	EX, LX	US9209
1.5L L4 1497cc	2016	EX-L, EX-T, Touring	US8145	2.3L L4 2234cc	1998	EX, LX	US9209
1.5L L4 1497cc	2017	EX, EX-L, EX-T, LX, Si, Sport, Touring	US8145	3.5L V6 3471cc	2005-2010	EX, EX-L, LX, Touring	US9470
1.6L L4 1590cc	1996-2000	HX	US9352	3.5L V6 3471cc	2011-2015	EX, EX-L, LX, Touring, Touring Elite	US9470
1.6L L4 1590cc 97 CID	1988	RT 4WD	US9130	3.5L V6 3471cc	2016-2017	EX, EX-L, LX, SE, Touring, Touring Elite	US9470
1.6L L4 1590cc 97 CID	1989	RT 4WD, Si	US9130	3.5L V6 3474cc	1999-2001	Cargo, EX, LX	US9383
1.6L L4 1590cc 97 CID	1990-1991	EX, RT 4WD, Si	US9130	3.5L V6 3474cc	2002	Cargo, EX, EX-L, LX	US9383
1.6L L4 1590cc 97 CID	1992-1995	EX, Si	US9250	3.5L V6 3474cc	2003	EX, EX-L, LX	US9383
1.6L L4 1590cc 97 CID	1996-1997	CX, DX, EX, LX	US9352	3.5L V6 3474cc	2004	EX, LX	US9383
1.6L L4 1590cc 97 CID	1998	CX, DX, EX, GX, LX	US9352	<b>PASSPORT</b>			
1.6L L4 1590cc 97 CID	1999	CX, DX, EX, GX, LX, Value Package	US9352	2.6L L4 2559cc	1994-1996	DX	US9133
1.6L L4 1590cc 97 CID	1999-2000	Mexican Application	US9468	3.2L V6 3165cc	1994-1997	EX, LX	US9278
1.6L L4 1590cc 97 CID	2000	CX, DX, EX, GX, LX	US9352	3.2L V6 3165cc	1998-2002	EX, LX	US9365
1.6L L4 1595cc	1999-2000	Si	US9468	<b>PILOT</b>			
1.7L L4 1668cc	2001	DX, EX, GX, HX, LX	US9419	3.5L V6 3471cc	2005	EX, LX; Canada Built	US9470
1.7L L4 1668cc	2005	DX, EX, EX Special Edition, GX, HX, LX, LX Special Edition, Value Package	US9419	3.5L V6 3471cc	2005	EX, LX; USA Built	US9470
1.7L L4 1700cc	2002-2003	DX, EX, GX, HX, LX	US9419	3.5L V6 3471cc	2006-2007	EX, LX	US9470
1.7L L4 1700cc	2004	DX, EX, GX, HX, LX, Value Package	US9419	3.5L V6 3471cc	2008	EX, EX-L, Special Edition, Value Package	US9470
1.8L L4 1799cc	2006-2008	DX, EX, GX, LX	US6056	3.5L V6 3471cc	2009-2014	EX, EX-L, LX, Touring	US9470
1.8L L4 1799cc	2009-2011	DX, EX, EX-L, GX, LX, LX-S	US6056	3.5L V6 3471cc	2015	EX, EX-L, LX, SE, Touring	US9470
1.8L L4 1799cc	2012	DX, EX, EX-L, GX, HF, LX	US6693	3.5L V6 3471cc	2016-2017	Elite, EX, EX-L, LX, Touring	US9470
1.8L L4 1799cc	2013-2014	EX, EX-L, HF, LX, Natural Gas	US6693	3.5L V6 3475cc	2003-2004	EX, LX	US9383
1.8L L4 1799cc	2015	EX, EX-L, HF, LX, Natural Gas, SE	US6693	<b>PRELUDE</b>			
1.8L L4 1799cc 110 CID	2014-2015	EX, EX-L, LX	US6693	1.8L L4 1751cc	1979		US9034
2.0L L4 1996cc 122 CID	2016-2017	EX, LX, LX-P	US8103	1.8L L4 1751cc	1980-1981	Base	US9029
2.0L L4 1998cc 122 CID	2002-2005	Si	US9434	1.8L L4 1751cc	1982	Base	US9035
2.0L L4 1998cc 122 CID	2006-2007	Si	US9495	1.8L L4 1829cc	1983-1987	Base	US9056
2.0L L4 1998cc 122 CID	2008	MUGEN Si, Si	US9495	2.0L L4 1955cc	1985-1987	2.0 Si	US9083
2.0L L4 1998cc 122 CID	2009-2011	Si	US9495	2.0L L4 1958cc	1988-1989	2.0 Si, 2.0 Si 4WS	US9129
2.4L L4 2354cc 144 CID	2012-2015	Si	US6213	2.0L L4 1958cc	1988-1990	2.0 S	US9131
<b>CIVIC DEL SOL</b>				2.0L L4 1958cc	1990-1991	2.0 Si	US9129
1.5L L4 1493cc	1993-1995	S	US9130	2.1L L4 2056cc	1990-1991	Si, Si 4WS, Si ALB	US9129
1.6L L4 1590cc 97 CID	1993-1995	Si	US9130	2.2L L4 2156cc	1992-1996	S	US9209
1.6L L4 1590cc 97 CID	1994-1995	VTEC	US9321	2.2L L4 2156cc	1993-1996	VTEC	US9273
1.6L L4 1590cc 97 CID	1996-1997	S, Si	US9352	2.2L L4 2156cc	1997-2001	Base, Type SH	US9273
1.6L L4 1595cc	1996-1997	VTEC	US9468	2.3L L4 2259cc	1992-1994	Si, Si 4WS	US9251
<b>CROSSTOUR</b>				2.3L L4 2259cc	1995	SE, Si	US9251
2.4L L4 2354cc 144 CID	2015	EX, EX-L	US8138	2.3L L4 2259cc	1996	Si	US9251
3.5L V6 3471cc	2012-2015	EX, EX-L	US9470	<b>RIDGELINE</b>			
<b>CR-V</b>				3.5L V6 3471cc	2006	RT, RTL, RTS	US9470
1.5L L4 1497cc	2017	EX, EX-L, Touring	US8145	3.5L V6 3471cc	2007-2008	RT, RTL, RTS, RTX	US9470
2.0L L4 1972cc	1997	LX	US9349	3.5L V6 3471cc	2009-2011	RT, RTL, RTS	US9470
2.0L L4 1972cc	1998-1999	EX, LX	US9349	3.5L V6 3471cc	2012-2013	RT, RTL, RTS, Sport	US9470
2.0L L4 1972cc	2000-2001	EX, LX, SE	US9349	3.5L V6 3471cc	2014	RT, RTL, RTS, SE, Sport	US9470
2.4L L4 2354cc 144 CID	2002-2004	EX, LX; Exc.Japan Built	US9434	3.5L V6 3471cc	2017	Black Edition, RT, RTL, RTL-E, RTL-T, RTS, Sport	US9470
2.4L L4 2354cc 144 CID	2002-2004	EX, LX; Japan Built	US9434	<b>S2000</b>			
2.4L L4 2354cc 144 CID	2005-2006	EX, LX, SE; Exc.Japan Built	US9434	2.0L L4 1997cc	2000-2003	Base	US9403
2.4L L4 2354cc 144 CID	2005-2006	EX, LX, SE; Japan Built	US9434	2.2L L4 2157cc	2004-2007	Base	US9403
2.4L L4 2354cc 144 CID	2007-2009	EX, EX-L, LX; Exc.Japan Built	US9461	2.2L L4 2157cc	2008-2009	Base, CR	US9403
2.4L L4 2354cc 144 CID	2007-2009	EX, EX-L, LX; Japan Built	US9461	<b>WAGOVAN</b>			
2.4L L4 2354cc 144 CID	2010	EX, EX-L, LX	US6233	1.5L L4 1487cc	1984	DX	US9069
2.4L L4 2354cc 144 CID	2011	EX, EX-L, LX, SE	US6233	1.5L L4 1487cc	1986-1987	DX	US9069
2.4L L4 2354cc 144 CID	2012-2014	EX, EX-L, LX	US8137	<b>HUMMER</b>			
2.4L L4 2354cc 144 CID	2015	EX, EX-L, LX, Touring	US8118	<b>H1</b>			
2.4L L4 2354cc 144 CID	2016	EX, EX-L, LX, SE, Touring	US8118	6.5L V8 395 CID	2002-2004	Base	US5086
2.4L L4 2354cc 144 CID	2017	LX	US8118	<b>H2</b>			
<b>CRX</b>				6.0L V8 5967cc 364 CID	2003-2006	Base	US64
1.5L L4 1493cc	1988	DX, HF	US9130	6.0L V8 5967cc 364 CID	2003-2006	Base; Includes thermostat and thermostat housing	US64-T
1.5L L4 1493cc	1989-1991	Base, HF	US9130	6.0L V8 5967cc 364 CID	2007	Base	US6009
1.6L L4 1590cc 97 CID	1988-1991	Si	US9130	6.0L V8 5967cc 364 CID	2007	Base; Includes thermostat and thermostat housing	US6009-T
<b>CR-Z</b>				6.2L V8 6162cc 376 CID	2008-2009	Base	US6009
1.5L L4 1497cc 91 CID	2011-2015	Base, EX	US8983	6.2L V8 6162cc 376 CID	2008-2009	Base; Includes thermostat and thermostat housing	US6009-T
1.5L L4 1497cc 91 CID	2016	EX, EX-L, LX	US8983	<b>ELEMENT</b>			
<b>ELEMENT</b>				2.4L L4 2354cc 144 CID	2003	DX, EX	US9461
2.4L L4 2354cc 144 CID	2004	DX, EX, LX	US9461	2.4L L4 2354cc 144 CID	2005-2006	EX, LX	US9461
2.4L L4 2354cc 144 CID	2007-2010	EX, LX, SC	US9461	2.4L L4 2354cc 144 CID	2011	EX, LX	US9461
2.4L L4 2354cc 144 CID	2011	EX, LX	US9461				

WATER PUMPS



# WATER PUMP APPLICATION GUIDE



Engine	Years	Application Description	USMW
<b>HUMMER (cont'd.)</b>			
<b>H3</b>			
3.5L L4 3460cc 211 CID	2006	Base	<b>US5097</b>
3.7L L5 3654cc 223 CID	2007-2009	Base, X	<b>US5097</b>
3.7L L5 3654cc 223 CID	2010	Base	<b>US5097</b>
5.3L V8 5328cc 325 CID	2008	Alpha	<b>US6009</b>
5.3L V8 5328cc 325 CID	2008	Alpha; Includes thermostat and thermostat housing	<b>US6009-T</b>
5.3L V8 5328cc 325 CID	2009	Alpha, Championship Series	<b>US6009</b>
5.3L V8 5328cc 325 CID	2009	Alpha, Championship Series; Includes thermostat and thermostat housing	<b>US6009-T</b>
5.3L V8 5328cc 325 CID	2010	Alpha	<b>US6009</b>
5.3L V8 5328cc 325 CID	2010	Alpha; Includes thermostat and thermostat housing	<b>US6009-T</b>
<b>H3T</b>			
3.7L L5 3654cc 223 CID	2009-2010	Base	<b>US5097</b>
5.3L V8 5328cc 325 CID	2009-2010	Alpha	<b>US6009</b>
5.3L V8 5328cc 325 CID	2009-2010	Alpha; Includes thermostat and thermostat housing	<b>US6009-T</b>
<b>HYUNDAI</b>			
<b>ACCENT</b>			
1.5L L4 1495cc	1995-1996	Base, L	<b>US7115</b>
1.5L L4 1495cc	1996-1997	GT	<b>US9364</b>
1.5L L4 1495cc	1997	GL, GS, L	<b>US7115</b>
1.5L L4 1495cc	1998	GL, GS, GSi, L	<b>US7115</b>
1.5L L4 1495cc	1999-2000	GL, GS, L	<b>US7115</b>
1.5L L4 1495cc	2001	L; To 04/07/2001	<b>US7115</b>
1.5L L4 1495cc	2001	L; From 04/07/2001	<b>US9364</b>
1.5L L4 1495cc	2002	L	<b>US9364</b>
1.6L L4 1591cc 97 CID	2012-2014	GLS, GS, SE	<b>US6247</b>
1.6L L4 1591cc 97 CID	2015	GLS, GS, Sport	<b>US6247</b>
1.6L L4 1591cc 97 CID	2016	SE, Sport	<b>US6247</b>
1.6L L4 1591cc 97 CID	2017	SE, Sport, Value Edition	<b>US6247</b>
1.6L L4 1599cc	2006	GLS	<b>US9364</b>
1.6L L4 1599cc	2007-2009	GLS, GS, SE	<b>US9364</b>
1.6L L4 1599cc	2010	Blue, GLS, GS, SE	<b>US9364</b>
1.6L L4 1599cc	2011	GL, GLS, GS, SE	<b>US9364</b>
1.6L L4 1600cc	2001	GL, GS	<b>US9364</b>
1.6L L4 1600cc	2002	GL, GS; From 04/12/2002	<b>US9364</b>
1.6L L4 1600cc	2002	GL, GS; To 04/12/2002	<b>US9364</b>
1.6L L4 1600cc	2003	Base, GL	<b>US9364</b>
1.6L L4 1600cc	2004	Base, GL, GT	<b>US9364</b>
1.6L L4 1600cc	2005	GLS, GT	<b>US9364</b>
<b>AZERA</b>			
3.3L V6 3342cc	2007-2009	GLS	<b>US6048</b>
3.3L V6 3342cc	2010	GLS; From 11/03/2009	<b>US6048</b>
3.3L V6 3342cc	2010	GLS; To 11/03/2009	<b>US6048</b>
3.3L V6 3342cc	2011	GLS	<b>US6048</b>
3.3L V6 3342cc	2012	Base	<b>US6048</b>
3.3L V6 3342cc	2013-2014	Base; From 04/11/2013	<b>US6048</b>
3.3L V6 3342cc	2013-2014	Base; To 04/11/2013	<b>US6048</b>
3.3L V6 3342cc	2014-2017	Base, Limited	<b>US6048</b>
3.8L V6 3778cc	2006	Limited, SE; From 05/22/2006	<b>US6048</b>
3.8L V6 3778cc	2006	Limited, SE; To 05/22/2006	<b>US6048</b>
3.8L V6 3778cc	2007	Limited, SE	<b>US6048</b>
3.8L V6 3778cc	2008-2009	Limited	<b>US6048</b>
3.8L V6 3778cc	2010	Limited; From 11/03/2009	<b>US6048</b>
3.8L V6 3778cc	2010	Limited; To 11/03/2009	<b>US6048</b>
3.8L V6 3778cc	2011	Limited	<b>US6048</b>
<b>ELANTRA</b>			
1.6L L4 1591cc 97 CID	2017	Sport	<b>US6247</b>
1.6L L4 1596cc	1992	Base, GL, GLS	<b>US7131</b>
1.6L L4 1596cc	1993-1995	Base	<b>US7131</b>
1.8L L4 1795cc	1996-1997	Base, GL, GLS	<b>US9353</b>
1.8L L4 1796cc	1998	Base, GL, GLS	<b>US9353</b>
1.8L L4 1797cc	2011-2013	GLS, Limited	<b>US8106</b>
1.8L L4 1797cc	2014-2015	Limited, SE	<b>US8106</b>
1.8L L4 1797cc	2016	Limited, SE, Value Edition	<b>US8106</b>
1.8L L4 1797cc 110 CID	2015	Limited	<b>US8106</b>
1.8L L4 1836cc	1993-1995	Base, GLS	<b>US9212</b>
2.0L L4 1975cc	1999	GL, GLS; From 03/10/1999, To 06/03/1999	<b>US9353</b>
2.0L L4 1975cc	1999	GL, GLS; From 06/03/1999	<b>US9353</b>
2.0L L4 1975cc	1999	GL, GLS; To 03/10/1999	<b>US9353</b>
2.0L L4 1975cc	2000	GLS	<b>US9353</b>
2.0L L4 1975cc	2001-2005	GLS, GT	<b>US8972</b>
2.0L L4 1975cc	2006	GLS, GT, Limited	<b>US8972</b>
2.0L L4 1975cc	2007	GLS, Limited, SE	<b>US8972</b>
2.0L L4 1975cc	2008	GLS, SE	<b>US8972</b>
2.0L L4 1975cc	2009	GLS, SE, Touring	<b>US8972</b>
2.0L L4 1975cc	2010	Blue, GLS, SE, Touring GLS, Touring SE	<b>US8972</b>
2.0L L4 1975cc	2011-2012	Touring GLS, Touring SE	<b>US8972</b>
2.0L L4 1999cc	2014-2016	Sport	<b>US8106</b>
2.0L L4 1999cc	2017	Limited, SE, Value Edition	<b>US8106</b>

Engine	Years	Application Description	USMW
<b>HYUNDAI (cont'd.)</b>			
<b>ELANTRA COUPE</b>			
1.8L L4 1797cc	2013	GS, SE	<b>US8106</b>
2.0L L4 1999cc	2014	GS	<b>US8106</b>
<b>ELANTRA GT</b>			
1.8L L4 1797cc	2013	Base	<b>US8106</b>
2.0L L4 1999cc	2014-2017	Base	<b>US8106</b>
<b>ENTOURAGE</b>			
3.8L V6 3778cc	2007	GLS, Limited, SE; From 05/22/2006	<b>US6048</b>
3.8L V6 3778cc	2007	GLS, Limited, SE; To 05/22/2006	<b>US6048</b>
3.8L V6 3778cc	2008	GLS, Limited	<b>US6048</b>
<b>EXCEL</b>			
1.5L L4 1468cc	1986-1990	Base, GL, GLS	<b>US7115</b>
1.5L L4 1468cc	1991	Base, GL, GLS, GS	<b>US7115</b>
1.5L L4 1468cc	1992-1994	Base, GL, GS	<b>US7115</b>
<b>GENESIS</b>			
3.8L V6 3778cc	2009-2012	3.8	<b>US6048</b>
3.8L V6 3778cc	2013	3.8; From 04/11/2013	<b>US6048</b>
3.8L V6 3778cc	2013	3.8; To 04/11/2013	<b>US6048</b>
3.8L V6 3778cc	2014	3.8	<b>US6048</b>
<b>GENESIS COUPE</b>			
3.8L V6 3778cc	2010	3.8, 3.8 Grand Touring, 3.8 Track	<b>US6048</b>
3.8L V6 3778cc	2011	3.8, 3.8 Grand Touring, 3.8 R-Spec, 3.8 Track	<b>US6048</b>
3.8L V6 3778cc	2012	3.8 Grand Touring, 3.8 R-Spec, 3.8 Track	<b>US6048</b>
3.8L V6 3778cc	2013	3.8 Grand Touring, 3.8 R-Spec, 3.8 Track; From 04/13/2013	<b>US6048</b>
3.8L V6 3778cc	2013	3.8 Grand Touring, 3.8 R-Spec, 3.8 Track; To 04/13/2013	<b>US6048</b>
3.8L V6 3778cc	2014	3.8 Grand Touring, 3.8 R-Spec, 3.8 Ultimate	<b>US6048</b>
3.8L V6 3778cc	2015-2016	3.8, 3.8 R-Spec, 3.8 Ultimate	<b>US6048</b>
<b>SANTA FE</b>			
2.4L L4 2351cc	2001	GL	<b>US9399</b>
2.4L L4 2351cc	2002-2004	Base	<b>US9399</b>
2.4L L4 2359cc	2010-2012	GLS, Limited	<b>US6220</b>
2.7L V6 2656cc	2001	GL, GLS, LX	<b>US9462</b>
2.7L V6 2656cc	2002	GLS, LX	<b>US9462</b>
2.7L V6 2656cc	2003-2004	GLS	<b>US9462</b>
2.7L V6 2656cc	2005	Base, GLS	<b>US9462</b>
2.7L V6 2656cc	2006	GLS	<b>US9462</b>
2.7L V6 2656cc	2007-2009	GLS	<b>US6215</b>
3.3L V6 3342cc	2007	Limited, SE; From 01/29/2007	<b>US6048</b>
3.3L V6 3342cc	2007	Limited, SE; To 01/29/2007	<b>US6048</b>
3.3L V6 3342cc	2008-2009	Limited, SE	<b>US6048</b>
3.3L V6 3342cc	2013	GLS, Limited; From 04/11/2013	<b>US6048</b>
3.3L V6 3342cc	2013	GLS, Limited; To 04/11/2013	<b>US6048</b>
3.3L V6 3342cc	2014-2015	GLS, Limited	<b>US6048</b>
3.3L V6 3342cc	2016	Limited, SE	<b>US6048</b>
3.3L V6 3342cc	2017	Limited, Limited Ultimate, SE, SE Ultimate	<b>US6048</b>
3.5L V6 3467cc	2006	GLS, Limited	<b>US9463</b>
3.5L V6 3470cc	2010	Limited, SE	<b>US6048</b>
3.5L V6 3470cc	2011-2012	GLS, Limited, SE	<b>US6048</b>
3.5L V6 3500cc	2003-2005	GLS, LX	<b>US9463</b>
<b>SANTA FE SPORT</b>			
2.0L L4 1998cc 122 CID	2014-2016	2.0T	<b>US6220</b>
2.0L L4 1998cc 122 CID	2017	2.0T, 2.0T Ultimate	<b>US8163</b>
2.0L L4 1998cc 122 CID	2017	2.0T, 2.0T Ultimate; Pump only	<b>US8163</b>
2.4L L4 2359cc	2014-2016	Base	<b>US8982</b>
2.4L L4 2359cc	2017	Base	<b>US8163</b>
2.4L L4 2359cc	2017	Base; Pump only	<b>US8163</b>
<b>SCOUPE</b>			
1.5L L4 1468cc	1991-1992	Base, LS	<b>US7115</b>
1.5L L4 1495cc	1993-1995	Base, LS, Turbo	<b>US7115</b>
<b>SONATA</b>			
1.6L L4 1591cc 97 CID	2015-2017	Eco	<b>US6247</b>
2.0L L4 1997cc	1992-1993	Base, GLS	<b>US9212</b>
2.0L L4 1997cc	1994	Base, GL, GLS	<b>US9212</b>
2.0L L4 1997cc	1995-1998	Base, GL	<b>US9212</b>
2.0L L4 1998cc 122 CID	2011-2014	Limited, SE	<b>US6220</b>
2.0L L4 1998cc 122 CID	2015-2017	Limited 2.0T, Sport 2.0T	<b>US8163</b>
2.0L L4 1998cc 122 CID	2015-2017	Limited 2.0T, Sport 2.0T; Pump only	<b>US8163</b>
2.4L L4 2351cc	1989-1991	Base, GLS	<b>US7118</b>
2.4L L4 2351cc	1999-2004	Base	<b>US9399</b>
2.4L L4 2351cc	2005	GL	<b>US9399</b>
2.4L L4 2359cc	2006	GL, GLS	<b>US6220</b>
2.4L L4 2359cc	2007	GLS	<b>US6220</b>
2.4L L4 2359cc	2008-2010	GLS, Limited, SE	<b>US6220</b>
2.4L L4 2359cc	2011-2014	GLS, Limited, SE	<b>US8982</b>
2.4L L4 2359cc	2015-2017	Limited, SE, Sport	<b>US8163</b>
2.4L L4 2359cc	2015-2017	Limited, SE, Sport; Pump only	<b>US8163</b>
2.4L L4 2359cc 144 CID	2015-2016	Limited	<b>US8163</b>

Engine	Years	Application Description	USMW	Engine	Years	Application Description	USMW
<b>HYUNDAI (cont'd.)</b>				<b>INFINITI (cont'd.)</b>			
<b>SONATA (cont'd.)</b>				<b>FX45</b>			
2.5L V6 2493cc	1999-2001	GLS	US9462	4.5L V8 4494cc	2006-2008	Base	US6227
2.7L V6 2656cc	2002-2004	GLS, LX	US9462	4.5L V8 4500cc	2003-2005	Base	US6227
2.7L V6 2656cc	2005	GL, GLS, LX	US9462	<b>FX50</b>			
3.0L V6 2972cc	1990-1993	Base, GLS	US7121	5.0L V8 5026cc	2009-2013	Base	US9488
3.0L V6 2972cc	1990-1993	Base, GLS; With back plate housing	US7121-2	<b>G20</b>			
3.0L V6 2972cc	1994	Base, GL, GLS	US7121	2.0L L4 1998cc	1991-1993	Base	US9213
3.0L V6 2972cc	1994	Base, GL, GLS; With back plate housing	US7121-2	2.0L L4 1998cc	1994-1996	Base, T	US9213
3.0L V6 2972cc	1995-1998	GL, GLS	US7121	2.0L L4 2000cc	1999-2002	Base, T	US9213
3.0L V6 2972cc	1995-1998	GL, GLS; With back plate housing	US7121-2	<b>G25</b>			
3.3L V6 3342cc	2006	GLS, LX	US6048	2.5L V6 2496cc 152 CID	2011-2012	Base, Journey, X	US6198
3.3L V6 3342cc	2007	Limited, SE; From 05/22/2006	US6048	<b>G35</b>			
3.3L V6 3342cc	2007	Limited, SE; To 05/22/2006	US6048	3.5L V6 3498cc	2003	Base	US9426
3.3L V6 3342cc	2008-2009	GLS, Limited, SE	US6048	3.5L V6 3498cc	2004-2006	Base, X	US9426
3.3L V6 3342cc	2010	Limited, SE	US6048	3.5L V6 3498cc	2007	Base; (VQ35DE); From 03/07	US6198
<b>TIBURON</b>				3.5L V6 3498cc	2007	Base; (VQ35HR)	US8164
1.8L L4 1795cc	1997	Base	US9353	3.5L V6 3498cc	2007	Journey, Sport, X	US8164
2.0L L4 1975cc	1997	FX	US9353	3.5L V6 3498cc	2007	Base; (VQ35DE); To 03/2007	US9426
2.0L L4 1975cc	2003-2004	Base	US8972	3.5L V6 3498cc	2008	Base, Journey, Sport, X	US8164
2.0L L4 1975cc	2005-2008	GS	US8972	<b>G37</b>			
2.0L L4 1997cc	1998	Base, FX	US9353	3.7L V6 3696cc	2008	Base, Journey, Sport	US8164
2.0L L4 1997cc	1999	Base, FX; From 03/10/1999	US8972	3.7L V6 3696cc	2009-2010	Base, Journey, Sport, X	US8164
2.0L L4 1997cc	1999	Base, FX; To 03/10/1999	US9353	3.7L V6 3696cc	2011-2013	Base, IPL, Journey, Sport, X	US8164
2.0L L4 1997cc	2000-2001	Base	US8972	3.7L V6 3696cc 226 CID	2012	Base	US8164
2.7L V6 2656cc	2003-2004	GT	US9462	3.7L V6 3696cc 226 CID	2013	Base, Journey	US8164
2.7L V6 2656cc	2005-2006	GT, SE	US9462	<b>I30</b>			
2.7L V6 2656cc	2007-2008	GT, GT Limited, SE	US9462	3.0L V6 2988cc 182 CID	1996-2001	Base, T	US9309
<b>TUCSON</b>				<b>I35</b>			
1.6L L4 1591cc 97 CID	2016	Eco, Limited, Sport	US6247	3.5L V6 3498cc	2002-2004	Base	US9426
1.6L L4 1591cc 97 CID	2017	Eco, Limited, Sport, Value	US6247	<b>J30</b>			
2.0L L4 1975cc	2005-2006	GL	US8972	3.0L V6 2960cc 181 CID	1993-1997	Base, T	US9268
2.0L L4 1975cc	2007	GLS	US8972	<b>JX35</b>			
2.0L L4 1975cc	2008-2009	GLS, Limited	US8972	3.5L V6 3498cc	2013	Base	US6198
2.0L L4 1975cc	2011	GL	US6220	<b>M30</b>			
2.0L L4 1975cc	2012-2013	GL	US8982	3.0L V6 2960cc 181 CID	1990-1992	Base	US9058
2.0L L4 1999cc	2014-2015	GLS	US8106	<b>M35</b>			
2.0L L4 1999cc	2016	SE; From 08/28/2015	US8106	3.5L V6 3498cc	2006	Base, Sport, X	US9426
2.0L L4 1999cc	2016	SE; To 08/28/2015	US8106	3.5L V6 3498cc	2007	Base, Sport, X; From 03/07	US6198
2.0L L4 1999cc	2016-2017	SE	US8106	3.5L V6 3498cc	2007	Base, Sport, X; To 03/2007	US9426
2.4L L4 2359cc	2010-2011	GLS, Limited	US6220	3.5L V6 3498cc	2008	Base, X	US6198
2.4L L4 2359cc	2012-2013	GLS, Limited	US8982	3.5L V6 3498cc	2009-2010	Base, X	US8164
2.4L L4 2359cc	2014	Limited, SE; To 02/01/2014	US6220	<b>M35H</b>			
2.4L L4 2359cc	2014	Limited, SE; From 02/01/2014	US8982	3.5L V6 3498cc	2012-2013	Base	US8164
2.4L L4 2359cc	2014-2015	Limited, SE	US8982	<b>M37</b>			
2.7L V6 2656cc	2005	GLS, LX	US9462	3.7L V6 3696cc	2011-2013	Base, X	US8164
2.7L V6 2656cc	2006	GLS, Limited	US9462	3.7L V6 3696cc 226 CID	2012-2013	Base	US8164
2.7L V6 2656cc	2007-2009	Limited, SE	US9462	<b>M45</b>			
<b>VELOSTER</b>				4.5L V8 4494cc	2006-2007	Base, Sport	US6227
1.6L L4 1591cc 97 CID	2012	Base	US6247	4.5L V8 4494cc	2008-2010	Base, X	US6227
1.6L L4 1591cc 97 CID	2013	Base, Turbo	US6247	4.5L V8 4500cc	2003-2004		US6287
1.6L L4 1591cc 97 CID	2014-2015	Base, RE:FLEX, Turbo, Turbo R-Spec	US6247	<b>M56</b>			
1.6L L4 1591cc 97 CID	2016	Base, Rally Edition, Turbo, Turbo R-Spec	US6247	5.6L V8 5552cc	2011-2013	Base, X	US9488
1.6L L4 1591cc 97 CID	2017	Base, Turbo, Turbo R-Spec	US6247	<b>Q40</b>			
<b>VERACRUZ</b>				3.7L V6 3696cc	2015	Base	US8164
3.8L V6 3778cc	2007-2008	GLS, Limited, SE	US6048	<b>Q45</b>			
3.8L V6 3778cc	2009	GLS, Limited	US6048	4.1L V8 4130cc	1997-1999	Base, T	US9388
3.8L V6 3778cc	2010	GLS, Limited; From 11/03/2009	US6048	4.1L V8 4130cc	2000	Anniversary Edition, Base, T	US9388
3.8L V6 3778cc	2010	GLS, Limited; To 11/03/2009	US6048	4.1L V8 4130cc	2001	Base, T	US9388
3.8L V6 3778cc	2011-2012	GLS, Limited	US6048	4.5L V8 4494cc	1990	Base	US9239
<b>XG300</b>				4.5L V8 4494cc	1991-1992	A, Base	US9239
3.0L V6 2972cc	2001	Base, L	US9463	4.5L V8 4494cc	1993	A, Base; To 02/1993	US9239
<b>XG350</b>				4.5L V8 4494cc	1993	A, Base; From 02/1993	US9304
3.5L V6 3500cc	2002-2005	Base, L	US9463	4.5L V8 4494cc	1994-1996	A, Base, T	US9304
<b>INFINITI</b>				4.5L V8 4494cc	2002-2004		US6287
<b>EX35</b>				4.5L V8 4494cc	2005-2006	Base	US6227
3.5L V6 3498cc	2008-2012	Base, Journey	US8164	<b>Q50</b>			
<b>EX37</b>				3.5L V6 3498cc	2014-2015	Hybrid Premium, Hybrid Sport	US8164
3.7L V6 3696cc	2013	Base, Journey	US8164	3.5L V6 3498cc	2016-2017	Hybrid Premium	US8164
<b>FX35</b>				3.7L V6 3696cc	2014-2015	Base, Premium, Sport	US8164
3.5L V6 3498cc	2003-2006	Base	US9426	<b>Q60</b>			
3.5L V6 3498cc	2007	Base; From 03/07	US6198	3.7L V6 3696cc	2014	Base, IPL, Journey, S	US8164
3.5L V6 3498cc	2007	Base; To 03/2007	US9426	3.7L V6 3696cc	2015	Base, IPL, Journey, S, S Limited	US8164
3.5L V6 3498cc	2008	Base	US6198	<b>Q70</b>			
3.5L V6 3498cc	2009-2012	Base	US8164	3.5L V6 3498cc	2014-2017	Hybrid	US8164
<b>FX37</b>				3.7L V6 3696cc	2014-2017	3.7	US8164
3.7L V6 3696cc	2013	Base	US8164				
3.7L V6 3696cc 226 CID	2013	Base	US8164				

WATER PUMPS





# WATER PUMP APPLICATION GUIDE



Engine	Years	Application Description	USMW	Engine	Years	Application Description	USMW
<b>INFINITI (cont'd.)</b>				<b>INTERNATIONAL (cont'd.)</b>			
<b>Q70 (cont'd.)</b>				<b>1000D (cont'd.)</b>			
5.6L V8 5552cc	2014-2017	5.6	US9488	5.6L V8 5654cc 345 CID	1969-1970		US1099
<b>Q70L</b>				6.4L V8 6424cc 392 CID	1969-1970		US1099
3.7L V6 3696cc	2015-2017	3.7	US8164	<b>1010</b>			
5.6L V8 5552cc	2015-2017	5.6	US9488	5.0L V8 304 CID	1972-1973		US1099
<b>QX4</b>				5.0L V8 4982cc 304 CID	1971-1973		US1099
3.3L V6 3275cc	1997-2000	Base	US9338	5.0L V8 4983cc 304 CID	1972-1973		US1099
3.5L V6 3498cc	2001-2003	Base	US9309	5.6L V8 5654cc 345 CID	1971-1973		US1099
<b>QX50</b>				5.7L V8 345 CID	1971-1973		US1099
3.7L V6 3696cc	2014-2015	Base, Journey	US8164	6.4L V8 392 CID	1972-1973		US1099
3.7L V6 3696cc	2016-2017	Base	US8164	6.4L V8 6424cc 392 CID	1971-1973		US1099
<b>QX56</b>				6.4L V8 6425cc 392 CID	1972-1973		US1099
5.6L V8 5552cc	2004-2013	Base	US9488	<b>1100A</b>			
<b>QX60</b>				4.3L L6 4335cc 264 CID	1966		US1099
2.5L L4 2488cc 152 CID	2014-2017	Hybrid	US8105	4.3L V8 4360cc 266 CID	1966		US1099
3.5L V6 3498cc	2014-2016	Base	US6198	5.0L V8 304 CID	1966		US1099
<b>QX70</b>				5.0L V8 4982cc 304 CID	1966		US1099
3.7L V6 3696cc	2014-2017	Base	US8164	5.0L V8 4983cc 304 CID	1966		US1099
5.0L V8 5026cc	2014	Base	US9488	<b>1100B</b>			
<b>QX80</b>				4.3L L6 4335cc 264 CID	1967		US1099
5.6L V8 5552cc	2014-2015	Base	US9488	4.3L V8 4360cc 266 CID	1967		US1099
5.6L V8 5552cc	2016-2017	Base, Limited	US9488	5.0L V8 4982cc 304 CID	1967		US1099
5.6L V8 5552cc 339 CID	2014-2015	Base	US9488	5.6L V8 5654cc 345 CID	1967		US1099
<b>INTERNATIONAL</b>				<b>1100C</b>			
<b>100</b>				4.3L L6 4335cc 264 CID	1968		US1099
5.0L V8 304 CID	1974		US1099	4.3L V8 4360cc 266 CID	1968		US1099
5.0L V8 4982cc 304 CID	1974		US1099	5.0L V8 4982cc 304 CID	1968		US1099
5.0L V8 4983cc 304 CID	1974		US1099	5.6L V8 5654cc 345 CID	1968		US1099
5.6L V8 345 CID	1974		US1099	<b>1100D</b>			
5.6L V8 5654cc 345 CID	1974		US1099	4.3L L6 4335cc 264 CID	1969-1970		US1099
6.4L V8 392 CID	1974		US1099	4.3L V8 4360cc 266 CID	1969-1970		US1099
6.4L V8 6424cc 392 CID	1974		US1099	5.0L V8 304 CID	1969-1970		US1099
6.4L V8 6425cc 392 CID	1974		US1099	5.0L V8 4982cc 304 CID	1969-1970		US1099
<b>150</b>				5.6L V8 5654cc 345 CID	1969-1970		US1099
5.0L V8 304 CID	1975		US1099	5.7L V8 345 CID	1971-1973		US1099
5.6L V8 345 CID	1975		US1099	6.4L V8 392 CID	1972-1973		US1099
6.4L V8 392 CID	1975		US1099	6.4L V8 6424cc 392 CID	1971-1973		US1099
<b>200</b>				6.4L V8 6425cc 392 CID	1972-1973		US1099
5.0L V8 304 CID	1974-1975		US1099	<b>1200A</b>			
5.0L V8 4982cc 304 CID	1974		US1099	4.3L L6 4335cc 264 CID	1966		US1099
5.0L V8 4983cc 304 CID	1974		US1099	4.3L V8 4360cc 266 CID	1966		US1099
5.6L V8 345 CID	1974-1975		US1099	5.0L V8 304 CID	1966		US1099
5.6L V8 5654cc 345 CID	1974		US1099	5.0L V8 4982cc 304 CID	1966		US1099
6.4L V8 392 CID	1974-1975		US1099	5.0L V8 4983cc 304 CID	1966		US1099
6.4L V8 6424cc 392 CID	1974		US1099	<b>1200B</b>			
6.4L V8 6425cc 392 CID	1974		US1099	4.3L L6 4335cc 264 CID	1967		US1099
<b>900A</b>				4.3L V8 4360cc 266 CID	1967		US1099
2.5L L4 2491cc 152 CID	1966-1967		US1099	5.0L V8 4982cc 304 CID	1967		US1099
<b>908B</b>				5.0L V8 4982cc 304 CID	1967		US1099
4.3L V8 4360cc 266 CID	1967		US1099	<b>908C</b>			
5.0L V8 4982cc 304 CID	1967		US1099	4.3L V8 4360cc 266 CID	1968-1969		US1099
<b>908C</b>				5.0L V8 304 CID	1969		US1099
4.3L V8 4360cc 266 CID	1968-1969		US1099	5.0L V8 4982cc 304 CID	1968-1969		US1099
5.0L V8 304 CID	1969		US1099	5.0L V8 4983cc 304 CID	1969		US1099
5.0L V8 4982cc 304 CID	1968-1969		US1099	<b>1000A</b>			
5.0L V8 4983cc 304 CID	1969		US1099	4.3L L6 4335cc 264 CID	1966		US1099
<b>1000A</b>				4.3L V8 4360cc 266 CID	1966		US1099
4.3L L6 4335cc 264 CID	1966		US1099	5.0L V8 4982cc 304 CID	1966		US1099
4.3L V8 4360cc 266 CID	1966		US1099	<b>1000B</b>			
5.0L V8 4982cc 304 CID	1966		US1099	4.3L L6 4335cc 264 CID	1967		US1099
<b>1000B</b>				4.3L V8 4360cc 266 CID	1967		US1099
4.3L L6 4335cc 264 CID	1967		US1099	5.0L V8 4982cc 304 CID	1967		US1099
4.3L V8 4360cc 266 CID	1967		US1099	5.6L V8 5654cc 345 CID	1967		US1099
5.0L V8 4982cc 304 CID	1967		US1099	<b>1000C</b>			
5.6L V8 5654cc 345 CID	1967		US1099	4.3L L6 4335cc 264 CID	1968		US1099
<b>1000C</b>				4.3L V8 4360cc 266 CID	1968		US1099
4.3L L6 4335cc 264 CID	1968		US1099	5.0L V8 4982cc 304 CID	1968		US1099
4.3L V8 4360cc 266 CID	1968		US1099	5.6L V8 5654cc 345 CID	1968		US1099
5.0L V8 4982cc 304 CID	1968		US1099	<b>1000D</b>			
5.6L V8 5654cc 345 CID	1968		US1099	4.3L L6 4335cc 264 CID	1969-1970		US1099
<b>1000D</b>				4.3L V8 4360cc 266 CID	1969-1970		US1099
4.3L L6 4335cc 264 CID	1969-1970		US1099	5.0L V8 304 CID	1969-1970		US1099
4.3L V8 4360cc 266 CID	1969-1970		US1099	5.0L V8 4982cc 304 CID	1969-1970		US1099
5.0L V8 304 CID	1969-1970		US1099	5.6L V8 5654cc 345 CID	1969-1970		US1099
5.0L V8 4982cc 304 CID	1969-1970		US1099	6.4L V8 6424cc 392 CID	1969-1970		US1099
5.0L V8 4983cc 304 CID	1969-1970		US1099	<b>1210</b>			
5.0L V8 4983cc 304 CID	1969-1970		US1099	5.0L V8 304 CID	1972-1973		US1099
<b>1300A</b>				5.0L V8 4982cc 304 CID	1971-1973		US1099
4.3L L6 4335cc 264 CID	1966		US1099	5.0L V8 4983cc 304 CID	1972-1973		US1099
<b>1300A</b>				5.6L V8 5654cc 345 CID	1971-1973		US1099
4.3L L6 4335cc 264 CID	1966		US1099	5.7L V8 345 CID	1971-1973		US1099
<b>1300A</b>				6.4L V8 392 CID	1972-1973		US1099
4.3L L6 4335cc 264 CID	1966		US1099	6.4L V8 6424cc 392 CID	1971-1973		US1099
<b>1300A</b>				6.4L V8 6425cc 392 CID	1972-1973		US1099
4.3L L6 4335cc 264 CID	1966		US1099	<b>1300A</b>			
<b>1300A</b>				4.3L L6 4335cc 264 CID	1966		US1099

Engine	Years	Application Description	USMW	Engine	Years	Application Description	USMW
<b>INTERNATIONAL (cont'd.)</b>				<b>INTERNATIONAL (cont'd.)</b>			
<b>1300A (cont'd.)</b>				<b>M800 (cont'd.)</b>			
4.3L V8 4360cc 266 CID	1966		US1099	5.0L V8 4982cc 304 CID	1969-1971		US1099
5.0L V8 4982cc 304 CID	1966		US1099	5.0L V8 4983cc 304 CID	1969-1971		US1099
<b>1300B</b>				<b>M1100</b>			
4.3L L6 4335cc 264 CID	1967		US1099	2.5L L4 152 CID	1968		US1099
4.3L V8 4360cc 266 CID	1967		US1099	2.5L L4 152 CID	1971		US1099
5.0L V8 4982cc 304 CID	1967		US1099	2.5L L4 2491cc 152 CID	1966-1971		US1099
5.6L V8 5654cc 345 CID	1967		US1099	4.3L L6 4335cc 264 CID	1966-1970		US1099
<b>1300C</b>				<b>M1200</b>			
4.3L L6 4335cc 264 CID	1968		US1099	4.3L V8 4360cc 266 CID	1966-1970		US1099
4.3L V8 4360cc 266 CID	1968		US1099	5.0L V8 304 CID	1969-1972		US1099
5.0L V8 4982cc 304 CID	1968		US1099	5.0L V8 4982cc 304 CID	1966-1972		US1099
5.6L V8 5654cc 345 CID	1968		US1099	5.0L V8 4983cc 304 CID	1969-1972		US1099
<b>1300D</b>				<b>M1400</b>			
4.3L L6 4335cc 264 CID	1970		US1099	4.3L L6 4335cc 264 CID	1966-1967		US1099
4.3L V8 4360cc 266 CID	1970		US1099	4.3L V8 4360cc 266 CID	1966-1970		US1099
5.0L V8 304 CID	1969-1970		US1099	5.0L V8 304 CID	1969-1972		US1099
5.0L V8 4982cc 304 CID	1969-1970		US1099	5.0L V8 4982cc 304 CID	1969-1972		US1099
5.0L V8 4983cc 304 CID	1969-1970		US1099	5.0L V8 4983cc 304 CID	1969-1972		US1099
5.6L V8 5654cc 345 CID	1969-1970		US1099	<b>M1400 METRO II</b>			
6.4L V8 6424cc 392 CID	1969-1970		US1099	6.8L V8 420 CID	1987		US3705
<b>1310</b>				<b>M1600 METRO II</b>			
4.3L V8 4360cc 266 CID	1971		US1099	6.8L V8 420 CID	1987		US3705
5.0L V8 304 CID	1971-1973		US1099	7.3L V8 444 CID	1988-1990		US3705
5.0L V8 4982cc 304 CID	1971-1973		US1099	<b>MA1200</b>			
5.0L V8 4983cc 304 CID	1972-1973		US1099	4.3L V8 4360cc 266 CID	1967-1970		US1099
5.6L V8 5654cc 345 CID	1971-1973		US1099	5.0L V8 304 CID	1969-1971		US1099
5.7L V8 345 CID	1971-1973		US1099	5.0L V8 4982cc 304 CID	1967-1971		US1099
6.4L V8 392 CID	1972-1973		US1099	5.0L V8 4983cc 304 CID	1969-1971		US1099
6.4L V8 6424cc 392 CID	1971-1973		US1099	<b>MHC1310</b>			
6.4L V8 6425cc 392 CID	1972-1973		US1099	5.0L V8 304 CID	1974		US1099
<b>1652SC</b>				<b>MS</b>			
7.3L V8 444 CID	2004-2005	Medium/Heavy Duty	US66	5.6L V8 345 CID	1975		US1099
<b>1652UPS</b>				<b>MS1210</b>			
6.8L V8 420 CID	1990		US3705	6.4L V8 392 CID	1975		US1099
7.3L V8 444 CID	1990-1991		US3705	5.0L V8 304 CID	1972-1974		US1099
<b>3000</b>				<b>MS1210</b>			
7.3L V8 444 CID	1997-2000	Medium/Heavy Duty	US66	5.0L V8 4982cc 304 CID	1972-1974		US1099
<b>3000IC</b>				<b>S1654</b>			
7.3L V8 444 CID	2000-2002	Medium/Heavy Duty	US66	6.8L V8 420 CID	1984-1988		US3705
<b>3400</b>				<b>S1654LP</b>			
7.3L V8 444 CID	1996-2002	Medium/Heavy Duty	US66	7.3L V8 444 CID	1988-1989		US3705
<b>3600</b>				<b>S1723</b>			
7.3L V8 444 CID	1992-1993		US3705	6.6L V8 404 CID	1980		US3705
7.3L V8 444 CID	1994-1999	Medium/Heavy Duty	US66	<b>S1724</b>			
<b>3700</b>				<b>S1753</b>			
6.8L V8 420 CID	1991		US3705	6.6L V8 404 CID	1980		US3705
7.3L V8 444 CID	1990-1993		US3705	<b>S1753</b>			
7.3L V8 444 CID	1994	Medium/Heavy Duty	US66	6.8L V8 420 CID	1984-1988		US3705
<b>3800</b>				<b>S1754</b>			
6.8L V8 420 CID	1991		US3705	7.3L V8 444 CID	1988		US3705
7.3L V8 444 CID	1990		US3705	<b>S1823</b>			
7.3L V8 444 CID	1994-2004	Medium/Heavy Duty	US66	6.6L V8 404 CID	1980		US3705
<b>4600LP</b>				<b>S1824</b>			
7.3L V8 444 CID	1990-1993		US3705	6.6L V8 404 CID	1980		US3705
7.3L V8 444 CID	1994	Medium/Heavy Duty	US66	7.3L V8 446 CID	1980		US3705
<b>4700LP</b>				<b>S1853</b>			
7.3L V8 444 CID	1994-2002	Medium/Heavy Duty	US66	6.8L V8 420 CID	1988		US3705
<b>4700LPX</b>				<b>S1924</b>			
7.3L V8 444 CID	1995-2002	Medium/Heavy Duty	US66	7.3L V8 446 CID	1980		US3705
<b>4900</b>				<b>S1925</b>			
7.3L V8 444 CID	1991		US3705	6.6L V8 404 CID	1980		US3705
<b>CARGOSTAR</b>				<b>M800</b>			
6.6L V8 404 CID	1980		US3705	2.5L L4 152 CID	1968		US1099
6.8L V8 420 CID	1984-1986		US3705	2.5L L4 152 CID	1971		US1099
7.3L V8 446 CID	1980		US3705	2.5L L4 2491cc 152 CID	1966-1971		US1099
<b>F1954</b>				<b>5.0L V8 304 CID</b>			
6.8L V8 420 CID	1986		US3705	1969-1971			US1099
<b>GENESIS RE</b>				<b>INTERNATIONAL (cont'd.)</b>			
7.3L V8 444 CID	1996-2002	Medium/Heavy Duty	US66	<b>M800 (cont'd.)</b>			
<b>M800</b>				<b>M1100</b>			
2.5L L4 152 CID	1968		US1099	2.5L L4 152 CID	1968		US1099
2.5L L4 152 CID	1971		US1099	2.5L L4 152 CID	1971		US1099
2.5L L4 2491cc 152 CID	1966-1971		US1099	2.5L L4 2491cc 152 CID	1966-1971		US1099
5.0L V8 304 CID	1969-1971		US1099	4.3L L6 4335cc 264 CID	1966-1970		US1099

WATER PUMPS



# WATER PUMP APPLICATION GUIDE



Engine	Years	Application Description	USMW	Engine	Years	Application Description	USMW
<b>INTERNATIONAL (cont'd.)</b>				<b>ISUZU (cont'd.)</b>			
<b>S1925 (cont'd.)</b>				<b>I-MARK (cont'd.)</b>			
7.3L V8 446 CID	1980		US3705	1.5L L4 1471cc	1987	Base, S	US5031
<b>SCOUT</b>				1.5L L4 1471cc	1988	S, XS	US5031
2.5L L4 152 CID	1968-1970		US1099	1.5L L4 1471cc	1989	LS, S, XS	US5031
2.5L L4 2491cc 152 CID	1966-1971		US1099	1.6L L4 1588cc	1989	RS	US9160
4.3L L6 265 CID	1970		US1099	1.8L L4 1817cc	1981	Base, DLX	US1127
4.3L L6 4335cc 264 CID	1970		US1099	1.8L L4 1817cc	1982-1983	Base, DLX, LS	US1127
4.3L V8 4360cc 266 CID	1967-1968		US1099	1.8L L4 1817cc	1983	Base, DLX, LS; DIESEL; From 02/1983	US5027
5.0L V8 304 CID	1969-1970		US1099	1.8L L4 1817cc	1984	Base, DLX	US1127
5.0L V8 4982cc 304 CID	1969-1970		US1099	1.8L L4 1817cc	1984	Base, DLX; DIESEL	US5027
5.0L V8 4983cc 304 CID	1969-1970		US1099	1.8L L4 1817cc	1985	Base	US1127
<b>SCOUT II</b>				<b>IMPULSE</b>			
5.0L V8 304 CID	1971-1975		US1099	1.6L L4 1588cc	1990	XS	US9220
5.0L V8 4982cc 304 CID	1971-1974		US1099	1.6L L4 1588cc	1991	RS, XS	US9220
5.0L V8 4983cc 304 CID	1971-1974		US1099	1.6L L4 1588cc	1992	RS	US9220
5.6L V8 345 CID	1971		US1099	1.8L L4 1809cc 110 CID	1992	XS	US9221
5.6L V8 345 CID	1975		US1099	1.9L L4 1949cc	1983	Base	US1127
5.6L V8 5654cc 345 CID	1971-1974		US1099	1.9L L4 1949cc	1984	Base, SE	US1127
5.7L V8 345 CID	1972-1974		US1099	1.9L L4 1949cc	1985-1987	Base	US1127
6.4L V8 392 CID	1975		US1099	2.0L L4 1994cc	1985-1989	Base	US9106
<b>TRAVELALL</b>				2.0L L4 1994cc	1989		US9134
5.0L V8 304 CID	1975		US1099	2.3L L4 2254cc	1988-1989	Base	US9105
5.6L V8 345 CID	1975		US1099	<b>OASIS</b>			
6.4L V8 392 CID	1975		US1099	2.2L L4 2156cc	1996-1997	LS, S	US9209
<b>ISUZU</b>				2.3L L4 2234cc	1999	LS, S	US9209
<b>AMIGO</b>				2.3L L4 2254cc	1998	LS, S	US9209
2.2L L4 2180cc	1998-2000	S	US9375	<b>PICKUP</b>			
2.3L L4 2254cc	1989	S, XS	US9105	1.8L L4 1817cc	1981-1982	Base, DLX	US1127
2.3L L4 2254cc	1990	S, XS; From 12/1989	US9105	1.9L L4 1949cc	1983	Base, DLX, LS	US1127
2.3L L4 2254cc	1990	S, XS; To 11/1989	US9105	1.9L L4 1949cc	1984-1985	Base, DLX, LX	US1127
2.3L L4 2254cc	1991	S, XS	US9105	1.9L L4 1949cc	1986-1987	Base, DLX, LS	US1127
2.3L L4 2254cc	1992	S	US9105	2.2L L4 2238cc	1981-1982	Base, DLX	US9132
2.3L L4 2254cc	1993	S; From 07/1993	US9105	2.2L L4 2238cc	1983	Base, DLX, LS	US9132
2.3L L4 2254cc	1993	S; To 06/1993	US9105	2.2L L4 2238cc	1984-1985	Base, DLX, LX	US9132
2.6L L4 2559cc	1989	S, XS	US9133	2.2L L4 2238cc	1986-1987	Base, DLX, LS	US9132
2.6L L4 2559cc	1990	S, XS; From 12/1989	US9133	2.3L L4 2254cc	1986-1987	Base, DLX, LS	US9105
2.6L L4 2559cc	1990	S, XS; To 11/1989	US9133	2.3L L4 2254cc	1989	LS, S, XS	US9105
2.6L L4 2559cc	1991-1994	S, XS	US9133	2.3L L4 2254cc	1990	LS, S; From 12/1989	US9105
3.2L V6 3165cc	1998-2000	S	US9365	2.3L L4 2254cc	1990	LS, S; To 11/1989	US9105
<b>ASCENDER</b>				2.3L L4 2254cc	1991-1995	S	US9105
4.2L L6 256 CID	2003	Base, Limited, LS	US5097	2.6L L4 2559cc	1988	1 Ton, LS, S	US9133
4.2L L6 256 CID	2004-2005	LS, S	US5097	2.6L L4 2559cc	1989	1 Ton, LS, S, XS	US9133
4.2L L6 256 CID	2006	Base, LS	US5097	2.6L L4 2559cc	1990	1 Ton, LS, S, XS; From 12/1989	US9133
4.2L L6 256 CID	2007-2008	S	US5097	2.6L L4 2559cc	1990	1 Ton, LS, S, XS; To 11/1989	US9133
5.3L V8 5328cc 325 CID	2003	Base, Limited, LS	US64	2.6L L4 2559cc	1991-1992	1 Ton, LS, S	US9133
5.3L V8 5328cc 325 CID	2003	Base, Limited, LS; Includes thermostat and thermostat housing	US64-T	2.6L L4 2559cc	1993-1995	S	US9133
5.3L V8 5328cc 325 CID	2004	Limited, LS	US64	3.1L V6 3137cc	1991	LS, S	US5035
5.3L V8 5328cc 325 CID	2004	Limited, LS; Includes thermostat and thermostat housing	US64-T	3.1L V6 3137cc	1992-1994	S	US5035
5.3L V8 5328cc 325 CID	2005	Limited, LS, S	US64	<b>RODEO</b>			
5.3L V8 5328cc 325 CID	2005	Limited, LS, S; Includes thermostat and thermostat housing	US64-T	2.2L L4 2180cc	1998	S	US9375
5.3L V8 5328cc 325 CID	2006	LS	US64	2.2L L4 2180cc	1999-2000	LSE, S	US9375
5.3L V8 5328cc 325 CID	2006	LS; Includes thermostat and thermostat housing	US64-T	2.2L L4 2180cc	2001-2002	S	US9375
<b>AXIOM</b>				2.2L L4 2180cc	2003	LS, LSE, S	US9375
3.5L V6 3475cc	2002	Base, XS	US9365	2.6L L4 2559cc	1991	LS, S	US9133
3.5L V6 3491cc	2003	Base, XS	US9365	2.6L L4 2559cc	1992	LS, S, XS	US9133
3.5L V6 3494cc	2004	S, XS	US9365	2.6L L4 2559cc	1993-1997	LS, S	US9133
<b>FRR</b>				3.1L V6 3137cc	1991-1992	LS, S, XS	US5035
7.8L L6 475 CID	2000-2002	8 vane impeller, Medium/Heavy Duty	US73	3.2L V6 3165cc	1993-1994	LS, S	US9278
<b>HOMBRE</b>				3.2L V6 3165cc	1995	LS, S; From 01/1995	US9278
2.2L L4 2190cc 134 CID	1996-2000	S, XS	US5032	3.2L V6 3165cc	1995	LS, S; To 12/1994	US9278
4.3L V6 262 CID	2000	S, XS	US5077	3.2L V6 3165cc	1996-1997	LS, S	US9278
4.3L V6 262 CID	2000	S, XS; High performance	US5077H	3.2L V6 3165cc	1998	LS, S	US9365
4.3L V6 4294cc	1997-1999	S, XS	US5077	3.2L V6 3165cc	1999-2000	LS, LSE, S	US9365
4.3L V6 4294cc	1997-1999	S, XS; High performance	US5077H	3.2L V6 3165cc	2001-2003	LS, LSE, S V6	US9365
<b>I-280</b>				3.2L V6 3165cc	2004	S	US9365
2.8L L4 2770cc 169 CID	2006	Base	US5097	3.5L V6 3494cc	2004	S	US9365
<b>I-290</b>				<b>RODEO SPORT</b>			
2.9L L4 2921cc 178 CID	2007	LS, S	US5097	2.2L L4 2180cc	2001	S	US9375
2.9L L4 2921cc 178 CID	2008	S	US5097	2.2L L4 2180cc	2002	S; From 08/01	US9375
<b>I-350</b>				2.2L L4 2180cc	2002	S; To 07/2001	US9375
3.5L L5 3460cc 211 CID	2006	Base	US5097	2.2L L4 2180cc	2003	S	US9375
<b>I-370</b>				3.2L V6 3165cc	2001-2003	S V6	US9365
3.7L L5 3654cc 223 CID	2007-2008	LS	US5097	<b>STYLUS</b>			
<b>I-MARK</b>				1.6L L4 1588cc	1991	XS	US9220
1.5L L4 1471cc	1985	Base, DLX	US5031	1.6L L4 1588cc	1991-1993	S	US9221
1.5L L4 1471cc	1986	Base	US5031	1.8L L4 1809cc 110 CID	1992	RS	US9221



Engine	Years	Application Description	USMW	Engine	Years	Application Description	USMW
<b>ISUZU (cont'd.)</b>				<b>JAGUAR (cont'd.)</b>			
<b>TROOPER (cont'd.)</b>				<b>XJRS</b>			
2.6L L4 2559cc	1988	LS, S, XS; From 03/1988	US9133	6.0L V12 5994cc	1993	Base	US9165
2.6L L4 2559cc	1988	LS, S, XS; To 02/1988	US9133	<b>XJS</b>			
2.6L L4 2559cc	1989	LS, RS, S, XS	US9133	4.0L L6 3980cc	1993	Base; To Engine 163522	US9163
2.6L L4 2559cc	1990	RS, S	US9133	4.0L L6 3980cc	1993	Base; From Engine 163523, To Engine 196089	US9280
2.6L L4 2559cc	1991	S	US9133	4.0L L6 3980cc	1993	Base; From Engine B100136	US9356
2.8L V6 2827cc	1989	LS, S	US5035	4.0L L6 3980cc	1994	2+2, Base; To Engine 163522	US9163
2.8L V6 2827cc	1990	LS, S, XS	US5035	4.0L L6 3980cc	1994	2+2, Base; From Engine 163523, To Engine 196089	US9280
2.8L V6 2827cc	1991	LS, S, SE, XS	US5035	4.0L L6 3980cc	1994	2+2, Base; From Engine B100136	US9356
3.2L V6 3165cc	1992	LS, S	US9278	4.0L L6 3980cc	1995	2+2, Base	US9356
3.2L V6 3165cc	1993-1994	LS, RS, S	US9278	4.0L L6 3980cc	1996	2+2	US9356
3.2L V6 3165cc	1995	RS, S; From 01/1995	US9278	5.3L V12 5343cc	1976-1979		US9165
3.2L V6 3165cc	1995	RS, S; To 12/1994	US9278	5.3L V12 5343cc	1980	Base; From Engine 8S13094	US9165
3.2L V6 3165cc	1996	LS, S, SE	US9278	5.3L V12 5343cc	1980	Base; To Engine 8S13093	US9165
3.2L V6 3165cc	1997	LS, Ltd, S	US9278	5.3L V12 5343cc	1982-1986	Base	US9165
3.5L V6 3475cc	1998-1999	S	US9365	5.3L V12 5343cc	1987-1988	Base, C	US9165
3.5L V6 3475cc	2000-2002	Limited, LS, S	US9365	5.3L V12 5343cc	1989	Base, Collection Rouge	US9165
<b>VEHICROSS</b>				5.3L V12 5343cc	1990	Base, Classic Collection, Collection Rouge	US9165
3.5L V6 3475cc	1999-2001	Base	US9365	5.3L V12 5343cc	1991	Classic Collection	US9165
<b>JAGUAR</b>				5.3L V12 5343cc	1992	Base	US9165
<b>S-TYPE</b>				6.0L V12 5994cc	1994-1995	2+2, Base	US9165
3.0L V6 2968cc 181 CID	2000	Base; From Chassis/VIN L52823	US4118	<b>XK</b>			
3.0L V6 2968cc 181 CID	2000	Base; To Chassis/VIN L52822	US4118	4.2L V8 4196cc	2007-2009	Base	US4124
3.0L V6 2968cc 181 CID	2001-2002	Base	US4118	<b>XK8</b>			
3.0L V6 2968cc 181 CID	2003-2004	Base	US4129	4.0L V8 3996cc 244 CID	1997-2002	Base	US4124
3.0L V6 2968cc 181 CID	2005	Base, Sport	US4129	4.2L V8 4196cc	2003-2005	Base	US4124
3.0L V6 2968cc 181 CID	2006-2008	Base	US4129	4.2L V8 4196cc	2006	Base, Victory Edition	US4124
4.0L V8 3996cc 244 CID	2000-2002	Base	US4124	<b>XKR</b>			
4.2L V8 4196cc	2003-2004	Base, R	US4124	4.0L V8 3996cc 244 CID	2000	Base	US4124
4.2L V8 4196cc	2005	R, Sport	US4124	4.0L V8 3996cc 244 CID	2001	Base, Silverstone	US4124
4.2L V8 4196cc	2006	Base, R, VDP Edition	US4124	4.0L V8 3996cc 244 CID	2002	100, Base	US4124
4.2L V8 4196cc	2007-2008	Base, R	US4124	4.2L V8 4196cc	2003-2005	Base	US4124
<b>SUPER V8</b>				4.2L V8 4196cc	2006	Base, Victory Edition	US4124
4.2L V8 4196cc	2005	Base	US4124	4.2L V8 4196cc	2007	Base	US4124
4.2L V8 4196cc	2006	Base, Portfolio	US4124	4.2L V8 4196cc	2008-2009	Base, Portfolio	US4124
4.2L V8 4196cc	2007-2009	Base	US4124	<b>X-TYPE</b>			
<b>VANDEN PLAS</b>				2.5L V6 152 CID	2002-2005	Base	US6657
3.6L L6 3590cc	1988	Base; 80 Amp, Lucas Alternator	US9163	3.0L V6 2968cc 181 CID	2002-2004	Base	US6657
3.6L L6 3590cc	1988	Base; 90, 115 Amp, Bosch Alternator	US9163	3.0L V6 2968cc 181 CID	2005	Base, Premium, Vanden Plas	US6657
3.6L L6 3590cc	1989	Base, Majestic; 80 Amp, Lucas Alternator	US9163	3.0L V6 2968cc 181 CID	2006	Base, Sport, VDP Edition	US6657
3.6L L6 3590cc	1989	Base, Majestic; 90, 115 Amp, Bosch Alternator	US9163	3.0L V6 2968cc 181 CID	2007-2008	Base	US6657
4.0L L6 3980cc	1990	Base, Majestic	US9163	<b>JEEP</b>			
4.0L L6 3980cc	1991	Base	US9163	<b>CHEROKEE</b>			
4.0L L6 3980cc	1992	Base, Majestic	US9163	2.1L L4 126 CID	1985-1987	Base, Chief, Laredo, Pioneer	US3409
4.0L L6 3980cc	1993-1994	Base	US9280	2.4L L4 2360cc 144 CID	2014-2015	Latitude, Limited, Sport, Trailhawk	US6038
4.0L L6 3980cc	1995-1997	Base	US9356	2.4L L4 2360cc 144 CID	2016	75th Anniversary, Latitude, Limited, Overland, Sport, Trailhawk	US6038
4.0L V8 3996cc 244 CID	1998-1999	Base	US4124	2.4L L4 2360cc 144 CID	2017-2018	Latitude, Limited, Overland, Sport, Trailhawk	US6038
4.0L V8 3996cc 244 CID	2000-2003	Base, SC	US4124	2.5L L4 150 CID	1984	Base; V-Belt Drive	US3403
4.2L V8 4196cc	2004-2009	Base	US4124	2.5L L4 150 CID	1984	Base; Serpentine Belt Drive	US3413
<b>XF</b>				2.5L L4 150 CID	1984	Base; Heater fitting required, V-Belt Drive	US3414
4.2L V8 4196cc	2009	Luxury, Premium Luxury, Supercharged	US4124	2.5L L4 150 CID	1985-1988	Base, Chief, Laredo, Pioneer; V-Belt Drive	US3403
4.2L V8 4196cc	2010	Base	US4124	2.5L L4 150 CID	1985-1988	Base, Chief, Laredo, Pioneer; Serpentine Belt Drive	US3413
<b>XJ6</b>				2.5L L4 150 CID	1985-1988	Base, Chief, Laredo, Pioneer; Heater fitting required, V-Belt Drive	US3414
3.6L L6 3590cc	1988-1989	Base; 80 Amp, Lucas Alternator	US9163	2.5L L4 150 CID	1989	Base, Laredo, Pioneer, Sport; V-Belt Drive	US3403
3.6L L6 3590cc	1988-1989	Base; 90, 115 Amp, Bosch Alternator	US9163	2.5L L4 150 CID	1989	Base, Laredo, Pioneer, Sport; Serpentine Belt Drive	US3413
4.0L L6 3980cc	1990-1992	Base, Sovereign	US9163	2.5L L4 150 CID	1989	Base, Laredo, Pioneer, Sport; Heater fitting required, V-Belt Drive	US3414
4.0L L6 3980cc	1993	Base, Sovereign	US9280	2.5L L4 150 CID	1990	Base; V-Belt Drive	US3403
4.0L L6 3980cc	1994	Base	US9280	2.5L L4 150 CID	1990	Base; Serpentine Belt Drive	US3413
4.0L L6 3980cc	1995-1996	Base	US9356	2.5L L4 150 CID	1990	Base; Heater fitting required, V-Belt Drive	US3414
4.0L L6 3980cc	1997	Base, L	US9356	2.5L L4 150 CID	1991-1993	Base	US7136
4.2L L6 4235cc	1975-1979		US9211	2.5L L4 150 CID	1994-2000	SE	US7136
4.2L L6 4235cc	1980	L	US9211	2.8L V6 173 CID	1984	Base	US5006
4.2L L6 4235cc	1981	Base	US9211	2.8L V6 173 CID	1985-1986	Base, Chief, Laredo, Pioneer	US5006
4.2L L6 4235cc	1982	Base; To Chassis/VIN 330665	US9211	3.2L V6 3239cc 198 CID	2014-2015	Latitude, Limited, Trailhawk	US8114
<b>XJ8</b>				3.2L V6 3239cc 198 CID	2016	75th Anniversary, Latitude, Limited, Overland, Sport, Trailhawk	US8114
4.0L V8 3996cc 244 CID	1998-2001	Base, L	US4124	3.2L V6 3239cc 198 CID	2017-2018	Latitude, Limited, Overland, Sport, Trailhawk	US8114
4.0L V8 3996cc 244 CID	2002-2003	Base, Sport	US4124	4.0L L6 242 CID	1987-1988	Base, Chief, Laredo, Limited, Pioneer	US3412
4.2L V8 4196cc	2004	Base	US4124	4.0L L6 242 CID	1989-1990	Base, Laredo, Limited, Pioneer, Sport	US3412
4.2L V8 4196cc	2005-2009	Base, L	US4124	4.0L L6 242 CID	1991-1992	Base, Briarwood, Laredo, Limited, Sport	US3412
<b>XJ12</b>				4.0L L6 242 CID	1993	Base, Country, Sport	US3412
5.3L V12 5343cc	1975-1979		US9165				
6.0L V12 5994cc	1994-1996	Base	US9165				
<b>XJR</b>							
4.0L L6 3980cc	1995-1997	Base	US9356				
4.0L V8 3996cc 244 CID	1998-2001	Base	US4124				
4.0L V8 3996cc 244 CID	2002	100, Base	US4124				
4.0L V8 3996cc 244 CID	2003	Base	US4124				
4.2L V8 4196cc	2004-2009	Base	US4124				

WATER PUMPS

Engine	Years	Application Description	USMWW	Engine	Years	Application Description	USMWW
<b>JEEP (cont'd.)</b>				<b>JEEP (cont'd.)</b>			
<b>CHEROKEE (cont'd.)</b>				<b>CJ6 (cont'd.)</b>			
4.0L L6 242 CID	1994-1995	Country, SE, Sport	US3412	3.7L V6 225 CID	1968		US855
4.0L L6 242 CID	1996	Classic, Country, SE, Sport	US3412	3.7L V6 3687cc 225 CID	1966-1971		US855
4.0L L6 242 CID	1997	Country, SE, Sport	US3412	<b>CJ6A</b>			
4.0L L6 242 CID	1998-2001	Classic, Limited, SE, Sport	US3412	<b>CJ7</b>			
4.2L L6 258 CID	1975-1979		US1077	3.7L V6 3687cc 225 CID	1966-1968		US855
4.2L L6 258 CID	1980	Base, Wide Track	US3403	<b>CJ7</b>			
4.2L L6 258 CID	1980	Base, Wide Track; Heater fitting required, V-Belt Drive	US3414	2.5L L4 150 CID	1983	Base, Laredo, Limited, Renegade; V-Belt Drive	US3403
4.2L L6 258 CID	1981-1982	Base, Chief; V-Belt Drive	US3403	2.5L L4 150 CID	1983	Base, Laredo, Limited, Renegade; Serpentine Belt Drive	US3413
4.2L L6 258 CID	1981-1982	Base, Chief; Serpentine Belt Drive	US3413	2.5L L4 150 CID	1983	Base, Laredo, Limited, Renegade; Heater fitting required, V-Belt Drive	US3414
4.2L L6 258 CID	1981-1982	Base, Chief; Heater fitting required, V-Belt Drive	US3414	2.5L L4 150 CID	1984	Base, Renegade; V-Belt Drive	US3403
4.2L L6 258 CID	1983	Base, Chief, Pioneer; V-Belt Drive	US3403	2.5L L4 150 CID	1984	Base, Renegade; Serpentine Belt Drive	US3413
4.2L L6 258 CID	1983	Base, Chief, Pioneer; Serpentine Belt Drive	US3413	2.5L L4 150 CID	1984	Base, Renegade; Heater fitting required, V-Belt Drive	US3414
4.2L L6 258 CID	1983	Base, Chief, Pioneer; Heater fitting required, V-Belt Drive	US3414	2.5L L4 150 CID	1985-1986	Base, Laredo, Renegade; V-Belt Drive	US3403
5.9L V8 360 CID	1975-1979		US3401	2.5L L4 150 CID	1985-1986	Base, Laredo, Renegade; Serpentine Belt Drive	US3413
5.9L V8 360 CID	1975-1979	High performance	US3401H	2.5L L4 150 CID	1985-1986	Base, Laredo, Renegade; Heater fitting required, V-Belt Drive	US3414
5.9L V8 360 CID	1980	Base, Wide Track	US3401	2.5L L4 151 CID	1980	Base, Golden Hawk, Laredo, Renegade	US1107
5.9L V8 360 CID	1980	Base, Wide Track; High performance	US3401H	2.5L L4 151 CID	1981	Base, Laredo, Renegade	US1107
5.9L V8 360 CID	1981-1982	Base, Chief	US3401	2.5L L4 151 CID	1981	Base, Laredo, Renegade; V-Belt Drive	US3403
5.9L V8 360 CID	1981-1982	Base, Chief; High performance	US3401H	2.5L L4 151 CID	1981	Base, Laredo, Renegade; Serpentine Belt Drive	US3413
5.9L V8 360 CID	1983	Base, Chief, Pioneer	US3401	2.5L L4 151 CID	1981	Base, Laredo, Renegade; Heater fitting required, V-Belt Drive	US3414
5.9L V8 360 CID	1983	Base, Chief, Pioneer; High performance	US3401H	2.5L L4 151 CID	1982	Base, Laredo, Limited, Renegade; V-Belt Drive	US3403
6.6L V8 401 CID	1975-1978		US3401	2.5L L4 151 CID	1982	Base, Laredo, Limited, Renegade; Serpentine Belt Drive	US3413
6.6L V8 401 CID	1975-1978	High performance	US3401H	2.5L L4 151 CID	1982	Base, Laredo, Limited, Renegade; Heater fitting required, V-Belt Drive	US3414
<b>CJ3</b>				2.5L L4 151 CID	1982	Base, Laredo, Limited, Renegade; V-Belt Drive	US3403
3.7L V6 3687cc 225 CID	1966		US855	2.5L L4 151 CID	1982	Base, Laredo, Limited, Renegade; Serpentine Belt Drive	US3413
<b>CJ5</b>				2.5L L4 151 CID	1982	Base, Laredo, Limited, Renegade; Heater fitting required, V-Belt Drive	US3414
2.2L L4 2197cc 134 CID	1959-1971	Single groove pulley	US52	2.5L L4 151 CID	1982-1983	Base, Laredo, Limited, Renegade; V-Belt Drive	US3403
2.5L L4 151 CID	1980	Base, Golden Eagle, Laredo, Renegade	US1107	2.5L L4 151 CID	1982-1983	Base, Laredo, Limited, Renegade; Heater fitting required, V-Belt Drive	US3414
2.5L L4 151 CID	1981	Base, Laredo, Renegade; V-Belt Drive	US3403	3.8L L6 232 CID	1976-1978	Base, Laredo, Limited, Renegade	US1107
2.5L L4 151 CID	1981	Base, Laredo, Renegade; Serpentine Belt Drive	US3413	3.8L L6 3800cc 232 CID	1965-1974	Mexican Application	US1021
2.5L L4 151 CID	1981	Base, Laredo, Renegade; Heater fitting required, V-Belt Drive	US3414	3.8L L6 3800cc 232 CID	1975	Mexican Application	US1077
2.5L L4 151 CID	1981	Base, Laredo, Limited, Renegade; V-Belt Drive	US3403	4.2L L6 258 CID	1976-1979		US1077
2.5L L4 151 CID	1982-1983	Base, Laredo, Limited, Renegade; Serpentine Belt Drive	US3413	4.2L L6 258 CID	1980	Base, Golden Hawk, Laredo, Renegade	US3403
2.5L L4 151 CID	1982-1983	Base, Laredo, Limited, Renegade; Heater fitting required, V-Belt Drive	US3414	4.2L L6 258 CID	1980	Base, Golden Hawk, Laredo, Renegade; Heater fitting required, V-Belt Drive	US3414
3.7L V6 3687cc 225 CID	1966-1971		US855	4.2L L6 258 CID	1981	Base, Laredo, Renegade; V-Belt Drive	US3403
4.2L L6 258 CID	1980	Base, Golden Eagle, Laredo, Renegade; V-Belt Drive	US3403	4.2L L6 258 CID	1981	Base, Laredo, Renegade; Serpentine Belt Drive	US3413
4.2L L6 258 CID	1980	Base, Golden Eagle, Laredo, Renegade; Serpentine Belt Drive	US3413	4.2L L6 258 CID	1981	Base, Laredo, Renegade; Heater fitting required, V-Belt Drive	US3414
4.2L L6 258 CID	1980	Base, Golden Eagle, Laredo; Serpentine Belt Drive	US3413	4.2L L6 258 CID	1982-1983	Base, Laredo, Limited, Renegade; V-Belt Drive	US3403
4.2L L6 258 CID	1980	Base, Golden Eagle, Laredo, Renegade; Heater fitting required, V-Belt Drive, w/o serpentine belt drive	US3414	4.2L L6 258 CID	1982-1983	Base, Laredo, Limited, Renegade; Serpentine Belt Drive	US3413
4.2L L6 258 CID	1981	Base, Laredo, Renegade; V-Belt Drive	US3403	4.2L L6 258 CID	1984	Base, Laredo, Limited, Renegade; Heater fitting required, V-Belt Drive	US3414
4.2L L6 258 CID	1981	Base, Laredo, Renegade; Serpentine Belt Drive	US3413	4.2L L6 258 CID	1984	Base, Renegade; V-Belt Drive	US3403
4.2L L6 258 CID	1981	Base, Laredo, Renegade; Heater fitting required, V-Belt Drive	US3414	4.2L L6 258 CID	1984	Base, Renegade; Serpentine Belt Drive	US3413
4.2L L6 258 CID	1981	Base, Laredo, Renegade; Heater fitting required, V-Belt Drive	US3414	4.2L L6 258 CID	1984	Base, Renegade; Heater fitting required, V-Belt Drive	US3414
4.2L L6 258 CID	1982-1983	Base, Laredo, Limited, Renegade; V-Belt Drive	US3403	4.2L L6 258 CID	1985-1986	Base, Laredo, Renegade; V-Belt Drive	US3403
4.2L L6 258 CID	1982-1983	Base, Laredo, Limited, Renegade; Serpentine Belt Drive	US3413	4.2L L6 258 CID	1985-1986	Base, Laredo, Renegade; Serpentine Belt Drive	US3413
4.2L L6 258 CID	1982-1983	Base, Laredo, Limited, Renegade; Heater fitting required, V-Belt Drive	US3414	4.2L L6 258 CID	1985-1986	Base, Laredo, Renegade; Heater fitting required, V-Belt Drive	US3414
5.0L V8 304 CID	1980	Base, Golden Eagle, Laredo, Renegade	US3401	4.2L L6 4200cc 258 CID	1965-1974	Mexican Application	US1021
5.0L V8 304 CID	1980	Base, Golden Eagle, Laredo, Renegade; High performance	US3401H	4.2L L6 4200cc 258 CID	1975-1978	Mexican Application	US1077
5.0L V8 304 CID	1981	Base, Laredo, Renegade	US3401	4.6L L6 4600cc 282 CID	1973	Mexican Application	US1021
5.0L V8 304 CID	1981	Base, Laredo, Renegade; High performance	US3401H	4.6L L6 4600cc 282 CID	1974-1983	Mexican Application	US1077
<b>CJ5A</b>				4.6L L6 4600cc 282 CID	1980-1986	Mexican Application	US3403
3.7L V6 3687cc 225 CID	1966-1968		US855	5.0L V8 304 CID	1976-1979		US3401
<b>CJ5D</b>				5.0L V8 304 CID	1976-1979	High performance	US3401H
3.8L L6 3800cc 232 CID	1965-1971	Mexican Application	US1021	5.0L V8 304 CID	1980	Base, Golden Hawk, Laredo, Renegade	US3401
4.2L L6 4200cc 258 CID	1965-1971	Mexican Application	US1021	5.0L V8 304 CID	1980	Base, Golden Hawk, Laredo, Renegade; High performance	US3401H
4.2L L6 4200cc 258 CID	1975-1978	Mexican Application	US3403	5.0L V8 304 CID	1981	Base, Laredo, Renegade	US3401
4.2L L6 4200cc 258 CID	1984-1986	Mexican Application	US3403	5.0L V8 304 CID	1981	Base, Laredo, Renegade; High performance	US3401H
4.6L L6 4600cc 282 CID	1973-1974	Mexican Application	US1077	<b>CJ10</b>			
4.6L L6 4600cc 282 CID	1975-1986	Mexican Application	US3403	4.6L L6 4600cc 282 CID	1984-1985	Mexican Application	US3403
4.6L L6 4600cc 282 CID	1978-1983	Mexican Application	US1077	<b>COMANCHE</b>			
<b>CJ5S</b>				2.1L L4 126 CID	1986	Custom, X, XLS	US3409
3.8L L6 3800cc 232 CID	1965-1971	Mexican Application	US1021	2.1L L4 126 CID	1987	Base, Laredo, Pioneer	US3409
4.2L L6 4200cc 258 CID	1965-1971	Mexican Application	US1021	2.5L L4 150 CID	1986	Custom, X, XLS; V-Belt Drive	US3403
<b>CJ6</b>				2.5L L4 150 CID	1986	Custom, X, XLS; Serpentine Belt Drive	US3413
2.2L L4 2197cc 134 CID	1959-1971	Single groove pulley	US52	2.5L L4 150 CID	1986	Custom, X, XLS; Heater fitting required, V-Belt Drive	US3414
				2.5L L4 150 CID	1987-1988	Base, Chief, Laredo, Pioneer; V-Belt Drive	US3403

Engine	Years	Application Description	USMW	Engine	Years	Application Description	USMW
<b>JEEP (cont'd.)</b>				<b>JEEP (cont'd.)</b>			
<b>COMANCHE (cont'd.)</b>				<b>GRAND CHEROKEE (cont'd.)</b>			
2.5L L4 150 CID	1987-1988	Base, Chief, Laredo, Pioneer; Serpentine Belt Drive	US3413	4.0L L6 242 CID	2004	Laredo, Limited, Special Edition	US7164
2.5L L4 150 CID	1987-1988	Base, Chief, Laredo, Pioneer; Heater fitting required, V-Belt Drive	US3414	4.7L V8 287 CID	1999-2001	Laredo, Limited	US7163
2.5L L4 150 CID	1989-1990	Base, Pioneer; V-Belt Drive	US3403	4.7L V8 287 CID	2002	Laredo, Limited, Overland, Sport	US7163
2.5L L4 150 CID	1989-1990	Base, Pioneer; Serpentine Belt Drive	US3413	4.7L V8 287 CID	2003	Laredo, Limited, Overland	US7163
2.5L L4 150 CID	1989-1990	Base, Pioneer; Heater fitting required, V-Belt Drive	US3414	4.7L V8 287 CID	2004	Laredo, Limited, Overland, Special Edition	US7163
2.5L L4 150 CID	1991	Base, Pioneer	US7136	4.7L V8 287 CID	2005	Laredo, Limited	US7163
2.5L L4 150 CID	1992	Base	US7136	4.7L V8 287 CID	2006	65th Anniversary Edition, Laredo, Limited	US7163
2.8L V6 173 CID	1986	Custom, X, XLS	US5006	4.7L V8 287 CID	2007-2009	Laredo, Limited	US7163
4.0L L6 242 CID	1987	Base, Chief, Laredo, Pioneer	US3412	4.7L V8 4700cc 287 CID	2008	Mexican Application	US7163
4.0L L6 242 CID	1988	Base, Chief, Eliminator, Laredo, Pioneer	US3412	5.2L V8 5211cc 318 CID	1993	Base, Laredo, Limited	US7160
4.0L L6 242 CID	1989-1992	Base, Eliminator, Pioneer	US3412	5.2L V8 5211cc 318 CID	1994	Laredo, Limited, SE	US7160
<b>COMMANDER</b>				<b>GRAND CHEROKEE (cont'd.)</b>			
3.7L V6 226 CID	2006	65th Anniversary Edition, Base	US7163	5.2L V8 5211cc 318 CID	1995	Laredo, Limited, Orvis, SE	US7160
3.7L V6 226 CID	2007	Base, Sport	US7163	5.2L V8 5211cc 318 CID	1996	Laredo, Limited	US7160
3.7L V6 226 CID	2008-2010	Sport	US7163	5.2L V8 5211cc 318 CID	1997	Laredo, Limited, Orvis, TSi	US7160
4.7L V8 287 CID	2006	65th Anniversary Edition, Base, Limited	US7163	5.2L V8 5211cc 318 CID	1998	Laredo, Limited, TSi	US7160
4.7L V8 287 CID	2007	Base, Limited, Sport	US7163	5.7L V8 345 CID	2005	Limited	US8940
4.7L V8 287 CID	2008-2009	Limited, Sport	US7163	5.7L V8 345 CID	2006-2008	Limited, Overland	US8940
5.7L V8 345 CID	2006	Limited	US8940	5.7L V8 345 CID	2009	Limited, Overland	US8979
5.7L V8 345 CID	2007-2008	Limited, Overland	US8940	5.7L V8 345 CID	2010	Laredo, Limited	US8979
5.7L V8 345 CID	2009	Limited, Overland	US8979	5.7L V8 345 CID	2011	Laredo, Limited, Overland	US8971
5.7L V8 345 CID	2010	Limited, Sport	US8979	5.7L V8 345 CID	2012	Laredo, Limited, Overland, Overland Summit	US8971
5.7L V8 5654cc 345 CID	2010	Mexican Application	US8971	5.7L V8 345 CID	2013	Laredo, Limited, Overland	US8115
<b>COMMANDO</b>				<b>GRAND CHEROKEE (cont'd.)</b>			
3.7L V6 3687cc 225 CID	1966-1971		US855	5.7L V8 345 CID	2014-2016	Limited, Overland, Summit	US8115
<b>COMPASS</b>				<b>GRAND CHEROKEE (cont'd.)</b>			
2.0L L4 1998cc 122 CID	2008-2010	Sport	US6038	5.7L V8 345 CID	2017	Limited, Overland, Summit, Trailhawk	US8115
2.0L L4 1998cc 122 CID	2011	Base, Latitude	US6038	5.7L V8 345 CID	2018	High Altitude, Limited, Overland, Summit, Trailhawk	US8115
2.0L L4 1998cc 122 CID	2012-2017	Latitude, Sport	US6038	5.7L V8 5654cc 345 CID	2011-2013	Mexican Application	US8971
2.4L L4 2360cc 144 CID	2007	Limited	US6038	5.9L V8 360 CID	1998	5.9 Limited	US7160
2.4L L4 2360cc 144 CID	2008-2010	Limited, Sport	US6038	6.1L V8 6059cc 370 CID	2006-2010	SRT8	US8940
2.4L L4 2360cc 144 CID	2011	Base, Latitude, Limited	US6038	6.4L V8 6424cc 392 CID	2012	SRT8	US8971
2.4L L4 2360cc 144 CID	2012-2014	Latitude, Limited, Sport	US6038	6.4L V8 6424cc 392 CID	2013	SRT8	US8115
2.4L L4 2360cc 144 CID	2015	Altitude, High Altitude, Latitude, Limited, Sport	US6038	6.4L V8 6424cc 392 CID	2014-2018	SRT	US8115
2.4L L4 2360cc 144 CID	2016	75th Anniversary, Latitude, Sport	US6038	<b>GRAND WAGONEER</b>			
2.4L L4 2360cc 144 CID	2017-2018	Latitude, Limited, Sport, Trailhawk	US6038	4.2L L6 258 CID	1984-1985	Base, Limited; V-Belt Drive	US3403
<b>DISPATCHER</b>				<b>GRAND WAGONEER</b>			
3.7L V6 3687cc 225 CID	1966-1969		US855	4.2L L6 258 CID	1984-1985	Base, Limited; Serpentine Belt Drive	US3413
<b>DJ5</b>				<b>GRAND WAGONEER</b>			
3.7L V6 3687cc 225 CID	1966-1971		US855	4.2L L6 258 CID	1984-1985	Base, Limited; Heater fitting required, V-Belt Drive	US3414
<b>DJ6</b>				<b>GRAND WAGONEER</b>			
3.7L V6 3687cc 225 CID	1966-1968		US855	4.2L L6 258 CID	1986	Base; V-Belt Drive	US3403
<b>FC150</b>				<b>GRAND WAGONEER</b>			
3.7L L6 3704cc 226 CID	1966		US855	4.2L L6 258 CID	1986	Base; Serpentine Belt Drive	US3413
3.7L V6 3687cc 225 CID	1966		US855	4.2L L6 258 CID	1986	Base; Heater fitting required, V-Belt Drive	US3414
<b>FC170HD</b>				<b>GRAND WAGONEER</b>			
3.7L L6 3687cc 225 CID	1966		US855	5.2L V8 5211cc 318 CID	1993	Base	US7160
<b>GRAND CHEROKEE</b>				<b>GRAND WAGONEER</b>			
3.0L V6 2985cc 182 CID	2007-2009	Laredo, Limited, Overland	US6155	5.9L V8 360 CID	1984-1985	Base, Limited	US3401
3.0L V6 2987cc 182 CID	2014-2016	Limited, Overland, Summit	US8161	5.9L V8 360 CID	1984-1985	Base, Limited; High performance	US3401H
3.0L V6 2987cc 182 CID	2017	Limited, Overland, Summit, Trailhawk	US8161	5.9L V8 360 CID	1986-1991	Base	US3401
3.0L V6 2987cc 182 CID	2018	High Altitude, Limited, Overland, Summit, Trailhawk	US8161	5.9L V8 360 CID	1986-1991	Base; High performance	US3401H
3.6L V6 3604cc 220 CID	2011	Laredo, Limited, Overland	US8981	6.6L V8 401 CID	1975-1978	High performance	US3401H
3.6L V6 3604cc 220 CID	2011-2014	Mexican Application	US8981	<b>J20</b>			
3.6L V6 3604cc 220 CID	2012	Laredo, Limited, Overland, Overland Summit	US8981	4.2L L6 258 CID	1976		US1077
3.6L V6 3604cc 220 CID	2013	Laredo, Limited, Overland	US8981	5.9L V8 360 CID	1975-1979		US3401
3.6L V6 3604cc 220 CID	2014-2015	Laredo, Limited, Overland, Summit	US8981	5.9L V8 360 CID	1975-1979	High performance	US3401H
3.6L V6 3604cc 220 CID	2016	75th Anniversary, Laredo, Limited, Overland, Summit	US8160	5.9L V8 360 CID	1980-1988	Base	US3401
3.6L V6 3604cc 220 CID	2017	Laredo, Limited, Overland, Summit, Trailhawk	US8160	5.9L V8 360 CID	1980-1988	Base; High performance	US3401H
3.6L V6 3604cc 220 CID	2018	Altitude, High Altitude, Laredo, Limited, Overland, Summit, Trailhawk	US8160	6.6L V8 401 CID	1975-1978	High performance	US3401
3.7L V6 226 CID	2005	Laredo	US7163	6.6L V8 401 CID	1975-1978	High performance	US3401H
3.7L V6 226 CID	2006	65th Anniversary Edition, Laredo	US7163	<b>J100</b>			
3.7L V6 226 CID	2007-2009	Laredo	US7163	4.6L L6 4600cc 282 CID	1980-1983	Mexican Application	US1077
3.7L V6 226 CID	2010	Laredo, Limited	US7163	4.6L L6 4600cc 282 CID	1980-1986	Mexican Application	US3403
4.0L L6 242 CID	1993	Base, Laredo, Limited	US7136	<b>J162</b>			
4.0L L6 242 CID	1994	Laredo, Limited, SE	US7136	3.8L L6 3800cc 232 CID	1968-1969	Mexican Application	US1021
4.0L L6 242 CID	1995	Laredo, Limited, Orvis, SE	US7136	4.2L L6 4200cc 258 CID	1965	Mexican Application	US1021
4.0L L6 242 CID	1996	Laredo, Limited	US7136	4.2L L6 4200cc 258 CID	1968-1969	Mexican Application	US1021
4.0L L6 242 CID	1997	Laredo, Limited, Orvis, TSi	US7136	<b>J164</b>			
4.0L L6 242 CID	1998	Laredo, Limited, TSi	US7136	3.8L L6 3800cc 232 CID	1967-1972	Mexican Application	US1021
4.0L L6 242 CID	1999-2001	Laredo, Limited	US7164	4.2L L6 4200cc 258 CID	1965-1972	Mexican Application	US1021
4.0L L6 242 CID	2002	Laredo, Limited, Sport	US7164	4.6L L6 4600cc 282 CID	1973-1983	Mexican Application	US1077
4.0L L6 242 CID	2003	Laredo, Limited	US7164	4.6L L6 4600cc 282 CID	1980-1986	Mexican Application	US3403

WATER PUMPS



Engine	Years	Application Description	USMW	Engine	Years	Application Description	USMW
<b>JEEP (cont'd.)</b>				<b>JEEP (cont'd.)</b>			
<b>J164V</b>				<b>SCRAMBLER (cont'd.)</b>			
3.8L L6 3800cc 232 CID	1967-1972	Mexican Application	US1021	2.5L L4 151 CID	1982	Base, SL, SR; Heater fitting required, V-Belt Drive	US3414
4.2L L6 4200cc 258 CID	1965-1972	Mexican Application	US1021	2.5L L4 151 CID	1982-1983	Base, SL, SR	US1107
4.6L L6 4600cc 282 CID	1973-1983	Mexican Application	US1077	4.2L L6 258 CID	1981	Base; V-Belt Drive	US3403
4.6L L6 4600cc 282 CID	1980-1986	Mexican Application	US3403	4.2L L6 258 CID	1981	Base; Serpentine Belt Drive	US3413
<b>J262S</b>				4.2L L6 258 CID	1981	Base; Heater fitting required, V-Belt Drive	US3414
3.8L L6 3800cc 232 CID	1968-1969	Mexican Application	US1021	4.2L L6 258 CID	1982-1983	Base, SL, SR; V-Belt Drive	US3403
3.8L L6 3800cc 232 CID	1971	Mexican Application	US1021	4.2L L6 258 CID	1982-1983	Base, SL, SR; Serpentine Belt Drive	US3413
4.2L L6 4200cc 258 CID	1968-1969	Mexican Application	US1021	4.2L L6 258 CID	1982-1983	Base, SL, SR; Heater fitting required, V-Belt Drive	US3414
4.2L L6 4200cc 258 CID	1971	Mexican Application	US1021	4.2L L6 258 CID	1984	Base, SR; V-Belt Drive	US3403
<b>J264D</b>				4.2L L6 258 CID	1984	Base, SR; Serpentine Belt Drive	US3413
3.8L L6 3800cc 232 CID	1967	Mexican Application	US1021	4.2L L6 258 CID	1984	Base, SR; Heater fitting required, V-Belt Drive	US3414
4.2L L6 4200cc 258 CID	1965	Mexican Application	US1021	4.2L L6 258 CID	1985	Base, Laredo, Renegade; V-Belt Drive	US3403
4.2L L6 4200cc 258 CID	1967	Mexican Application	US1021	4.2L L6 258 CID	1985	Base, Laredo, Renegade; Serpentine Belt Drive	US3413
<b>J364R</b>				4.2L L6 258 CID	1985	Base, Laredo, Renegade; Heater fitting required, V-Belt Drive	US3414
3.8L L6 3800cc 232 CID	1967-1972	Mexican Application	US1021	<b>TRUCK</b>			
4.2L L6 4200cc 258 CID	1965-1972	Mexican Application	US1021	2.2L L4 2197cc 134 CID	1958-1966	Single groove pulley	US52
4.6L L6 4600cc 282 CID	1973-1979	Mexican Application	US1077	3.7L L6 3704cc 226 CID	1958-1962	Single groove pulley	US52
4.6L L6 4600cc 282 CID	1980-1984	Mexican Application	US3403	<b>UTILITY WAGON</b>			
<b>J-100</b>				3.7L L6 3704cc 226 CID	1956-1962		US470
5.7L V8 350 CID	1969-1971		US855	<b>WAGONEER</b>			
5.7L V8 5736cc 350 CID	1968-1971		US855	2.1L L4 126 CID	1985	Base, Limited	US3409
<b>J-2500</b>				2.5L L4 150 CID	1984-1987	Base, Limited; V-Belt Drive	US3403
5.7L V8 350 CID	1969-1971		US855	2.5L L4 150 CID	1984-1987	Base, Limited; Serpentine Belt Drive	US3413
5.7L V8 5736cc 350 CID	1969-1971		US855	2.5L L4 150 CID	1984-1987	Base, Limited; Heater fitting required, V-Belt Drive	US3414
<b>J-2600</b>				2.8L V6 173 CID	1984-1986	Base, Limited	US5006
5.7L V8 350 CID	1969-1970		US855	4.0L L6 242 CID	1987	Base, Limited	US3412
5.7L V8 5736cc 350 CID	1969-1971		US855	4.0L L6 242 CID	1988-1990	Limited	US3412
<b>J-2700</b>				4.2L L6 258 CID	1980	Base, Limited	US3403
5.7L V8 350 CID	1969-1970		US855	4.2L L6 258 CID	1980-1981	Base, Limited; Heater fitting required, V-Belt Drive	US3414
5.7L V8 5736cc 350 CID	1969-1970		US855	4.2L L6 258 CID	1981	Base, Limited; V-Belt Drive	US3403
<b>LIBERTY</b>				4.2L L6 258 CID	1981	Base, Limited; Serpentine Belt Drive	US3413
2.4L L4 148 CID	2002	Renegade, Sport	US7156	4.2L L6 258 CID	1982	Base, Brougham, Limited; V-Belt Drive	US3403
2.4L L4 148 CID	2003-2005	Sport	US7156	4.2L L6 258 CID	1982	Base, Brougham, Limited; Serpentine Belt Drive	US3413
3.7L V6 226 CID	2002	Limited, Sport	US7163	4.2L L6 258 CID	1982	Base, Brougham, Limited; Serpentine Belt Drive	US3413
3.7L V6 226 CID	2003-2004	Limited, Renegade, Sport	US7163	4.2L L6 258 CID	1982	Base, Brougham, Limited; Serpentine Belt Drive	US3413
3.7L V6 226 CID	2005	Limited, Renegade, Rocky Mountain Edition, Sport	US7163	4.2L L6 258 CID	1982	Base, Brougham, Limited; Heater fitting required, V-Belt Drive	US3414
3.7L V6 226 CID	2006	65th Anniversary Edition, Limited, Renegade, Sport	US7163	4.2L L6 258 CID	1982	Brougham, Limited; V-Belt Drive	US3403
3.7L V6 226 CID	2007-2009	Limited, Sport	US7163	4.2L L6 258 CID	1983	Brougham, Limited; Serpentine Belt Drive	US3413
3.7L V6 226 CID	2010-2011	Limited, Renegade, Sport	US7163	4.2L L6 258 CID	1983	Brougham, Limited; Heater fitting required, V-Belt Drive	US3414
3.7L V6 226 CID	2012	Jet, Limited, Sport	US7163	4.6L L6 4600cc 282 CID	1976-1979	Mexican Application	US1077
3.7L V6 3701cc 226 CID	2011-2013	Mexican Application	US7163	4.6L L6 4600cc 282 CID	1980-1986	Mexican Application	US3403
<b>PATRIOT</b>				5.9L V8 360 CID	1975-1979		US3401
2.0L L4 1998cc 122 CID	2007-2010	Sport	US6038	5.9L V8 360 CID	1975-1979	High performance	US3401H
2.0L L4 1998cc 122 CID	2011-2017	Latitude, Sport	US6038	5.9L V8 360 CID	1980-1981	Base, Limited	US3401
2.4L L4 2360cc 144 CID	2007-2010	Limited, Sport	US6038	5.9L V8 360 CID	1980-1981	Base, Limited; High performance	US3401H
2.4L L4 2360cc 144 CID	2010-2013	Mexican Application	US6038	5.9L V8 360 CID	1982	Base, Brougham, Limited	US3401
2.4L L4 2360cc 144 CID	2011	Latitude, Latitude X, Sport	US6038	5.9L V8 360 CID	1982	Base, Brougham, Limited; High performance	US3401H
2.4L L4 2360cc 144 CID	2012-2015	Latitude, Limited, Sport	US6038	5.9L V8 360 CID	1983	Brougham, Limited	US3401
2.4L L4 2360cc 144 CID	2016	75th Anniversary, Latitude, Sport	US6038	5.9L V8 360 CID	1983	Brougham, Limited; High performance	US3401H
2.4L L4 2360cc 144 CID	2017	Latitude, Sport	US6038	6.6L V8 401 CID	1975-1978		US3401
<b>RENEGADE</b>				6.6L V8 401 CID	1975-1978	High performance	US3401H
1.4L L4 1368cc 83 CID	2015	Latitude, Sport	US8136	<b>WRANGLER</b>			
1.4L L4 1368cc 83 CID	2016	75th Anniversary, Latitude, Sport	US8136	2.4L L4 148 CID	2003-2006	SE	US7156
1.4L L4 1368cc 83 CID	2017	Latitude, Sport	US8136	2.5L L4 150 CID	1987	Base, Laredo, Sport; V-Belt Drive	US3403
2.4L L4 2360cc 144 CID	2015	Latitude, Limited, Sport, Trailhawk	US6038	2.5L L4 150 CID	1987	Base, Laredo, Sport; Serpentine Belt Drive	US3413
2.4L L4 2360cc 144 CID	2016	75th Anniversary, Dawn Of Justice, Latitude, Limited, Sport, Trailhawk	US6038	2.5L L4 150 CID	1987	Base, Laredo, Sport; Heater fitting required, V-Belt Drive	US3414
2.4L L4 2360cc 144 CID	2017-2018	Latitude, Limited, Sport, Trailhawk	US6038	2.5L L4 150 CID	1988	Base, Laredo, S, Sahara, Sport; V-Belt Drive	US3403
<b>SCRAMBLER</b>				2.5L L4 150 CID	1988	Base, Laredo, S, Sahara, Sport; Serpentine Belt Drive	US3413
2.5L L4 150 CID	1983	Base, SL, SR; V-Belt Drive	US3403	2.5L L4 150 CID	1988	Base, Laredo, S, Sahara, Sport; Heater fitting required, V-Belt Drive	US3414
2.5L L4 150 CID	1983	Base, SL, SR; Serpentine Belt Drive	US3413	2.5L L4 150 CID	1989-1990	Base, Islander, Sahara; V-Belt Drive	US3403
2.5L L4 150 CID	1983	Base, SL, SR; Heater fitting required, V-Belt Drive	US3414	2.5L L4 150 CID	1989-1990	Base, Islander, Sahara; Serpentine Belt Drive	US3413
2.5L L4 150 CID	1984	Base, SR; V-Belt Drive	US3403	2.5L L4 150 CID	1989-1990	Base, Islander, Sahara; Heater fitting required, V-Belt Drive	US3414
2.5L L4 150 CID	1984	Base, SR; Serpentine Belt Drive	US3413	2.5L L4 150 CID	1991	Base, Islander, S, Sahara	US7136
2.5L L4 150 CID	1984	Base, SR; Heater fitting required, V-Belt Drive	US3414	2.5L L4 150 CID	1992-1993	Base, S	US7136
2.5L L4 150 CID	1985	Base, Laredo, Renegade; V-Belt Drive	US3403	2.5L L4 150 CID	1994	S	US7136
2.5L L4 150 CID	1985	Base, Laredo, Renegade; Serpentine Belt Drive	US3413	2.5L L4 150 CID	1995	Rio Grande	US7136
2.5L L4 150 CID	1985	Base, Laredo, Renegade; Heater fitting required, V-Belt Drive	US3414	2.5L L4 150 CID	1997-2002	SE	US7136
2.5L L4 151 CID	1981	Base	US1107	3.6L L6 3604cc 220 CID	2012	Mexican Application	US6699
2.5L L4 151 CID	1981	Base; V-Belt Drive	US3403				
2.5L L4 151 CID	1981	Base; Serpentine Belt Drive	US3413				
2.5L L4 151 CID	1981	Base; Heater fitting required, V-Belt Drive	US3414				
2.5L L4 151 CID	1982	Base, SL, SR; V-Belt Drive	US3403				
2.5L L4 151 CID	1982	Base, SL, SR; Serpentine Belt Drive	US3413				

Engine	Years	Application Description	USMW	Engine	Years	Application Description	USMW
<b>JEEP (cont'd.)</b>				<b>KIA (cont'd.)</b>			
<b>WRANGLER (cont'd.)</b>				<b>FORTE KOUP (cont'd.)</b>			
3.6L V6 3604cc 220 CID	2012-2015	Rubicon, Sahara, Sport, Unlimited Rubicon, Unlimited Sahara, Unlimited Sport	<b>US6699</b>	2.4L L4 2359cc	2010	SX; To 12/28/2009	<b>US6220</b>
3.6L V6 3604cc 220 CID	2016	75th Anniversary, Rubicon, Sahara, Sport, Sport S, Unlimited 75th Anniversary, Unlimited Rubicon, Unlimited Sahara, Unlimited Sport, Unlimited Sport S	<b>US6699</b>	2.4L L4 2359cc	2011-2013	SX	<b>US6220</b>
3.6L V6 3604cc 220 CID	2017	Rubicon, Sahara, Sport, Unlimited Rubicon, Unlimited Sahara, Unlimited Sport	<b>US6699</b>	<b>K900</b>			
3.8L V6 3778cc 231 CID	2007-2009	Rubicon, Sahara, Unlimited Rubicon, Unlimited Sahara, Unlimited X, X	<b>US8960</b>	3.8L V6 3778cc	2016-2017	V6 Luxury, V6 Premium	<b>US6048</b>
3.8L V6 3778cc 231 CID	2010	Mexican Application	<b>US8960</b>	<b>OPTIMA</b>			
3.8L V6 3778cc 231 CID	2010	Rubicon, Sahara, Sport, Unlimited Rubicon, Unlimited Sahara, Unlimited Sport, Unlimited X, X	<b>US8960</b>	1.6L L4 1591cc 97 CID	2016-2017	LX 1.6T	<b>US6247</b>
3.8L V6 3778cc 231 CID	2011	70th Anniversary, Rubicon, Sahara, Sport, Unlimited 70th Anniversary, Unlimited Rubicon, Unlimited Sahara, Unlimited Sport	<b>US8960</b>	2.0L L4 1998cc 122 CID	2011-2012	EX, SX	<b>US6220</b>
4.0L L6 242 CID	1991-1992	Base, Islander, Renegade, Sahara	<b>US7136</b>	2.0L L4 1998cc 122 CID	2013	EX, SX, SXL	<b>US6220</b>
4.0L L6 242 CID	1993	Base, Renegade, Sahara	<b>US7136</b>	2.0L L4 1998cc 122 CID	2014-2015	Limited, SXL Turbo, SX Turbo	<b>US6220</b>
4.0L L6 242 CID	1994	Renegade, Sahara, SE	<b>US7136</b>	2.0L L4 1998cc 122 CID	2016-2017	SX, SX Limited	<b>US8163</b>
4.0L L6 242 CID	1995	Sahara, SE	<b>US7136</b>	2.0L L4 1998cc 122 CID	2016-2017	SX, SX Limited; Pump only	<b>US8163</b>
4.0L L6 242 CID	1997-1999	Sahara, Sport	<b>US7136</b>	2.4L L4 2351cc	2001-2003	LX, SE	<b>US9399</b>
4.0L L6 242 CID	2000-2001	Sahara, Sport	<b>US7164</b>	2.4L L4 2351cc	2004-2006	EX, LX	<b>US9399</b>
4.0L L6 242 CID	2002	Sahara, Sport, X	<b>US7164</b>	2.4L L4 2359cc	2006-2008	EX, LX	<b>US6220</b>
4.0L L6 242 CID	2003	Rubicon, Sahara, Sport, X	<b>US7164</b>	2.4L L4 2359cc	2009-2010	EX, LX, SX	<b>US6220</b>
4.0L L6 242 CID	2004	Rubicon, Sahara, Sport, Unlimited, X	<b>US7164</b>	2.4L L4 2359cc	2011-2013	EX, LX	<b>US8982</b>
4.0L L6 242 CID	2005	Rubicon, Sport, Unlimited, Unlimited Rubicon, X	<b>US7164</b>	2.4L L4 2359cc	2014-2015	EX, LX, SX; Korea Built Vehicle	<b>US6220</b>
4.0L L6 242 CID	2006	65th Anniversary Edition, Rubicon, SE, Sport, Unlimited, Unlimited Rubicon, X	<b>US7164</b>	2.4L L4 2359cc	2014-2015	EX, LX, SX	<b>US8982</b>
4.2L L6 258 CID	1987	Base, Laredo, Sport; V-Belt Drive	<b>US3403</b>	2.4L L4 2359cc	2014-2015	EX, LX, SX; USA Built Vehicle	<b>US8982</b>
4.2L L6 258 CID	1987	Base, Laredo, Sport; Serpentine Belt Drive	<b>US3413</b>	2.4L L4 2359cc	2016-2017	EX, LX	<b>US8163</b>
4.2L L6 258 CID	1987	Base, Laredo, Sport; Heater fitting required, V-Belt Drive	<b>US3414</b>	2.4L L4 2359cc	2016-2017	EX, LX; Pump only	<b>US8163</b>
4.2L L6 258 CID	1988	Base, Islander, Laredo, S, Sahara, Sport; V-Belt Drive	<b>US3403</b>	2.5L V6 2500cc	2001	LX, SE	<b>US9462</b>
4.2L L6 258 CID	1988	Base, Islander, Laredo, S, Sahara, Sport; Serpentine Belt Drive	<b>US3413</b>	2.7L V6 2656cc	2002-2003	LX, SE	<b>US9462</b>
4.2L L6 258 CID	1988	Base, Islander, Laredo, S, Sahara, Sport; Heater fitting required, V-Belt Drive	<b>US3414</b>	2.7L V6 2656cc	2004-2006	EX, LX	<b>US9462</b>
4.2L L6 258 CID	1989-1990	Base, Islander, Laredo, Sahara; V-Belt Drive	<b>US3403</b>	2.7L V6 2656cc	2006-2008	EX, LX	<b>US6215</b>
4.2L L6 258 CID	1989-1990	Base, Islander, Laredo, Sahara; Serpentine Belt Drive	<b>US3413</b>	2.7L V6 2656cc	2009-2010	EX, LX, SX	<b>US6215</b>
4.2L L6 258 CID	1989-1990	Base, Islander, Laredo, Sahara; Heater fitting required, V-Belt Drive	<b>US3414</b>	<b>RIO</b>			
<b>KIA</b>				1.5L L4 1493cc	2001	Base	<b>US9473</b>
<b>AMANTI</b>				1.5L L4 1493cc	2002	Base, Cinco	<b>US9473</b>
3.5L V6 3497cc	2004-2006	Base	<b>US9463</b>	1.6L L4 1591cc 97 CID	2012-2017	EX, LX, SX	<b>US6247</b>
3.8L V6 3778cc	2007-2009	Base	<b>US6048</b>	1.6L L4 1594cc	2003-2005	Base, Cinco	<b>US9473</b>
<b>BORREGO</b>				1.6L L4 1599cc	2006	Base, LX	<b>US9364</b>
3.8L V6 3778cc	2009	EX, LX	<b>US6048</b>	1.6L L4 1599cc	2007-2011	Base, LX, SX	<b>US9364</b>
<b>CADENZA</b>				<b>RIO5</b>			
3.3L V6 3342cc	2014	Limited, Premium; From 04/11/2013	<b>US6048</b>	1.6L L4 1599cc	2006-2007	SX	<b>US9364</b>
3.3L V6 3342cc	2014	Limited, Premium; To 04/11/2013	<b>US6048</b>	1.6L L4 1599cc	2008-2011	LX, SX	<b>US9364</b>
3.3L V6 3342cc	2014-2015	Limited, Premium	<b>US6048</b>	<b>RONDO</b>			
3.3L V6 3342cc	2016	Base, Limited, Premium	<b>US6048</b>	2.4L L4 2359cc	2007-2008	EX, LX	<b>US6220</b>
<b>FORTE</b>				2.4L L4 2359cc	2009	EX, LX; From 10/14/2008	<b>US6220</b>
1.8L L4 1797cc	2014-2016	LX	<b>US8106</b>	2.4L L4 2359cc	2009	EX, LX; To 10/14/2008	<b>US6220</b>
2.0L L4 1998cc 122 CID	2010	EX, LX; From 12/28/2009	<b>US6220</b>	2.4L L4 2359cc	2010	EX, LX	<b>US6220</b>
2.0L L4 1998cc 122 CID	2010	EX, LX; To 12/28/2009	<b>US6220</b>	2.7L V6 2656cc	2007-2010	EX, LX	<b>US6215</b>
2.0L L4 1998cc 122 CID	2011-2012	EX, LX	<b>US6220</b>	<b>SEDONA</b>			
2.0L L4 1998cc 122 CID	2013	EX	<b>US6220</b>	3.3L V6 3342cc	2015	EX, L, Limited, LX, SX, SXL	<b>US6048</b>
2.0L L4 1999cc 122 CID	2014-2016	EX	<b>US8106</b>	3.3L V6 3342cc	2016-2017	EX, L, LX, SX, SXL	<b>US6048</b>
2.0L L4 1999cc 122 CID	2017	EX; Exc.Mexico Built Vehicle	<b>US8106</b>	3.5L V6 3470cc	2011-2012	EX, LX	<b>US6048</b>
2.4L L4 2359cc	2010	SX; From 12/28/2009	<b>US6220</b>	3.5L V6 3470cc	2014	EX, LX	<b>US6048</b>
2.4L L4 2359cc	2010	SX; To 12/28/2009	<b>US6220</b>	3.5L V6 3497cc	2002-2005	EX, LX	<b>US9463</b>
2.4L L4 2359cc	2011-2013	SX	<b>US6220</b>	3.8L V6 3778cc	2006	EX, LX	<b>US6048</b>
<b>FORTE5</b>				3.8L V6 3778cc	2007-2009	Base, EX, LX	<b>US6048</b>
1.6L L4 1591cc 97 CID	2014-2016	SX	<b>US6247</b>	3.8L V6 3778cc	2010	Base, EX, LX; From 11/03/2009	<b>US6048</b>
1.6L L4 1591cc 97 CID	2017	SX; Exc.Mexico Built Vehicle	<b>US6247</b>	3.8L V6 3778cc	2010	Base, EX, LX; To 11/03/2009	<b>US6048</b>
2.0L L4 1999cc 122 CID	2014-2015	EX	<b>US8106</b>	<b>SEPHIA</b>			
2.0L L4 1999cc 122 CID	2016	EX, LX	<b>US8106</b>	1.6L L4 1597cc	1994	GS, LS, RS	<b>US4049</b>
2.0L L4 1999cc 122 CID	2017	EX, LX; Exc.Mexico Built Vehicle	<b>US8106</b>	1.6L L4 1597cc	1995	GS, LS, RS; (1)	<b>US4049</b>
<b>FORTE KOUP</b>				1.6L L4 1597cc	1995	GS, LS, RS; (3)	<b>US9305</b>
1.6L L4 1591cc 97 CID	2014-2016	SX	<b>US6247</b>	1.6L L4 1597cc	1996	GS, LS, RS	<b>US9305</b>
2.0L L4 1998cc 122 CID	2010	EX; From 12/28/2009	<b>US6220</b>	1.6L L4 1597cc	1997	LS, RS	<b>US9305</b>
2.0L L4 1998cc 122 CID	2010	EX; To 12/28/2009	<b>US6220</b>	1.8L L4 1793cc	1998-2001	Base, LS	<b>US9393</b>
2.0L L4 1998cc 122 CID	2011-2013	EX	<b>US6220</b>	1.8L L4 1839cc	1995	GS, LS	<b>US9305</b>
2.0L L4 1999cc 122 CID	2014-2016	EX	<b>US8106</b>	1.8L L4 1839cc	1996-1997	GS, LS, RS	<b>US9305</b>
2.0L L4 2359cc	2010	SX; From 12/28/2009	<b>US6220</b>	<b>SORENTO</b>			
2.0L L4 2359cc	2010	SX; To 12/28/2009	<b>US6220</b>	2.0L L4 1998cc 122 CID	2016	EX, Limited	<b>US8163</b>
2.4L L4 2359cc	2011-2013	SX	<b>US6220</b>	2.0L L4 1998cc 122 CID	2016	EX, Limited; Pump only	<b>US8163</b>
<b>WRANGLER (cont'd.)</b>				2.0L L4 1998cc 122 CID	2017	EX	<b>US8163</b>
3.6L V6 3604cc 220 CID	2012-2015	Rubicon, Sahara, Sport, Unlimited Rubicon, Unlimited Sahara, Unlimited Sport	<b>US6699</b>	2.0L L4 1998cc 122 CID	2017	EX; Pump only	<b>US8163</b>
3.6L V6 3604cc 220 CID	2016	75th Anniversary, Rubicon, Sahara, Sport, Sport S, Unlimited 75th Anniversary, Unlimited Rubicon, Unlimited Sahara, Unlimited Sport, Unlimited Sport S	<b>US6699</b>	2.4L L4 2359cc	2011	Base, EX, LX	<b>US6220</b>
3.6L V6 3604cc 220 CID	2017	Rubicon, Sahara, Sport, Unlimited Rubicon, Unlimited Sahara, Unlimited Sport	<b>US6699</b>	2.4L L4 2359cc	2012	Base	<b>US6220</b>
3.8L V6 3778cc 231 CID	2007-2009	Rubicon, Sahara, Unlimited Rubicon, Unlimited Sahara, Unlimited X, X	<b>US8960</b>	2.4L L4 2359cc	2012-2013	LX; (1)	<b>US6220</b>
3.8L V6 3778cc 231 CID	2010	Mexican Application	<b>US8960</b>	2.4L L4 2359cc	2012-2013	EX	<b>US8982</b>
3.8L V6 3778cc 231 CID	2010	Rubicon, Sahara, Sport, Unlimited Rubicon, Unlimited Sahara, Unlimited Sport, Unlimited X, X	<b>US8960</b>	2.4L L4 2359cc	2012-2013	LX; (6)	<b>US8982</b>
3.8L V6 3778cc 231 CID	2011	70th Anniversary, Rubicon, Sahara, Sport, Unlimited 70th Anniversary, Unlimited Rubicon, Unlimited Sahara, Unlimited Sport	<b>US8960</b>	2.4L L4 2359cc	2014-2015	LX	<b>US8982</b>
4.0L L6 242 CID	1991-1992	Base, Islander, Renegade, Sahara	<b>US7136</b>	2.4L L4 2359cc	2016-2017	L, LX	<b>US8163</b>
4.0L L6 242 CID	1993	Base, Renegade, Sahara	<b>US7136</b>	2.4L L4 2359cc	2016-2017	L, LX; Pump only	<b>US8163</b>
4.0L L6 242 CID	1994	Renegade, Sahara, SE	<b>US7136</b>	3.3L V6 3342cc	2008-2009	Base, LX	<b>US6048</b>
4.0L L6 242 CID	1995	Sahara, SE	<b>US7136</b>	3.3L V6 3342cc	2014	EX, Limited, LX, SX; From 04/11/2013	<b>US6048</b>
4.0L L6 242 CID	1997-1999	Sahara, Sport	<b>US7136</b>	3.3L V6 3342cc	2014	EX, Limited, LX, SX; To 04/11/2013	<b>US6048</b>
4.0L L6 242 CID	2000-2001	Sahara, Sport	<b>US7164</b>	3.3L V6 3342cc	2014-2016	EX, Limited, LX, SX	<b>US6048</b>
4.0L L6 242 CID	2002	Sahara, Sport, X	<b>US7164</b>	3.3L V6 3342cc	2017	EX, LX, SX	<b>US6048</b>
4.0L L6 242 CID	2003	Rubicon, Sahara, Sport, X	<b>US7164</b>	3.5L V6 3470cc	2011-2013	EX, LX, SX	<b>US6048</b>
4.0L L6 242 CID	2004	Rubicon, Sahara, Sport, Unlimited, X	<b>US7164</b>	3.5L V6 3497cc	2003-2006	EX, LX	<b>US9448</b>
4.0L L6 242 CID	2005	Rubicon, Sport, Unlimited, Unlimited Rubicon, X	<b>US7164</b>				
4.0L L6 242 CID	2006	65th Anniversary Edition, Rubicon, SE, Sport, Unlimited, Unlimited Rubicon, X	<b>US7164</b>				
4.2L L6 258 CID	1987	Base, Laredo, Sport; V-Belt Drive	<b>US3403</b>				
4.2L L6 258 CID	1987	Base, Laredo, Sport; Serpentine Belt Drive	<b>US3413</b>				
4.2L L6 258 CID	1987	Base, Laredo, Sport; Heater fitting required, V-Belt Drive	<b>US3414</b>				
4.2L L6 258 CID	1988	Base, Islander, Laredo, S, Sahara, Sport; V-Belt Drive	<b>US3403</b>				
4.2L L6 258 CID	1988	Base, Islander, Laredo, S, Sahara, Sport; Serpentine Belt Drive	<b>US3413</b>				
4.2L L6 258 CID	1988	Base, Islander, Laredo, S, Sahara, Sport; Heater fitting required, V-Belt Drive	<b>US3414</b>				
4.2L L6 258 CID	1989-1990	Base, Islander, Laredo, Sahara; V-Belt Drive	<b>US3403</b>				
4.2L L6 258 CID	1989-1990	Base, Islander, Laredo, Sahara; Serpentine Belt Drive	<b>US3413</b>				
4.2L L6 258 CID	1989-1990	Base, Islander, Laredo, Sahara; Heater fitting required, V-Belt Drive	<b>US3414</b>				

WATER PUMPS

Engine	Years	Application Description	USMW	Engine	Years	Application Description	USMW
<b>KIA (cont'd.)</b>				<b>LAND ROVER (cont'd.)</b>			
<b>SORENTO (cont'd.)</b>				<b>RANGE ROVER (cont'd.)</b>			
3.8L V6 3778cc	2007	Base, EX, LX	<b>US6048</b>	3.9L V8 3950cc	1993	County, Sport; From Engine 36D25155B	<b>US9369</b>
3.8L V6 3778cc	2008-2009	EX	<b>US6048</b>	3.9L V8 3950cc	1994	County; To Engine 36D25155B	<b>US9368</b>
<b>SOUL</b>				3.9L V8 3950cc	1994	County; From Engine 36D25155B	<b>US9369</b>
1.6L L4 1591cc	2010	Base; From 12/21/2009	<b>US6247</b>	3.9L V8 3950cc	1995	County Classic; To Engine 36D25155B	<b>US9368</b>
1.6L L4 1591cc	2010	Base; To 12/21/2009	<b>US6247</b>	3.9L V8 3950cc	1995	County Classic; From Engine 36D25155B	<b>US9369</b>
1.6L L4 1591cc	2011-2016	Base	<b>US6247</b>	4.0L V8 3950cc	1995-1997	SE	<b>US9369</b>
1.6L L4 1591cc	2017	I, Base	<b>US6247</b>	4.0L V8 3950cc	1998	50th Anniversary Edition, SE	<b>US9369</b>
2.0L L4 1975cc	2010-2011	I, +, Sport	<b>US8972</b>	4.0L V8 3950cc	1999	Base, S, SE	<b>US9369</b>
2.0L L4 1999cc 122 CID	2012	I, +	<b>US8106</b>	4.0L V8 3950cc	2000	Base, County, SE	<b>US9369</b>
2.0L L4 1999cc 122 CID	2013	I, +, 4u Luxury	<b>US8106</b>	4.2L V8 4196cc	2006-2009	Supercharged	<b>US4124</b>
2.0L L4 1999cc 122 CID	2014-2016	I, +	<b>US8106</b>	4.2L V8 4200cc	1993-1994	County LWB; To Engine 40D09582B	<b>US9368</b>
2.0L L4 1999cc 122 CID	2017	+	<b>US8106</b>	4.2L V8 4200cc	1993-1994	County LWB; From Engine 40D09582B	<b>US9369</b>
<b>SPECTRA</b>				4.2L V8 4200cc	1995	25th Anniversary Edition, County LWB; To Engine 40D09582B	<b>US9368</b>
1.8L L4 1793cc	2000-2001	GS, GSX	<b>US9393</b>	4.2L V8 4200cc	1995	25th Anniversary Edition, County LWB; From Engine 40D09582B	<b>US9369</b>
1.8L L4 1793cc	2002	Base, GS, GSX, LS; From 12/13/2001	<b>US9393</b>	4.4L V8 4394cc	2006-2009	HSE	<b>US4124</b>
1.8L L4 1793cc	2002	Base, GS, GSX, LS; To 12/13/2001	<b>US9393</b>	4.6L V8 4554cc 278 CID	1996	HSE	<b>US9369</b>
1.8L L4 1793cc	2003-2004	Base, GS, GSX, LS	<b>US9393</b>	4.6L V8 4554cc 278 CID	1997	HSE, Kensington, Vitesse	<b>US9369</b>
2.0L L4 1975cc	2004	EX, LX	<b>US8972</b>	4.6L V8 4554cc 278 CID	1998	HSE	<b>US9369</b>
2.0L L4 1975cc	2005	EX, LX, SX	<b>US8972</b>	4.6L V8 4554cc 278 CID	1999	Callaway, HSE	<b>US9369</b>
2.0L L4 1975cc	2006	EX, SX	<b>US8972</b>	4.6L V8 4554cc 278 CID	2000	HSE, HSK, Vitesse	<b>US9369</b>
2.0L L4 1975cc	2007-2009	EX, LX, SX	<b>US8972</b>	4.6L V8 4554cc 278 CID	2001	HSE, SE	<b>US9369</b>
<b>SPECTRA5</b>				4.6L V8 4554cc 278 CID	2002	HSE	<b>US9369</b>
2.0L L4 1975cc	2005-2006	Base	<b>US8972</b>	5.0L V8 5000cc	2010-2011	HSE, Supercharged	<b>US8120</b>
2.0L L4 1975cc	2007-2009	SX	<b>US8972</b>	5.0L V8 5000cc	2012	Autobiography, HSE, HSE Lux, Supercharged	<b>US8120</b>
<b>SPORTAGE</b>				5.0L V8 5000cc	2013	Autobiography, Base, HSE, Supercharged	<b>US8120</b>
2.0L L4 1975cc	2005-2010	LX	<b>US8972</b>	5.0L V8 5000cc 305 CID	2014	Autobiography, Autobiography Black, Supercharged	<b>US8120</b>
2.0L L4 1998cc 122 CID	1995	Base, EX	<b>US4053</b>	5.0L V8 5000cc 305 CID	2015	Autobiography, Supercharged	<b>US8120</b>
2.0L L4 1998cc 122 CID	1995-2000	Base, EX	<b>US9450</b>	5.0L V8 5000cc 305 CID	2016-2017	Autobiography, Supercharged, SV Autobiography	<b>US8120</b>
2.0L L4 1998cc 122 CID	2001	Base, EX, Limited	<b>US9450</b>	<b>RANGE ROVER EVOQUE</b>			
2.0L L4 1998cc 122 CID	2002	Base	<b>US9450</b>	2.0L L4 1999cc 122 CID	2012	Dynamic, Prestige, Pure	<b>US8120</b>
2.0L L4 1998cc 122 CID	2011-2016	SX	<b>US6220</b>	<b>RANGE ROVER SPORT</b>			
2.0L L4 1998cc 122 CID	2017	SX Turbo	<b>US8163</b>	3.0L V6 2995cc 183 CID	2014-2016	HSE, SE	<b>US8120</b>
2.4L L4 2359cc	2011-2013	Base, EX, LX	<b>US8982</b>	3.0L V6 2995cc 183 CID	2017	HSE, HSE Dynamic, SE	<b>US8120</b>
2.4L L4 2359cc	2014-2016	EX, LX	<b>US6220</b>	4.2L V8 4196cc	2006-2007	Supercharged	<b>US4124</b>
2.4L L4 2359cc	2014-2016	EX, LX	<b>US8982</b>	4.2L V8 4196cc	2008	LE, Supercharged	<b>US4124</b>
2.4L L4 2359cc	2017	EX, LX	<b>US8163</b>	4.2L V8 4196cc	2009	Supercharged	<b>US4124</b>
2.7L V6 2656cc	2005-2010	EX, LX	<b>US9462</b>	4.4L V8 4394cc	2006-2009	HSE	<b>US4124</b>
<b>LAND ROVER</b>				5.0L V8 5000cc	2010	HSE, Supercharged	<b>US8120</b>
<b>DEFENDER 90</b>				5.0L V8 5000cc	2011	Autobiography, GT Limited Edition, HSE, Supercharged	<b>US8120</b>
3.9L V8 3950cc	1994-1995	Base	<b>US9368</b>	5.0L V8 5000cc	2012	Autobiography, GT Limited Edition 3, HSE, HSE Lux, Supercharged	<b>US8120</b>
4.0L V8 3950cc	1997	Base, LE	<b>US9369</b>	5.0L V8 5000cc	2013	Autobiography, GT Limited Edition, HSE, HSE Lux, Supercharged	<b>US8120</b>
<b>DEFENDER 110</b>				5.0L V8 5000cc 305 CID	2014	Autobiography, Supercharged	<b>US8120</b>
3.9L V8 3950cc	1993	Base	<b>US9368</b>	5.0L V8 5000cc 305 CID	2015	Autobiography, Supercharged, SVR	<b>US8120</b>
<b>DISCOVERY</b>				5.0L V8 5000cc 305 CID	2016	Autobiography, Supercharged, Supercharged Dynamic, SVR	<b>US8120</b>
3.0L V6 2995cc 183 CID	2017	First Edition, HSE, HSE Luxury, SE	<b>US8120</b>	5.0L V8 5000cc 305 CID	2017	Autobiography, Supercharged, SVR	<b>US8120</b>
3.9L V8 3950cc	1994-1995	Base	<b>US9369</b>	<b>LEXUS</b>			
4.0L V8 3950cc	1996	SD, SE, SE7	<b>US9369</b>	<b>CT200H</b>			
4.0L V8 3950cc	1997	LSE, SD, SE, SE7, XD	<b>US9369</b>	1.8L L4 1798cc 110 CID	2011-2012		<b>US6682</b>
4.0L V8 3950cc	1998	50th Anniversary Edition, LE, LSE	<b>US9369</b>	1.8L L4 1798cc 110 CID	2013	Base	<b>US6682</b>
4.0L V8 3950cc	1999	SD, Series II	<b>US9369</b>	1.8L L4 1798cc 110 CID	2014-2017	Base, F Sport	<b>US6682</b>
4.0L V8 3950cc	2000	Series II	<b>US9369</b>	<b>ES250</b>			
4.0L V8 3950cc	2001	Series II LE, Series II SD, Series II SE	<b>US9369</b>	2.5L V6 2508cc	1990-1991	Base	<b>US9258</b>
4.0L V8 3950cc	2002	Series II SD, Series II SE	<b>US9369</b>	<b>ES300</b>			
4.6L V8 4554cc 278 CID	2003-2004	HSE, S, SE	<b>US9369</b>	3.0L V6 2959cc	1992-1993	Base	<b>US9258</b>
<b>FREELANDER</b>				3.0L V6 2959cc	1996-1998	Base	<b>US9306</b>
2.5L V6 2500cc 153 CID	2002	HSE, S, SE	<b>US9496</b>	3.0L V6 2995cc	1994-1995	Base	<b>US9306</b>
2.5L V6 2500cc 153 CID	2003	HSE, S, SE, SE3	<b>US9496</b>	3.0L V6 2995cc	1999-2003	Base	<b>US9306</b>
2.5L V6 2500cc 153 CID	2004	HSE, SE, SE3	<b>US9496</b>	<b>ES300H</b>			
2.5L V6 2500cc 153 CID	2005	SE, SE3	<b>US9496</b>	2.5L L4 2494cc 152 CID	2014-2017	Base	<b>US6211</b>
<b>LR3</b>				<b>ES330</b>			
4.0L V6 4009cc 245 CID	2005	SE	<b>US6251</b>	3.3L V6 3300cc 202 CID	2004-2006	Base	<b>US9306</b>
4.0L V6 4009cc 245 CID	2006	Base, SE	<b>US6251</b>	<b>ES350</b>			
4.0L V6 4009cc 245 CID	2007	SE	<b>US6251</b>	3.5L V6 3456cc	2007-2017	Base	<b>US6047</b>
4.4L V8 4394cc	2005-2008	HSE, SE	<b>US4124</b>	<b>GS300</b>			
4.4L V8 4394cc	2009	HSE, HSE Lux	<b>US4124</b>	3.0L L6 2997cc	1993-1997	Base	<b>US9256</b>
<b>LR4</b>				3.0L L6 2997cc	1998-2004	Base	<b>US9395</b>
3.0L V6 2995cc 183 CID	2014-2016	Base, HSE, HSE Lux	<b>US8120</b>	3.0L V6 2994cc	2006	Base	<b>US6143</b>
5.0L V8 5000cc	2010	HSE, V8	<b>US8120</b>	<b>GS350</b>			
5.0L V8 5000cc	2011	Base, HSE	<b>US8120</b>	3.5L V6 3456cc	2007-2011	Base	<b>US6143</b>
5.0L V8 5000cc	2012-2013	Base, HSE, HSE Lux	<b>US8120</b>	3.5L V6 3456cc	2013-2015	Base, F Sport	<b>US6143</b>
<b>RANGE ROVER</b>							
3.0L V6 2995cc 183 CID	2014-2017	Base, HSE	<b>US8120</b>				
3.5L V8 3532cc 216 CID	1987	Base	<b>US9368</b>				
3.5L V8 3532cc 216 CID	1988	40th Anniversary Edition, Base	<b>US9368</b>				
3.9L V8 3947cc	1989	Base, County, Hunter	<b>US9368</b>				
3.9L V8 3947cc	1990	Base, County	<b>US9368</b>				
3.9L V8 3947cc	1991	Base, County SE, Great Divide, Hunter	<b>US9368</b>				
3.9L V8 3947cc	1992	Base, County, LSE	<b>US9368</b>				
3.9L V8 3950cc	1993	County, Sport; To Engine 36D25155B	<b>US9368</b>				



Engine	Years	Application Description	USMW	Engine	Years	Application Description	USMW
<b>LEXUS (cont'd.)</b>				<b>LEXUS (cont'd.)</b>			
<b>GS350 (cont'd.)</b>				<b>RX350 (cont'd.)</b>			
3.5L V6 3456cc	2016-2017	Base, F Sport	US8150	3.5L V6 3456cc	2010	Base; Japan Built	US6047
<b>GS400</b>				3.5L V6 3456cc	2011-2012	Base	US6047
4.0L V8 3969cc	1998-2000	Base	US9257	3.5L V6 3456cc	2013-2015	Base, F Sport	US6047
<b>GS430</b>				3.5L V6 3456cc	2016-2017	Base, F Sport	US8150
4.3L V8 4293cc	2001-2007	Base	US9257	<b>RX400H</b>			
<b>GS450H</b>				3.3L V6 3300cc 202 CID	2006-2008	Base	US9306
3.5L V6 3456cc	2007-2011	Base	US6143	<b>RX450H</b>			
3.5L V6 3456cc	2013-2014	Base	US6143	3.5L V6 3456cc	2010-2015	Base	US6047
3.5L V6 3456cc	2015-2017	Base, F Sport	US6143	3.5L V6 3456cc	2016-2017	Base, F Sport	US8150
<b>GS460</b>				<b>SC300</b>			
4.6L V8 4608cc	2008-2011	Base	US6338	3.0L L6 2997cc	1992-1999	Base	US9256
<b>GS F</b>				3.0L L6 2997cc	1992-1999	With Toyota Supra twin-turbo engine	US9292
5.0L V8 4969cc 303 CID	2016-2017	Base	US6338	3.0L L6 2997cc	2000	Base	US9292
<b>GX460</b>				<b>SC400</b>			
4.6L V8 4608cc	2010-2013	Base, Premium	US6336	4.0L V8 3969cc	1992-2000	Base	US9257
4.6L V8 4608cc	2014-2017	Base, Luxury, Premium	US6336	<b>SC430</b>			
<b>GX470</b>				4.3L V8 4293cc	2002-2008	Base	US9257
4.7L V8 4663cc 285 CID	2003-2009	Base	US9257	4.3L V8 4293cc	2009	Base; From 11/2008	US9257
<b>HS250H</b>				4.3L V8 4293cc	2009	Base; To 11/2008	US9257
2.4L L4 2362cc	2010-2012	Base, Premium	US9414	4.3L V8 4293cc	2010	Base	US9257
<b>IS250</b>				<b>LINCOLN</b>			
2.5L V6 2499cc	2006-2008	Base	US6143	<b>AVIATOR</b>			
2.5L V6 2499cc	2009	Base; From 03/2009	US6143	4.6L V8 281 CID	2003-2005	Base	US8920
2.5L V6 2499cc	2009	Base; To 03/2009	US6143	<b>BLACKWOOD</b>			
2.5L V6 2499cc	2010-2013	Base, C	US6143	5.4L V8 330 CID	2002	Base	US8920
2.5L V6 2499cc	2014-2015	Base, C, C F Sport, F Sport	US6143	5.4L V8 5409cc 330 CID	2003	Mexican Application	US4128
<b>IS300</b>				<b>CONTINENTAL</b>			
3.0L L6 2997cc	2001	Base	US9395	2.4L L6 146 CID	1984-1985	Base, Givenchy, Valentino	US9154
3.0L L6 2997cc	2002-2005	Base, Sportcross	US9395	2.7L V6 164 CID	2017	Black Label, Reserve, Select; 3 Bolt Pulley	US8141
3.5L V6 3456cc	2016-2017	Base, F Sport	US6143	2.7L V6 164 CID	2017	Black Label, Reserve, Select; 3 Bolt hub Includes thermostat / housing	US8141-T
<b>IS350</b>				2.7L V6 164 CID	2017-2018	Black Label, Reserve, Select	US8141
3.5L V6 3456cc	2006-2008	Base	US6143	3.0L V6 2956cc 181 CID	2017	Black Label, Reserve; 3 Bolt Pulley	US8141
3.5L V6 3456cc	2009	Base; From 03/2009	US6143	3.0L V6 2956cc 181 CID	2017	Black Label, Reserve; 3 Bolt hub Includes thermostat / housing	US8141-T
3.5L V6 3456cc	2009	Base; To 03/2009	US6143	3.0L V6 2956cc 181 CID	2017-2018	Black Label, Reserve	US8141
3.5L V6 3456cc	2010-2013	Base, C	US6143	3.7L V6 3726cc 227 CID	2017-2018	Premiere, Select	US8910
3.5L V6 3456cc	2014-2015	Base, C, C F Sport, F Sport	US6143	3.8L V6 232 CID	1982	Base, Givenchy, Signature	US4016
3.5L V6 3456cc	2016-2017	Base, F Sport	US6143	3.8L V6 232 CID	1988-1990	Base, Signature	US4051
<b>IS F</b>				3.8L V6 232 CID	1991-1993	Base, Executive, Signature	US4051
5.0L V8 4969cc 303 CID	2008-2014	Base	US6338	3.8L V6 232 CID	1994	Base, Executive, Signature	US4089
<b>LS400</b>				4.6L V8 281 CID	1995	Diamond Anniversary, Signature, Spinnaker Edition	US4097
4.0L V8 3969cc	1990-1996	Base	US9257	4.6L V8 281 CID	1996	Anniversary, Spinnaker Edition	US4097
4.0L V8 3969cc	1997	Base; From 07/97	US9257	4.6L V8 281 CID	1997	Spinnaker Edition	US4097
4.0L V8 3969cc	1997	Base; To 07/97	US9257	4.6L V8 281 CID	1998-2002	Base	US4097
4.0L V8 3969cc	1998-2000	Base	US9257	5.0L V8 302 CID	1983-1984	Base, Givenchy, Valentino	US4014
<b>LS430</b>				5.0L V8 302 CID	1983-1984	Base, Givenchy, Valentino; High performance	US4014H
4.3L V8 4293cc	2001-2006	Base	US9257	5.0L V8 302 CID	1985	Base, Givenchy, Valentino	US4024
<b>LS460</b>				5.0L V8 302 CID	1985	Base, Givenchy, Valentino; High performance	US4024H
4.6L V8 4608cc	2007-2012	Base, L	US6338	5.0L V8 302 CID	1986-1987	Base, Givenchy	US4038
4.6L V8 4608cc	2013-2017	Base, F Sport, L	US6338	5.0L V8 302 CID	1986-1987	Base, Givenchy; High performance	US4038H
<b>LS600H</b>				5.8L V8 351 CID	1980	Base	US4014
5.0L V8 4968cc	2008-2016	L	US6338	5.8L V8 351 CID	1980	Base; High performance	US4014H
<b>LX450</b>				6.6L V8 400 CID	1977-1979	MODIFIED	US932
4.5L L6 4477cc	1996-1997	Base	US9269	7.5L V8 460 CID	1975-1978		US1114
<b>LX470</b>				<b>LS</b>			
4.7L V8 4663cc 285 CID	1998-2007	Base	US9257	3.0L V6 2968cc 181 CID	2000	Base	US4118
<b>LX570</b>				3.0L V6 2968cc 181 CID	2001-2002	Base, LSE	US4118
5.7L V8 5663cc 345 CID	2008-2011	Base	US6197	3.0L V6 2968cc 181 CID	2003	Base, LSE	US4129
5.7L V8 5663cc 345 CID	2013-2017	Base	US6197	3.0L V6 2968cc 181 CID	2004	Base	US4129
<b>RC300</b>				3.0L V6 2968cc 181 CID	2005	Appearance, Luxury, Premium	US4129
3.5L V6 3456cc	2016-2017	Base, F Sport	US6143	3.9L V8 242 CID	2000	Base	US4124
<b>RC350</b>				3.9L V8 242 CID	2001-2003	Base, LSE	US4124
3.5L V6 3456cc	2015-2017	Base, F Sport	US6143	3.9L V8 242 CID	2004	Base	US4124
<b>RC F</b>				3.9L V8 242 CID	2005	Sport, Ultimate	US4124
5.0L V8 4969cc 303 CID	2015-2017	Base	US6338	3.9L V8 242 CID	2006	Sport	US4124
<b>RX300</b>				<b>MARK IV</b>			
3.0L V6 2995cc	1999-2003	Base	US9306	7.5L V8 460 CID	1975-1976		US1114
<b>RX330</b>				<b>MARK LT</b>			
3.3L V6 3300cc 202 CID	2004-2006	Base	US9306	5.4L V8 330 CID	2006	Base	US8920
<b>RX350</b>				5.4L V8 330 CID	2007-2008	Base	US6144
3.5L V6 3456cc	2007-2009	Base	US6047	<b>MARK V</b>			
3.5L V6 3456cc	2010	Base; Exc. Japan Built	US6047	6.6L V8 400 CID	1977-1979	MODIFIED	US932
				<b>MARK VI</b>			
				5.0L V8 302 CID	1980-1981	Base	US4014

WATER PUMPS

Engine	Years	Application Description	USMW	Engine	Years	Application Description	USMW
<b>LINCOLN (cont'd.)</b>				<b>LINCOLN (cont'd.)</b>			
<b>MARK VI (cont'd.)</b>				<b>MKZ</b>			
5.0L V8 302 CID	1980-1981	Base; High performance	<b>US4014H</b>	2.0L L4 1999cc 122 CID	2013-2014	Base	<b>US4126</b>
5.0L V8 302 CID	1982	Base, Bill Blass, Givenchy, Pucci, Signature	<b>US4014</b>	2.0L L4 1999cc 122 CID	2015-2016	Base, Black Label	<b>US4126</b>
5.0L V8 302 CID	1982	Base, Bill Blass, Givenchy, Pucci, Signature; High performance	<b>US4014H</b>	2.0L L4 1999cc 122 CID	2017-2018	Black Label, Premiere, Reserve, Select	<b>US8975</b>
5.0L V8 302 CID	1983	Base, Bill Blass, Pucci, Signature	<b>US4014</b>	2.5L L4 2488cc 152 CID	2011-2012	Hybrid	<b>US4126</b>
5.0L V8 302 CID	1983	Base, Bill Blass, Pucci, Signature; High performance	<b>US4014H</b>	3.0L V6 2956cc 181 CID	2017	Black Label, Reserve, Select; 3 Bolt Pulley	<b>US8141</b>
5.8L V8 351 CID	1980	Base	<b>US4014</b>	3.0L V6 2956cc 181 CID	2017	Black Label, Reserve, Select; 3 Bolt hub Includes thermostat / housing	<b>US8141-T</b>
5.8L V8 351 CID	1980	Base; High performance	<b>US4014H</b>	3.0L V6 2956cc 181 CID	2017-2018	Black Label, Reserve, Select	<b>US8141</b>
<b>MARK VII</b>				3.5L V6 3496cc 213 CID	2007-2011	Base	<b>US6023</b>
2.4L L6 146 CID	1984-1985	Base, Bill Blass, LSC, Versace	<b>US9154</b>	3.5L V6 3496cc 213 CID	2012	Base; From 01/02/2012	<b>US8910</b>
5.0L V8 302 CID	1984	Base, Bill Blass, LSC, Versace	<b>US4014</b>	3.5L V6 3496cc 213 CID	2012	Base; To 01/02/2012	<b>US8980</b>
5.0L V8 302 CID	1984	Base, Bill Blass, LSC, Versace; High performance	<b>US4014H</b>	3.7L V6 3726cc 227 CID	2013-2014	Base	<b>US8910</b>
5.0L V8 302 CID	1985	Base, Bill Blass, Versace	<b>US4024</b>	3.7L V6 3726cc 227 CID	2015-2016	Base, Black Label	<b>US8910</b>
5.0L V8 302 CID	1985	Base, Bill Blass, Versace; High performance	<b>US4024H</b>	<b>NAVIGATOR</b>			
5.0L V8 302 CID	1985	LSC	<b>US4038</b>	3.5L V6 3496cc 213 CID	2015	Base, L	<b>US8916</b>
5.0L V8 302 CID	1985	LSC; High performance	<b>US4038H</b>	3.5L V6 3496cc 213 CID	2015	Base, L; Serpentine Belt Driven	<b>US8916</b>
5.0L V8 302 CID	1986-1987	Base, Bill Blass, LSC	<b>US4038</b>	3.5L V6 3496cc 213 CID	2016-2017	L Reserve, L Select, Reserve, Select	<b>US8916</b>
5.0L V8 302 CID	1986-1987	Base, Bill Blass, LSC; High performance	<b>US4038H</b>	5.4L V8 330 CID	1998-2005	Base	<b>US8920</b>
5.0L V8 302 CID	1988-1992	Bill Blass, LSC	<b>US4038</b>	5.4L V8 330 CID	2006	Luxury, Ultimate	<b>US8920</b>
5.0L V8 302 CID	1988-1992	Bill Blass, LSC; High performance	<b>US4038H</b>	5.4L V8 330 CID	2007	L Luxury, L Ultimate, Luxury, Ultimate	<b>US6144</b>
<b>MARK VIII</b>				5.4L V8 330 CID	2008	Base, L	<b>US6144</b>
4.6L V8 281 CID	1993-1994	Base; Pump Length: long	<b>US4113</b>	5.4L V8 330 CID	2009-2014	Base, L	<b>US8920</b>
4.6L V8 281 CID	1995	Base, LSC; Pump Length: long	<b>US4113</b>	<b>TOWN CAR</b>			
4.6L V8 281 CID	1996	Anniversary, LSC; Pump Length: long	<b>US4113</b>	4.6L V8 281 CID	1991-1992	Base, Cartier, Cypress, Executive, Signature, Touring Edition	<b>US4066</b>
4.6L V8 281 CID	1997-1998	Base, LSC; Pump Length: long	<b>US4113</b>	4.6L V8 281 CID	1993	Base, Cartier, Cypress, Executive, Jack Nicklaus, Signature, Touring Edition	<b>US4066</b>
<b>MKC</b>				4.6L V8 281 CID	1994	Base, Cartier, Cypress, Executive, Signature, Touring Edition, Tournament Edition; From 04/94	<b>US4066</b>
2.0L L4 1999cc 122 CID	2015	Base, Black Label	<b>US4126</b>	4.6L V8 281 CID	1994	Base, Cartier, Cypress, Executive, Signature, Touring Edition, Tournament Edition; To 03/94	<b>US4066</b>
2.0L L4 1999cc 122 CID	2016	Black Label, Premiere, Reserve, Select; To 09/24/2015	<b>US4126</b>	4.6L V8 281 CID	1995	Base, Cartier, Cypress, Executive, Signature, Touring Edition	<b>US4066</b>
2.0L L4 1999cc 122 CID	2016	Black Label, Premiere, Reserve, Select; From 09/24/215	<b>US8117</b>	4.6L V8 281 CID	1996	Anniversary, Base, Cartier, Executive, Signature; From 03/96	<b>US4066</b>
2.0L L4 1999cc 122 CID	2017-2018	Black Label, Premiere, Reserve, Select	<b>US8975</b>	4.6L V8 281 CID	1996	Anniversary, Base, Cartier, Executive, Signature; To 03/96	<b>US4066</b>
2.3L L4 2300cc 140 CID	2015	Base, Black Label	<b>US8117</b>	4.6L V8 281 CID	1997	Base, Cartier, Executive, Signature, Touring Edition	<b>US4066</b>
2.3L L4 2300cc 140 CID	2016-2018	Black Label, Reserve, Select	<b>US8117</b>	4.6L V8 281 CID	1998-2000	Base, Cartier, Executive, Signature; Pump Length: long	<b>US4113</b>
<b>MKS</b>				4.6L V8 281 CID	2001-2002	Base, Cartier, Cartier L, Executive, Executive L, Signature; Long Housing, Pump Length: long	<b>US4113</b>
3.5L V6 3496cc 213 CID	2010	EcoBoost	<b>US6023</b>	4.6L V8 281 CID	2001-2002	Base, Cartier, Cartier L, Executive, Executive L, Signature; Short Housing	<b>US4128</b>
3.5L V6 3496cc 213 CID	2011	EcoBoost	<b>US8910</b>	4.6L V8 281 CID	2003	Base, Executive, Executive L, Executive Protection Series, Signature; Short Housing	<b>US4128</b>
3.5L V6 3496cc 213 CID	2012	EcoBoost; From 01/02/2012	<b>US8910</b>	4.6L V8 281 CID	2003	Cartier, Cartier L	<b>US4128</b>
3.5L V6 3496cc 213 CID	2012	EcoBoost; To 01/02/2012	<b>US8910</b>	4.6L V8 281 CID	2004	Executive, Executive L, Signature, Ultimate, Ultimate L	<b>US4128</b>
3.5L V6 3496cc 213 CID	2013-2016	EcoBoost	<b>US8910</b>	4.6L V8 281 CID	2005	Executive, Executive L, Signature, Signature L, Signature Limited	<b>US4128</b>
3.7L V6 3726cc 227 CID	2009-2010	Base	<b>US6023</b>	4.6L V8 281 CID	2006-2007	Designer Series, Executive, Executive L, Signature, Signature L, Signature Limited	<b>US4128</b>
3.7L V6 3726cc 227 CID	2011	Base	<b>US8980</b>	4.6L V8 281 CID	2008-2010	Executive, Executive L, Signature L, Signature Limited	<b>US4128</b>
3.7L V6 3726cc 227 CID	2012	Base; From 01/02/2012	<b>US8910</b>	4.6L V8 281 CID	2011	Executive L, Signature L, Signature Limited	<b>US4128</b>
3.7L V6 3726cc 227 CID	2012	Base; To 01/02/2012	<b>US8980</b>	5.0L V8 302 CID	1982-1987	Base, Cartier, Signature	<b>US4014</b>
3.7L V6 3726cc 227 CID	2013-2016	Base	<b>US8910</b>	5.0L V8 302 CID	1982-1987	Base, Cartier, Signature; High performance	<b>US4014H</b>
<b>MKT</b>				5.0L V8 302 CID	1988	Base, Cartier, Signature; To 06/1988	<b>US4014</b>
2.0L L4 1999cc 122 CID	2013-2016	Base	<b>US4126</b>	5.0L V8 302 CID	1988	Base, Cartier, Signature; High performance, To 06/88	<b>US4014H</b>
3.5L V6 3496cc 213 CID	2010	EcoBoost	<b>US6023</b>	5.0L V8 302 CID	1988	Base, Cartier, Signature; From 06/1988	<b>US4052</b>
3.5L V6 3496cc 213 CID	2011	EcoBoost	<b>US8910</b>	5.0L V8 302 CID	1988	Base, Cartier, Signature; From 06/88, High performance	<b>US4052H</b>
3.5L V6 3496cc 213 CID	2012	EcoBoost; From 01/02/2012	<b>US8910</b>	5.0L V8 302 CID	1989	Base, Cartier, Signature, Signature SE	<b>US4052</b>
3.5L V6 3496cc 213 CID	2012	EcoBoost; To 01/02/2012	<b>US8910</b>	5.0L V8 302 CID	1989	Base, Cartier, Signature, Signature SE; High performance	<b>US4052H</b>
3.5L V6 3496cc 213 CID	2013-2016	EcoBoost	<b>US8910</b>	5.0L V8 302 CID	1990	Base, Cartier, Cypress, Executive, Signature, Touring Edition	<b>US4052</b>
3.5L V6 3496cc 213 CID	2017	Base	<b>US8910</b>	5.0L V8 302 CID	1990	Base, Cartier, Cypress, Executive, Signature, Touring Edition; High performance	<b>US4052H</b>
3.5L V6 3496cc 213 CID	2018	Reserve	<b>US8910</b>	<b>VERSAILLES</b>			
3.7L V6 3726cc 227 CID	2010	Base	<b>US6023</b>	5.0L V8 302 CID	1977-1979	WINDSOR	<b>US953</b>
3.7L V6 3726cc 227 CID	2011	Base	<b>US8980</b>	5.0L V8 302 CID	1977-1979	High performance	<b>US953H</b>
3.7L V6 3726cc 227 CID	2012	Base; From 01/02/2012	<b>US8910</b>	5.0L V8 302 CID	1980	Base; WINDSOR	<b>US953</b>
3.7L V6 3726cc 227 CID	2012	Base; To 01/02/2012	<b>US8980</b>	5.0L V8 302 CID	1980	Base; High performance	<b>US953H</b>
3.7L V6 3726cc 227 CID	2013-2017	Base	<b>US8910</b>	5.8L V8 351 CID	1977	WINDSOR	<b>US953</b>
3.7L V6 3726cc 227 CID	2018	Premiere	<b>US8910</b>	5.8L V8 351 CID	1977	High performance	<b>US953H</b>
<b>MKX</b>							
2.7L V6 164 CID	2016	Black Label, Premiere, Reserve, Select	<b>US8141P</b>				
2.7L V6 164 CID	2016	Black Label, Premiere, Reserve, Select; Includes 3 hole pulley	<b>US8141P</b>				
2.7L V6 164 CID	2016	Black Label, Premiere, Reserve, Select; Includes 3 hole pulley and thermostat / housing	<b>US8141P-T</b>				
2.7L V6 164 CID	2016-2017	Black Label, Premiere, Reserve, Select; 3 Bolt Pulley	<b>US8141</b>				
2.7L V6 164 CID	2016-2017	Black Label, Premiere, Reserve, Select; 3 Bolt hub Includes thermostat / housing	<b>US8141-T</b>				
2.7L V6 164 CID	2016-2018	Black Label, Premiere, Reserve, Select	<b>US8141</b>				
3.5L V6 3496cc 213 CID	2007-2010	Base	<b>US6023</b>				
3.7L V6 3726cc 227 CID	2011	Base	<b>US8980</b>				
3.7L V6 3726cc 227 CID	2012	Base; From 01/02/2012	<b>US8910</b>				
3.7L V6 3726cc 227 CID	2012	Base; To 01/02/2012	<b>US8980</b>				
3.7L V6 3726cc 227 CID	2013-2015	Base	<b>US8910</b>				
3.7L V6 3726cc 227 CID	2016-2018	Black Label, Premiere, Reserve, Select	<b>US8910</b>				

Engine	Years	Application Description	USMW	Engine	Years	Application Description	USMW
<b>LINCOLN (cont'd.)</b>				<b>MAZDA (cont'd.)</b>			
<b>ZEPHYR</b>				<b>B2000</b>			
3.0L V6 2968cc 181 CID	2006	Base	US9489	2.0L L4 1970cc	1979		US1042
3.0L V6 2968cc 181 CID	2006	Base; Includes back housing	US9489-2	2.0L L4 1970cc	1980-1981	Base, Sundowner, Sundowner Sport	US1042
<b>MAZDA</b>				2.0L L4 1970cc	1982-1983	Sundowner Base, Sundowner DLX, Sundowner Sport	US1042
<b>2</b>				2.0L L4 1970cc	1984	Sundowner Base, Sundowner SE-5, Sundowner Sport	US1042
1.5L L4 1498cc 91 CID	2011-2014	Sport, Touring	US6295	2.0L L4 1998cc 122 CID	1986-1987	Base, LX, SE-5	US9111
<b>3</b>				<b>B2200</b>			
2.0L L4 1998cc 122 CID	2012-2013	i	US6700	2.2L L4 2184cc	1987-1989	Base, LX, SE-5	US4053
2.0L L4 1998cc 122 CID	2013	i	US6219	2.2L L4 2184cc	1990-1993	Base, LE-5, SE-5	US4053
2.0L L4 1998cc 122 CID	2014	i, i Grand Touring, I Sport, I SV, I Touring	US6700	<b>B2300</b>			
2.0L L4 1998cc 122 CID	2015	i Grand Touring, I Sport, i SV, I Touring	US6700	2.3L L4 140 CID	1994	Base, SE	US4054
2.0L L4 1998cc 122 CID	2016	i Grand Touring, I Sport, I Touring	US6700	2.3L L4 140 CID	1995-1997	Base, SE	US4093
2.0L L4 1998cc 122 CID	2017	Sport, Touring	US6700	2.3L L4 140 CID	2001	SE, SX	US4126
2.0L L4 2000cc 122 CID	2004-2005	i	US4126	2.3L L4 140 CID	2002	Base	US4126
2.0L L4 2000cc 122 CID	2006-2013	i	US6219	2.3L L4 140 CID	2003-2004	Base, SE	US4126
2.3L L4 2260cc	2004	S	US4126	2.3L L4 140 CID	2005-2009	Base	US4126
2.3L L4 2260cc	2005	S, SP23	US4126	<b>B2500</b>			
2.3L L4 2260cc	2006-2009	S	US6219	2.5L L4 2492cc	1998	SE, SX	US4093
2.3L L4 2260cc	2007-2013	Mazdaspeed	US4126	2.5L L4 2492cc	1999	SE, SX, Troy Lee	US4093
2.5L L4 2488cc 152 CID	2010-2013	S	US6219	2.5L L4 2492cc	2000-2001	SE, SX	US4093
2.5L L4 2488cc 152 CID	2014-2016	s Grand Touring, s Touring	US6700	<b>B2600</b>			
2.5L L4 2488cc 152 CID	2017	Grand Touring, Touring	US6700	2.6L L4 2555cc	1987-1988	Base, LX, SE-5	US7120
<b>5</b>				2.6L L4 2606cc	1989	Base, LX, SE-5	US9167
2.3L L4 2260cc	2006	Sport, Touring	US4126	2.6L L4 2606cc	1990-1993	Base, LE-5, SE-5	US9167
2.3L L4 2260cc	2007	Grand Touring, Sport, Touring	US4126	<b>B3000</b>			
2.3L L4 2260cc	2008-2010	Grand Touring, Sport, Touring	US6219	3.0L V6 2986cc 182 CID	1994	Base, SE	US4039
2.5L L4 2488cc 152 CID	2012-2015	Grand Touring, Sport, Touring	US6219	3.0L V6 2986cc 182 CID	1995-1996	Base, SE	US4095
<b>6</b>				3.0L V6 2986cc 182 CID	1998	SE, SX	US4095
2.3L L4 2260cc	2003-2006	i	US4126	3.0L V6 2986cc 182 CID	1999	SE, Troy Lee	US4095
2.3L L4 2260cc	2006	Mazdaspeed; From 02/01/2006	US4126	3.0L V6 2986cc 182 CID	2000	SE, SX, Troy Lee	US4095
2.3L L4 2260cc	2006	Mazdaspeed; To 02/01/2006	US4126	3.0L V6 2986cc 182 CID	2001	DS, SE	US4095
2.3L L4 2260cc	2007	i, Mazdaspeed	US4126	3.0L V6 2986cc 182 CID	2002	Base, DS	US4095
2.3L L4 2260cc	2008	i	US4126	3.0L V6 2986cc 182 CID	2003-2004	DS, SE	US4095
2.5L L4 2488cc 152 CID	2009-2010	i	US4126	3.0L V6 2986cc 182 CID	2005-2007	Base, DS	US4095
2.5L L4 2488cc 152 CID	2011-2013	i	US6219	<b>B4000</b>			
2.5L L4 2488cc 152 CID	2014-2017	Grand Touring, Sport, Touring	US6700	4.0L V6 4016cc	1994-1996	LE, SE	US4060
3.0L V6 2968cc 181 CID	2003	S	US9489	4.0L V6 4016cc	1997	Base, SE	US4060
3.0L V6 2968cc 181 CID	2004	S; From 08/06/03	US9489	4.0L V6 4016cc	1998-1999	SE	US4060
3.0L V6 2968cc 181 CID	2004	S; To 08/06/2003	US9489	4.0L V6 4016cc	2000	SE, Troy Lee	US4060
3.0L V6 2968cc 181 CID	2005	S; From 07/05/2004	US9489	4.0L V6 4016cc	2001	DS, SE	US4108
3.0L V6 2968cc 181 CID	2005	S; To 07/05/2004	US9489	4.0L V6 4016cc	2002	Base, DS	US4108
3.0L V6 2968cc 181 CID	2006-2008	S	US9489	4.0L V6 4016cc	2003-2004	Base, DS, SE	US4108
3.7L V6 3726cc 227 CID	2009	S	US6023	4.0L V6 4016cc	2005-2008	Base, SE	US4108
3.7L V6 3726cc 227 CID	2010	S; To 12/14/2010	US6023	4.0L V6 4016cc	2009	Base	US4108
<b>323</b>				<b>COSMO</b>			
1.6L L4 1597cc	1986-1987	Base, DX, LX	US4049	1.3L R2 1308cc	1976-1978		US9053
1.6L L4 1597cc	1988	Base, DX, LX, SE	US4049	<b>CX-3</b>			
1.6L L4 1597cc	1988	GT, GTX	US4068	2.0L L4 1998cc 122 CID	2016-2017	Grand Touring, Sport, Touring	US6700
1.6L L4 1597cc	1989	Base, LX, SE	US4049	<b>CX-5</b>			
1.6L L4 1597cc	1989	GTX; From 10/01/1988	US4068	2.0L L4 1998cc 122 CID	2013	Grand Touring, Sport, Touring	US6700
1.6L L4 1597cc	1989	GTX; To 10/01/1988	US4068	2.0L L4 1998cc 122 CID	2014-2016	Sport	US6700
1.6L L4 1597cc	1990-1993	Base, SE	US4049	2.5L L4 2488cc 152 CID	2014	Grand Touring, Touring	US6700
1.6L L4 1597cc	1994	Base	US4049	2.5L L4 2488cc 152 CID	2015-2016	Grand Touring, Sport, Touring	US6700
<b>626</b>				2.5L L4 2488cc 152 CID	2017	Grand Select, Grand Touring, Sport, Touring	US6700
2.0L L4 1970cc	1979		US1042	<b>CX-7</b>			
2.0L L4 1970cc	1980	Base	US1042	2.3L L4 2260cc	2007-2009	Grand Touring, Sport, Touring	US4126
2.0L L4 1970cc	1981-1982	Base, LX	US1042	2.3L L4 2260cc	2010-2012	Grand Touring, Touring	US4126
2.0L L4 1970cc	1983	Base, LX	US9060	2.5L L4 2488cc 152 CID	2010	Sport, SV	US6219
2.0L L4 1991cc	1993-1998	DX, LX	US4078	2.5L L4 2488cc 152 CID	2011-2012	Sport, SV, Touring	US6219
2.0L L4 1991cc	1999-2001	ES, LX	US4078	<b>CX-9</b>			
2.0L L4 1991cc	2002	LX	US4078	3.5L V6 3496cc 213 CID	2007	Grand Touring, Sport, Touring	US6023
2.0L L4 1998cc 122 CID	1984-1985	DX, LX	US9060	3.7L V6 3726cc 227 CID	2008-2009	Grand Touring, Sport, Touring	US6023
2.0L L4 1998cc 122 CID	1984-1985	LX	US9067	3.7L V6 3726cc 227 CID	2010	Grand Touring, Sport, Touring; To 12/15/2010	US6023
2.0L L4 1998cc 122 CID	1986-1987	DX, GT, LX	US9111	<b>FAMILIA</b>			
2.2L L4 2184cc	1988	DX, LX, Turbo, Turbo 4WS	US4053	1.5L L4 1490cc 91 CID	1986	Mexican Application	US4049
2.2L L4 2184cc	1989	DX, LX, Turbo	US4053	1.6L L4 1597cc 97 CID	1986	Mexican Application	US4049
2.2L L4 2184cc	1990	DX, GT, LX	US4053	<b>GLC</b>			
2.2L L4 2184cc	1991	DX, GT, LE, LX	US4053	1.3L L4 1272cc	1977-1978		US9020
2.2L L4 2184cc	1992	DX, LX	US4053	1.4L L4 1415cc	1979		US9020
2.5L V6 2497cc	1993	ES	US9318	1.4L L4 1415cc	1980	Base, Custom, Sport	US9020
2.5L V6 2497cc	1994-2002	ES, LX	US9318	1.5L L4 1490cc	1981	Base, Sport; Early	US9050
<b>808</b>				1.5L L4 1490cc	1981	Base, Sport; Late	US9050
1.6L L4 1587cc	1977		US9300	1.5L L4 1490cc	1981	Custom, Custom L; Hatchback; Early	US9050
<b>929</b>				1.5L L4 1490cc	1981	Custom, Custom L; Hatchback; Late	US9050
3.0L V6 2954cc 180 CID	1988-1989	Base	US9166	1.5L L4 1490cc	1981-1982	Custom, Custom L; Sedan	US9050
3.0L V6 2954cc 180 CID	1990-1991	Base, S	US9166	1.5L L4 1490cc	1981-1983	Custom; Wagon	US9020
3.0L V6 2954cc 180 CID	1990-1991		US9225	<b>B1800</b>			
3.0L V6 2954cc 180 CID	1992-1995	Base	US9260	1.8L L4 1796cc	1977-1978		US1042

WATER PUMPS



Engine	Years	Application Description	USMW
<b>MAZDA (cont'd.)</b>			
<b>GLC (cont'd.)</b>			
1.5L L4 1490cc	1982	Base, Sport	US9050
1.5L L4 1490cc	1982	Custom, Custom L; Hatchback	US9050
1.5L L4 1490cc	1983	Base	US9050
1.5L L4 1490cc	1983	Custom, Custom L, Sport; Hatchback	US9050
1.5L L4 1490cc	1983	Custom, Custom L, Sport; Sedan	US9050
1.5L L4 1490cc	1984-1985	Base, DX, LX	US9050
<b>MIATA</b>			
1.6L L4 1597cc	1990	Base	US4068
1.6L L4 1597cc	1991	Base, SE	US4068
1.6L L4 1597cc	1992	Base	US4068
1.6L L4 1597cc	1993	Base, LE	US4068
1.8L L4 1839cc	1994-1996	Base, M Edition	US9305
1.8L L4 1839cc	1997	Base, M Edition, STO	US9305
1.8L L4 1839cc	1999	10th Anniversary, Base	US9305
1.8L L4 1839cc	2000-2002	Base, LS, SE	US9305
1.8L L4 1839cc	2003	Base, LS, SE, Shinsen	US9305
1.8L L4 1839cc	2004-2005	Base, LS, Mazdaspeed	US9305
<b>MILLENNIA</b>			
2.3L V6 2254cc	1995-1999	S	US9328
2.3L V6 2254cc	2000	Millennium Edition, S	US9328
2.3L V6 2254cc	2001	Base	US9328
2.3L V6 2254cc	2002	S	US9328
2.5L V6 2450cc 155 CID	2002	Base	US9318
2.5L V6 2497cc	1995-1998	Base, L	US9318
2.5L V6 2497cc	1999-2001	Base	US9318
<b>MPV</b>			
2.5L V6 2450cc 155 CID	2000-2001	DX, ES, LX	US4091
2.6L L4 2606cc	1989-1992	Cargo, Passenger	US9167
2.6L L4 2606cc	1993-1994	Passenger	US9167
3.0L V6 2954cc 180 CID	1989-1990	Passenger	US9166
3.0L V6 2954cc 180 CID	1991	Cargo, Passenger	US9166
3.0L V6 2954cc 180 CID	1992-1994	Passenger	US9166
3.0L V6 2954cc 180 CID	1995	L, LX, LXE	US9166
3.0L V6 2954cc 180 CID	1996	DX, ES, LX	US9394
3.0L V6 2954cc 180 CID	1997-1998	ES, LX	US9394
3.0L V6 2968cc 181 CID	2002	ES, LX	US4091
3.0L V6 2968cc 181 CID	2003	ES, LX; To 07/01/03	US4091
3.0L V6 2968cc 181 CID	2003	ES, LX; From 07/01/03, To 08/01/2003	US4132
3.0L V6 2968cc 181 CID	2003	ES, LX; From 08/01/2003	US4132
3.0L V6 2968cc 181 CID	2004-2005	ES, LX	US4132
3.0L V6 2968cc 181 CID	2006	ES, LX, LX-SV	US4132
<b>MX-3</b>			
1.6L L4 1597cc	1992-1993	Base	US4049
1.6L L4 1597cc	1994-1995	Base	US9305
1.8L V6 1845cc	1992	GS	US9318
1.8L V6 1845cc	1993	GS, SE	US9318
1.8L V6 1845cc	1994	GS	US9318
<b>MX-5</b>			
2.0L L4 1999cc 122 CID	2006-2008	Mexican Application	US6219
2.0L L4 1999cc 122 CID	2010-2011	Mexican Application	US6219
2.0L L4 1999cc 122 CID	2013-2014	Mexican Application	US6219
<b>MX-5 GRAND TOURING</b>			
2.0L L4 1999cc 122 CID	2010	Mexican Application	US6219
2.0L L4 1999cc 122 CID	2012	Mexican Application	US6219
<b>MX-5 MIATA</b>			
2.0L L4 2000cc 122 CID	2006	Base, Club Spec, Grand Touring, Sport, Touring	US6219
2.0L L4 2000cc 122 CID	2007-2009	Grand Touring, Sport, SV, Touring	US6219
2.0L L4 2000cc 122 CID	2010	Grand Touring, Sport, Touring	US6219
2.0L L4 2000cc 122 CID	2011-2012	Grand Touring, Special Edition, Sport, Touring	US6219
2.0L L4 2000cc 122 CID	2013-2014	Club, Grand Touring, Sport	US6219
2.0L L4 2000cc 122 CID	2015	25th Anniversary Edition, Club, Grand Touring, Sport	US6219
<b>MX-6</b>			
2.0L L4 1991cc	1993-1997	Base	US4078
2.2L L4 2184cc	1988	DX, GT, LX	US4053
2.2L L4 2184cc	1989-1990	DX, GT, GT 4WS, LX	US4053
2.2L L4 2184cc	1991	DX, GT, LE, LX	US4053
2.2L L4 2184cc	1992	DX, GT, LX	US4053
2.5L V6 2497cc	1993-1995	LS	US9318
2.5L V6 2497cc	1996	LS, M Edition	US9318
2.5L V6 2497cc	1997	LS	US9318
<b>NAVAJO</b>			
4.0L V6 4016cc	1991	LX	US4060
4.0L V6 4016cc	1992-1994	DX, LX	US4060
<b>PROTEGE</b>			
1.5L L4 1489cc	1995	DX, LX	US9305
1.5L L4 1489cc	1996-1998	DX, LX	US9371
1.6L L4 1589cc	1999-2001	DX, LX	US9305
1.8L L4 1839cc	1990	4WD, SE	US4049

Engine	Years	Application Description	USMW
<b>MAZDA (cont'd.)</b>			
<b>PROTEGE (cont'd.)</b>			
1.8L L4 1839cc	1990-1992	LX	US4068
1.8L L4 1839cc	1991	4WD, DX	US4049
1.8L L4 1839cc	1992	DX	US4049
1.8L L4 1839cc	1993	DX, LX	US4049
1.8L L4 1839cc	1994	Base, DX, LX	US4049
1.8L L4 1839cc	1995-1998	ES	US9305
1.8L L4 1839cc	1999-2000	ES	US4078
2.0L L4 2000cc	2001	ES, LX, MP3	US4078
2.0L L4 2000cc	2002	DX, ES, LX	US4078
2.0L L4 2000cc	2003	DX, ES, LX, Mazdaspeed	US4078
<b>PROTEGE5</b>			
2.0L L4 2000cc	2002-2003	Base	US4078
<b>ROTARY PICKUP</b>			
1.3L R2 1308cc	1975-1977		US9053
<b>RX-3</b>			
1.1L R2 1146cc	1975-1978		US9053
<b>RX-4</b>			
1.3L R2 1308cc	1975-1978		US9053
<b>RX-7</b>			
1.1L R2 1146cc	1979		US9053
1.1L R2 1146cc	1985	GS, GSL, S	US9053
1.3L R2 1308cc	1985	GSL-SE	US9053
1.3L R2 1308cc	1986	Base, GXL, Turbo	US9102
1.3L R2 1308cc	1987	Base, Base 2+2, GXL, GXL 2+2, LX, LX 2+2, Sport; From 12/16/1986	US9102
1.3L R2 1308cc	1987	Turbo	US9102
1.3L R2 1308cc	1988	10th Anniversary, Convertible, GTU, GXL, GXL 2+2, SE, SE 2+2, Turbo	US9102
1.3L R2 1308cc	1989-1990	Convertible, GTU, GTUs, GXL, GXL 2+2, Turbo	US9208
1.3L R2 1308cc	1991	Base, Convertible, Turbo	US9208
<b>RX-8</b>			
1.3L R2 1308cc	2004	Base	US6156
1.3L R2 1308cc	2005	Base, Shinka	US6156
1.3L R2 1308cc	2006-2007	Base	US6156
1.3L R2 1308cc	2008	40th Anniversary Edition, Grand Touring, Sport, Touring	US6156
<b>TRIBUTE</b>			
2.0L L4 1989cc 121 CID	2001-2004	DX	US4115
2.3L L4 140 CID	2005-2006	i	US4126
2.3L L4 140 CID	2008	Hybrid, i	US4126
2.5L L4 2488cc 152 CID	2009-2010	Hybrid, i	US4126
2.5L L4 2488cc 152 CID	2011	i	US4126
3.0L V6 2968cc 181 CID	2001-2002	DX, ES, LX	US4091
3.0L V6 2968cc 181 CID	2003-2004	ES, LX	US4091
3.0L V6 2968cc 181 CID	2005-2006	S	US4132
3.0L V6 2968cc 181 CID	2008	S	US4132
3.0L V6 2968cc 181 CID	2009-2011	S	US6250
<b>MERCEDES-BENZ</b>			
<b>190D</b>			
2.5L L5 2497cc	1986	2.5	US9228
2.5L L5 2497cc	1987	2.5, 2.5 Turbo	US9228
2.5L L5 2497cc	1988-1989	2.5	US9228
<b>190DT</b>			
2.5L L5 2497cc 152 CID	1990	Mexican Application	US9228
<b>190E</b>			
2.3L L4 2299cc	1984	2.3	US9173
2.3L L4 2299cc	1985	2.3	US9175
2.3L L4 2299cc	1986-1987	2.3, 2.3-16	US9175
2.3L L4 2299cc	1988	2.3	US9175
2.3L L4 2299cc	1991-1993	2.3	US9175
2.6L L6 2599cc	1987-1993	2.6	US9202
<b>220E</b>			
2.2L L4 2199cc 134 CID	1994	Mexican Application	US9314
<b>230</b>			
2.3L L4 2307cc	1975-1978		US9172
2.3L L6 2306cc 141 CID	1966-1969		US9299
<b>230E</b>			
2.3L L4 2300cc 140 CID	1986-1989	Mexican Application	US9175
2.3L L4 2300cc 140 CID	1991	Mexican Application	US9175
<b>240D</b>			
2.4L L4 2404cc	1975-1979		US9172
2.4L L4 2404cc	1980-1983	Base	US9172
<b>250</b>			
2.5L L6 2496cc 152 CID	1968-1972		US9299

Engine	Years	Application Description	USMW	Engine	Years	Application Description	USMW
<b>MERCEDES-BENZ (cont'd.)</b>				<b>MERCEDES-BENZ (cont'd.)</b>			
<b>250C</b>				<b>300TD (cont'd.)</b>			
2.8L L6 2778cc	1970-1972		US9299	3.0L L5 3005cc	1981-1982	Base	US9172
<b>250D</b>				3.0L L6 2998cc	1987	Base	US9228
2.5L L5 2497cc 152 CID	1986	Mexican Application	US9228	<b>300TE</b>			
<b>260E</b>				3.0L L6 2962cc	1988-1989	Base	US9202
2.6L L6 2599cc	1987-1989	Base	US9202	3.0L L6 2962cc	1990-1992	4Matic, Base	US9202
2.6L L6 2599cc 158 CID	1992	Mexican Application	US9202	3.0L L6 2962cc	1993	4Matic	US9202
<b>260SE</b>				3.0L L6 2962cc 180 CID	1986-1987	Mexican Application	US9202
2.6L L6 2599cc 158 CID	1987	Mexican Application	US9202	3.2L L6 3199cc	1993	Base; To Engine 072236	US9313
2.6L L6 2599cc 158 CID	1989	Mexican Application	US9202	3.2L L6 3199cc	1993	Base; From Engine 072237	US9345
<b>280</b>				<b>350SD</b>			
2.8L L6 2746cc	1973-1976		US9299	3.4L L6 3449cc	1991	Base	US9228
<b>280C</b>				<b>350SDL</b>			
2.8L L6 2746cc	1973-1976		US9299	3.4L L6 3449cc	1990-1991	Base	US9228
<b>280CE</b>				<b>380SE</b>			
2.8L L6 2746cc	1978-1980		US9299	3.8L V8 3839cc	1984-1985	Base	US9230
<b>280E</b>				<b>380SEC</b>			
2.8L L6 2746cc	1978-1980		US9299	3.8L V8 3839cc	1982-1983	Base	US9230
2.8L L6 2799cc 171 CID	1993	Mexican Application	US9345	<b>380SEL</b>			
<b>280S</b>				3.8L V8 3839cc	1981-1983	Base	US9230
2.8L L6 2746cc	1975-1976		US9299	<b>380SL</b>			
2.8L L6 2778cc	1969-1971		US9299	3.8L V8 3839cc	1981-1985	Base	US9230
<b>280SE</b>				<b>380SLC</b>			
2.8L L6 2746cc	1977-1980		US9299	3.8L V8 3839cc	1981	Base	US9230
2.8L L6 2778cc	1969-1972		US9299	<b>400E</b>			
<b>280SEL</b>				4.2L V8 4196cc	1992-1993	Base; To Engine 020771	US9315
2.8L L6 2778cc	1969-1971		US9299	4.2L V8 4196cc	1992-1993	Base; From Engine 020772	US9346
<b>280SL</b>				4.2L V8 4196cc 256 CID	1994	Mexican Application	US9346
2.8L L6 2778cc	1969-1971		US9299	<b>400SE</b>			
<b>300CD</b>				4.2L V8 4196cc	1992	Base; To Engine 026750	US9315
3.0L L5 2998cc	1983-1985	Base	US9172	4.2L V8 4196cc	1992	Base; From Engine 026751	US9346
3.0L L5 3005cc	1978-1979		US9172	4.2L V8 4196cc 256 CID	1996-1997	Mexican Application	US9346
3.0L L5 3005cc	1980-1981	Base; Early	US9172	<b>400SEL</b>			
3.0L L5 3005cc	1980-1981	Base; Late	US9172	4.2L V8 4196cc	1993	Base; To Engine 026750	US9315
3.0L L5 3005cc	1982	Base	US9172	4.2L V8 4196cc	1993	Base; From Engine 026751	US9346
<b>300CE</b>				4.2L V8 4196cc 256 CID	1995	Mexican Application	US9346
3.0L L6 2962cc	1988-1989	Base	US9202	4.2L V8 4196cc 256 CID	1997	Mexican Application	US9346
3.0L L6 2962cc	1990-1992	Base	US9222	<b>420SE</b>			
3.0L L6 2962cc 180 CID	1993	Mexican Application	US9202	4.2L V8 4196cc 256 CID	1986	Mexican Application	US9231
3.2L L6 3199cc	1993	Base; To Engine 072236	US9313	<b>420SEL</b>			
3.2L L6 3199cc	1993	Base; From Engine 072237	US9345	4.2L V8 4196cc	1986-1991	Base	US9231
<b>300D</b>				<b>420SL</b>			
2.5L L5 2497cc	1990-1993	2.5	US9228	4.2L V8 4196cc 256 CID	1986	Mexican Application	US9231
3.0L L5 2998cc	1983-1985	Base	US9172	4.2L V8 4196cc 256 CID	1996-1997	Mexican Application	US9346
3.0L L5 2998cc 182 CID	1986	Mexican Application	US9228	<b>450SE</b>			
3.0L L5 3005cc	1975-1979		US9172	4.5L V8 4520cc	1975-1976		US9176
3.0L L5 3005cc	1980-1982	Base	US9172	<b>450SEL</b>			
3.0L L6 2985cc 182 CID	1989	Mexican Application	US9172	4.5L V8 4520cc	1975-1979		US9176
3.0L L6 2998cc	1987	Base	US9228	4.5L V8 4520cc	1980	Base	US9176
<b>300E</b>				<b>450SL</b>			
2.6L L6 2599cc	1990-1992	2.6	US9202	4.5L V8 4520cc	1975-1979		US9176
2.8L L6 2799cc	1993	2.8	US9313	4.5L V8 4520cc	1980	Base	US9176
3.0L L6 2962cc	1986-1989	Base	US9202	<b>450SLC</b>			
3.0L L6 2962cc	1990-1992	4Matic, Base	US9202	4.5L V8 4520cc	1975-1979		US9176
3.0L L6 2962cc	1993	4Matic	US9202	4.5L V8 4520cc	1980	Base	US9176
3.2L L6 3199cc	1993	Base; To Engine 072236	US9313	<b>500CL</b>			
3.2L L6 3199cc	1993	Base; From Engine 072237	US9345	5.0L V8 4973cc 303 CID	1996-1997	Mexican Application	US9346
<b>300SD</b>				<b>500E</b>			
3.0L L5 2998cc	1983-1985	Base	US9172	5.0L V8 4973cc	1992-1993	Base; To Engine 010204	US9315
3.0L L5 3005cc	1978-1979		US9172	5.0L V8 4973cc	1992-1993	Base; From Engine 010205	US9346
3.0L L5 3005cc	1980-1982	Base	US9172	5.0L V8 4973cc 303 CID	1991	Mexican Application	US9315
3.4L L6 3449cc	1992-1993	Base	US9228	<b>500SE</b>			
<b>300SDL</b>				5.0L V8 4973cc 303 CID	1986	Mexican Application	US9230
3.0L L6 2998cc	1986-1987	Base	US9228	<b>500SEC</b>			
<b>300SE</b>				5.0L V8 4973cc	1984-1985	Base	US9230
3.0L L6 2962cc	1988-1991	Base	US9202	5.0L V8 4973cc	1993	Base; To Engine 056885	US9315
3.2L L6 3199cc	1992-1993	Base	US9343	5.0L V8 4973cc	1993	Base; From Engine 056886	US9346
<b>300SEL</b>				5.0L V8 4973cc 303 CID	1987	Mexican Application	US9230
2.8L L6 2778cc	1968-1969		US9299	5.0L V8 4973cc 303 CID	1996-1997	Mexican Application	US9346
3.0L L6 2962cc	1988-1991	Base	US9202	<b>500SEL</b>			
<b>300SL</b>				5.0L V8 4973cc	1984-1985	Base	US9230
3.0L L6 2962cc	1990-1993	Base	US9222	5.0L V8 4973cc	1992-1993	Base; To Engine 056885	US9315
3.0L L6 2962cc 180 CID	1986	Mexican Application	US9202	5.0L V8 4973cc	1992-1993	Base; From Engine 056886	US9346
<b>300TD</b>				<b>WATER PUMPS</b>			
3.0L L5 2998cc	1983-1985	Base	US9172				

Engine	Years	Application Description	USMW	Engine	Years	Application Description	USMW
<b>MERCEDES-BENZ (cont'd.)</b>				<b>MERCEDES-BENZ (cont'd.)</b>			
<b>500SEL (cont'd.)</b>				<b>C320</b>			
5.0L V8 4973cc 303 CID	1991	Mexican Application	US9315	3.2L V6 3199cc	2001-2002	Base	US9379
5.0L V8 4973cc 303 CID	1994	Mexican Application	US9315	3.2L V6 3199cc	2003-2005	4Matic, Base	US9379
5.0L V8 4973cc 303 CID	1995-1997	Mexican Application	US9346	<b>C350</b>			
<b>500SL</b>				3.5L V6 3498cc	2006	4Matic, Luxury, Sport; To 03/02/2005	US6075
5.0L V8 4973cc	1990-1992	Base	US9315	3.5L V6 3498cc	2006	4Matic, Luxury, Sport; From 03/02/2005	US6142
5.0L V8 4973cc	1993	Base; To Engine 013777	US9315	3.5L V6 3498cc	2006-2007	4Matic, Luxury, Sport; Engine Cooling	US11015
5.0L V8 4973cc	1993	Base; From Engine 013778	US9346	3.5L V6 3498cc	2007	4Matic, Luxury, Sport	US6142
5.0L V8 4973cc 303 CID	1986	Mexican Application	US9230	3.5L V6 3498cc	2008-2011	Sport	US6142
5.0L V8 4973cc 303 CID	1989	Mexican Application	US9315	<b>CL55 AMG</b>			
<b>560SE</b>				5.5L V8 5439cc 335 CID	2001-2002	Base	US9380
5.6L V8 5547cc 338 CID	1986	Mexican Application	US9231	<b>CL63 AMG</b>			
<b>560SEC</b>				6.3L V8 6208cc	2008-2010	Engine Cooling	US11015
5.6L V8 5547cc	1986-1991	Base	US9231	<b>CL65 AMG</b>			
<b>560SEL</b>				6.0L V12 5980cc 365 CID	2005-2006		US6273
5.6L V8 5547cc	1986-1991	Base	US9231	6.0L V12 5980cc 365 CID	2005-2006	Turbocharged; Engine Cooling	US11015
5.6L V8 5547cc 338 CID	1994	Mexican Application	US9231	6.0L V12 5980cc 365 CID	2008-2013		US6273
5.6L V8 5547cc 338 CID	1996	Mexican Application	US9231	6.0L V12 5980cc 365 CID	2008-2014	Turbocharged; Engine Cooling	US11015
<b>560SL</b>				6.0L V12 5980cc 365 CID	2014	Base	US6273
5.6L V8 5547cc	1986-1989	Base	US9231	<b>CL500</b>			
<b>600CL</b>				5.0L V8 4966cc	2006	Base	US9379
6.0L V12 5987cc 365 CID	1996-1997	Mexican Application	US9277	5.0L V8 4973cc	1998-1999	Base	US9346
<b>600SEC</b>				5.0L V8 4973cc	2000-2005	Base	US9379
6.0L V12 5987cc	1993	Base	US9277	5.5L V8 5461cc 333 CID	2008-2010	Mexican Application	US9380
6.0L V12 5987cc 365 CID	1994-1997	Mexican Application	US9277	<b>CL550</b>			
<b>600SEL</b>				4.6L V8 4663cc	2011-2014	4Matic; Turbocharged; Engine Cooling	US11015
6.0L V12 5987cc	1992-1993	Base	US9277	5.5L V8 5461cc	2007-2008	Base	US6235
6.0L V12 5987cc 365 CID	1991	Mexican Application	US9277	5.5L V8 5461cc	2009-2010	4Matic	US6235
6.0L V12 5987cc 365 CID	1994-1997	Mexican Application	US9277	<b>CL600</b>			
<b>600SL</b>				5.5L V12 5513cc 336 CID	2003-2014	Base	US6273
6.0L V12 5987cc	1993	Base	US9277	5.5L V12 5513cc 336 CID	2003-2014	Turbocharged; Engine Cooling	US11015
<b>A160</b>				5.8L V12 5786cc	2001-2002		US6273
1.6L L4 1587cc 97 CID	2000-2001	Mexican Application	US8985	5.8L V12 5786cc 353 CID	2003	Mexican Application	US9277
1.6L L4 1598cc 98 CID	2002-2005	Mexican Application	US8985	6.0L V12 5987cc	1998-1999	Base	US9277
<b>C32 AMG</b>				<b>CLK55 AMG</b>			
3.2L V6 3199cc	2002-2004	Supercharged; Engine Cooling	US11015	5.5L V8 5439cc 335 CID	2001-2006	Base	US9380
<b>C36 AMG</b>				<b>CLK320</b>			
3.6L L6 3606cc	1995	Base	US9345	3.2L V6 3199cc	1998-2002	Base; From Engine 30 033141	US9379
3.6L L6 3606cc	1996-1997	Base	US9311	3.2L V6 3199cc	1998-2002	Base; To Engine 30 033140	US9380
<b>C43 AMG</b>				3.2L V6 3199cc	2003-2005	Base	US9379
4.3L V8 4266cc	1998-2000	Base	US9379	<b>CLK350</b>			
<b>C55 AMG</b>				3.5L V6 3498cc	2006	Base; To 03/02/2005	US6075
5.5L V8 5439cc 332 CID	2007	Mexican Application	US9380	3.5L V6 3498cc	2006	Base; From 03/02/2005	US6142
5.5L V8 5439cc 335 CID	2005-2006	Base	US9380	3.5L V6 3498cc	2007-2009	Base	US6142
<b>C220</b>				<b>CLK430</b>			
2.2L L4 2199cc	1994-1996	Base	US9314	4.3L V8 4266cc	1999-2003	Base	US9379
<b>C230</b>				<b>CLK500</b>			
1.8L L4 1796cc	2003-2005	Kompressor	US6030	5.0L V8 4966cc	2006	Base	US9379
2.3L L4 2295cc	1997-1998	Base	US9314	5.0L V8 4966cc 303 CID	2007-2009	Mexican Application	US9379
2.3L L4 2295cc	1999-2000	Kompressor	US9440	5.0L V8 4973cc	2003-2005	Base	US9379
2.3L L4 2295cc	2002	Kompressor	US6229	<b>CLK550</b>			
2.5L V6 2496cc	2006	Sport; To 03/02/2005	US6075	5.5L V8 5461cc	2007-2009	Base	US6235
2.5L V6 2496cc	2006	Sport; From 03/02/2005	US6142	<b>CLS55 AMG</b>			
2.5L V6 2496cc	2007	Sport	US6142	5.5L V8 5439cc 335 CID	2006	Electric Water Pump, HVAC System	US11009
<b>C240</b>				5.5L V8 5439cc 335 CID	2006	Supercharged; Engine Cooling	US11015
2.6L V6 2597cc	2001-2002	Base	US9379	<b>CLS63 AMG</b>			
2.6L V6 2597cc	2003-2005	4Matic, Base	US9379	5.5L V8 5461cc	2012-2013	Base; Turbocharged; Engine Cooling	US11015
<b>C280</b>				5.5L V8 5461cc	2014	4Matic; Turbocharged; Engine Cooling	US11015
2.8L L6 2799cc	1994	Base	US9313	6.3L V8 6208cc	2007-2011	Electric Water Pump	US11009
2.8L L6 2799cc	1995	Base; To Engine 034966	US9313	<b>CLS500</b>			
2.8L L6 2799cc	1995	Base; From Engine 034967	US9345	5.0L V8 4966cc	2006	Base	US9379
2.8L L6 2799cc	1996-1997	Base	US9344	5.0L V8 4966cc	2006	Electric Water Pump	US11009
2.8L V6 2799cc	1998-2000	Base	US9379	5.0L V8 4966cc 303 CID	2007	Mexican Application	US9379
3.0L V6 2996cc	2006	4Matic, Luxury; To 03/02/2005	US6075	5.5L V8 5461cc 333 CID	2008-2011	Mexican Application	US9380
3.0L V6 2996cc	2006	4Matic, Luxury; From 03/02/2005	US6142	<b>CLS550</b>			
3.0L V6 2996cc	2006-2007	4Matic, Luxury; Engine Cooling	US11015	4.6L V8 4663cc	2012-2014	4Matic, Base; Turbocharged; Engine Cooling	US11015
3.0L V6 2996cc	2007	4Matic, Luxury	US6142	5.5L V8 5461cc	2007-2011	Base	US6235
<b>C300</b>				5.5L V8 5461cc	2007-2011	Electric Water Pump	US11009
3.0L V6 2996cc	2008-2011	4Matic Luxury, 4Matic Sport, Luxury, Sport	US6142				
3.0L V6 2996cc	2012	4Matic Luxury, 4Matic Sport	US6142				



Engine	Years	Application Description	USMW	Engine	Years	Application Description	USMW
<b>MERCEDES-BENZ (cont'd.)</b>				<b>MERCEDES-BENZ (cont'd.)</b>			
<b>E55 AMG</b>				<b>G500L</b>			
5.5L V8 5439cc 335 CID	1999-2002	Base	US9380	5.0L V8 4973cc 303 CID	2000	Mexican Application	US9379
5.5L V8 5439cc 335 CID	2003-2006	Electric Water Pump, HVAC System	US11009	5.0L V8 4973cc 303 CID	2001	Mexican Application	US9380
5.5L V8 5439cc 335 CID	2003-2006	Supercharged; Engine Cooling	US11015	<b>G550</b>			
<b>E63 AMG</b>				5.5L V8 5461cc	2009-2015	Base	US6235
5.5L V8 5461cc	2012-2013	Base; Turbocharged; Engine Cooling	US11015	5.5L V8 5461cc	2009-2015	Base; Electric Water Pump, Optional	US11024
5.5L V8 5461cc	2014	4Matic; Turbocharged; Engine Cooling	US11015	<b>GL63 AMG</b>			
6.3L V8 6208cc	2007-2009	Electric Water Pump	US11009	5.5L V8 5461cc 333 CID	2013-2014	Base; Turbocharged	US11015
<b>E63 AMG S</b>				<b>GL320</b>			
5.5L V8 5461cc	2014	4Matic; Turbocharged; Engine Cooling	US11015	3.0L V6 2987cc	2007-2008	CDI	US6155
<b>E280</b>				3.0L V6 2987cc	2007-2008	CDI; Electric Water Pump	US11009
2.8L L6 2800cc 171 CID	1999	Mexican Application	US9344	3.0L V6 2987cc	2009	Bluetec 4Matic	US6155
3.0L V6 2996cc 183 CID	2007	Mexican Application	US6142	3.0L V6 2987cc	2009	Bluetec 4Matic; Electric Water Pump	US11009
<b>E300</b>				<b>GL350</b>			
3.0L L6 2996cc	1995-1999	Base	US9228		2010-2012	Bluetec 4Matic; Electric Water Pump	US11009
<b>E320</b>				3.0L V6 2987cc	2010-2013	Bluetec 4Matic	US6155
3.0L V6 2987cc	2007-2009	Bluetec	US6155	<b>GL450</b>			
3.0L V6 2987cc	2007-2009	Bluetec; Electric Water Pump	US11009	4.6L V8 4663cc	2007-2012	Base	US6235
3.2L L6 3199cc	1994-1995	Base; To Engine 072236	US9313	4.6L V8 4663cc	2007-2012		US11009
3.2L L6 3199cc	1994-1995	Base; From Engine 072237	US9345	4.6L V8 4663cc	2013-2014	Base; Turbocharged	US11015
3.2L L6 3199cc	1996-1997	Base	US9344	<b>GL500</b>			
3.2L L6 3222cc	2005-2006	CDI	US6152	5.5L V8 5461cc 333 CID	2008-2011	Mexican Application	US9380
3.2L L6 3222cc	2005-2006	CDI; Electric Water Pump	US11009	<b>GL550</b>			
3.2L V6 3199cc	1998-2003	4Matic, Base; Exc.Oil Cooler Fitting	US9379	4.6L V8 4663cc	2013-2014	4Matic; Turbocharged	US11015
3.2L V6 3199cc	1998-2003	4Matic, Base; Oil Cooler Fitting	US9380	5.5L V8 5461cc	2008-2012	Base	US6235
3.2L V6 3199cc	2003	Base; Electric Water Pump	US11009	5.5L V8 5461cc	2008-2012		US11009
3.2L V6 3199cc	2004-2005	4Matic	US9379	<b>GLK350</b>			
3.2L V6 3199cc	2004-2005	Base; Exc.Oil Cooler Fitting	US9379	3.5L V6 3498cc	2010-2012	4Matic, Base	US6142
3.2L V6 3199cc	2004-2005	Base; Oil Cooler Fitting	US9380	<b>MAYBACH S600</b>			
3.2L V6 3199cc	2004-2005	4Matic, Base; Electric Water Pump	US11009	6.0L V12 5980cc 365 CID	2016-2017	Base	US6273
<b>E350</b>				<b>ML55 AMG</b>			
3.0L V6 2987cc	2011-2013	Bluetec	US6155	5.5L V8 5439cc 335 CID	2000-2003	Base	US9380
3.5L V6 3498cc	2006	4Matic, Base; To 03/02/2005	US6075	<b>ML63 AMG</b>			
3.5L V6 3498cc	2006	4Matic, Base; From 03/02/2005	US6142	5.5L V8 5461cc	2012	Charge Air Cooling, Electric Water Pump, To 12/02/2011	US11009
3.5L V6 3498cc	2006-2009	4Matic, Base; Electric Water Pump	US11009	5.5L V8 5461cc	2012-2014	Base; Turbocharged	US11015
3.5L V6 3498cc	2007-2011	4Matic, Base	US6142	6.3L V8 6208cc	2007-2011	Electric Water Pump, HVAC System	US11009
<b>E420</b>				6.3L V8 6208cc	2007-2011	Base; Naturally Aspirated	US11015
4.2L V8 4196cc	1994-1995	Base; To Engine 020771	US9315	<b>ML320</b>			
4.2L V8 4196cc	1994-1995	Base; From Engine 020772	US9346	3.0L V6 2987cc	2007-2008	CDI	US6155
4.2L V8 4196cc	1997	Base	US9346	3.0L V6 2987cc	2007-2008	CDI; Electric Water Pump	US11009
<b>E430</b>				3.0L V6 2987cc	2009	Bluetec 4Matic	US6155
4.3L V8 4266cc	1998-1999	Base	US9379	3.0L V6 2987cc	2009	Bluetec 4Matic; Electric Water Pump	US11009
4.3L V8 4266cc	2000-2002	4Matic, Base	US9379	3.2L V6 3199cc	1998-2003	Base	US9379
<b>E500</b>				<b>ML350</b>			
5.0L V8 4966cc	2004-2005	4Matic	US9379	3.0L V6 2987cc	2010-2011	Bluetec 4Matic; Electric Water Pump	US11009
5.0L V8 4966cc	2004-2005	4Matic; Electric Water Pump	US11009	3.0L V6 2987cc	2010-2013	Bluetec 4Matic	US6155
5.0L V8 4966cc	2006	4Matic, Base	US9379	3.5L V6 3498cc	2006	4Matic; To 03/02/2005	US6075
5.0L V8 4966cc	2006	4Matic, Base; Electric Water Pump	US11009	3.5L V6 3498cc	2006	4Matic; From 03/02/2005	US6142
5.0L V8 4973cc	1994	Base; To Engine 010204	US9315	3.5L V6 3498cc	2006-2008	4Matic; Electric Water Pump	US11009
5.0L V8 4973cc	1994	Base; From Engine 010205	US9346	3.5L V6 3498cc	2007-2008	4Matic	US6142
5.0L V8 4973cc	2003-2005	Base	US9379	3.5L V6 3498cc	2009-2011	4Matic, Base	US6142
5.0L V8 4973cc	2003-2005	Base; Electric Water Pump	US11009	3.5L V6 3498cc	2009-2011	4Matic, Base; Electric Water Pump	US11009
5.5L V8 5461cc 333 CID	2008-2011	Mexican Application	US9380	3.7L V6 3699cc	2003-2005	Base	US9379
<b>E550</b>				<b>ML430</b>			
4.6L V8 4663cc	2012-2014	4Matic, Base; Turbocharged; Engine Cooling	US11015	4.3L V8 4266cc	1999-2001	Base	US9380
5.5L V8 5461cc	2007-2009	4Matic, Base; Electric Water Pump	US11009	<b>ML450</b>			
5.5L V8 5461cc	2007-2011	4Matic, Base	US6235	3.5L V6 3498cc	2010-2011	Hybrid 4Matic; Electric Water Pump, Engine Cooling	US11009
<b>G55 AMG</b>				3.5L V6 3498cc	2010-2011	Hybrid 4Matic; ELECTRIC/GAS; Inverter Cooling	US11015
5.5L V8 5439cc 335 CID	2003-2004	Base	US9380	<b>ML500</b>			
5.5L V8 5439cc 335 CID	2003-2004	Base; Electric Water Pump, Optional	US11024	5.0L V8 4966cc	2002	Base	US9380
5.5L V8 5439cc 335 CID	2005-2011	Supercharged; Charge Air Cooling	US11015	5.0L V8 4966cc	2006	Base	US9380
5.5L V8 5439cc 335 CID	2005-2011	Base; Electric Water Pump, Engine Cooling(Optional)	US11024	5.0L V8 4966cc	2006	Base; Electric Water Pump	US11009
<b>G63 AMG</b>				5.0L V8 4966cc 303 CID	2003-2005	Base	US9380
5.5L V8 5461cc	2013-2014	Electric Water Pump, HVAC System	US11009	5.0L V8 4966cc 303 CID	2007	Base	US9380
<b>G65 AMG</b>				5.0L V8 4973cc	2007	Base; Electric Water Pump	US11009
6.0L V12 5980cc 365 CID	2016-2017	Base	US6273	<b>ML550</b>			
<b>G500</b>				4.6L V8 4663cc	2014	Base; Turbocharged	US11015
5.0L V8 4966cc	2002-2004	Base; Exc.Oil Cooler Fitting	US9379	5.5L V8 5461cc	2008-2011	Base	US6235
5.0L V8 4966cc	2002-2004	Base; Oil Cooler Fitting	US9380	5.5L V8 5461cc	2008-2011	Base; Electric Water Pump	US11009
5.0L V8 4966cc	2002-2004	Base; Electric Water Pump, Optional	US11024	<b>R63 AMG</b>			
5.0L V8 4966cc	2006-2008	Base; Exc.Oil Cooler Fitting	US9379	6.3L V8 6208cc	2007	Base; Electric Water Pump, HVAC System (Auxiliary Heater)	US11009
5.0L V8 4966cc	2006-2008	Base; Oil Cooler Fitting	US9380	6.3L V8 6208cc	2007	Naturally Aspirated	US11015
5.0L V8 4966cc	2006-2008	Base; Electric Water Pump, Optional	US11024				
5.0L V8 4973cc	2005	Base; Exc.Oil Cooler Fitting	US9379				
5.0L V8 4973cc	2005	Base; Oil Cooler Fitting	US9380				
5.0L V8 4973cc	2005	Base; Electric Water Pump, Optional	US11024				

WATER PUMPS

Engine	Years	Application Description	USMW	Engine	Years	Application Description	USMW
<b>MERCEDES-BENZ (cont'd.)</b>				<b>MERCEDES-BENZ (cont'd.)</b>			
<b>R320</b>				<b>SL65 AMG</b>			
3.0L V6 2987cc	2007-2008	CDI	<b>US6155</b>	6.0L V12 5980cc 365 CID	2005-2008	Base	<b>US6273</b>
3.0L V6 2987cc	2007-2008	CDI; Electric Water Pump, HVAC System (Auxiliary Heater)	<b>US11009</b>	6.0L V12 5980cc 365 CID	2005-2008	Base; Turbocharged; Engine Cooling	<b>US11015</b>
3.0L V6 2987cc	2009	Bluetec	<b>US6349</b>	6.0L V12 5980cc 365 CID	2009	Base, Black Series	<b>US6273</b>
3.0L V6 2987cc	2009	Bluetec; Electric Water Pump, HVAC System (Auxiliary Heater)	<b>US11009</b>	6.0L V12 5980cc 365 CID	2009	Base, Black Series; Turbocharged; Engine Cooling	<b>US11015</b>
<b>R350</b>				<b>SL320</b>			
3.0L V6 2987cc	2010-2012	Bluetec 4Matic	<b>US6155</b>	3.2L L6 3199cc	1994-1996	Base; To Engine 009985	<b>US9313</b>
3.0L V6 2987cc	2010-2012	Bluetec 4Matic; Electric Water Pump, HVAC System (Auxiliary Heater)	<b>US11009</b>	3.2L L6 3199cc	1994-1996	Base; From Engine 009986	<b>US9345</b>
3.5L V6 3498cc	2006	4Matic; To 03/02/2005	<b>US6075</b>	3.2L L6 3199cc	1997	Base	<b>US9344</b>
3.5L V6 3498cc	2006	4Matic; From 03/02/2005	<b>US6142</b>	<b>SL500</b>			
3.5L V6 3498cc	2006-2007	4Matic; Electric Water Pump, HVAC System (Auxiliary Heater)	<b>US11009</b>	5.0L V8 4966cc	2006	Base	<b>US9379</b>
3.5L V6 3498cc	2007	4Matic	<b>US6142</b>	5.0L V8 4973cc	1994-1996	Base; To Engine 013777	<b>US9315</b>
3.5L V6 3498cc	2008-2009	4Matic, Base	<b>US6142</b>	5.0L V8 4973cc	1994-1996	Base; From Engine 013778	<b>US9346</b>
3.5L V6 3498cc	2008-2009	4Matic, Base; Electric Water Pump, HVAC System (Auxiliary Heater)	<b>US11009</b>	5.0L V8 4973cc	1997-1999	Base	<b>US9346</b>
3.5L V6 3498cc	2010-2011	4Matic	<b>US6142</b>	5.0L V8 4973cc	2000-2005	Base	<b>US9379</b>
3.5L V6 3498cc	2010-2012	4Matic; Electric Water Pump, HVAC System (Auxiliary Heater)	<b>US11009</b>	5.5L V8 5461cc 333 CID	2008-2011	Mexican Application	<b>US9380</b>
<b>R500</b>				<b>SL550</b>			
5.0L V8 4966cc	2006	Base	<b>US9379</b>	4.6L V8 4663cc	2013-2014	Base; Turbocharged	<b>US11015</b>
5.0L V8 4966cc	2006	Base; Electric Water Pump, HVAC System (Auxiliary Heater)	<b>US11009</b>	5.5L V8 5461cc	2007-2009	Base	<b>US6235</b>
5.0L V8 4973cc	2007	Base	<b>US9379</b>	5.5L V8 5461cc	2011-2012	Base	<b>US6235</b>
5.0L V8 4973cc	2007	Base; Electric Water Pump, HVAC System (Auxiliary Heater)	<b>US11009</b>	<b>SL600</b>			
<b>S55 AMG</b>				<b>SL630</b>			
5.5L V8 5439cc 335 CID	2001-2002	Base	<b>US9380</b>	5.5L V12 5513cc 336 CID	2004-2009	Base	<b>US6273</b>
<b>S63 AMG</b>				<b>SL65 AMG</b>			
5.5L V8 5461cc	2011-2013	Base; Turbocharged	<b>US11015</b>	5.5L V12 5513cc 336 CID	2004-2009	Base; Turbocharged; Engine Cooling	<b>US11015</b>
<b>S65 AMG</b>				<b>SLK32 AMG</b>			
6.0L V12 5980cc 365 CID	2006	Base; Turbocharged; Engine Cooling	<b>US11015</b>	3.2L V6 3199cc	2002-2004	Base; Supercharged	<b>US11015</b>
6.0L V12 5980cc 365 CID	2006-2013	Base	<b>US6273</b>	3.2L V6 3199cc	2002-2004	Base; Electric Water Pump, Heated Windshield Washer System	<b>US11024</b>
6.0L V12 5980cc 365 CID	2015-2017	Base	<b>US6273</b>	<b>SLK230</b>			
<b>S320</b>				<b>SLK230</b>			
3.2L L6 3199cc	1994-1996	LWB, SWB; From Engine 031210	<b>US9343</b>	2.3L L4 2295cc	1998-2004	Kompressor	<b>US6229</b>
3.2L L6 3199cc	1994-1996	LWB, SWB; To Engine 031209	<b>US9343</b>	2.3L L4 2295cc	2000	Kompressor; Electric Water Pump, HVAC System(Optional)	<b>US11024</b>
3.2L L6 3199cc	1997-1999	LWB, SWB	<b>US9351</b>	2.3L L4 2295cc	2001-2004	Kompressor; Electric Water Pump, HVAC System	<b>US11024</b>
<b>S350</b>				<b>SLK280</b>			
3.0L V6 2987cc	2012-2013	Bluetec 4Matic	<b>US6155</b>	3.0L V6 2996cc	2006	Base; To 03/02/2005	<b>US6075</b>
3.4L L6 3449cc	1994-1995	Base	<b>US9228</b>	3.0L V6 2996cc	2006	Base; From 03/02/2005	<b>US6142</b>
3.7L V6 3724cc	2006	Base	<b>US9379</b>	3.0L V6 2996cc	2007-2008	Base	<b>US6142</b>
<b>S420</b>				<b>SLK300</b>			
4.2L V8 4196cc	1994-1995	Base; To Engine 026750	<b>US9315</b>	3.0L V6 2996cc	2009-2011	Base	<b>US6142</b>
4.2L V8 4196cc	1994-1995	Base; From Engine 026751	<b>US9346</b>	<b>SLK320</b>			
4.2L V8 4196cc	1996-1999	Base	<b>US9346</b>	3.2L V6 3199cc	2001-2003	Base; From Chassis/VIN 30 033141	<b>US9379</b>
<b>S430</b>				<b>SLK320</b>			
4.3L V8 4266cc	2000-2002	Base	<b>US9379</b>	3.2L V6 3199cc	2001-2003	Base; To Chassis/VIN 30 033140	<b>US9380</b>
4.3L V8 4266cc	2003-2006	4Matic, Base	<b>US9379</b>	3.2L V6 3199cc	2001-2004	Base; Electric Water Pump	<b>US11024</b>
4.3L V8 4266cc 260 CID	1998-1999	Mexican Application	<b>US9379</b>	3.2L V6 3199cc	2004	Base	<b>US9379</b>
<b>S500</b>				<b>SLK350</b>			
5.0L V8 4966cc	2000-2001	Base, Guard	<b>US9379</b>	3.5L V6 3498cc	2005-2006	Base; To 03/02/2005	<b>US6075</b>
5.0L V8 4966cc	2002	Base	<b>US9379</b>	3.5L V6 3498cc	2005-2006	Base; From 03/02/2005	<b>US6142</b>
5.0L V8 4966cc	2003-2006	4Matic, Base	<b>US9379</b>	3.5L V6 3498cc	2007-2011	Base	<b>US6142</b>
5.0L V8 4973cc	1994-1995	Base; To Engine 056885	<b>US9315</b>	<b>SLR MCLAREN</b>			
5.0L V8 4973cc	1994-1995	Base; From Engine 056886	<b>US9346</b>	5.5L V8 5439cc 335 CID	2005-2009	Base; Supercharged; Charge Air Cooling	<b>US11015</b>
5.0L V8 4973cc	1996-1999	Base	<b>US9346</b>	<b>SPRINTER</b>			
<b>S500L</b>				<b>SPRINTER</b>			
5.5L V8 5461cc 333 CID	2007-2011	Mexican Application	<b>US9380</b>	2.7L L5 2685cc 165 CID	2004-2006	Mexican Application	<b>US6007</b>
<b>S550</b>				<b>SPRINTER 2500</b>			
4.6L V8 4663cc	2012-2013	4Matic, Base; Turbocharged	<b>US11015</b>	2.1L L4 2143cc 131 CID	2014	Base; Electric Water Pump, HVAC System	<b>US11009</b>
5.5L V8 5461cc	2007-2011	4Matic, Base	<b>US6235</b>	3.0L V6 2987cc	2010-2012	Base	<b>US6155</b>
<b>S600</b>				<b>SPRINTER 3500</b>			
5.5L V12 5513cc 336 CID	2003-2013	Base	<b>US6273</b>	2.1L L4 2143cc 131 CID	2014	Base; Electric Water Pump, HVAC System	<b>US11009</b>
5.5L V12 5513cc 336 CID	2003-2013	Base; Turbocharged; Auxiliary water pump	<b>US11015</b>	3.0L V6 2987cc	2010-2012	Base	<b>US6155</b>
5.8L V12 5786cc	2001-2002	Base	<b>US6273</b>	<b>MERCURY</b>			
6.0L V12 5980cc 365 CID	2015-2017	Base	<b>US6273</b>	<b>BOBCAT</b>			
6.0L V12 5987cc	1994-1999	Base	<b>US9277</b>	2.3L L4 140 CID	1975-1979		<b>US4005</b>
<b>S600L</b>				<b>BOBCAT</b>			
5.5L V12 5513cc 336 CID	2008-2009	Mexican Application	<b>US9380</b>	2.3L L4 140 CID	1980	Base, Runabout, Villager	<b>US4005</b>
				2.8L V6 171 CID	1975-1979		<b>US1047</b>

Engine	Years	Application Description	USMW	Engine	Years	Application Description	USMW
<b>MERCURY (cont'd.)</b>				<b>MERCURY (cont'd.)</b>			
<b>CALIENTE</b>				<b>COUGAR (cont'd.)</b>			
3.3L L6 3277cc 200 CID	1964-1967		US1044	3.8L V6 232 CID	1982	Base, GS, LS, XR-7	US4016
<b>CAPRI</b>				3.8L V6 232 CID	1983-1986	Base, LS	US4016
1.6L L4 1598cc 98 CID	1991-1994	Base, XR2	US4068	3.8L V6 232 CID	1987	LS	US4016
2.0L L4 1993cc 122 CID	1971-1974		US964	3.8L V6 232 CID	1988	LS	US4050
2.3L L4 140 CID	1975-1977		US4005	3.8L V6 232 CID	1989	LS, XR-7	US4050
2.3L L4 140 CID	1979		US4005	3.8L V6 232 CID	1990	XR-7	US4055
2.3L L4 140 CID	1980	Base, Ghia	US4005	3.8L V6 232 CID	1990-1992	LS	US4050
2.3L L4 140 CID	1981	Base, GS	US4005	3.8L V6 232 CID	1993	XR-7	US4050
2.3L L4 140 CID	1982	Base, Black Magic, GS, L	US4005	3.8L V6 232 CID	1994-1995	XR-7	US4090
2.3L L4 140 CID	1983	Base, Black Magic, Crimson Cat, GS, L	US4054	3.8L V6 232 CID	1996-1997	XR-7	US4103
2.3L L4 140 CID	1984	GS, RS Turbo	US4054	4.2L V8 255 CID	1980	XR-7	US4014
2.3L L4 140 CID	1985-1986	GS	US4054	4.2L V8 255 CID	1980	XR-7; High performance	US4014H
2.8L V6 171 CID	1979		US1047	4.2L V8 255 CID	1981	Base, XR-7	US4014
3.3L L6 200 CID	1979		US4002	4.2L V8 255 CID	1981	Base, XR-7; High performance	US4014H
3.3L L6 200 CID	1980	Base, Ghia	US4002	4.2L V8 255 CID	1982	XR-7	US4014
3.3L L6 200 CID	1981	Base, GS	US4002	4.2L V8 255 CID	1982	XR-7; High performance	US4014H
3.3L L6 200 CID	1982	Base, Black Magic, GS, L	US4002	4.6L V8 281 CID	1994-1997	XR-7; Pump Length: long	US4113
3.8L V6 232 CID	1983	Base, Black Magic, Crimson Cat, GS, L	US4016	5.0L V8 302 CID	1977-1979	WINDSOR	US953
3.8L V6 232 CID	1984-1986	GS	US4016	5.0L V8 302 CID	1977-1979	High performance	US953H
4.2L V8 255 CID	1980	Base, Ghia	US4024	5.0L V8 302 CID	1980-1981	XR-7	US4014
4.2L V8 255 CID	1980	Base, Ghia; High performance	US4024H	5.0L V8 302 CID	1980-1981	XR-7; High performance	US4014H
4.2L V8 255 CID	1981	Base, GS	US4024	5.0L V8 302 CID	1983-1985	Base, LS	US4014
4.2L V8 255 CID	1981	Base, GS; High performance	US4024H	5.0L V8 302 CID	1983-1985	Base, LS; High performance	US4014H
4.2L V8 255 CID	1982	Base, Black Magic, GS, L, RS	US4024	5.0L V8 302 CID	1986	Base, LS	US4038
4.2L V8 255 CID	1982	Base, Black Magic, GS, L, RS; High performance	US4024H	5.0L V8 302 CID	1986	Base, LS; High performance	US4038H
5.0L V8 302 CID	1979		US4024	5.0L V8 302 CID	1987-1988	LS, XR-7	US4038
5.0L V8 302 CID	1979	High performance	US4024H	5.0L V8 302 CID	1987-1988	LS, XR-7; High performance	US4038H
5.0L V8 302 CID	1982-1983	RS; High performance	US4024H	5.0L V8 302 CID	1991-1992	LS, XR-7	US4057
5.0L V8 302 CID	1982-1985	RS	US4024	5.0L V8 302 CID	1993	XR-7	US4057
5.0L V8 302 CID	1984	RS; Exc.CFI, High performance	US4024H	5.8L V8 351 CID	1975-1979	MODIFIED	US932
5.0L V8 302 CID	1985	RS; High performance	US4024H	5.8L V8 351 CID	1975-1979	WINDSOR	US953
5.0L V8 302 CID	1985	RS	US4035	5.8L V8 351 CID	1975-1979	High performance	US953H
5.0L V8 302 CID	1986	5.0	US4038	6.6L V8 400 CID	1975-1978	MODIFIED	US932
5.0L V8 302 CID	1986	5.0; High performance	US4038H	7.5L V8 460 CID	1975-1976		US1114
<b>COLONY PARK</b>				<b>COUNTRY CRUISER</b>			
5.0L V8 302 CID	1987	GS, LS	US4014	3.3L L6 3277cc 200 CID	1963		US1044
5.0L V8 302 CID	1987	GS, LS; High performance	US4014H	6.4L V8 6391cc 390 CID	1963		US723
5.0L V8 302 CID	1988	GS, LS; To 06/1988	US4014	<b>CUSTOM</b>			
5.0L V8 302 CID	1988	GS, LS; High performance, To 06/88	US4014H	4.2L V8 4196cc 256 CID	1954		US488
5.0L V8 302 CID	1988	GS, LS; From 06/1988	US4052	5.1L V8 5114cc 312 CID	1956		US488
5.0L V8 302 CID	1988	GS, LS; From 06/88, High performance	US4052H	<b>CYCLONE</b>			
5.0L V8 302 CID	1989-1991	GS, LS	US4052	3.3L L6 3277cc 200 CID	1964		US1044
5.0L V8 302 CID	1989-1991	GS, LS; High performance	US4052H	<b>GRAND MARQUIS</b>			
5.8L V8 5769cc 352 CID	1961-1962		US723	4.2L V8 255 CID	1981-1982	Base	US4014
6.4L V8 6391cc 390 CID	1961-1964		US723	4.2L V8 255 CID	1981-1982	Base; High performance	US4014H
6.6L V8 6654cc 406 CID	1962-1963		US723	4.6L V8 281 CID	1992-1993	GS, LS	US4066
7.0L V8 6997cc 427 CID	1963-1964		US723	4.6L V8 281 CID	1994	GS, LS; From 04/94	US4066
<b>COMET</b>				4.6L V8 281 CID	1994	GS, LS; To 03/94	US4066
2.4L L6 144 CID	1961-1963		US1044	4.6L V8 281 CID	1995-1997	GS, LS	US4066
2.4L L6 2360cc 144 CID	1960-1963		US1044	4.6L V8 281 CID	1996	GS, LS; From 03/96	US4066
2.8L L6 170 CID	1964		US1044	4.6L V8 281 CID	1996	GS, LS; To 03/96	US4066
2.8L L6 170 CID	1971-1972		US1044	4.6L V8 281 CID	1998-2000	GS, LS; Pump Length: long	US4113
2.8L L6 2786cc 170 CID	1961-1972		US1044	4.6L V8 281 CID	2001-2002	GS, LS; Long Housing, Pump Length: long	US4113
3.3L L6 200 CID	1965		US1044	4.6L V8 281 CID	2001-2002	GS, LS; Short Housing	US4128
3.3L L6 200 CID	1968		US1044	4.6L V8 281 CID	2003	GS, LS, LSE	US4128
3.3L L6 200 CID	1971-1974		US1044	4.6L V8 281 CID	2004	GS, LS	US4128
3.3L L6 200 CID	1975	W/O AIR	US1044	4.6L V8 281 CID	2005	GS, GSL, Limited Edition, LS, Ultimate Edition	US4128
3.3L L6 200 CID	1975	Air Cond	US4002	4.6L V8 281 CID	2006-2008	GS, LS	US4128
3.3L L6 200 CID	1976-1977		US4002	4.6L V8 281 CID	2009-2011	LS	US4128
3.3L L6 3277cc 200 CID	1963-1974		US1044	5.0L V8 302 CID	1979		US4014
3.3L L6 3278cc 200 CID	1968		US1044	5.0L V8 302 CID	1979	High performance	US4014H
3.3L L6 3278cc 200 CID	1971-1974		US1044	5.0L V8 302 CID	1980-1982	Base, Colony Park	US4014
4.1L L6 250 CID	1975-1977		US960	5.0L V8 302 CID	1980-1982	Base, Colony Park; High performance	US4014H
5.0L V8 302 CID	1975-1977	WINDSOR	US953	5.0L V8 302 CID	1983	Base, LS	US4014
5.0L V8 302 CID	1975-1977	High performance	US953H	5.0L V8 302 CID	1983-1986	Base, Colony Park, LS; High performance	US4014H
<b>COMMUTER</b>				5.0L V8 302 CID	1984-1986	Base, Colony Park, LS	US4014
5.8L V8 5769cc 352 CID	1961-1962		US723	5.0L V8 302 CID	1987	GS, LS	US4014
6.4L V8 6391cc 390 CID	1961-1964		US723	5.0L V8 302 CID	1987	GS, LS; High performance	US4014H
6.6L V8 6654cc 406 CID	1962-1963		US723	5.0L V8 302 CID	1988	GS, LS; To 06/1988	US4014
7.0L V8 6997cc 427 CID	1963-1964		US723	5.0L V8 302 CID	1988	GS, LS; High performance, To 06/88	US4014H
<b>COUGAR</b>				5.0L V8 302 CID	1988	GS, LS; From 06/1988	US4052
2.0L L4 1989cc 121 CID	1999-2002	Base	US4115	5.0L V8 302 CID	1988	GS, LS; From 06/88, High performance	US4052H
2.3L L4 140 CID	1984-1986	XR-7	US4054	5.0L V8 302 CID	1988	GS, LS	US4052
2.5L V6 2450cc 155 CID	1999-2000	V6	US4091	5.0L V8 302 CID	1989-1991	GS, LS	US4052
2.5L V6 2450cc 155 CID	1999-2000	V6; Includes back housing	US4091-2	5.0L V8 302 CID	1989-1991	GS, LS; High performance	US4052H
2.5L V6 2450cc 155 CID	2001	Base, S, V6	US4091	5.8L V8 351 CID	1979		US4014
2.5L V6 2450cc 155 CID	2001	Base, S, V6; Includes back housing	US4091-2	5.8L V8 351 CID	1979	High performance	US4014H
2.5L V6 2450cc 155 CID	2002	Base, V6	US4091	5.8L V8 351 CID	1980-1981	Base, Colony Park	US4014
2.5L V6 2450cc 155 CID	2002	Base, V6; Includes back housing	US4091-2	5.8L V8 351 CID	1980-1981	Base, Colony Park; High performance	US4014H
3.3L L6 200 CID	1980	XR-7	US4002	5.8L V8 351 CID	1986	Base, LS	US4014
3.3L L6 200 CID	1981	Base, XR-7	US4002	5.8L V8 351 CID	1986	Base, LS; High performance	US4014H
3.3L L6 200 CID	1982	Base, GS, LS, XR-7	US4002	5.8L V8 5800cc 351 CID	1977-1978	Mexican Application	US932

WATER PUMP



Engine	Years	Application Description	USMW
<b>MERCURY (cont'd.)</b>			
<b>GRAND MARQUIS (cont'd.)</b>			
5.8L V8 5800cc 351 CID	1979-1981	Mexican Application	<b>US4052</b>
<b>LN7</b>			
1.6L L4 1598cc 98 CID	1982	Base	<b>US4040</b>
1.6L L4 1598cc 98 CID	1983	Base, Grand Sport, RS, Sport	<b>US4040</b>
<b>LYNX</b>			
1.6L L4 1598cc 98 CID	1981	Base, GL, GS, LS, RS	<b>US4040</b>
1.6L L4 1598cc 98 CID	1982	Base, GL, GS, L, LS, RS	<b>US4040</b>
1.6L L4 1598cc 98 CID	1983-1984	Base, GL, GS, LS, LTS, RS	<b>US4040</b>
1.6L L4 1598cc 98 CID	1985	Base, GL, GS, L, XR3	<b>US4040</b>
1.9L L4 116 CID	1985	Base, GL, GS, L, XR3	<b>US4040</b>
1.9L L4 116 CID	1986	Base, GS, L, XR3	<b>US4040</b>
1.9L L4 116 CID	1987	GS, L, XR3	<b>US4040</b>
2.0L L4 1989cc 122 CID	1984	Base, GL, GS, RS	<b>US9067</b>
2.0L L4 1989cc 122 CID	1985	Base, GL, GS, L, XR3	<b>US9067</b>
2.0L L4 1989cc 122 CID	1986-1987	GS, L	<b>US9067</b>
<b>MARAUDER</b>			
4.6L V8 281 CID	2003-2004	Base	<b>US4128</b>
6.4L V8 6391cc 390 CID	1963-1964		<b>US723</b>
6.6L V8 6654cc 406 CID	1963		<b>US723</b>
7.0L V8 6997cc 427 CID	1963-1964		<b>US723</b>
<b>MARINER</b>			
2.3L L4 140 CID	2005	Base	<b>US4126</b>
2.3L L4 140 CID	2006-2007	Convenience, Hybrid	<b>US4126</b>
2.3L L4 140 CID	2006-2008	Hybrid; Electric Water Pump	<b>US11002</b>
2.3L L4 140 CID	2008	Base, Hybrid	<b>US4126</b>
2.5L L4 2488cc 152 CID	2009-2010	Base, Hybrid, Premier	<b>US4126</b>
2.5L L4 2488cc 152 CID	2009-2011	Hybrid; Electric Water Pump, From Reservoir	<b>US11001</b>
2.5L L4 2488cc 152 CID	2009-2011	Hybrid; Electric Water Pump, Heater	<b>US11007</b>
2.5L L4 2488cc 152 CID	2011	Base, Hybrid	<b>US4126</b>
3.0L V6 2968cc 181 CID	2005	Premier	<b>US4132</b>
3.0L V6 2968cc 181 CID	2005	Premier; Includes back housing	<b>US4132-2</b>
3.0L V6 2968cc 181 CID	2006	Luxury, Premier; To 01/30/2006	<b>US4132</b>
3.0L V6 2968cc 181 CID	2006	Luxury, Premier; Includes back housing, To 01/30/2006	<b>US4132-2</b>
3.0L V6 2968cc 181 CID	2006	Luxury, Premier; From 01/30/2006	<b>US9489</b>
3.0L V6 2968cc 181 CID	2006	Luxury, Premier; From 01/30/2006, Includes back housing	<b>US9489-2</b>
3.0L V6 2968cc 181 CID	2007	Luxury, Premier	<b>US9489</b>
3.0L V6 2968cc 181 CID	2007	Luxury, Premier; Includes back housing	<b>US9489-2</b>
3.0L V6 2968cc 181 CID	2008	Base, Premier	<b>US9489</b>
3.0L V6 2968cc 181 CID	2008	Base, Premier; Includes back housing	<b>US9489-2</b>
3.0L V6 2968cc 181 CID	2009-2011	Base, Premier	<b>US6250</b>
<b>MARQUIS</b>			
2.3L L4 140 CID	1983-1986	Base, Brougham	<b>US4054</b>
3.3L L6 200 CID	1983	Base, Brougham	<b>US4002</b>
3.8L V6 232 CID	1983-1986	Base, Brougham	<b>US4016</b>
4.2L V8 255 CID	1981-1982	Base, Brougham	<b>US4014</b>
4.2L V8 255 CID	1981-1982	Base, Brougham; High performance	<b>US4014H</b>
5.0L V8 302 CID	1979	WINDSOR	<b>US953</b>
5.0L V8 302 CID	1979	High performance	<b>US953H</b>
5.0L V8 302 CID	1980-1982	Base, Brougham	<b>US4014</b>
5.0L V8 302 CID	1980-1982	Base, Brougham; High performance	<b>US4014H</b>
5.8L V8 351 CID	1978-1979	MODIFIED	<b>US932</b>
5.8L V8 351 CID	1978-1979	WINDSOR	<b>US953</b>
5.8L V8 351 CID	1978-1979	High performance	<b>US953H</b>
5.8L V8 351 CID	1980-1981	Base, Brougham	<b>US4014</b>
5.8L V8 351 CID	1980-1981	Base, Brougham; High performance	<b>US4014H</b>
6.6L V8 400 CID	1975-1978	MODIFIED	<b>US932</b>
7.5L V8 460 CID	1975-1978		<b>US1114</b>
<b>MEDALIST</b>			
5.1L V8 5114cc 312 CID	1956		<b>US488</b>
5.1L V8 5114cc 312 CID	1958		<b>US488</b>
<b>METEOR</b>			
2.8L L6 170 CID	1962-1963		<b>US1044</b>
2.8L L6 2786cc 170 CID	1961-1963		<b>US1044</b>
3.3L L6 3277cc 200 CID	1963		<b>US1044</b>
4.8L V8 4786cc 292 CID	1961		<b>US488</b>
5.8L V8 5769cc 352 CID	1961-1962		<b>US723</b>
6.4L V8 6391cc 390 CID	1961-1963		<b>US723</b>
<b>MILAN</b>			
2.3L L4 140 CID	2006-2009	Base, Premier	<b>US4126</b>
2.5L L4 2488cc 152 CID	2010-2011	Base, Hybrid, Premier	<b>US4126</b>
3.0L V6 2968cc 181 CID	2006-2009	Base, Premier	<b>US9489</b>
3.0L V6 2968cc 181 CID	2006-2009	Base, Premier; Includes back housing	<b>US9489-2</b>
3.0L V6 2968cc 181 CID	2010-2011	Premier	<b>US6250</b>
<b>MONARCH</b>			
3.3L L6 200 CID	1975	W/O AIR	<b>US1044</b>
3.3L L6 200 CID	1975	Air Cond	<b>US4002</b>
3.3L L6 200 CID	1976-1977		<b>US4002</b>
4.1L L6 250 CID	1975-1979		<b>US960</b>

Engine	Years	Application Description	USMW
<b>MERCURY (cont'd.)</b>			
<b>MONARCH (cont'd.)</b>			
4.1L L6 250 CID	1980	Base	<b>US960</b>
4.2L V8 255 CID	1980	Base; WINDSOR	<b>US953</b>
4.2L V8 255 CID	1980	Base; High performance	<b>US953H</b>
5.0L V8 302 CID	1975-1979	WINDSOR	<b>US953</b>
5.0L V8 302 CID	1975-1979	High performance	<b>US953H</b>
5.0L V8 302 CID	1980	Base; WINDSOR	<b>US953</b>
5.0L V8 302 CID	1980	Base; High performance	<b>US953H</b>
5.8L V8 351 CID	1975-1977	WINDSOR	<b>US953</b>
5.8L V8 351 CID	1975-1977	High performance	<b>US953H</b>
<b>MONTECLAIR</b>			
5.1L V8 5114cc 312 CID	1956-1957		<b>US488</b>
5.1L V8 5114cc 312 CID	1960		<b>US488</b>
6.4L V8 6391cc 390 CID	1964		<b>US723</b>
7.0L V8 6997cc 427 CID	1964		<b>US723</b>
<b>MONTEGO</b>			
3.0L V6 2968cc 181 CID	2005	Base, Premier	<b>US6186</b>
3.0L V6 2968cc 181 CID	2006-2007	Luxury, Premier	<b>US6186</b>
3.3L L6 200 CID	1968		<b>US1044</b>
3.3L L6 3277cc 200 CID	1968		<b>US1044</b>
3.3L L6 3278cc 200 CID	1968		<b>US1044</b>
5.8L V8 351 CID	1975-1976	MODIFIED	<b>US932</b>
5.8L V8 351 CID	1975-1976	WINDSOR	<b>US953</b>
5.8L V8 351 CID	1975-1976	High performance	<b>US953H</b>
6.6L V8 400 CID	1975-1976	MODIFIED	<b>US932</b>
7.5L V8 460 CID	1975-1976		<b>US1114</b>
<b>MONTEREY</b>			
4.2L V6 256 CID	2004-2005	Base, Premier	<b>US4102</b>
4.2L V6 256 CID	2006-2007	Luxury	<b>US4102</b>
4.2L V8 4196cc 256 CID	1954		<b>US488</b>
4.8L V8 4786cc 292 CID	1961-1962		<b>US488</b>
5.1L V8 5114cc 312 CID	1956-1957		<b>US488</b>
5.1L V8 5114cc 312 CID	1959-1960		<b>US488</b>
5.8L V8 5769cc 352 CID	1961-1962		<b>US723</b>
6.4L V8 390 CID	1962-1963		<b>US723</b>
6.4L V8 6391cc 390 CID	1961-1964		<b>US723</b>
6.6L V8 6654cc 406 CID	1962-1963		<b>US723</b>
7.0L V8 6997cc 427 CID	1963-1964		<b>US723</b>
<b>MOUNTAINEER</b>			
4.0L V6 245 CID	1998-2003	Base	<b>US4108</b>
4.0L V6 245 CID	2004-2005	Base, Premier	<b>US4108</b>
4.0L V6 245 CID	2006	Convenience, Luxury	<b>US4108</b>
4.0L V6 245 CID	2007-2010	Base, Premier	<b>US4108</b>
4.6L V8 281 CID	2002-2003	Base	<b>US8920</b>
4.6L V8 281 CID	2004-2005	Base, Premier	<b>US8920</b>
4.6L V8 281 CID	2006	Luxury, Premier	<b>US8920</b>
4.6L V8 281 CID	2007-2010	Premier	<b>US8920</b>
5.0L V8 302 CID	1997-2001	Base	<b>US4101</b>
<b>MYSTIQUE</b>			
2.0L L4 1989cc 121 CID	1995	Base, GS, GS Spree, LS	<b>US4088</b>
2.0L L4 1989cc 121 CID	1996-1997	GS, LS	<b>US4088</b>
2.0L L4 1989cc 121 CID	1998	GS; From 12/1997	<b>US4115</b>
2.0L L4 1989cc 121 CID	1998	GS; To 12/1997	<b>US4115</b>
2.0L L4 1989cc 121 CID	1999-2000	GS	<b>US4115</b>
2.5L V6 2450cc 155 CID	1995	Base, GS, GS Spree, LS Young America	<b>US4091</b>
2.5L V6 2450cc 155 CID	1995	Base, GS, GS Spree, LS Young America; Includes back housing	<b>US4091-2</b>
2.5L V6 2450cc 155 CID	1996-1997	GS, LS	<b>US4091</b>
2.5L V6 2450cc 155 CID	1996-1997	GS, LS; Includes back housing	<b>US4091-2</b>
2.5L V6 2450cc 155 CID	1998-2000	LS	<b>US4091</b>
2.5L V6 2450cc 155 CID	1998-2000	LS; Includes back housing	<b>US4091-2</b>
<b>PARK LANE</b>			
6.4L V8 6391cc 390 CID	1964		<b>US723</b>
7.0L V8 6997cc 427 CID	1964		<b>US723</b>
<b>SABLE</b>			
2.5L L4 153 CID	1986	GS	<b>US4056</b>
3.0L V6 2968cc 181 CID	1996	LS	<b>US4098</b>
3.0L V6 2968cc 181 CID	1997	GS, LS	<b>US4098</b>
3.0L V6 2968cc 181 CID	1998	GS, LS, LS Premium	<b>US4098</b>
3.0L V6 2968cc 181 CID	1999	GS, LS	<b>US4098</b>
3.0L V6 2968cc 181 CID	2000	LS, LS Premium	<b>US4098</b>
3.0L V6 2968cc 181 CID	2001	LS, LS Premium	<b>US4091</b>
3.0L V6 2968cc 181 CID	2001	LS, LS Premium; Includes back housing	<b>US4091-2</b>
3.0L V6 2968cc 181 CID	2002	LS Premium	<b>US4091</b>
3.0L V6 2968cc 181 CID	2002	LS Premium; Includes back housing	<b>US4091-2</b>
3.0L V6 2968cc 181 CID	2003	LS Premium; To 04/01/2003	<b>US4091</b>
3.0L V6 2968cc 181 CID	2003	LS Premium; Includes back housing, To 04/01/2003	<b>US4091-2</b>
3.0L V6 2968cc 181 CID	2003	LS	<b>US4094</b>
3.0L V6 2968cc 181 CID	2003	LS Premium; From 04/01/2003	<b>US4132</b>
3.0L V6 2968cc 181 CID	2003	LS Premium; From 04/01/2003, Includes back housing	<b>US4132-2</b>

Engine	Years	Application Description	USMW	Engine	Years	Application Description	USMW
<b>MERCURY (cont'd.)</b>				<b>MINI (cont'd.)</b>			
<b>SABLE (cont'd.)</b>				<b>COOPER (cont'd.)</b>			
3.0L V6 2968cc 181 CID	2004	LS Premium	US4132	1.6L L4 1598cc	2008	Base, Clubman, S, S Clubman	US6244
3.0L V6 2968cc 181 CID	2004	LS Premium; Includes back housing	US4132-2	1.6L L4 1598cc	2009-2011	Base, Clubman, John Cooper Works, John Cooper Works Clubman, S, S Clubman	US6244
3.0L V6 2968cc 181 CID	2005	LS, Platinum Edition	US4132	1.6L L4 1598cc	2012	Base, Clubman, Coupe, Coupe John Cooper Works, John Cooper Works Clubman, Roadster, Roadster John Cooper Works, Roadster S, S Clubman	US6244
3.0L V6 2968cc 181 CID	2005	LS, Platinum Edition; Includes back housing	US4132-2	1.6L L4 1598cc	2013	Base, Clubman, Coupe, Coupe John Cooper Works, John Cooper Works Clubman, John Cooper Works GP, Roadster, Roadster John Cooper Works, Roadster S, S, S Clubman	US6244
3.0L V6 2986cc 182 CID	1986-1993	GS, LS	US4034	1.6L L4 1598cc	2014	Base, Clubman, Coupe, Coupe John Cooper Works, John Cooper Works Clubman, Roadster, Roadster John Cooper Works, Roadster S, S, S Clubman	US6244
3.0L V6 2986cc 182 CID	1994	GS, LS; From 02/1994	US4034	1.6L L4 1598cc	2015	Base, Clubman, Coupe, Coupe John Cooper Works, John Cooper Works Clubman, Roadster, Roadster John Cooper Works, Roadster S, S	US6244
3.0L V6 2986cc 182 CID	1994	GS, LS; To 01/1994	US4034	1.6L L4 1598cc 98 CID	2011-2013	Mexican Application	US6244
3.0L V6 2986cc 182 CID	1995	GS, LS, LTS	US4094	1.6L L4 1598cc 98 CID	2014	John Cooper Works, S Clubman	US6244
3.0L V6 2986cc 182 CID	1996	G, GS	US4094	1.6L L4 1598cc 98 CID	2015	John Cooper Works	US6244
3.0L V6 2986cc 182 CID	1997	GS	US4094	1.6L L4 1600cc	2002-2008	S	US6001
3.0L V6 2986cc 182 CID	1998	GS, LS, LS Premium	US4094	1.6L L4 1600cc	2002-2008	Base	US9474
3.0L V6 2986cc 182 CID	1999-2002	GS, LS	US4094	<b>COOPER COUNTRYMAN</b>			
3.0L V6 2986cc 182 CID	2003-2005	GS	US4094	1.6L L4 1598cc	2011-2012	Base, S, S ALL4	US6244
3.5L V6 3496cc 213 CID	2008-2009	Base, Premier	US6023	1.6L L4 1598cc	2013-2016	Base, John Cooper Works ALL4, S, S ALL4	US6244
3.8L V6 232 CID	1988-1993	GS, LS	US4051	1.6L L4 1598cc 98 CID	2014-2016	John Cooper Works ALL4	US6244
3.8L V6 232 CID	1994-1995	GS, LS	US4089	<b>COOPER PACEMAN</b>			
<b>TOPAZ</b>				1.6L L4 1598cc	2013-2016	Base, John Cooper Works ALL4, S, S ALL4	US6244
2.0L L4 1989cc 122 CID	1984-1986	Base, GS, LS	US9067	<b>MITSUBISHI</b>			
2.3L L4 140 CID	1984-1986	Base, GS, LS	US4022	<b>3000GT</b>			
2.3L L4 140 CID	1987	GS, GS AWD, LS, LS AWD, Sport, Sport AWD, XR5	US4022	3.0L V6 2972cc 181 CID	1991-1994	Base, SL, VR-4	US7129
2.3L L4 140 CID	1988-1989	GS, GS AWD, LS, LS AWD, LTS, Sport, Sport AWD, XR5	US4022	3.0L V6 2972cc 181 CID	1995-1996	Base, SL, Spyder SL, Spyder VR-4, VR-4	US7129
2.3L L4 140 CID	1990-1991	GS, GS AWD, LS, LS AWD, LTS, LTS AWD, Sport, Sport AWD, XR5, XR5 AWD	US4022	3.0L V6 2972cc 181 CID	1997-1999	Base	US7121
2.3L L4 140 CID	1992	GS, LS, LTS, Sport	US4041	3.0L V6 2972cc 181 CID	1997-1999	Base; With back plate housing	US7121-2
2.3L L4 140 CID	1993	GS; From 05/1993	US4041	3.0L V6 2972cc 181 CID	1997-1999	SL, VR-4	US7129
2.3L L4 140 CID	1993	GS; To 05/1993	US4041	<b>CORDIA</b>			
2.3L L4 140 CID	1994	GS	US4041	1.8L L4 1795cc	1983	Base, L, LS	US7118
2.3L L4 2300cc 140 CID	1984-1989	Mexican Application	US4022	1.8L L4 1795cc	1984-1988	Turbo	US7118
3.0L V6 2986cc 182 CID	1992	GS, LS, LTS, Sport, XR5	US4070	2.0L L4 1997cc 122 CID	1984	Base, L, LS	US7118
3.0L V6 2986cc 182 CID	1993-1994	GS	US4070	2.0L L4 1997cc 122 CID	1985-1988	L	US7118
<b>TRACER</b>				<b>DIAMANTE</b>			
1.6L L4 1598cc 98 CID	1988-1989	Base	US4049	3.0L V6 2972cc 181 CID	1992-1994	ES	US7121
1.8L L4 112 CID	1991-1996	LTS	US4068	3.0L V6 2972cc 181 CID	1992-1994	ES; With back plate housing	US7121-2
1.9L L4 116 CID	1991	Base, Trio; To 04/91	US4065	3.0L V6 2972cc 181 CID	1992-1994	LS	US7129
1.9L L4 116 CID	1991	Base, Trio; From 04/91	US4069	3.0L V6 2972cc 181 CID	1995	ES, LS	US7121
1.9L L4 116 CID	1992-1993	Base, Trio	US4069	3.0L V6 2972cc 181 CID	1995	ES, LS; With back plate housing	US7121-2
1.9L L4 116 CID	1994	Base, Trio; From 06/1994	US4069	3.0L V6 2972cc 181 CID	1996	ES	US7121
1.9L L4 116 CID	1994	Base, Trio; To 05/1994	US4069	3.0L V6 2972cc 181 CID	1996	ES; With back plate housing	US7121-2
1.9L L4 116 CID	1995-1996	Base, Trio	US4069	3.5L V6 3497cc 215 CID	1997-1998	ES, LS	US7152
2.0L L4 1989cc 121 CID	1997-1999	GS, LS, Trio	US4107	3.5L V6 3497cc 215 CID	1999	Base	US7152
<b>VILLAGER</b>				3.5L V6 3497cc 215 CID	2000-2001	ES, LS	US7152
2.4L L6 2360cc 144 CID	1962-1963		US1044	3.5L V6 3497cc 215 CID	2002-2004	ES, LS, VR-X	US7152
2.8L L6 2786cc 170 CID	1962-1967		US1044	<b>ECLIPSE</b>			
3.0L V6 182 CID	1993	GS, LS	US9074	1.8L L4 1755cc 107 CID	1990-1994	Base, GS	US7108
3.0L V6 182 CID	1994-1998	GS, LS, Nautica	US9074	2.0L L4 1997cc 122 CID	1990-1994	GS, GST, GSX	US9212
3.3L L6 3277cc 200 CID	1963-1967		US1044	2.0L L4 1997cc 122 CID	1995	GST, GSX	US7148
3.3L V6 3275cc	1999-2002	Base, Estate, Sport	US9402	2.0L L4 1997cc 122 CID	1995	GS, RS	US7150
<b>VOYAGER</b>				2.0L L4 1997cc 122 CID	1996-1997	Base, GS, RS	US7150
2.8L L6 2786cc 170 CID	1966-1967		US1044	2.0L L4 1997cc 122 CID	1996-1999	GST, GSX, Spyder GST	US7148
3.3L L6 3277cc 200 CID	1966-1967		US1044	2.0L L4 1997cc 122 CID	1998-1999	GS, RS	US7150
<b>ZEPHYR</b>				2.4L L4 2351cc	1996-1999	Spyder GS	US7148
2.3L L4 140 CID	1978-1979		US4005	2.4L L4 2351cc	2000	GS, RS	US9399
2.3L L4 140 CID	1980-1981	Base, Z7	US4005	2.4L L4 2351cc	2001-2004	GS, RS, Spyder GS	US9399
2.3L L4 140 CID	1982	Base, GS, Z7	US4005	2.4L L4 2351cc	2005	GS, Spyder GS	US9399
2.3L L4 140 CID	1983	Base, GS, Z7, Z7 GS	US4054	2.4L L4 2378cc	2006	GS	US6149
3.3L L6 200 CID	1978-1979		US4002	2.4L L4 2378cc	2007	GS, Spyder GS	US6149
3.3L L6 200 CID	1980-1981	Base, Z7	US4002	2.4L L4 2378cc	2008	GS, SE, Spyder GS	US6149
3.3L L6 200 CID	1982	Base, GS, Z7	US4002	2.4L L4 2378cc	2009	GS, Spyder GS	US6149
3.3L L6 200 CID	1983	Base, GS, Z7, Z7 GS	US4002	2.4L L4 2378cc	2010-2011	GS, GS Sport, Spyder GS	US6149
4.2L V8 255 CID	1980-1981	Base, Z7; WINDSOR	US953	3.0L V6 2972cc 181 CID	2000	GT	US7152
4.2L V8 255 CID	1980-1981	Base, Z7; High performance	US953H	3.0L V6 2972cc 181 CID	2001-2002	GT, Spyder GT	US7152
4.2L V8 255 CID	1982	Base, GS; WINDSOR	US953	3.0L V6 2972cc 181 CID	2003	GT, GTS, Spyder GT, Spyder GTS	US7152
4.2L V8 255 CID	1982	Base, GS; High performance	US953H	3.0L V6 2972cc 181 CID	2004	GT, GTS, Spyder GT, Spyder GTS; From 10/2003	US7152
5.0L V8 302 CID	1978-1979	WINDSOR	US953	3.0L V6 2972cc 181 CID	2004	GT, GTS, Spyder GT, Spyder GTS; To 09/03	US7152
5.0L V8 302 CID	1978-1979	High performance	US953H	3.0L V6 2972cc 181 CID	2005	GT, GTS, Spyder GT, Spyder GTS	US7152
<b>MERKUR</b>				<b>MG</b>			
<b>SCORPIO</b>				<b>MGB</b>			
2.9L V6 177 CID	1988-1989	Base	US4042	1.8L L4 1798cc	1972-1980		US9082
<b>XR4TI</b>				<b>MINI</b>			
2.3L L4 140 CID	1985-1989	Base	US4054	<b>COOPER</b>			
<b>MG</b>				1.6L L4 1598cc	2007	Base, S	US6244
<b>MGB</b>							

WATER PUMPS



# WATER PUMP APPLICATION GUIDE



Engine	Years	Application Description	USMW
<b>MITSUBISHI (cont'd.)</b>			
<b>ECLIPSE (cont'd.)</b>			
3.8L V6 3828cc 230 CID	2006	GT	US7152
3.8L V6 3828cc 230 CID	2007	GT, Spyder GT	US7152
3.8L V6 3828cc 230 CID	2008	GT, SE, Spyder GT	US7152
3.8L V6 3828cc 230 CID	2009-2011	GT, Spyder GT	US7152
<b>ENDEAVOR</b>			
3.8L V6 3797cc 230 CID	2004	Limited, LS, XLS; From 10/2003	US7152
3.8L V6 3797cc 230 CID	2004	Limited, LS, XLS; To 09/03	US7152
3.8L V6 3828cc 230 CID	2005	Limited, LS, XLS	US7152
3.8L V6 3828cc 230 CID	2006	Limited, LS	US7152
3.8L V6 3828cc 230 CID	2007-2008	LS, SE	US7152
3.8L V6 3828cc 230 CID	2010-2011	LS, SE	US7152
3.8L V6 3828cc 234 CID	2010-2011	Mexican Application	US7152
<b>EXPO</b>			
2.4L L4 2351cc	1992	Base, SP	US9168
2.4L L4 2351cc	1993	Base, SP	US7148
2.4L L4 2351cc	1994-1995	Base	US7148
<b>EXPO LRV</b>			
1.8L L4 1834cc 112 CID	1992	Base, Sport	US7135
1.8L L4 1834cc 112 CID	1993	Base; From 04/1993	US7135
1.8L L4 1834cc 112 CID	1993	Base; To 03/1993	US7135
1.8L L4 1834cc 112 CID	1994	Base	US7135
2.4L L4 2351cc	1993-1994	Base, Sport	US7148
<b>GALANT</b>			
2.0L L4 1997cc 122 CID	1989	GS	US9212
2.0L L4 1997cc 122 CID	1989-1992	Base, LS	US9168
2.0L L4 1997cc 122 CID	1990	GS, GSX	US9212
2.0L L4 1997cc 122 CID	1991-1992	GS, GSR, GSX, VR-4	US9212
2.0L L4 1997cc 122 CID	1993	ES, LS, S	US7148
2.4L L4 2351cc	1985-1987	Base	US7118
2.4L L4 2351cc	1994	ES, GS, LS, S	US7148
2.4L L4 2351cc	1995-1996	ES, LS, S	US7148
2.4L L4 2351cc	1997-1998	DE, ES, LS	US7148
2.4L L4 2351cc	1999-2001	DE, ES	US9399
2.4L L4 2351cc	2002-2003	DE, ES, LS	US9399
2.4L L4 2351cc	2004	DE, ES	US6149
2.4L L4 2378cc	2005-2007	DE, ES, SE	US6149
2.4L L4 2378cc	2008	DE, ES	US6149
2.4L L4 2378cc	2009	ES, Sport Edition	US6149
2.4L L4 2378cc	2010-2011	ES, SE	US6149
3.0L V6 2972cc 181 CID	1988	Sigma	US7121
3.0L V6 2972cc 181 CID	1988	Sigma; With back plate housing	US7121-2
3.0L V6 2972cc 181 CID	1999-2003	ES, GTZ, LS	US7152
3.8L V6 3828cc 230 CID	2004	GTS, LS; From 10/2003	US7152
3.8L V6 3828cc 230 CID	2004	GTS, LS; TO 10/03	US7152
3.8L V6 3828cc 230 CID	2005-2006	GTS, LS	US7152
3.8L V6 3828cc 230 CID	2007	GTS, Ralliart	US7152
3.8L V6 3828cc 230 CID	2008	Ralliart	US7152
3.8L V6 3828cc 230 CID	2009	Ralliart, Sport V6	US7152
<b>GRANDIS</b>			
2.4L L4 2378cc 145 CID	2007-2009	Mexican Application	US9399
<b>L200</b>			
2.4L L4 2378cc 145 CID	2008-2012	Mexican Application	US9399
<b>LANCER</b>			
2.0L L4 1997cc 122 CID	2005	Evolution, Evolution MR, Evolution RS; To 07/05	US6159
2.0L L4 1998cc 122 CID	2008	DE, ES, Evolution GSR, Evolution MR, GTS	US6038
2.0L L4 1998cc 122 CID	2009	DE, ES, Ralliart	US6038
2.0L L4 1998cc 122 CID	2010	DE, ES, Evolution GSR, Evolution MR, Evolution MR Touring, Ralliart, Ralliart Sportback	US6038
2.0L L4 1998cc 122 CID	2011	DE, ES, ES Sportback, Evolution GSR, Evolution MR, Evolution MR Touring, Ralliart, Ralliart Sportback	US6038
2.0L L4 1999cc 122 CID	2005	ES, OZ Rally	US9360
2.0L L4 1999cc 122 CID	2006	ES, OZ Rally, SE	US9360
2.0L L4 1999cc 122 CID	2007	ES	US9360
2.0L L4 2000cc	2002-2004	ES, LS, OZ Rally	US9360
2.0L L4 2000cc	2003-2004	Evolution	US6159
2.4L L4 2360cc 144 CID	2009	GTS	US6038
2.4L L4 2360cc 144 CID	2010-2011	GTS, GTS Sportback	US6038
2.4L L4 2378cc	2005-2006	Ralliart	US6149
2.4L L4 2400cc	2004	Ralliart, Sportback, Sportback Ralliart	US6149
<b>MIGHTY MAX</b>			
2.0L L4 1997cc 122 CID	1983-1984	Base, S	US7114
2.0L L4 1997cc 122 CID	1985-1989	Base	US7114
2.3L L4 2346cc 143 CID	1983	SP	US7117
2.3L L4 2346cc 143 CID	1984	SP, SPX	US7117
2.3L L4 2346cc 143 CID	1985	SP, SPX; From 10/1984	US7117
2.3L L4 2346cc 143 CID	1985	SP, SPX; To 09/1984	US7117
2.4L L4 2351cc	1990-1992	1 Ton, Base	US7114
2.4L L4 2351cc	1993-1996	Base	US7114
2.6L L4 2555cc 156 CID	1983-1985	SP, SPX	US7120

Engine	Years	Application Description	USMW
<b>MITSUBISHI (cont'd.)</b>			
<b>MIGHTY MAX (cont'd.)</b>			
2.6L L4 2555cc 156 CID	1986	Base, Sport, SPX	US7120
2.6L L4 2555cc 156 CID	1987	1 Ton, Base, Sport, SPX	US7120
2.6L L4 2555cc 156 CID	1988	1 Ton, Sport, SPX	US7120
2.6L L4 2555cc 156 CID	1989	1 Ton, Base, Sport, SPX	US7120
3.0L V6 2972cc 181 CID	1990-1994	Base	US7121
3.0L V6 2972cc 181 CID	1990-1994	Base; With back plate housing	US7121-2
<b>MIRAGE</b>			
1.2L L3 1193cc 73 CID	2015-2016	GLS, GLX	US8143
1.2L L3 1193cc 73 CID	2017-2018	ES, GLS, GLX, GT, SE	US8143
1.5L L4 1468cc 90 CID	1985	Base, L, LS	US7115
1.5L L4 1468cc 90 CID	1986-1987	Base, L	US7115
1.5L L4 1468cc 90 CID	1988	L	US7115
1.5L L4 1468cc 90 CID	1989	Base, LS	US7115
1.5L L4 1468cc 90 CID	1990	Base, RS, VL	US7115
1.5L L4 1468cc 90 CID	1991-1992	Base, LS, SE, VL	US7115
1.5L L4 1468cc 90 CID	1993	ES, LS, S	US7115
1.5L L4 1468cc 90 CID	1994-1995	ES, S	US7115
1.5L L4 1468cc 90 CID	1996	S	US7115
1.5L L4 1468cc 90 CID	1997-2002	DE	US9359
1.6L L4 1597cc 98 CID	1985-1988	Turbo	US7108
1.6L L4 1597cc 98 CID	1989	Turbo	US7131
1.6L L4 1597cc 98 CID	1991-1992	GS	US7131
1.8L L4 1834cc 112 CID	1993	ES, LS; From 04/1993	US7135
1.8L L4 1834cc 112 CID	1993	ES, LS; To 03/1993	US7135
1.8L L4 1834cc 112 CID	1994-1995	ES, LS	US7135
1.8L L4 1834cc 112 CID	1996	LS	US7135
1.8L L4 1834cc 112 CID	1997-1999	LS	US9360
1.8L L4 1834cc 112 CID	2000	DE, LS	US9360
1.8L L4 1834cc 112 CID	2001	ES, LS	US9360
1.8L L4 1834cc 112 CID	2002	LS	US9360
<b>MIRAGE G4</b>			
1.2L L3 1193cc 73 CID	2017-2018	ES	US8143
<b>MONTERO</b>			
2.6L L4 2555cc 156 CID	1983	Base	US7120
2.6L L4 2555cc 156 CID	1984	Base, Sport	US7120
2.6L L4 2555cc 156 CID	1985-1986	Base	US7120
2.6L L4 2555cc 156 CID	1987-1988	Base, Sport	US7120
2.6L L4 2555cc 156 CID	1989	Base, SP	US7120
3.0L V6 2972cc 181 CID	1989	Base, LS, SP, Sport	US7121
3.0L V6 2972cc 181 CID	1989	Base, LS, SP, Sport; With back plate housing	US7121-2
3.0L V6 2972cc 181 CID	1990	Base, LS, RS, SP, Sport	US7121
3.0L V6 2972cc 181 CID	1990	Base, LS, RS, SP, Sport; With back plate housing	US7121-2
3.0L V6 2972cc 181 CID	1991	Base, LS, RS	US7121
3.0L V6 2972cc 181 CID	1991	Base, LS, RS; With back plate housing	US7121-2
3.0L V6 2972cc 181 CID	1992-1993	Base, LS, RS, SR	US7121
3.0L V6 2972cc 181 CID	1992-1993	Base, LS, RS, SR; With back plate housing	US7121-2
3.0L V6 2972cc 181 CID	1994	LS	US7121
3.0L V6 2972cc 181 CID	1994	LS; With back plate housing	US7121-2
3.0L V6 2972cc 181 CID	1995-1996	LS	US9460
3.5L V6 3497cc 215 CID	1994-1995	SR	US9310
3.5L V6 3497cc 215 CID	1996	SR; To 04/1996	US9310
3.5L V6 3497cc 215 CID	1996	SR; From 05/1996	US9460
3.5L V6 3497cc 215 CID	1997	LS, SR	US9460
3.5L V6 3497cc 215 CID	1998-2000	Base	US9460
3.5L V6 3497cc 215 CID	2001-2002	Limited, XLS	US9415
3.8L V6 3797cc 230 CID	2003-2004	Limited, XLS	US9415
3.8L V6 3797cc 230 CID	2005	Limited	US9415
3.8L V6 3800cc 232 CID	2008-2009	Mexican Application	US7152
3.8L V6 3828cc 230 CID	2006	Limited	US9415
3.8L V6 3828cc 234 CID	2010	Mexican Application	US7152
<b>MONTERO LIMITED</b>			
3.8L V6 3828cc 234 CID	2011	Mexican Application	US7152
<b>MONTERO SPORT</b>			
2.4L L4 2351cc	1997-1999	ES	US9389
3.0L V6 2972cc 181 CID	1997-1999	LS, XLS	US9460
3.0L V6 2972cc 181 CID	2000-2001	ES, LS, XLS	US9460
3.0L V6 2972cc 181 CID	2002-2003	ES, LS	US9460
3.5L V6 3497cc 215 CID	2005-2008	Mexican Application	US7152
3.5L V6 3497cc 215 CID	1999-2000	Limited	US9460
3.5L V6 3497cc 215 CID	2001	Limited, XS	US9460
3.5L V6 3497cc 215 CID	2002-2003	Limited, XLS	US9460
3.5L V6 3497cc 215 CID	2004	LS, XLS	US9460
<b>OUTLANDER</b>			
2.4L L4 2351cc	2003	LS, XLS	US6228
2.4L L4 2351cc	2004	LS, XLS	US6149
2.4L L4 2360cc 144 CID	2008-2011	ES, SE	US6038
2.4L L4 2378cc	2005	Limited, LS, XLS	US6149
2.4L L4 2378cc	2006	Limited, LS, SE	US6149
3.0L V6 2998cc 182 CID	2007	ES, LS, XLS	US6240
3.0L V6 2998cc 182 CID	2008	LS, XLS	US6240



Engine	Years	Application Description	USMW	Engine	Years	Application Description	USMW
<b>MITSUBISHI (cont'd.)</b>				<b>NISSAN (cont'd.)</b>			
<b>OUTLANDER (cont'd.)</b>				<b>300ZX</b>			
3.0L V6 2998cc 182 CID	2009	XLS	<b>US6240</b>	3.0L V6 2960cc	1984-1986	2+2, Base, Turbo	<b>US9058</b>
3.0L V6 2998cc 182 CID	2010-2011	GT, XLS	<b>US6240</b>	3.0L V6 2960cc	1987	2+2, Base, Turbo; From 05/87	<b>US9058</b>
<b>OUTLANDER SPORT</b>				3.0L V6 2960cc	1987	2+2, Base, Turbo; To 05/87	<b>US9058</b>
2.0L L4 1998cc 122 CID	2011	ES, SE	<b>US6038</b>	3.0L V6 2960cc	1988-1989	2+2, Base, Turbo	<b>US9058</b>
<b>PRECIS</b>				3.0L V6 2960cc	1990-1996	2+2, Base, Turbo	<b>US9201</b>
1.5L L4 1468cc	1987	Base, LS	<b>US7115</b>	<b>310</b>			
1.5L L4 1468cc	1988-1989	Base, LS, RS	<b>US7115</b>	1.4L L4 1393cc 85 CID	1980	Deluxe, GX	<b>US9010</b>
1.5L L4 1468cc	1990-1991	Base, RS	<b>US7115</b>	1.5L L4 1488cc	1981	Deluxe, GX	<b>US9010</b>
1.5L L4 1468cc	1992-1994	Base	<b>US7115</b>	1.5L L4 1488cc	1982	Deluxe, GX	<b>US9041</b>
<b>RAIDER</b>				<b>350Z</b>			
3.7L V6 226 CID	2006-2007	DuroCross, LS	<b>US7163</b>	3.5L V6 3498cc	2003-2004	Base, Enthusiast, Performance, Touring, Track	<b>US9426</b>
3.7L V6 226 CID	2008-2009	LS	<b>US7163</b>	3.5L V6 3498cc	2005	35th Anniversary Edition, Base, Enthusiast, Grand Touring, Performance, Touring, Track	<b>US9426</b>
4.7L V8 287 CID	2006	DuroCross, XLS	<b>US7163</b>	3.5L V6 3498cc	2006	Base, Enthusiast, Grand Touring, Touring, Track	<b>US9426</b>
4.7L V8 287 CID	2007	LS, SE	<b>US7163</b>	3.5L V6 3498cc	2007-2008	Base, Enthusiast, Grand Touring, Nismo, Touring	<b>US8164</b>
<b>SIGMA</b>				3.5L V6 3498cc	2009	Enthusiast, Grand Touring, Touring	<b>US8164</b>
3.0L V6 2972cc 181 CID	1989-1990	Base	<b>US7121</b>	3.5L V6 3498cc 213 CID	2003	Touring	<b>US9426</b>
3.0L V6 2972cc 181 CID	1989-1990	Base; With back plate housing	<b>US7121-2</b>	<b>370Z</b>			
<b>SPACE STAR</b>				3.7L V6 3696cc	2009	Base, Nismo, Touring	<b>US8164</b>
1.8L L4 1755cc 107 CID	2003-2004	Mexican Application	<b>US9360</b>	3.7L V6 3696cc	2010	40th Anniversary Edition, Base, Nismo, Touring	<b>US8164</b>
<b>STARION</b>				3.7L V6 3696cc	2011-2014	Base, Nismo, Touring	<b>US8164</b>
2.6L L4 2555cc 156 CID	1983	Base, LS	<b>US7120</b>	3.7L V6 3696cc	2015-2017	Base, Nismo, Nismo Tech, Sport, Sport Tech, Touring, Touring Sport	<b>US8164</b>
2.6L L4 2555cc 156 CID	1984	ES, LE, LS	<b>US7120</b>	3.7L V6 3696cc 226 CID	2010-2016	Touring	<b>US8164</b>
2.6L L4 2555cc 156 CID	1985	ES, ESi, LE	<b>US7120</b>	<b>411</b>			
2.6L L4 2555cc 156 CID	1986	ESi-R, LE	<b>US7120</b>	1.3L L4 1299cc 79 CID	1965-1967		<b>US9179</b>
2.6L L4 2555cc 156 CID	1987	ESi-R	<b>US7120</b>	<b>510</b>			
2.6L L4 2555cc 156 CID	1987	ESi-R, LE; From 12/1986	<b>US7124</b>	2.0L L4 1952cc	1978		<b>US9031</b>
2.6L L4 2555cc 156 CID	1988	ESi, ESi-R	<b>US7124</b>	2.0L L4 1952cc	1978-1979	Exc.Air Cond	<b>US9008</b>
2.6L L4 2555cc 156 CID	1989	ESi-R	<b>US7124</b>	2.0L L4 1952cc	1979	To 01/79	<b>US9031</b>
<b>TREDIA</b>				2.0L L4 1952cc	1980-1981	Base; Exc.Air Cond	<b>US9008</b>
1.8L L4 1795cc	1983	Base, L, LS	<b>US7118</b>	2.0L L4 1952cc	1980-1981	Base; With air cond.	<b>US9031</b>
1.8L L4 1795cc	1984-1988	Turbo	<b>US7118</b>	<b>520 PICKUP</b>			
2.0L L4 1997cc 122 CID	1984	Base, L, LS	<b>US7118</b>	1.3L L4 1299cc 79 CID	1965-1968		<b>US9179</b>
2.0L L4 1997cc 122 CID	1985	Base, L	<b>US7118</b>	<b>521 PICKUP</b>			
2.0L L4 1997cc 122 CID	1986	Base, L, LS	<b>US7118</b>	1.3L L4 1299cc 79 CID	1968-1969		<b>US9179</b>
2.0L L4 1997cc 122 CID	1987-1988	L, LS	<b>US7118</b>	<b>610</b>			
<b>VAN</b>				2.0L L4 1952cc	1975-1976	Exc.Air Cond	<b>US9008</b>
2.4L L4 2351cc	1987-1990	Base, LS	<b>US7114</b>	2.0L L4 1952cc	1975-1976	Air Cond	<b>US9031</b>
<b>NISSAN</b>				2.0L L4 1952cc	1976	Exc. air cond. (From 04/76)	<b>US9031</b>
<b>200SX</b>				2.0L L4 1952cc 119 CID	1974	Includes fan clutch	<b>US9031</b>
1.6L L4 1597cc 97 CID	1995	Base, SE	<b>US9214</b>	<b>620</b>			
1.6L L4 1597cc 97 CID	1996	Base, SE; From 11/1995	<b>US9214</b>	2.0L L4 1952cc	1975-1979	Exc.Air Cond	<b>US9008</b>
1.6L L4 1597cc 97 CID	1996	Base, SE; To 11/1995	<b>US9214</b>	2.0L L4 1952cc	1975-1979	Air Cond	<b>US9031</b>
1.6L L4 1597cc 97 CID	1997-1998	Base, SE	<b>US9214</b>	<b>710</b>			
1.8L L4 1809cc	1984-1986	Turbo	<b>US9063</b>	2.0L L4 1952cc	1975-1977	Exc.Air Cond	<b>US9008</b>
2.0L L4 1952cc	1977-1978		<b>US9031</b>	2.0L L4 1952cc	1975-1977	Air Cond	<b>US9031</b>
2.0L L4 1952cc	1979	From 02/79	<b>US9031</b>	2.0L L4 1952cc	1976	Air Cond (To 03/76)	<b>US9031</b>
2.0L L4 1952cc	1979	To 01/79	<b>US9031</b>	2.0L L4 1952cc	1976	From 04/76	<b>US9031</b>
2.0L L4 1952cc	1980-1981	Base	<b>US9031</b>	2.0L L4 1952cc	1977		<b>US9031</b>
2.0L L4 1974cc	1984-1986	Base, XE	<b>US9063</b>	<b>720</b>			
2.0L L4 1974cc	1984-1988	Includes fan clutch	<b>US9031</b>	2.0L L4 1952cc	1980	Deluxe; Automatic Trans; Exc.Air Cond	<b>US9008</b>
2.0L L4 1974cc	1987-1988	XE	<b>US9063</b>	2.0L L4 1952cc	1980	Base; Exc.Air Cond	<b>US9009</b>
2.0L L4 1998cc	1995-1998	SE-R	<b>US9213</b>	2.0L L4 1952cc	1980	Deluxe; Standard Trans; Exc.Air Cond	<b>US9009</b>
2.2L L4 2187cc	1982-1983	Base	<b>US9031</b>	2.0L L4 1952cc	1983-1984	Base, Deluxe; With air cond.	<b>US9031</b>
3.0L V6 2960cc 181 CID	1987	SE; From 04/1987	<b>US9058</b>	2.0L L4 1952cc	1985-1986	Base; Includes fan clutch	<b>US9031</b>
3.0L V6 2960cc 181 CID	1987	SE; To 04/1987	<b>US9058</b>	2.2L L4 2164cc	1981-1983	Deluxe	<b>US9198</b>
3.0L V6 2960cc 181 CID	1988	SE	<b>US9058</b>	2.2L L4 2187cc	1981-1983	Base, Deluxe; wo/Fan Clutch	<b>US9009</b>
<b>210</b>				2.2L L4 2187cc	1981-1983	Base, Deluxe; w/Fan Clutch	<b>US9031</b>
1.2L L4 1237cc	1980-1982	Base	<b>US9026</b>	2.4L L4 2389cc	1983-1984	Base, Deluxe	<b>US9031</b>
1.4L L4 1393cc 85 CID	1979	Air Cond	<b>US9026</b>	2.4L L4 2389cc	1985-1986	Base, Deluxe, Sport Truck; Includes fan clutch	<b>US9031</b>
1.4L L4 1393cc 85 CID	1980	Deluxe	<b>US9026</b>	2.5L L4 2488cc 152 CID	1983-1986	Deluxe	<b>US9198</b>
1.4L L4 1393cc 85 CID	1981	Base	<b>US9026</b>	<b>810</b>			
1.4L L4 1393cc 85 CID	1982	Base, MPG	<b>US9026</b>	2.4L L6 2393cc	1977-1979		<b>US9011</b>
1.5L L4 1488cc	1980-1982	Deluxe	<b>US9026</b>	2.4L L6 2393cc	1980	Base	<b>US9011</b>
<b>240SX</b>				2.4L L6 2393cc	1981	DX	<b>US9011</b>
2.4L L4 2389cc	1989-1990	SE, XE	<b>US9206</b>	2.8L L6 2793cc	1981	DX	<b>US9011</b>
2.4L L4 2389cc	1991-1992	Base, LE, SE	<b>US9206</b>	<b>ALMERA</b>			
2.4L L4 2389cc	1993	Base, SE	<b>US9206</b>	1.8L L4 1769cc 107 CID	2001	Mexican Application	<b>US9416</b>
2.4L L4 2389cc	1994	SE	<b>US9206</b>	1.8L L4 1769cc 107 CID	2005	Mexican Application	<b>US9416</b>
2.4L L4 2389cc	1995-1996	Base, SE	<b>US9206</b>	1.8L L4 1781cc 108 CID	2002-2004	Mexican Application	<b>US9416</b>
2.4L L4 2389cc	1997-1998	Base, LE, SE	<b>US9206</b>				
<b>280Z</b>							
2.8L L6 2753cc	1975-1978		<b>US9011</b>				
<b>280ZX</b>							
2.8L L6 2753cc	1979		<b>US9011</b>				
2.8L L6 2753cc	1980	2+2 GL, Base, GL	<b>US9011</b>				
2.8L L6 2753cc	1981	2+2 GL, Base, GL, GL Turbo	<b>US9011</b>				
2.8L L6 2753cc	1982-1983	2+2, 2+2 Turbo, Base, Turbo	<b>US9011</b>				

WATER PUMPS

Engine	Years	Application Description	USMW	Engine	Years	Application Description	USMW
<b>NISSAN (cont'd.)</b>				<b>NISSAN (cont'd.)</b>			
<b>ALTIMA</b>				<b>FRONTIER (cont'd.)</b>			
2.4L L4 2488cc	1993-2001	GLE, GXE, SE, XE	<b>US9270</b>	3.3L V6 3275cc	2000	SE, XE; From 12/1999	<b>US9338</b>
2.5L L4 2488cc 152 CID	2002-2004	Base, S, SL	<b>US9427</b>	3.3L V6 3275cc	2000	SE, XE; To 12/1999	<b>US9338</b>
2.5L L4 2488cc 152 CID	2002-2004	Base, S, SL; Includes back housing	<b>US9427-2</b>	3.3L V6 3275cc	2001	SC, SE, XE	<b>US9338</b>
2.5L L4 2488cc 152 CID	2005	S, SL; From 04/05	<b>US9427</b>	3.3L V6 3275cc	2002-2003	SC, SE, SVE, XE	<b>US9338</b>
2.5L L4 2488cc 152 CID	2005	S, SL; To 04/05	<b>US9427</b>	3.3L V6 3275cc	2004	SC, SVE, XE	<b>US9338</b>
2.5L L4 2488cc 152 CID	2005	S, SL; From 04/05, Includes back housing	<b>US9427-2</b>	4.0L V6 3954cc	2005	LE, Nismo Off-Road, SE	<b>US9426</b>
2.5L L4 2488cc 152 CID	2005	S, SL; Includes back housing, To 04/05	<b>US9427-2</b>	4.0L V6 3954cc	2006	LE, Nismo Off-Road, SE; From 09/2005	<b>US9426</b>
2.5L L4 2488cc 152 CID	2006	Base, S, SL	<b>US9427</b>	4.0L V6 3954cc	2006	LE, Nismo Off-Road, SE; To 09/2005	<b>US9426</b>
2.5L L4 2488cc 152 CID	2006	Base, S, SL; Includes back housing	<b>US9427-2</b>	4.0L V6 3954cc	2007	LE, Nismo Off-Road, SE; From 09/2006	<b>US9426</b>
2.5L L4 2488cc 152 CID	2007-2009	Base, Hybrid, S	<b>US9427</b>	4.0L V6 3954cc	2007	LE, Nismo Off-Road, SE; To 09/2006	<b>US9426</b>
2.5L L4 2488cc 152 CID	2007-2009	Base, Hybrid, S; Includes back housing	<b>US9427-2</b>	4.0L V6 3954cc	2008	LE, Nismo Off-Road, SE	<b>US9426</b>
2.5L L4 2488cc 152 CID	2010-2011	Base, Hybrid, S, SL	<b>US9427</b>	4.0L V6 3954cc	2009-2010	LE, PRO-4X, SE	<b>US9426</b>
2.5L L4 2488cc 152 CID	2010-2011	Base, Hybrid, S, SL; Includes back housing	<b>US9427-2</b>	4.0L V6 3954cc	2011-2012	PRO-4X, S, SL, SV	<b>US9426</b>
2.5L L4 2488cc 152 CID	2012	Base, S, SL	<b>US9427</b>	4.0L V6 3954cc	2013-2017	Desert Runner, PRO-4X, S, SL, SV	<b>US9426</b>
2.5L L4 2488cc 152 CID	2012	Base, S, SL; Includes back housing	<b>US9427-2</b>	4.0L V6 3954cc 241 CID	2008	SE	<b>US9426</b>
2.5L L4 2488cc 152 CID	2013	S; Includes back housing	<b>US9427-2</b>	4.0L V6 3954cc 241 CID	2010	SE	<b>US9426</b>
2.5L L4 2488cc 152 CID	2013-2015	Base, S, SL, SV	<b>US8105</b>	4.0L V6 3954cc 241 CID	2011	PRO-4X, SV	<b>US9426</b>
2.5L L4 2488cc 152 CID	2016-2017	Base, S, SL, SR, SV	<b>US8105</b>	4.0L V6 3954cc 241 CID	2012	PRO-4X	<b>US9426</b>
3.5L V6 3498cc	2002	SE; From 12/2001	<b>US9426</b>	4.0L V6 3954cc 241 CID	2014	PRO-4X, S	<b>US9426</b>
3.5L V6 3498cc	2002	SE; To 12/2001	<b>US9426</b>	4.0L V6 3954cc 241 CID	2015	PRO-4X	<b>US9426</b>
3.5L V6 3498cc	2003	SE; From 12/2002	<b>US9426</b>	<b>GT-R</b>			
3.5L V6 3498cc	2003	SE; To 12/2002	<b>US9426</b>	3.8L V6 3799cc	2009-2010	Base, Premium	<b>US8164</b>
3.5L V6 3498cc	2004	SE	<b>US9426</b>	3.8L V6 3799cc	2011	Premium	<b>US8164</b>
3.5L V6 3498cc	2005	SE, SE-R, SL; From 10/2004	<b>US9426</b>	3.8L V6 3799cc	2012-2013	Black Edition, Premium	<b>US8164</b>
3.5L V6 3498cc	2005	SE, SE-R, SL; To 10/2004	<b>US9426</b>	3.8L V6 3799cc	2014	Black Edition, Premium, Track Edition	<b>US8164</b>
3.5L V6 3498cc	2006	SE, SE-R, SL	<b>US9426</b>	3.8L V6 3799cc	2015	Black Edition, Nismo, Premium, Track Edition	<b>US8164</b>
3.5L V6 3498cc	2007-2009	SE, SL	<b>US6198</b>	3.8L V6 3799cc	2016	Black Edition, Nismo, Premium	<b>US8164</b>
3.5L V6 3498cc	2010-2012	SR	<b>US6198</b>	3.8L V6 3799cc	2017	Nismo, Premium	<b>US8164</b>
3.5L V6 3498cc	2013-2015	S, SL, SV	<b>US6198</b>	<b>HIKARI</b>			
3.5L V6 3498cc	2016-2017	SL, SR	<b>US6198</b>	1.6L L4 1597cc 97 CID	1988-1990	Base, Turbo	<b>US9284</b>
<b>APRIO</b>				1.6L L4 1597cc 97 CID	1991-1992	Turbo	<b>US9284</b>
1.6L L4 1597cc 97 CID	2008-2009	Mexican Application	<b>US8927</b>	<b>ICHI VAN</b>			
1.6L L4 1598cc 97 CID	2010	Mexican Application	<b>US8927</b>	1.8L L4 1800cc 110 CID	1987-1989	Mexican Application	<b>US9116</b>
1.6L L4 1598cc 98 CID	2008		<b>US8927</b>	1.8L L4 1800cc 110 CID	1990-1992	Mexican Application	<b>US9179</b>
1.6L L4 1598cc 98 CID	2010	Convenience	<b>US8927</b>	2.4L L4 2389cc 146 CID	1991-1994	Mexican Application	<b>US9206</b>
<b>ARMADA</b>				<b>JUKE</b>			
5.6L V8 5552cc	2005-2006	LE, SE, SE Off-Road	<b>US9488</b>	1.6L L4 1618cc	2011-2016	Mexican Application	<b>US8104</b>
5.6L V8 5552cc	2007-2009	LE, SE	<b>US9488</b>	1.6L L4 1618cc	2014-2017	Nismo, Nismo RS, S, SL, SV	<b>US8104</b>
5.6L V8 5552cc	2010	Platinum, SE, Titanium	<b>US9488</b>	<b>LUCINO</b>			
5.6L V8 5552cc	2011-2015	Platinum, SL, SV	<b>US9488</b>	1.6L L4 1597cc 97 CID	1996-2000	Mexican Application	<b>US9214</b>
5.6L V8 5552cc	2017	Platinum, SL, SV	<b>US9488</b>	2.0L L4 1998cc 122 CID	1996-2000	Mexican Application	<b>US9213</b>
<b>AXXESS</b>				<b>MARCH</b>			
2.4L L4 2389cc	1990	SE, XE	<b>US9162</b>	1.6L L4 1598cc 98 CID	2014-2016	Mexican Application	<b>US6687</b>
<b>B210</b>				<b>MAXIMA</b>			
1.4L L4 1393cc 85 CID	1975-1978	Exc.Air Cond	<b>US9010</b>	2.4L L6 2393cc	1982-1984	GL	<b>US9011</b>
1.4L L4 1393cc 85 CID	1975-1978	Air Cond	<b>US9026</b>	2.8L L6 2793cc	1982-1983	GL	<b>US9011</b>
<b>CABSTAR</b>				3.0L V6 2960cc 181 CID	1985-1986	GL, SE	<b>US9074</b>
2.5L L4 2488cc 151 CID	2008-2011	Mexican Application	<b>US8998</b>	3.0L V6 2960cc 181 CID	1987-1991	GXE, SE	<b>US9074</b>
<b>CUBE</b>				3.0L V6 2960cc 181 CID	1992-1994	GXE	<b>US9074</b>
1.8L L4 1798cc	2009-2011	Base, Krom, S, SL	<b>US6218</b>	3.0L V6 2960cc 181 CID	1992-1994	SE	<b>US9252</b>
1.8L L4 1798cc	2012	Base, S, SL	<b>US6218</b>	3.0L V6 2988cc 182 CID	1995-2000	GLE, GXE, SE	<b>US9309</b>
1.8L L4 1798cc	2013-2014	S, SL	<b>US6218</b>	3.0L V6 2988cc 182 CID	2001	GLE, GXE, SE, SE 20th Anniversary Edition	<b>US9309</b>
<b>D21</b>				3.5L H6 3500cc 214 CID	2010	Mexican Application	<b>US9426</b>
2.4L L4 2389cc	1986-1987	Base, E, XE; Includes fan clutch	<b>US9031</b>	3.5L V6 3498cc	2002-2003	GLE, GXE, SE	<b>US9426</b>
2.4L L4 2389cc	1988	Base, E, XE; From 04/1988, Incl.Fan Clutch,Gasket and Pulley	<b>US9031</b>	3.5L V6 3498cc	2004-2008	SE, SL	<b>US9426</b>
2.4L L4 2389cc	1988	Base, E, XE; To 04/1988	<b>US9031</b>	3.5L V6 3498cc	2009-2014	S, SV	<b>US6198</b>
2.4L L4 2389cc	1989	Base, E, XE; Includes fan clutch	<b>US9031</b>	3.5L V6 3498cc	2016-2017	Platinum, S, SL, SR, SV	<b>US6198</b>
2.4L L4 2389cc	1990-1993	Base	<b>US9206</b>	<b>MICRA</b>			
2.4L L4 2389cc	1994	Base, XE	<b>US9206</b>	1.4L L4 1386cc 85 CID	2006-2007		<b>US8967</b>
3.0L V6 2960cc	1986-1989	E, SE; RWD	<b>US9058</b>	<b>MURANO</b>			
3.0L V6 2960cc	1986-1989	E, SE; 4WD	<b>US9104</b>	2.5L L4 2488cc 152 CID	2016	Platinum Hybrid, SL Hybrid	<b>US8105</b>
3.0L V6 2960cc 181 CID	1990-1993	Base, SE; RWD	<b>US9058</b>	3.5L H6 3500cc 213 CID	2008	Mexican Application	<b>US9426</b>
3.0L V6 2960cc 181 CID	1990-1993	Base, SE; 4WD	<b>US9104</b>	3.5L V6 3498cc	2003	SE, SL; From 10/2002	<b>US9426</b>
3.0L V6 2960cc 181 CID	1994	Base	<b>US9058</b>	3.5L V6 3498cc	2003	SE, SL; To 10/2002	<b>US9426</b>
3.0L V6 2960cc 181 CID	1994	SE, XE; RWD	<b>US9058</b>	3.5L V6 3498cc	2004	SE, SL	<b>US9426</b>
3.0L V6 2960cc 181 CID	1994	SE, XE; 4WD	<b>US9104</b>	3.5L V6 3498cc	2005-2006	S, SE, SL	<b>US9426</b>
<b>FRONTIER</b>				3.5L V6 3498cc	2007	S, SE, SL; (VQ35DE); From 03/07	<b>US6198</b>
2.4L L4 2389cc	1998	Base, SE, XE	<b>US9206</b>	3.5L V6 3498cc	2007	S, SE, SL; To 03/2007	<b>US9426</b>
2.4L L4 2389cc	1999	SE, XE	<b>US9206</b>	3.5L V6 3498cc	2009	LE, S, SL; (VQ35DE)	<b>US6198</b>
2.4L L4 2389cc	2000-2001	XE	<b>US9206</b>	3.5L V6 3498cc	2010	LE, S, SL	<b>US6198</b>
2.4L L4 2389cc	2002-2003	Base, XE	<b>US9206</b>	3.5L V6 3498cc	2011-2014	CrossCabriolet, LE, S, SL, SV	<b>US6198</b>
2.4L L4 2389cc	2004	XE	<b>US9206</b>	3.5L V6 3498cc	2015-2017	Platinum, S, SL, SV	<b>US6198</b>
2.4L L4 2389cc 146 CID	2006	Mexican Application	<b>US6242</b>	<b>NP300</b>			
2.4L L4 2389cc 146 CID	2008	Mexican Application	<b>US9206</b>	2.4L L4 2389cc 146 CID	2009-2012	Mexican Application	<b>US9206</b>
2.5L L4 2488cc 152 CID	2005-2007	XE	<b>US6242</b>	2.5L L4 2488cc 151 CID	2008-2011	Mexican Application	<b>US8998</b>
2.5L L4 2488cc 152 CID	2008-2010	SE, XE	<b>US6242</b>	2.5L L4 2488cc 151 CID	2012	Mexican Application	<b>US9206</b>
2.5L L4 2488cc 152 CID	2011-2017	S, SV	<b>US6242</b>				
3.3L V6 3275cc	1999	SE, XE	<b>US9338</b>				

Engine	Years	Application Description	USMW	Engine	Years	Application Description	USMW
<b>NISSAN (cont'd.)</b>				<b>NISSAN (cont'd.)</b>			
<b>NV200</b>				<b>QUEST (cont'd.)</b>			
2.0L L4 1997cc	2013	SV; From 07/2013	<b>US6218</b>	3.5L V6 3498cc	2004	S, SE, SL	<b>US9426</b>
2.0L L4 1997cc	2014-2017	S, SV, Taxi	<b>US6218</b>	3.5L V6 3498cc	2005	Base, S, SE, SL; From 07/2005	<b>US9426</b>
<b>NV1500</b>				3.5L V6 3498cc	2005	Base, S, SE, SL; To 07/2005	<b>US9426</b>
4.0L V6 3954cc	2012-2017	S, SV	<b>US9426</b>	3.5L V6 3498cc	2006	Base, S, SE, SL; From 05/2006	<b>US9426</b>
<b>NV2500</b>				3.5L V6 3498cc	2006	Base, S, SE, SL; To 05/2006	<b>US9426</b>
4.0L V6 3954cc	2012-2014	S, SV	<b>US9426</b>	3.5L V6 3498cc	2007-2009	Base, S, SE, SL	<b>US9426</b>
4.0L V6 3954cc	2015-2016	S, SL, SV	<b>US9426</b>	3.5L V6 3498cc	2011-2014	LE, S, SL, SV	<b>US6198</b>
4.0L V6 3954cc	2017	S, SV	<b>US9426</b>	3.5L V6 3498cc	2015-2017	Platinum, S, SL, SV	<b>US6198</b>
5.6L V8 5552cc	2012-2014	S, SV	<b>US9488</b>	<b>ROGUE</b>			
5.6L V8 5552cc	2015-2017	S, SL, SV	<b>US9488</b>	2.5L L4 2488cc 152 CID	2008-2009	S, SL	<b>US9427</b>
<b>NV3500</b>				2.5L L4 2488cc 152 CID	2008-2009	S, SL; Includes back housing	<b>US9427-2</b>
4.0L V6 3954cc	2012-2017	S, SV	<b>US9426</b>	2.5L L4 2488cc 152 CID	2010	Krom, S, SL	<b>US9427</b>
5.6L V8 5552cc	2012-2017	S, SL, SV	<b>US9488</b>	2.5L L4 2488cc 152 CID	2010	Krom, S, SL; Includes back housing	<b>US9427-2</b>
<b>NX</b>				2.5L L4 2488cc 152 CID	2011	S, S Krom, SV	<b>US9427</b>
1.6L L4 1597cc 97 CID	1991-1993	SE, XE	<b>US9214</b>	2.5L L4 2488cc 152 CID	2011	S, S Krom, SV; Includes back housing	<b>US9427-2</b>
2.0L L4 1998cc	1991-1993	SE, XE	<b>US9213</b>	2.5L L4 2488cc 152 CID	2012-2013	S, SV	<b>US9427</b>
<b>PATHFINDER</b>				2.5L L4 2488cc 152 CID	2012-2013	S, SV; Includes back housing	<b>US9427-2</b>
2.4L L4 2389cc	1987	E; Includes fan clutch	<b>US9031</b>	2.5L L4 2488cc 152 CID	2014-2017	S, SL, SV	<b>US8105</b>
2.5L L4 2488cc 152 CID	2014	Platinum Hybrid, SL Hybrid, SV Hybrid	<b>US8105</b>	2.5L L4 2488cc 152 CID	2015-2016	S, SL, SV; USA Built	<b>US8105</b>
3.0L V6 2960cc 181 CID	1987-1993	SE, XE	<b>US9104</b>	2.5L L4 2488cc 152 CID	2016	S, SL, SV; Korea Built Vehicle (From 10/2015)	<b>US8105</b>
3.0L V6 2960cc 181 CID	1994-1995	LE, SE, XE	<b>US9104</b>	2.5L L4 2488cc 152 CID	2017	S, SL, SV; Korea Built Vehicle	<b>US8105</b>
3.3L V6 3275cc	1996	LE, SE, XE	<b>US9338</b>	<b>ROGUE SELECT</b>			
3.3L V6 3275cc	1997-1998	LE, SE, XE; (A)	<b>US9338</b>	2.5L L4 2488cc 152 CID	2014-2015	S	<b>US9427</b>
3.3L V6 3275cc	1999	LE, SE, XE; From 12/1998	<b>US9338</b>	2.5L L4 2488cc 152 CID	2014-2015	S; Includes back housing	<b>US9427-2</b>
3.3L V6 3275cc	1999	LE, SE, XE; To 12/1998	<b>US9338</b>	<b>ROGUE SPORT</b>			
3.3L V6 3275cc	2000	LE, SE, XE	<b>US9338</b>	2.0L L4 1997cc	2017	S, SL, SV	<b>US8104</b>
3.5L V6 3498cc	2001	LE, SE, XE	<b>US9309</b>	<b>SAKURA</b>			
3.5L V6 3498cc	2002-2004	LE, SE	<b>US9309</b>	1.8L L4 1750cc 107 CID	1982-1986	Mexican Application	<b>US9063</b>
3.5L V6 3498cc	2013-2016	Platinum, S, SL, SV	<b>US6198</b>	<b>SEDAN</b>			
4.0L V6 3954cc	2005	LE, SE, SE Off-Road, XE	<b>US9426</b>	1.6L L4 1597cc 97 CID	1973-1984	Mexican Application	<b>US9009</b>
4.0L V6 3954cc	2005	LE, SE, SE Off-Road, XE; Electric Water Pump	<b>US11005</b>	1.8L L4 1750cc 107 CID	1982-1984	Mexican Application	<b>US9063</b>
4.0L V6 3954cc	2006	LE, S, SE, SE Off-Road; From 09/2005	<b>US9426</b>	<b>SENTRA</b>			
4.0L V6 3954cc	2006	LE, S, SE, SE Off-Road; To 09/2005	<b>US9426</b>	1.5L L4 1488cc	1982-1983	Base, DX	<b>US9041</b>
4.0L V6 3954cc	2006-2009	LE, S, SE, SE Off-Road; Electric Water Pump	<b>US11005</b>	1.6L L4 1597cc	1983	Base, DX, XE	<b>US9041</b>
4.0L V6 3954cc	2007-2009	LE, S, SE, SE Off-Road	<b>US9426</b>	1.6L L4 1597cc	1984-1985	Base, DX, SE, XE	<b>US9041</b>
4.0L V6 3954cc	2010	LE, S, SE	<b>US9426</b>	1.6L L4 1597cc	1987-1988	Base, E, GXE, SE, XE	<b>US9041</b>
4.0L V6 3954cc	2010	LE, S, SE; Electric Water Pump	<b>US11005</b>	1.6L L4 1597cc 97 CID	1986	Base, DX, SE, XE	<b>US9041</b>
4.0L V6 3954cc	2011	LE, S, Silver Edition, SV; Electric Water Pump	<b>US11005</b>	1.6L L4 1597cc 97 CID	1987	Base, E, GXE, SE, XE	<b>US9041</b>
4.0L V6 3954cc	2011-2012	LE, S, Silver Edition, SV	<b>US9426</b>	1.6L L4 1597cc 97 CID	1989	Base, E, SE, XE	<b>US9207</b>
4.0L V6 3954cc	2012	LE, S, SV; Electric Water Pump	<b>US11005</b>	1.6L L4 1597cc 97 CID	1990	Base, SE, XE	<b>US9207</b>
4.0L V6 3954cc 241 CID	2010	LE, SE	<b>US9426</b>	1.6L L4 1597cc 97 CID	1991-1993	E, GXE, SE, XE	<b>US9214</b>
4.0L V6 3954cc 241 CID	2011	LE, SV	<b>US9426</b>	1.6L L4 1597cc 97 CID	1994	E, GXE, Limited Edition, SE, XE	<b>US9214</b>
5.6L V8 5552cc	2008	LE, SE	<b>US9488</b>	1.6L L4 1597cc 97 CID	1995	Base, GLE, GXE, XE; USA Built	<b>US9214</b>
5.6L V8 5552cc	2009-2012	LE	<b>US9488</b>	1.6L L4 1597cc 97 CID	1995-1997	Base, GLE, GXE, XE; Mexico Built Vehicle	<b>US9214</b>
<b>PATHFINDER ARMADA</b>				1.6L L4 1597cc 97 CID	1996	Base, GLE, GXE, XE; From 11/1995, USA Built	<b>US9214</b>
5.6L V8 5552cc	2004	LE, SE	<b>US9488</b>	1.6L L4 1597cc 97 CID	1996	Base, GLE, GXE, XE; To 11/1995, USA Built	<b>US9214</b>
<b>PICKUP</b>				1.6L L4 1597cc 97 CID	1997	Base, GLE, GXE, XE; USA Built	<b>US9214</b>
1.3L L4 1300cc 79 CID	1965-1969	Mexican Application	<b>US9179</b>	1.6L L4 1597cc 97 CID	1998	Base, GLE, GXE, XE	<b>US9214</b>
1.6L L4 1600cc 98 CID	1970-1983	Mexican Application	<b>US9009</b>	1.6L L4 1597cc 97 CID	1999	GXE, XE	<b>US9214</b>
1.8L L4 1800cc 110 CID	1981-1984	Mexican Application	<b>US9063</b>	1.6L L4 1597cc 97 CID	2000	Mexican Application	<b>US9213</b>
1.8L L4 1800cc 110 CID	1985-1990	Mexican Application	<b>US9116</b>	1.6L L4 1618cc	2017	Nismo, SR Turbo	<b>US8104</b>
1.8L L4 1800cc 110 CID	1991-1994	Mexican Application	<b>US9179</b>	1.7L L4 1688cc	1983	Base, DX	<b>US9044</b>
2.4L L4 2389cc	1995	Base, XE	<b>US9206</b>	1.7L L4 1688cc	1984	Base, DX, SE, XE	<b>US9044</b>
2.4L L4 2389cc	1996	Base, SE, XE; From 01/1996	<b>US9206</b>	1.7L L4 1688cc	1985-1986	Base	<b>US9044</b>
2.4L L4 2389cc	1996	Base, SE, XE; To 01/1996	<b>US9206</b>	1.8L L4 1798cc 110 CID	2013-2014	FE+S, FE+SV, S, SL, SR, SV	<b>US8104</b>
2.4L L4 2389cc	1997	Base, SE, XE	<b>US9206</b>	1.8L L4 1798cc 110 CID	2015-2016	FE+S, S, SL, SR, SV	<b>US8104</b>
2.4L L4 2389cc 146 CID	1991-1993	Mexican Application	<b>US9206</b>	1.8L L4 1798cc 110 CID	2017	S, SL, SR, SV	<b>US8104</b>
2.4L L4 2389cc 146 CID	1998-2008	Mexican Application	<b>US9206</b>	1.8L L4 1809cc	2000	GXE, XE	<b>US9416</b>
3.0L V6 2960cc 181 CID	1995	XE; RWD	<b>US9058</b>	1.8L L4 1809cc	2001-2002	CA, GXE, XE	<b>US9416</b>
3.0L V6 2960cc 181 CID	1995	SE, XE; 4WD	<b>US9104</b>	1.8L L4 1809cc	2003	GXE, XE	<b>US9416</b>
<b>PLATINA</b>				1.8L L4 1809cc	2004-2006	Base, S	<b>US9416</b>
1.6L L4 1597cc 97 CID	2010	Mexican Application	<b>US8927</b>	2.0L L4 1997cc 122 CID	2007-2008	Base, S, SL	<b>US6218</b>
1.6L L4 1598cc 97 CID	2002-2010	Mexican Application	<b>US8927</b>	2.0L L4 1997cc 122 CID	2009-2012	Base, S, SL, SR	<b>US6218</b>
1.6L L4 1598cc 98 CID	2002-2010		<b>US8927</b>	2.0L L4 1997cc 122 CID	2010-2012	Mexican Application	<b>US6218</b>
<b>PULSAR</b>				2.0L L4 1998cc	1991-1994	SE-R	<b>US9213</b>
1.6L L4 1597cc	1983	Base	<b>US9041</b>	2.0L L4 1998cc	1998-2001	SE	<b>US9213</b>
<b>PULSAR NX</b>				2.0L L4 1998cc 122 CID	1996-1997	Mexican Application	<b>US9213</b>
1.5L L4 1488cc	1983-1984	Turbo	<b>US9041</b>	2.5L L4 2488cc 152 CID	2002	SE-R, SE-R Spec V	<b>US9427</b>
1.6L L4 1597cc	1983-1986	Base	<b>US9041</b>	2.5L L4 2488cc 152 CID	2002	SE-R, SE-R Spec V; Includes back housing	<b>US9427-2</b>
1.6L L4 1597cc	1987	SE; To 10/1986	<b>US9063</b>	2.5L L4 2488cc 152 CID	2003	Limited Edition, SE-R, SE-R Spec V	<b>US9427</b>
1.6L L4 1597cc	1987	SE; From 10/1986	<b>US9116</b>	2.5L L4 2488cc 152 CID	2003	Limited Edition, SE-R, SE-R Spec V; Includes back housing	<b>US9427-2</b>
1.6L L4 1597cc	1987-1988	XE	<b>US9041</b>	2.5L L4 2488cc 152 CID	2004	S, SE-R, SE-R Spec V	<b>US9427</b>
1.6L L4 1597cc 97 CID	1989-1990	XE	<b>US9207</b>	2.5L L4 2488cc 152 CID	2004	S, SE-R, SE-R Spec V; Includes back housing	<b>US9427-2</b>
1.8L L4 1809cc	1988-1989	SE	<b>US9116</b>	2.5L L4 2488cc 152 CID	2005-2012	SE-R, SE-R Spec V	<b>US9427</b>
<b>QUEST</b>				2.5L L4 2488cc 152 CID	2005-2012	SE-R, SE-R Spec V; Includes back housing	<b>US9427-2</b>
3.0L V6 2960cc 181 CID	1993-1998	GXE, XE	<b>US9074</b>				
3.3L V6 3275cc	1999-2002	GLE, GXE, SE	<b>US9402</b>				

WATER PUMPS





# WATER PUMP APPLICATION GUIDE



Engine	Years	Application Description	USMW	Engine	Years	Application Description	USMW
<b>NISSAN (cont'd.)</b>				<b>OLDSMOBILE (cont'd.)</b>			
<b>STANZA</b>				<b>98 (cont'd.)</b>			
2.0L L4 1974cc	1982	Base	<b>US9114</b>	3.8L V6 3800cc 231 CID	1996	Regency Elite	<b>US5075</b>
2.0L L4 1974cc	1983	Base, GL	<b>US9114</b>	4.1L V6 252 CID	1981	Luxury, Regency	<b>US1018</b>
2.0L L4 1974cc	1984-1986	GL, XE	<b>US9114</b>	4.1L V6 252 CID	1981	Luxury, Regency; High performance	<b>US1018H</b>
2.0L L4 1974cc	1987-1989	E, GXE, XE	<b>US9116</b>	4.1L V6 252 CID	1982-1983	Regency, Regency Brougham	<b>US1018</b>
2.4L L4 2389cc	1990-1991	GXE, XE	<b>US9162</b>	4.1L V6 252 CID	1982-1983	Regency, Regency Brougham; High performance	<b>US1018H</b>
2.4L L4 2389cc	1992	GXE, SE, XE	<b>US9162</b>	4.3L V6 260 CID	1985	Regency, Regency Brougham; W/O Pulley	<b>US5014</b>
<b>STATION WAGON</b>				4.3L V6 260 CID	1985	Regency, Regency Brougham; Includes pulley	<b>US5014P</b>
1.6L L4 1597cc 97 CID	1973-1984	Mexican Application	<b>US9009</b>	5.0L V8 307 CID	1980-1981	Luxury, Regency; Exc.Air Cond	<b>US1100</b>
1.8L L4 1750cc 107 CID	1982-1984	Mexican Application	<b>US9063</b>	5.0L V8 307 CID	1980-1981	Luxury, Regency; With air cond.	<b>US1120</b>
<b>TIIDA</b>				5.0L V8 307 CID	1980-1981	Luxury, Regency; High performance, With air cond.	<b>US1120H</b>
1.8L L4 1798cc 110 CID	2010-2012	Mexican Application	<b>US6218</b>	5.0L V8 307 CID	1982-1984	Regency, Regency Brougham	<b>US1120</b>
<b>TITAN</b>				5.0L V8 307 CID	1982-1984	Regency, Regency Brougham; High performance	<b>US1120H</b>
5.6L V8 5552cc	2004-2007	LE, SE, XE	<b>US9488</b>	5.7L V8 350 CID	1977-1979	Exc.Air Cond	<b>US1100</b>
5.6L V8 5552cc	2008-2010	LE, PRO-4X, SE, XE	<b>US9488</b>	5.7L V8 350 CID	1977-1979	Air Cond	<b>US1120</b>
5.6L V8 5552cc	2011-2015	PRO-4X, S, SL, SV	<b>US9488</b>	5.7L V8 350 CID	1977-1979	Air Cond, High performance	<b>US1120H</b>
5.6L V8 5552cc	2017	Platinum Reserve, PRO-4X, S, SL, SV	<b>US9488</b>	5.7L V8 350 CID	1980-1981	Luxury, Regency; Exc.Air Cond	<b>US1100</b>
<b>TITAN XD</b>				5.7L V8 350 CID	1980-1981	Luxury, Regency; With air cond.	<b>US1120</b>
5.6L V8 5552cc	2016-2017	Platinum Reserve, PRO-4X, S, SL, SV	<b>US9488</b>	5.7L V8 350 CID	1980-1981	Luxury, Regency; High performance, With air cond.	<b>US1120H</b>
<b>TSUBAME</b>				5.7L V8 350 CID	1982-1984	Regency, Regency Brougham	<b>US1120</b>
1.6L L4 1597cc 97 CID	1993-2004	Mexican Application	<b>US9214</b>	5.7L V8 350 CID	1982-1984	Regency, Regency Brougham; High performance	<b>US1120H</b>
<b>TSURU</b>				6.6L V8 400 CID	1975	Exc.Air Cond	<b>US1100</b>
1.5L L4 1487cc 91 CID	1984-1985	Mexican Application	<b>US9041</b>	6.6L V8 400 CID	1975	Air Cond	<b>US1120</b>
1.5L L4 1488cc	1985		<b>US9284</b>	6.6L V8 400 CID	1975	Air Cond, High performance	<b>US1120H</b>
1.6L L4 1597cc 97 CID	1986-1987		<b>US9284</b>	6.6L V8 403 CID	1977-1979	Exc.Air Cond	<b>US1100</b>
1.6L L4 1597cc 97 CID	1988-2013	Mexican Application	<b>US9214</b>	6.6L V8 403 CID	1977-1979	Air Cond	<b>US1120</b>
1.6L L4 1598cc 97 CID	1995-1997	Mexican Application	<b>US9214</b>	6.6L V8 403 CID	1977-1979	Air Cond, High performance	<b>US1120H</b>
2.0L L4 1998cc 122 CID	1993-1996	Mexican Application	<b>US9213</b>	7.0L V8 6966cc 425 CID	1965-1967	Without A/C	<b>US773</b>
<b>URVAN</b>				7.5L V8 455 CID	1968-1970	With A/C	<b>US926</b>
2.4L L4 2389cc 146 CID	2000-2005	Mexican Application	<b>US9206</b>	7.5L V8 455 CID	1975-1976	Exc.Air Cond	<b>US1100</b>
2.4L L4 2392cc 146 CID	2006-2007	Mexican Application	<b>US9206</b>	7.5L V8 455 CID	1975-1976	Air Cond	<b>US1120</b>
2.5L L4 2488cc 152 CID	2008-2013	Base	<b>US6242</b>	7.5L V8 455 CID	1975-1976	Air Cond, High performance	<b>US1120H</b>
2.5L L4 2500cc 153 CID	2008	Mexican Application	<b>US6242</b>	7.5L V8 7456cc 455 CID	1968-1970		<b>US773</b>
2.5L L4 2500cc 153 CID	2011-2013	Mexican Application	<b>US6242</b>	<b>442</b>			
3.0L L4 2999cc 182 CID	2008-2010	Mexican Application	<b>US8978</b>	6.6L V8 6555cc 400 CID	1968-1969	With A/C	<b>US926</b>
3.0L L4 3000cc 183 CID	2011	Mexican Application	<b>US8978</b>	7.5L V8 7456cc 455 CID	1968-1970	With A/C	<b>US926</b>
<b>VAN</b>				<b>ACHIEVA</b>			
2.4L L4 2389cc	1987-1988	E, GXE, XE	<b>US9110</b>	2.3L L4 138 CID	1992	S, SC, SL	<b>US5043</b>
<b>VERSA</b>				2.3L L4 138 CID	1993	S, SL	<b>US5043</b>
1.6L L4 1598cc	2009-2011	1.6, 1.6 Base	<b>US6687</b>	2.3L L4 138 CID	1994	S, SC, SL	<b>US5043</b>
1.6L L4 1598cc	2014-2017	1.6 S, 1.6 SL, 1.6 S Plus, 1.6 SV	<b>US6687</b>	2.3L L4 138 CID	1995	S, SL	<b>US5043</b>
1.8L L4 1798cc	2007-2011	S, SL	<b>US6218</b>	2.3L L4 140 CID	1992	S, SC, SCX	<b>US5043</b>
1.8L L4 1798cc	2012	1.8 S, 1.8 SL	<b>US6218</b>	2.3L L4 140 CID	1993	S, SCX	<b>US5043</b>
<b>VERSA NOTE</b>				2.3L L4 140 CID	1994	SC, SL	<b>US5043</b>
1.6L L4 1598cc	2014	S, S Plus, SV	<b>US6687</b>	2.4L L4 2392cc 146 CID	1996	S, SC, SL	<b>US5076</b>
1.6L L4 1598cc	2015-2016	S, SL, S Plus, SR, SV	<b>US6687</b>	2.4L L4 2392cc 146 CID	1997	SC, SL	<b>US5076</b>
1.6L L4 1598cc	2017	SL, S Plus, SR, SV	<b>US6687</b>	2.4L L4 2392cc 146 CID	1998	S	<b>US5076</b>
<b>XTERRA</b>				3.1L V6 189 CID	1994	S, SC, SL	<b>US5033</b>
2.4L L4 2389cc	2000-2004	XE	<b>US9206</b>	3.1L V6 189 CID	1995	S, SL	<b>US5033</b>
3.3L V6 3275cc	2000	SE, XE; From 12/1999	<b>US9338</b>	3.1L V6 189 CID	1996	S, SC, SL	<b>US5033</b>
3.3L V6 3275cc	2000	SE, XE; To 12/1999	<b>US9338</b>	3.1L V6 189 CID	1997	SC, SL	<b>US5033</b>
3.3L V6 3275cc	2001-2004	SE, XE	<b>US9338</b>	3.1L V6 189 CID	1998	S	<b>US5033</b>
4.0L V6 3954cc	2005	Off-Road, S, SE	<b>US9426</b>	3.3L V6 204 CID	1992	S, SC, SL	<b>US5050</b>
4.0L V6 3954cc	2006	Off-Road, S, SE, X; From 09/2005	<b>US9426</b>	3.3L V6 204 CID	1993	S, SL	<b>US5050</b>
4.0L V6 3954cc	2006	Off-Road, S, SE, X; To 09/2005	<b>US9426</b>	<b>ALERO</b>			
4.0L V6 3954cc	2007-2010	Off-Road, S, SE, X	<b>US9426</b>	2.2L L4 2198cc 134 CID	2002-2003	GL, GLS, GX	<b>US5092</b>
4.0L V6 3954cc	2011-2015	PRO-4X, S, X	<b>US9426</b>	2.2L L4 2198cc 134 CID	2004	GL, GX	<b>US5092</b>
<b>X-TRAIL</b>				2.4L L4 2392cc 146 CID	1999-2001	GL, GLS, GX	<b>US5076</b>
2.5L L4 2488cc 152 CID	2002-2010		<b>US9427</b>	3.4L V6 207 CID	1999	GL, GLS	<b>US5033</b>
2.5L L4 2488cc 152 CID	2002-2010	Includes back housing	<b>US9427-2</b>	3.4L V6 207 CID	2000-2002	GL, GLS, GX	<b>US5033</b>
<b>OLDSMOBILE</b>				3.4L V6 207 CID	2003-2004	GL, GLS	<b>US5033</b>
<b>88</b>				<b>AURORA</b>			
3.8L V6 3800cc 231 CID	1992-1994	Royale, Royale LS	<b>US5050</b>	3.5L V6 214 CID	2001-2002	Base	<b>US5085</b>
3.8L V6 3800cc 231 CID	1995	Royale, Royale LS, Royale LSS	<b>US5050</b>	4.0L V8 244 CID	1995-1999	Base	<b>US5072</b>
3.8L V6 3800cc 231 CID	1996-1998	Royale, Royale LS	<b>US5075</b>	4.0L V8 244 CID	2001-2003	Base	<b>US5072</b>
3.8L V6 3800cc 231 CID	1999	50th Anniversary Edition, Royale, Royale LS	<b>US5075</b>	<b>BRAVADA</b>			
<b>98</b>				4.2L L6 256 CID	2002-2004	Base	<b>US5097</b>
3.0L V6 181 CID	1985	Regency	<b>US5028</b>	4.3L V6 262 CID	1991-1994	Base	<b>US5049</b>
3.8L V6 3800cc 231 CID	1985	Regency, Regency Brougham	<b>US5028</b>	4.3L V6 262 CID	1991-1994	Base; High performance	<b>US5049H</b>
3.8L V6 3800cc 231 CID	1986	Regency, Regency Brougham	<b>US5050</b>	4.3L V6 262 CID	1996-2001	Base	<b>US5077</b>
3.8L V6 3800cc 231 CID	1987	Regency, Regency Brougham, Regency Grande, Regency Touring	<b>US5050</b>	4.3L V6 262 CID	1996-2001	Base; High performance	<b>US5077H</b>
3.8L V6 3800cc 231 CID	1988-1990	Regency, Regency Brougham, Regency Touring	<b>US5050</b>	<b>CALAIS</b>			
3.8L V6 3800cc 231 CID	1991	Regency Elite, Touring	<b>US5050</b>	2.3L L4 138 CID	1987	Base, GT	<b>US5043</b>
3.8L V6 3800cc 231 CID	1992-1993	Regency, Regency Elite, Touring	<b>US5050</b>	2.5L L4 2474cc 151 CID	1985	500, Base, Supreme	<b>US5000</b>
3.8L V6 3800cc 231 CID	1994	Regency, Regency Elite	<b>US5050</b>	2.5L L4 2474cc 151 CID	1985-1987	With Multi-Groove pulley	<b>US5067</b>
3.8L V6 3800cc 231 CID	1995	Regency Elite	<b>US5050</b>	2.5L L4 2474cc 151 CID	1986	Base, ES, GT, Supreme	<b>US5000</b>
				2.5L L4 2474cc 151 CID	1987	Base, GT, Supreme	<b>US5000</b>
				3.0L V6 181 CID	1985	500, Base, Supreme	<b>US5050</b>

Engine	Years	Application Description	USMW	Engine	Years	Application Description	USMW
<b>OLDSMOBILE (cont'd.)</b>				<b>OLDSMOBILE (cont'd.)</b>			
<b>CALAIS (cont'd.)</b>				<b>CUTLASS CALAIS (cont'd.)</b>			
3.0L V6 181 CID	1986	Base, ES, GT, Supreme	US5050	3.8L V6 3800cc 231 CID	1980-1982	Base	US1018
3.0L V6 181 CID	1987	Base, GT, Supreme	US5050	3.8L V6 3800cc 231 CID	1980-1982	Base; High performance	US1018H
<b>CUSTOM CRUISER</b>				<b>CUTLASS CALAIS (cont'd.)</b>			
5.0L V8 305 CID	1991-1992	Base	US5051	3.8L V6 3800cc 231 CID	1983	Base, Hurst	US1018
5.0L V8 307 CID	1980-1985	Base; Exc.Air Cond	US1100	3.8L V6 3800cc 231 CID	1983	Base, Hurst; High performance	US1018H
5.0L V8 307 CID	1980-1985	Base; With air cond.	US1120	3.8L V6 3800cc 231 CID	1984	Base	US1018
5.0L V8 307 CID	1980-1985	Base; High performance, With air cond.	US1120H	3.8L V6 3800cc 231 CID	1984	Base; High performance	US1018H
5.0L V8 307 CID	1986-1990	Base	US1120	4.3L V6 260 CID	1982	Base	US5012
5.0L V8 307 CID	1986-1990	Base; High performance	US1120H	4.3L V6 260 CID	1983	Base, Hurst	US5012
5.7L V8 350 CID	1977-1979	Exc.Air Cond	US1100	4.3L V6 260 CID	1984	Base	US5012
5.7L V8 350 CID	1977-1979	Air Cond	US1120	4.3L V8 260 CID	1978-1979	Exc.Air Cond	US1100
5.7L V8 350 CID	1977-1979	Air Cond, High performance	US1120H	4.3L V8 260 CID	1978-1979	Air Cond	US1120
5.7L V8 350 CID	1980-1985	Base; Exc.Air Cond	US1100	4.3L V8 260 CID	1978-1979	Air Cond, High performance	US1120H
5.7L V8 350 CID	1980-1985	Base; With air cond.	US1120	4.3L V8 260 CID	1980	Base; With air cond.	US1120
5.7L V8 350 CID	1980-1985	Base; High performance, With air cond.	US1120H	4.3L V8 260 CID	1980	Base; High performance, With air cond.	US1120H
5.7L V8 350 CID	1992	Base	US5051	4.3L V8 260 CID	1980-1982	Base; Exc.Air Cond	US1100
6.6L V8 400 CID	1975		US975	4.3L V8 260 CID	1982	Base; With air cond.	US1120
6.6L V8 400 CID	1975	Exc.Air Cond	US1100	4.3L V8 260 CID	1982	Base; High performance, With air cond.	US1120H
6.6L V8 400 CID	1975	Air Cond	US1120	5.0L V8 305 CID	1980	Base	US1121
6.6L V8 400 CID	1975	Air Cond, High performance	US1120H	5.0L V8 305 CID	1980	Base; High performance	US1121H
6.6L V8 403 CID	1977-1979	Exc.Air Cond	US1100	5.0L V8 307 CID	1982	Base; Exc.Air Cond	US1100
6.6L V8 403 CID	1977-1979	Air Cond	US1120	5.0L V8 307 CID	1982	Base; With air cond.	US1120
6.6L V8 403 CID	1977-1979	Air Cond, High performance	US1120H	5.0L V8 307 CID	1982	Base; High performance, With air cond.	US1120H
6.6L V8 403 CID	1977-1979	Air Cond	US1120	5.0L V8 307 CID	1983-1984	Base, Hurst; Exc.Air Cond	US1100
6.6L V8 403 CID	1977-1979	Air Cond, High performance	US1120H	5.0L V8 307 CID	1983-1984	Base, Hurst; With air cond.	US1120
7.5L V8 455 CID	1975-1976	Exc.Air Cond	US1100	5.0L V8 307 CID	1983-1984	Base, Hurst; High performance, With air cond.	US1120H
7.5L V8 455 CID	1975-1976	Air Cond	US1120	5.7L V8 350 CID	1979	Exc.Air Cond	US1100
7.5L V8 455 CID	1975-1976	Air Cond, High performance	US1120H	5.7L V8 350 CID	1979	Air Cond	US1120
<b>CUTLASS</b>				<b>CUTLASS CALAIS (cont'd.)</b>			
3.1L V6 189 CID	1997-1998	Base, GLS	US5033	5.7L V8 350 CID	1979	Air Cond, High performance	US1120H
3.1L V6 189 CID	1999	GL, GLS	US5033	5.7L V8 350 CID	1980-1981	Base; Exc.Air Cond	US1100
3.8L V6 231 CID	1977		US1018	5.7L V8 350 CID	1980-1982	Base; With air cond.	US1120
3.8L V6 231 CID	1977	High performance	US1018H	5.7L V8 350 CID	1980-1982	Base; High performance, With air cond.	US1120H
3.8L V6 3800cc 231 CID	1980	Base, Brougham, LS	US1018	5.7L V8 350 CID	1982	Base; 5" Cast, Exc.Air Cond	US1100
3.8L V6 3800cc 231 CID	1980	Base, Brougham, LS; High performance	US1018H	5.7L V8 350 CID	1982	Base; Exc.5" Cast, Exc.Air Cond	US1120
3.8L V6 3800cc 231 CID	1981	Brougham, LS	US1018	5.7L V8 350 CID	1982	Base; Exc.5" Cast, Exc.Air Cond, High performance	US1120H
3.8L V6 3800cc 231 CID	1981	Brougham, LS; High performance	US1018H	5.7L V8 350 CID	1983	Base, Hurst	US1120
4.1L L6 250 CID	1975-1976		US1107	5.7L V8 350 CID	1983	Base, Hurst; High performance	US1120H
4.3L V8 260 CID	1975-1979	Exc.Air Cond	US1100	5.7L V8 350 CID	1984	Base	US1120
4.3L V8 260 CID	1975-1979	Air Cond	US1120	5.7L V8 350 CID	1984	Base; High performance	US1120H
4.3L V8 260 CID	1975-1979	Air Cond, High performance	US1120H	<b>CUTLASS CIERA</b>			
4.3L V8 260 CID	1980	Base, Brougham, LS; Exc.Air Cond	US1100	2.2L L4 2190cc 134 CID	1993	Base, S	US5032
4.3L V8 260 CID	1980	Base, Brougham, LS; With air cond.	US1120	2.2L L4 2190cc 134 CID	1994	S	US5032
4.3L V8 260 CID	1980	Base, Brougham, LS; High performance, With air cond.	US1120H	2.2L L4 2190cc 134 CID	1995-1996	Base	US5032
4.3L V8 260 CID	1981	Brougham, LS; Exc.Air Cond	US1100	2.5L L4 2474cc 151 CID	1982	Base, Brougham, LS	US5000
4.3L V8 260 CID	1981	Brougham, LS; With air cond.	US1120	2.5L L4 2474cc 151 CID	1982	Base, Brougham, LS; Includes pulley	US5000P
4.3L V8 260 CID	1981	Brougham, LS; High performance, With air cond.	US1120H	2.5L L4 2474cc 151 CID	1983	Base, Brougham, ES, LS	US5000
5.0L V8 305 CID	1980	Base, Brougham, LS	US1121	2.5L L4 2474cc 151 CID	1983	Base, Brougham, ES, LS; Includes pulley	US5000P
5.0L V8 305 CID	1980	Base, Brougham, LS; High performance	US1121H	2.5L L4 2474cc 151 CID	1984	Brougham, Cruiser LS, LS	US5000
5.7L V8 350 CID	1968-1970	With A/C	US926	2.5L L4 2474cc 151 CID	1984	Brougham, Cruiser LS, LS; Includes pulley	US5000P
5.7L V8 350 CID	1975-1979	Exc.Air Cond	US1100	2.5L L4 2474cc 151 CID	1985	Brougham, Cruiser LS, ES, Holiday, LS	US5000
5.7L V8 350 CID	1975-1979	Air Cond	US1120	2.5L L4 2474cc 151 CID	1985	Brougham, Cruiser LS, ES, Holiday, LS; Includes pulley	US5000P
5.7L V8 350 CID	1975-1979	Air Cond, High performance	US1120H	2.5L L4 2474cc 151 CID	1985	Brougham, Cruiser LS, ES, Holiday, LS; Includes pulley	US5000P
5.7L V8 350 CID	1980	Base, Brougham, LS; Exc.Air Cond	US1100	2.5L L4 2474cc 151 CID	1985-1987	With Multi-Groove pulley	US5067
5.7L V8 350 CID	1980	Base, Brougham, LS; With air cond.	US1120	2.5L L4 2474cc 151 CID	1986	Brougham, ES, GT, Holiday, LS, S, SL	US5000
5.7L V8 350 CID	1980	Base, Brougham, LS; High performance, With air cond.	US1120H	2.5L L4 2474cc 151 CID	1986	Brougham, ES, GT, Holiday, LS, S, SL; Includes pulley	US5000P
5.7L V8 350 CID	1980	Brougham, LS; Exc.Air Cond	US1100	2.5L L4 2474cc 151 CID	1987	Brougham, GT, LS, S, SL	US5041
5.7L V8 350 CID	1981	Brougham, LS; With air cond.	US1120	2.5L L4 2474cc 151 CID	1987	Brougham, GT, LS, S, SL	US5041
5.7L V8 350 CID	1981	Brougham, LS; High performance, With air cond.	US1120H	2.5L L4 2474cc 151 CID	1988	Base, Brougham, LS, S, SL	US5041
6.6L V8 403 CID	1977	Exc.Air Cond	US1100	2.5L L4 2474cc 151 CID	1988	Base, Brougham, LS, S, SL	US5041
6.6L V8 403 CID	1977	Air Cond	US1120	2.5L L4 2474cc 151 CID	1989	Base, SL	US5041
6.6L V8 403 CID	1977	Air Cond, High performance	US1120H	2.5L L4 2474cc 151 CID	1989	Base, SL	US5041
7.5L V8 455 CID	1970	With A/C	US926	2.5L L4 2474cc 151 CID	1991	Base, S	US5041
7.5L V8 455 CID	1975-1976	Exc.Air Cond	US1100	2.5L L4 2474cc 151 CID	1992	Base	US5041
7.5L V8 455 CID	1975-1976	Air Cond	US1120	2.5L L4 2474cc 151 CID	1992	Base	US5041
7.5L V8 455 CID	1975-1976	Air Cond, High performance	US1120H	2.8L V6 173 CID	1986	Brougham, ES, GT, Holiday, LS, S, SL	US5001
<b>CUTLASS CALAIS</b>				2.8L V6 173 CID	1987	Brougham, GT, LS, S, SL	US5033
2.3L L4 138 CID	1988	Base, GT, International, SL	US5043	2.8L V6 173 CID	1988	Base, Brougham, LS, S, SL	US5033
2.3L L4 138 CID	1989-1990	International, S, SL	US5043	2.8L V6 173 CID	1989	Base, SL	US5028
2.3L L4 138 CID	1991	Base, GT, International, S, SL	US5043	3.0L V6 181 CID	1982	Base, Brougham, LS	US5028
2.3L L4 140 CID	1989	International	US5043	3.0L V6 181 CID	1983	Base, Brougham, ES, LS	US5028
2.3L L4 140 CID	1990-1991	International, S	US5043	3.0L V6 181 CID	1984	Brougham, Cruiser LS, LS	US5028
2.5L L4 2474cc 151 CID	1988	Base, GT, SL	US5000	3.0L V6 181 CID	1985	Brougham, Cruiser LS, ES, Holiday, LS	US5028
2.5L L4 2474cc 151 CID	1989	Base, GT, S, SL	US5000	3.1L V6 189 CID	1994	S, SL	US5033
2.5L L4 2474cc 151 CID	1990-1991	Base, GT, S	US5000	3.1L V6 189 CID	1995-1996	Base	US5033
3.0L V6 181 CID	1988	Base, GT, SL	US5050	3.3L V6 204 CID	1989	Base, GT, SL	US5050
3.3L V6 204 CID	1989	S, SL	US5050	3.3L V6 204 CID	1990	Base, GT, S, SL	US5050
3.3L V6 204 CID	1990-1991	SL	US5050	3.3L V6 204 CID	1991-1993	Base, S, SL	US5050
3.8L V6 231 CID	1979		US1018	3.8L V6 3800cc 231 CID	1984	Brougham, LS	US5028
3.8L V6 231 CID	1979	High performance	US1018H	3.8L V6 3800cc 231 CID	1985	Brougham, Cruiser LS, ES, GT, Holiday, LS	US5028
3.8L V6 3800cc 231 CID	1978-1979		US1018	3.8L V6 3800cc 231 CID	1986	ES, GT, Holiday, LS, S, SL	US5050
3.8L V6 3800cc 231 CID	1978-1979	High performance	US1018H	3.8L V6 3800cc 231 CID	1987	Brougham, GT, LS, S, SL	US5050
				3.8L V6 3800cc 231 CID	1988	Base, Brougham, International, LS, S, SL	US5050
				4.3L V6 260 CID	1982	Base, Brougham, LS; W/O Pulley	US5014
				4.3L V6 260 CID	1982	Base, Brougham, LS; Includes pulley	US5014P

WATER PUMPS



Engine	Years	Application Description	USMW	Engine	Years	Application Description	USMW
<b>OLDSMOBILE (cont'd.)</b>				<b>OLDSMOBILE (cont'd.)</b>			
<b>CUTLASS CIERA (cont'd.)</b>				<b>CUTLASS SALON (cont'd.)</b>			
4.3L V6 260 CID	1983	Brougham, LS; W/O Pulley	US5014	7.5L V8 455 CID	1975-1976	Exc.Air Cond	US1100
4.3L V6 260 CID	1983	Brougham, LS; Includes pulley	US5014P	7.5L V8 455 CID	1975-1976	Air Cond	US1120
4.3L V6 260 CID	1984-1985	Brougham, Cruiser LS, LS; W/O Pulley	US5014	7.5L V8 455 CID	1975-1976	Air Cond, High performance	US1120H
4.3L V6 260 CID	1984-1985	Brougham, Cruiser LS, LS; Includes pulley	US5014P	<b>CUTLASS SUPREME</b>			
<b>CUTLASS CRUISER</b>				2.3L L4 138 CID	1990-1991	Base	US5043
2.5L L4 2474cc 151 CID	1987	Brougham, LS	US5041	2.3L L4 140 CID	1990	Base, International	US5043
2.5L L4 2474cc 151 CID	1987	With Multi-Groove pulley	US5067	2.8L V6 173 CID	1988	Base, Indy 500 Pace Car, International, SL	US5033
2.5L L4 2474cc 151 CID	1988	Brougham LS, LS, SL	US5041	2.8L V6 173 CID	1989	Base, International, SL	US5033
2.5L L4 2474cc 151 CID	1989	Base, SL	US5041	3.1L V6 189 CID	1989-1991	Base, International, SL	US5033
2.5L L4 2474cc 151 CID	1990	Base	US5041	3.1L V6 189 CID	1992-1993	Base, International, S	US5033
2.8L V6 173 CID	1987	Brougham, LS	US5033	3.1L V6 189 CID	1994	Base, S	US5033
2.8L V6 173 CID	1988	Brougham LS, LS, SL	US5033	3.1L V6 189 CID	1995-1997	Base, SL	US5033
2.8L V6 173 CID	1989	Base, SL	US5033	3.4L V6 207 CID	1991	Base, International, SL	US5033
3.1L V6 189 CID	1994	Base, S, Special Edition	US5033	3.4L V6 207 CID	1992	International, S	US5033
3.3L V6 204 CID	1989-1990	Base, SL	US5050	3.4L V6 207 CID	1993	Base, International, S	US5033
3.3L V6 204 CID	1991-1992	S, SL	US5050	3.4L V6 207 CID	1994	Base, S	US5033
3.3L V6 204 CID	1993	Base, S	US5050	3.4L V6 207 CID	1995-1996	Base, SL	US5033
3.8L V6 3800cc 231 CID	1980-1981	Base, Brougham	US1018	3.8L V6 3800cc 231 CID	1980	Base, Brougham	US1018
3.8L V6 3800cc 231 CID	1980-1981	Base, Brougham; High performance	US1018H	3.8L V6 3800cc 231 CID	1980	Base, Brougham; High performance	US1018H
3.8L V6 3800cc 231 CID	1982	Base	US1018	3.8L V6 3800cc 231 CID	1981	Base, Brougham, LS	US1018
3.8L V6 3800cc 231 CID	1982	Base; High performance	US1018H	3.8L V6 3800cc 231 CID	1981	Base, Brougham, LS; High performance	US1018H
3.8L V6 3800cc 231 CID	1987	Brougham, LS	US5050	3.8L V6 3800cc 231 CID	1982	Base, Brougham	US1018
3.8L V6 3800cc 231 CID	1988	Brougham LS, LS, SL	US5050	3.8L V6 3800cc 231 CID	1982	Base, Brougham; High performance	US1018H
4.3L V8 260 CID	1980-1981	Base, Brougham; Exc.Air Cond	US1100	3.8L V6 3800cc 231 CID	1982	Base, Brougham; High performance	US1018H
4.3L V8 260 CID	1982	Base	US1100	3.8L V6 3800cc 231 CID	1983	Brougham	US1018
5.0L V8 305 CID	1980	Base, Brougham	US1121	3.8L V6 3800cc 231 CID	1983	Brougham; High performance	US1018H
5.0L V8 305 CID	1980	Base, Brougham; High performance	US1121H	3.8L V6 3800cc 231 CID	1984	Base, Brougham	US1018
5.0L V8 305 CID	1982	Base; For A/C Belt	US1121	3.8L V6 3800cc 231 CID	1984	Base, Brougham; High performance	US1018H
5.0L V8 305 CID	1982	Base; For A/C Belt, High performance	US1121H	3.8L V6 3800cc 231 CID	1985	Base, Brougham, LS	US1018
5.0L V8 307 CID	1981	Base, Brougham; Exc.Air Cond	US1100	3.8L V6 3800cc 231 CID	1985	Base, Brougham, LS; High performance	US1018H
5.0L V8 307 CID	1982-1983	Base; Exc.Air Cond	US1100	3.8L V6 3800cc 231 CID	1986	Base, Brougham	US1018
5.0L V8 307 CID	1982-1983	Base; With air cond.	US1120	3.8L V6 3800cc 231 CID	1986	Base, Brougham; High performance	US1018H
5.0L V8 307 CID	1982-1983	Base; High performance, With air cond.	US1120H	3.8L V6 3800cc 231 CID	1987	442, Base, Brougham	US1018
5.7L V8 350 CID	1980	Base, Brougham; With air cond.	US1120	3.8L V6 3800cc 231 CID	1987	442, Base, Brougham; High performance	US1018H
5.7L V8 350 CID	1980	Base, Brougham; High performance, With air cond.	US1120H	4.3L V6 260 CID	1982-1983	Base, Brougham	US1120
5.7L V8 350 CID	1980-1981	Base, Brougham; 5" Cast, Exc.Air Cond	US1100	4.3L V6 260 CID	1982-1983	Base, Brougham; High performance	US1120H
5.7L V8 350 CID	1981	Brougham; With air cond.	US1120	4.3L V6 260 CID	1984	Base, Brougham	US5012
5.7L V8 350 CID	1981	Brougham; High performance, With air cond.	US1120H	4.3L V8 260 CID	1980	Base, Brougham; Exc.Air Cond	US1100
5.7L V8 350 CID	1982	Base; Exc. air cond.	US1120	4.3L V8 260 CID	1981	Base, Brougham, LS; Exc.Air Cond	US1100
5.7L V8 350 CID	1982	Base; Exc. air cond., High performance	US1120H	4.3L V8 260 CID	1982	Base, Brougham	US1100
5.7L V8 350 CID	1982-1983	Base; With air cond.	US1120	5.0L V8 305 CID	1980	Base, Brougham	US1121
5.7L V8 350 CID	1982-1983	Base; High performance, With air cond.	US1120H	5.0L V8 305 CID	1980	Base, Brougham; High performance	US1121H
5.7L V8 350 CID	1983	Base; Exc.Air Cond	US1100	5.0L V8 307 CID	1982-1984	Base, Brougham; Exc.Air Cond	US1100
<b>CUTLASS SALON</b>				5.0L V8 307 CID	1982-1984	Base, Brougham; With air cond.	US1120
3.8L V6 231 CID	1979		US1018	5.0L V8 307 CID	1982-1984	Base, Brougham; High performance, With air cond.	US1120H
3.8L V6 231 CID	1979	High performance	US1018H	5.0L V8 307 CID	1985	Base, Brougham, LS; Exc. air cond.	US1120
3.8L V6 3800cc 231 CID	1978-1979		US1018	5.0L V8 307 CID	1985	Base, Brougham, LS; With air cond.	US1120
3.8L V6 3800cc 231 CID	1978-1979	High performance	US1018H	5.0L V8 307 CID	1985	Base, Brougham, LS; Exc. air cond., High performance	US1120H
3.8L V6 3800cc 231 CID	1980	Base, Brougham	US1018	5.0L V8 307 CID	1985	Base, Brougham, LS; High performance, With air cond.	US1120H
3.8L V6 3800cc 231 CID	1980	Base, Brougham; High performance	US1018H	5.0L V8 307 CID	1986	Base, Brougham	US1120
3.8L V6 3800cc 231 CID	1985-1987	Base	US1018	5.0L V8 307 CID	1986	Base, Brougham; High performance	US1120H
3.8L V6 3800cc 231 CID	1985-1987	Base; High performance	US1018H	5.0L V8 307 CID	1987	442, Base, Brougham	US1120
4.3L V8 260 CID	1975-1979	Exc.Air Cond	US1100	5.0L V8 307 CID	1987	442, Base, Brougham; High performance	US1120H
4.3L V8 260 CID	1975-1979	Air Cond	US1120	5.0L V8 307 CID	1987	442, Base, Brougham; High performance	US1120H
4.3L V8 260 CID	1975-1979	Air Cond, High performance	US1120H	5.0L V8 307 CID	1988	Classic, Classic Brougham	US1120
4.3L V8 260 CID	1980	Base, Brougham; Exc.Air Cond	US1100	5.0L V8 307 CID	1988	Classic, Classic Brougham; High performance	US1120H
4.3L V8 260 CID	1980	Base, Brougham; With air cond.	US1120	5.0L V8 307 CID	1988	Base, Brougham; Exc.Air Cond	US1100
4.3L V8 260 CID	1980	Base, Brougham; High performance, With air cond.	US1120H	5.7L V8 350 CID	1980	Base, Brougham; With air cond.	US1120
4.3L V8 260 CID	1980	Base, Brougham	US1121	5.7L V8 350 CID	1980	Base, Brougham; High performance, With air cond.	US1120H
5.0L V8 305 CID	1980	Base, Brougham; High performance	US1121H	5.7L V8 350 CID	1981	Base, Brougham, LS; Exc.Air Cond	US1100
5.0L V8 307 CID	1985-1986	442, Base; Exc.Air Cond	US1100	5.7L V8 350 CID	1981	Base, Brougham, LS; With air cond.	US1120
5.0L V8 307 CID	1985-1986	442, Base; With air cond.	US1120	5.7L V8 350 CID	1981	Base, Brougham, LS; High performance, With air cond.	US1120H
5.0L V8 307 CID	1985-1986	442, Base; High performance, With air cond.	US1120H	5.7L V8 350 CID	1981	Base, Brougham; Exc. air cond.	US1120
5.0L V8 307 CID	1987	Base	US1120	5.7L V8 350 CID	1982	Base, Brougham; Exc. air cond., High performance	US1120H
5.0L V8 307 CID	1987	Base; High performance	US1120H	5.7L V8 350 CID	1982	Base, Brougham; Exc. air cond., High performance	US1120H
5.7L V8 350 CID	1975-1977	Exc.Air Cond	US1100	5.7L V8 350 CID	1982-1984	Base, Brougham; With air cond.	US1120
5.7L V8 350 CID	1975-1977	Air Cond	US1120	5.7L V8 350 CID	1982-1984	Base, Brougham; High performance, With air cond.	US1120H
5.7L V8 350 CID	1975-1977	Air Cond, High performance	US1120H	5.7L V8 350 CID	1982-1984	Base, Brougham; High performance, With air cond.	US1120H
5.7L V8 350 CID	1979	Exc.Air Cond	US1100	5.7L V8 350 CID	1983-1984	Base, Brougham; Exc.Air Cond	US1100
5.7L V8 350 CID	1979	Air Cond	US1120	5.7L V8 350 CID	1985	Base, Brougham, LS	US1120
5.7L V8 350 CID	1979	Air Cond, High performance	US1120H	5.7L V8 350 CID	1985	Base, Brougham, LS; High performance	US1120H
5.7L V8 350 CID	1979	Base, Brougham; Exc.Air Cond	US1100	<b>CUTLASS TIARA</b>			
5.7L V8 350 CID	1980	Base, Brougham; With air cond.	US1120	4.3L V8 260 CID	1976	Exc.Air Cond	US1100
5.7L V8 350 CID	1980	Base, Brougham; High performance, With air cond.	US1120H	4.3L V8 260 CID	1976	Air Cond	US1120
5.7L V8 350 CID	1985	Base	US1120	4.3L V8 260 CID	1976	Air Cond, High performance	US1120H
5.7L V8 350 CID	1985	Base; High performance	US1120H	5.7L V8 350 CID	1976	Exc.Air Cond	US1100
6.6L V8 403 CID	1977	Exc.Air Cond	US1100	5.7L V8 350 CID	1976	Air Cond	US1120
6.6L V8 403 CID	1977	Air Cond	US1120	5.7L V8 350 CID	1976	Air Cond, High performance	US1120H
6.6L V8 403 CID	1977	Air Cond, High performance	US1120H				



Engine	Years	Application Description	USMW	Engine	Years	Application Description	USMW
<b>OLDSMOBILE (cont'd.)</b>				<b>OLDSMOBILE (cont'd.)</b>			
<b>CUTLASS TIARA (cont'd.)</b>				<b>DELTA 88 (cont'd.)</b>			
7.5L V8 455 CID	1976	Exc.Air Cond	US1100	6.6L V8 403 CID	1977-1979	Air Cond	US1120
7.5L V8 455 CID	1976	Air Cond	US1120	6.6L V8 403 CID	1977-1979	Air Cond, High performance	US1120H
7.5L V8 455 CID	1976	Air Cond, High performance	US1120H	7.0L V8 6966cc 425 CID	1965-1967	Without A/C	US773
<b>DELMONT 88</b>				<b>F85</b>			
5.7L V8 350 CID	1968	With A/C	US926	5.7L V8 350 CID	1968-1970	With A/C	US926
7.5L V8 455 CID	1968	With A/C	US926	7.5L V8 455 CID	1970	With A/C	US926
<b>DELTA 88</b>				<b>FIRENZA</b>			
3.0L V6 181 CID	1986	Royale, Royale Brougham	US5050	1.8L L4 112 CID	1982	LX, S, SX	US5007
3.8L V6 231 CID	1977		US1018	1.8L L4 112 CID	1982	LX, SX	US5017
3.8L V6 231 CID	1977	High performance	US1018H	1.8L L4 112 CID	1983	Cruiser LX, Cruiser S, Cruiser SX, LX, S, SX	US5017
3.8L V6 3800cc 231 CID	1977-1979		US1018	1.8L L4 112 CID	1984	Base, Brougham LX, Brougham SX, Cruiser, Cruiser LX, Cruiser SX, ES, GT, S	US5017
3.8L V6 3800cc 231 CID	1977-1979	High performance	US1018H	1.8L L4 112 CID	1985	Base, Brougham LX, Brougham SX, Cruiser LX, Cruiser SX, ES, GT	US5017
3.8L V6 3800cc 231 CID	1980-1981	Base, Holiday, Royale, Royale Brougham	US1018	1.8L L4 112 CID	1986	Base, Cruiser, Cruiser LX, LC, LX, S	US5017
3.8L V6 3800cc 231 CID	1980-1981	Base, Holiday, Royale, Royale Brougham; High performance	US1018H	2.0L L4 122 CID	1983	Cruiser LX, Cruiser S, Cruiser SX, LX, S, SX	US5007
3.8L V6 3800cc 231 CID	1982-1983	Base, Royale, Royale Brougham	US1018	2.0L L4 122 CID	1984	Base, Brougham LX, Brougham SX, Cruiser, Cruiser LX, Cruiser SX, ES, GT, S	US5007
3.8L V6 3800cc 231 CID	1982-1983	Base, Royale, Royale Brougham; High performance	US1018H	2.0L L4 122 CID	1985	Base, Brougham LX, Brougham SX, Cruiser LX, Cruiser SX, ES, GT	US5007
3.8L V6 3800cc 231 CID	1984	Royale, Royale Brougham, Royale Brougham LS	US1018	2.0L L4 122 CID	1986	Base, Cruiser, Cruiser LX, LC, LX, S	US5007
3.8L V6 3800cc 231 CID	1984	Royale, Royale Brougham, Royale Brougham LS; High performance	US1018H	2.0L L4 122 CID	1987	Base, Cruiser, LC, LX, S	US5032
3.8L V6 3800cc 231 CID	1985	Royale, Royale Brougham	US1018	2.0L L4 122 CID	1987	Base, Cruiser, LC, LX, S	US5036
3.8L V6 3800cc 231 CID	1985	Royale, Royale Brougham; High performance	US1018H	2.0L L4 122 CID	1988	Base, Cruiser	US5032
3.8L V6 3800cc 231 CID	1986-1991	Royale, Royale Brougham	US5050	2.0L L4 122 CID	1988	Base, Cruiser	US5036
4.3L V8 260 CID	1977-1979	Exc.Air Cond	US1100	2.0L L4 122 CID	1985	Base, Brougham LX, Brougham SX, Cruiser LX, Cruiser SX, ES, GT	US5020
4.3L V8 260 CID	1977-1979	Air Cond	US1120	2.8L V6 173 CID	1986	GT	US5020
4.3L V8 260 CID	1977-1979	Air Cond, High performance	US1120H	2.8L V6 173 CID	1987	GT	US5033
4.3L V8 260 CID	1980-1981	Base, Holiday, Royale, Royale Brougham; Exc.Air Cond	US1100	<b>INTRIGUE</b>			
4.3L V8 260 CID	1980-1981	Base, Holiday, Royale, Royale Brougham; With air cond.	US1120	3.5L V6 214 CID	1999-2002	GL, GLS, GX	US5085
4.3L V8 260 CID	1980-1981	Base, Holiday, Royale, Royale Brougham; High performance, With air cond.	US1120H	3.8L V6 3800cc 231 CID	1998	Base, GL, GLS	US5075
4.3L V8 260 CID	1982	Base, Royale, Royale Brougham; Exc.Air Cond	US1100	3.8L V6 3800cc 231 CID	1999	GL, GX	US5075
4.3L V8 260 CID	1982	Base, Royale, Royale Brougham; With air cond.	US1120	<b>LSS</b>			
4.3L V8 260 CID	1982	Base, Royale, Royale Brougham; High performance, With air cond.	US1120H	3.8L V6 3800cc 231 CID	1996-1999	Base	US5075
4.9L V8 301 CID	1979		US975	<b>OMEGA</b>			
5.0L V8 307 CID	1980-1981	Base, Holiday, Royale, Royale Brougham; Exc.Air Cond	US1100	2.5L L4 2474cc 151 CID	1980	Base, Brougham, SX	US5000
5.0L V8 307 CID	1980-1981	Base, Holiday, Royale, Royale Brougham; With air cond.	US1120	2.5L L4 2474cc 151 CID	1980	Base, Brougham, SX; Includes pulley	US5000P
5.0L V8 307 CID	1980-1981	Base, Holiday, Royale, Royale Brougham; High performance, With air cond.	US1120H	2.5L L4 2474cc 151 CID	1981	Base, Brougham, ES, Sport, SX	US5000
5.0L V8 307 CID	1982-1983	Base, Royale, Royale Brougham; Exc.Air Cond	US1100	2.5L L4 2474cc 151 CID	1981	Base, Brougham, ES, Sport, SX; Includes pulley	US5000P
5.0L V8 307 CID	1982-1983	Base, Royale, Royale Brougham; With air cond.	US1120	2.5L L4 2474cc 151 CID	1982	Base, Brougham, ES	US5000
5.0L V8 307 CID	1982-1983	Base, Royale, Royale Brougham; High performance, With air cond.	US1120H	2.5L L4 2474cc 151 CID	1982	Base, Brougham, ES; Includes pulley	US5000P
5.0L V8 307 CID	1982-1983	Royale, Royale Brougham, Royale Brougham LS; Exc.Air Cond	US1100	2.5L L4 2474cc 151 CID	1983	Base, Brougham, ES, ESC	US5000
5.0L V8 307 CID	1984-1985	Royale, Royale Brougham, Royale Brougham LS; With air cond.	US1120	2.5L L4 2474cc 151 CID	1983	Base, Brougham, ES, ESC; Includes pulley	US5000P
5.0L V8 307 CID	1984-1985	Royale, Royale Brougham, Royale Brougham LS; High performance, With air cond.	US1120H	2.5L L4 2474cc 151 CID	1984	Base, Brougham, ES	US5000
5.7L V8 350 CID	1968-1970	With A/C	US926	2.5L L4 2474cc 151 CID	1984	Base, Brougham, ES; Includes pulley	US5000P
5.7L V8 350 CID	1975-1979	Exc.Air Cond	US1100	2.8L V6 173 CID	1980	Base, Brougham, SX	US5001
5.7L V8 350 CID	1975-1979	Air Cond	US1120	2.8L V6 173 CID	1981	Base, Brougham, ES, Sport, SX	US5001
5.7L V8 350 CID	1975-1979	Air Cond, High performance	US1120H	2.8L V6 173 CID	1982	Base, Brougham, ES	US5001
5.7L V8 350 CID	1980-1981	Base, Holiday, Royale, Royale Brougham; Exc.Air Cond	US1100	2.8L V6 173 CID	1983	Base, Brougham, ES, ESC	US5001
5.7L V8 350 CID	1980-1981	Base, Holiday, Royale, Royale Brougham; With air cond.	US1120	2.8L V6 173 CID	1984	Base, Brougham, ES	US5001
5.7L V8 350 CID	1980-1981	Base, Holiday, Royale, Royale Brougham; High performance, With air cond.	US1120H	2.8L V6 173 CID	1984	Base, Brougham, ES	US5001
5.7L V8 350 CID	1982-1983	Base, Royale, Royale Brougham; Exc.Air Cond	US1100	3.8L V6 231 CID	1977	Brougham; (Z)	US1018
5.7L V8 350 CID	1982-1983	Base, Royale, Royale Brougham; With air cond.	US1120	3.8L V6 231 CID	1977	High performance	US1018H
5.7L V8 350 CID	1982-1983	Base, Royale, Royale Brougham; High performance, With air cond.	US1120H	3.8L V6 3800cc 231 CID	1978-1979		US1018
5.7L V8 350 CID	1984-1985	Royale, Royale Brougham, Royale Brougham LS; Exc.Air Cond	US1100	3.8L V6 3800cc 231 CID	1978-1979	High performance	US1018H
5.7L V8 350 CID	1984-1985	Royale, Royale Brougham, Royale Brougham LS; With air cond.	US1120	4.1L L6 250 CID	1974	With A/C	US927
5.7L V8 350 CID	1984-1985	Royale, Royale Brougham, Royale Brougham LS; High performance, With air cond.	US1120H	4.1L L6 250 CID	1975-1976		US1107
6.6L V8 400 CID	1975	Exc.Air Cond	US1100	4.3L V8 260 CID	1975-1977	Exc.Air Cond	US1100
6.6L V8 400 CID	1975	Air Cond	US1120	4.3L V8 260 CID	1975-1977	Air Cond	US1120
6.6L V8 400 CID	1975	Air Cond, High performance	US1120H	4.3L V8 260 CID	1975-1977	Air Cond, High performance	US1120H
6.6L V8 403 CID	1977-1979	Exc.Air Cond	US1100	5.7L V8 350 CID	1975-1979	Exc.Air Cond	US1100
				5.7L V8 350 CID	1975-1979	Air Cond	US1120
				5.7L V8 350 CID	1975-1979	Air Cond, High performance	US1120H
				<b>REGENCY</b>			
				3.8L V6 3800cc 231 CID	1997-1998	Base	US5075
				<b>SILHOUETTE</b>			
				3.1L V6 189 CID	1990-1994	Base	US5033
				3.4L V6 207 CID	1996	Base	US5033
				3.4L V6 207 CID	1997	Base, GL, GLS	US5033
				3.4L V6 207 CID	1998-1999	GL, GLS, GS, Premiere	US5033
				3.4L V6 207 CID	2000-2004	GL, GLS, Premiere	US5033
				3.8L V6 3800cc 231 CID	1992-1995	Base	US5050

WATER PUMPS

Engine	Years	Application Description	USMW	Engine	Years	Application Description	USMW
<b>OLDSMOBILE (cont'd.)</b>				<b>PLYMOUTH (cont'd.)</b>			
<b>STARFIRE</b>				<b>ACCLAIM (cont'd.)</b>			
2.5L L4 2474cc 151 CID	1978-1979		<b>US1107</b>	3.0L V6 2972cc 181 CID	1992-1995	Base	<b>US7121</b>
2.5L L4 2474cc 151 CID	1980	Base, Firenze, GT, SX	<b>US1107</b>	3.0L V6 2972cc 181 CID	1992-1995	Base; With back plate housing	<b>US7121-2</b>
3.8L V6 231 CID	1975-1976		<b>US1018</b>	<b>ARROW</b>			
3.8L V6 231 CID	1975-1976	High performance	<b>US1018H</b>	1.6L L4 1597cc 98 CID	1976-1977		<b>US1012</b>
3.8L V6 3800cc 231 CID	1977-1979		<b>US1018</b>	1.6L L4 1597cc 98 CID	1978-1979		<b>US7105</b>
3.8L V6 3800cc 231 CID	1977-1979	High performance	<b>US1018H</b>	1.6L L4 1597cc 98 CID	1980	Base, GS, GT	<b>US7105</b>
3.8L V6 3800cc 231 CID	1980	Base, Firenze, GT, SX	<b>US1018</b>	2.0L L4 1997cc 122 CID	1976-1978		<b>US7120</b>
3.8L V6 3800cc 231 CID	1980	Base, Firenze, GT, SX; High performance	<b>US1018H</b>	2.6L L4 2555cc 156 CID	1979		<b>US7120</b>
5.0L V8 305 CID	1977-1979		<b>US1069</b>	2.6L L4 2555cc 156 CID	1980	Base, GS, GT	<b>US7120</b>
<b>TORONADO</b>				<b>ARROW PICKUP</b>			
3.8L V6 3800cc 231 CID	1986	Brougham	<b>US5050</b>	2.0L L4 1997cc 122 CID	1979		<b>US7120</b>
3.8L V6 3800cc 231 CID	1987	Brougham, Trofeo	<b>US5050</b>	2.0L L4 1997cc 122 CID	1980-1982	Base, Sport	<b>US7120</b>
3.8L V6 3800cc 231 CID	1988-1992	Base, Trofeo	<b>US5050</b>	2.6L L4 2555cc 156 CID	1979		<b>US7120</b>
4.1L V6 252 CID	1981-1984	Brougham	<b>US1018</b>	2.6L L4 2555cc 156 CID	1980-1982	Base, Sport	<b>US7120</b>
4.1L V6 252 CID	1981-1984	Brougham; High performance	<b>US1018H</b>	<b>BARRACUDA</b>			
5.0L V8 307 CID	1980-1981	Brougham, XSC; Exc.Air Cond	<b>US1100</b>	4.5L V8 4473cc 273 CID	1964-1968		<b>US919</b>
5.0L V8 307 CID	1980-1981	Brougham, XSC; With air cond.	<b>US1120</b>	5.2L V8 318 CID	1968-1969		<b>US919</b>
5.0L V8 307 CID	1980-1981	Brougham, XSC; High performance, With air cond.	<b>US1120H</b>	5.2L V8 5200cc 318 CID	1967-1969	Mexican Application	<b>US907</b>
5.0L V8 307 CID	1982-1984	Brougham	<b>US1120</b>	5.2L V8 5212cc 318 CID	1966-1969		<b>US919</b>
5.0L V8 307 CID	1982-1984	Brougham; High performance	<b>US1120H</b>	5.6L V8 340 CID	1968-1969		<b>US919</b>
5.0L V8 307 CID	1985	Brougham, Caliente	<b>US1120</b>	5.6L V8 5572cc 340 CID	1968-1969		<b>US919</b>
5.0L V8 307 CID	1985	Brougham, Caliente; High performance	<b>US1120H</b>	<b>BELVEDERE</b>			
5.7L V8 350 CID	1979	Exc.Air Cond	<b>US1100</b>	3.8L L6 3770cc 230 CID	1955-1956		<b>US713</b>
5.7L V8 350 CID	1979	Air Cond	<b>US1120</b>	4.5L V8 273 CID	1968		<b>US919</b>
5.7L V8 350 CID	1979	Air Cond, High performance	<b>US1120H</b>	4.5L V8 4473cc 273 CID	1964-1968		<b>US919</b>
5.7L V8 350 CID	1980-1981	Brougham, XSC; Exc.Air Cond	<b>US1100</b>	5.2L V8 317 CID	1958-1959		<b>US919</b>
5.7L V8 350 CID	1980-1981	Brougham, XSC; With air cond.	<b>US1120</b>	5.2L V8 318 CID	1968-1969		<b>US919</b>
5.7L V8 350 CID	1980-1981	Brougham, XSC; High performance, With air cond.	<b>US1120H</b>	5.2L V8 5212cc 318 CID	1958-1969		<b>US919</b>
5.7L V8 350 CID	1982-1984	Brougham	<b>US1120</b>	<b>BELVEDERE II</b>			
5.7L V8 350 CID	1982-1984	Brougham; High performance	<b>US1120H</b>	4.5L V8 273 CID	1965-1967		<b>US919</b>
5.7L V8 350 CID	1985	Brougham, Caliente	<b>US1120</b>	5.2L V8 318 CID	1965-1967		<b>US919</b>
5.7L V8 350 CID	1985	Brougham, Caliente; High performance	<b>US1120H</b>	<b>BREEZE</b>			
6.6L V8 403 CID	1977-1978	Exc.Air Cond	<b>US1100</b>	2.0L L4 1996cc 122 CID	1996-1997	Base	<b>US7150</b>
6.6L V8 403 CID	1977-1978	Air Cond	<b>US1120</b>	2.0L L4 1996cc 122 CID	1998-1999	Base, Espresso	<b>US7150</b>
6.6L V8 403 CID	1977-1978	Air Cond, High performance	<b>US1120H</b>	2.0L L4 1996cc 122 CID	2000	Base	<b>US7150</b>
7.5L V8 455 CID	1975-1976	Exc.Air Cond	<b>US1100</b>	2.4L L4 2429cc 148 CID	1997	Base	<b>US7156</b>
7.5L V8 455 CID	1975-1976	Air Cond	<b>US1120</b>	2.4L L4 2429cc 148 CID	1998-1999	Base, Espresso	<b>US7156</b>
7.5L V8 455 CID	1975-1976	Air Cond, High performance	<b>US1120H</b>	2.4L L4 2429cc 148 CID	2000	Base	<b>US7156</b>
<b>VISTA CRUISER</b>				<b>CARAVELLE</b>			
5.7L V8 350 CID	1968-1970	With A/C	<b>US926</b>	2.2L L4 135 CID	1985	SE	<b>US7110</b>
7.5L V8 455 CID	1970	With A/C	<b>US926</b>	2.2L L4 135 CID	1985	SE; High performance	<b>US7110H</b>
<b>PEUGEOT</b>				2.2L L4 135 CID	1986-1988	Base, SE	<b>US7110</b>
<b>206</b>				2.2L L4 135 CID	1986-1988	Base, SE; High performance	<b>US7110H</b>
1.4L L4 1360cc 83 CID	2000-2004		<b>US8936</b>	2.5L L4 2507cc 153 CID	1986-1988	Base, SE	<b>US7110</b>
1.4L L4 1360cc 83 CID	2006-2008		<b>US8936</b>	2.5L L4 2507cc 153 CID	1986-1988	Base, SE; High performance	<b>US7110H</b>
1.6L L4 1587cc 97 CID	2001-2009		<b>US8937</b>	2.6L L4 2555cc 156 CID	1985	SE	<b>US7111</b>
<b>207</b>				<b>CHAMP</b>			
1.6L L4 1598cc 98 CID	2008-2009		<b>US8937</b>	1.4L L4 1410cc	1979		<b>US7106</b>
1.6L L4 1598cc 98 CID	2010	CC	<b>US8937</b>	1.4L L4 1410cc	1980	Base	<b>US7106</b>
<b>306</b>				1.4L L4 1410cc	1981	Base	<b>US7115</b>
1.8L L4 1766cc 107 CID	2001-2002	Mexican Application	<b>US8974</b>	1.4L L4 1410cc	1982	Base, Custom, Deluxe	<b>US7115</b>
<b>307</b>				1.6L L4 1597cc 98 CID	1979		<b>US7104</b>
2.0L L4 1998cc 122 CID	2003-2010	Mexican Application	<b>US8954</b>	1.6L L4 1597cc 98 CID	1980	Base, Custom	<b>US7104</b>
<b>406</b>				1.6L L4 1597cc 98 CID	1981	Base, Custom	<b>US7108</b>
2.0L L4 1998cc 122 CID	2000-2005	Mexican Application	<b>US8954</b>	1.6L L4 1597cc 98 CID	1982	Custom	<b>US7108</b>
<b>505</b>				<b>COLT</b>			
2.0L L4 1971cc	1980-1982	Base	<b>US9193</b>	1.4L L4 1410cc	1979		<b>US7106</b>
2.0L L4 1971cc	1980-1987	With fixed fan	<b>US9480</b>	1.4L L4 1410cc	1983	Base, Deluxe	<b>US7115</b>
2.0L L4 1971cc	1983	Base, STI	<b>US9193</b>	1.4L L4 1410cc	1984	DL, E	<b>US7115</b>
2.0L L4 1971cc	1984-1986	GL, S, STI	<b>US9193</b>	1.5L L4 1468cc 90 CID	1985-1987	DL, E, Premier	<b>US7115</b>
2.0L L4 1971cc	1987	Liberte	<b>US9193</b>	1.5L L4 1468cc 90 CID	1988	Base, DL, E, Premier	<b>US7115</b>
2.2L L4 2155cc	1985-1991	With fixed fan	<b>US9480</b>	1.5L L4 1468cc 90 CID	1989	Base, DL, E, GT	<b>US7115</b>
2.3L L4 2304cc	1980-1985	With fixed fan	<b>US9480</b>	1.5L L4 1468cc 90 CID	1990	Base, DL, GL, GT	<b>US7115</b>
<b>GRAND RAID</b>				1.5L L4 1468cc 90 CID	1991-1994	Base, GL	<b>US7115</b>
1.6L L4 1587cc 97 CID	2007-2009		<b>US8937</b>	1.6L L4 1597cc 98 CID	1976-1977		<b>US1012</b>
<b>PARTNER</b>				1.6L L4 1597cc 98 CID	1978		<b>US7105</b>
1.6L L4 1587cc 97 CID	2004-2009		<b>US8937</b>	1.6L L4 1597cc 98 CID	1979		<b>US7104</b>
<b>PLYMOUTH</b>				1.6L L4 1597cc 98 CID	1983	Base, Custom, Deluxe	<b>US7108</b>
<b>ACCLAIM</b>				1.6L L4 1597cc 98 CID	1984	DL, E	<b>US7108</b>
2.5L L4 2507cc 153 CID	1989	Base, LE	<b>US7122</b>	1.6L L4 1597cc 98 CID	1985-1986	DL, Premier	<b>US7108</b>
2.5L L4 2507cc 153 CID	1990-1991	Base, LE	<b>US7127</b>	1.6L L4 1597cc 98 CID	1987	Premier	<b>US7108</b>
2.5L L4 2507cc 153 CID	1992-1995	Base	<b>US7127</b>	1.6L L4 1597cc 98 CID	1988	DL, Premier	<b>US7108</b>
3.0L V6 2972cc 181 CID	1989	LX	<b>US7121</b>	1.6L L4 1597cc 98 CID	1988	DL, Premier	<b>US7108</b>
3.0L V6 2972cc 181 CID	1989	LX; With back plate housing	<b>US7121-2</b>	1.6L L4 1597cc 98 CID	1989-1990	GT	<b>US7131</b>
3.0L V6 2972cc 181 CID	1990-1991	Base, LE, LX	<b>US7121</b>	1.8L L4 1754cc 107 CID	1989-1990	DL	<b>US7108</b>
3.0L V6 2972cc 181 CID	1990-1991	Base, LE, LX; With back plate housing	<b>US7121-2</b>	1.8L L4 1834cc 112 CID	1992	Vista, Vista SE	<b>US7135</b>
				1.8L L4 1834cc 112 CID	1993	Base, GL, Vista	<b>US7135</b>
				1.8L L4 1834cc 112 CID	1994	Base, GL, Vista, Vista SE	<b>US7135</b>
				2.0L L4 1995cc 122 CID	1976-1978		<b>US7120</b>
				2.0L L4 1997cc 122 CID	1984-1991	Vista	<b>US7118</b>
				2.4L L4 2351cc	1992	Vista, Vista SE	<b>US9168</b>
				2.4L L4 2351cc	1993	Vista, Vista SE; From 11/03/1992	<b>US7148</b>

Engine	Years	Application Description	USMW	Engine	Years	Application Description	USMW
<b>PLYMOUTH (cont'd.)</b>				<b>PLYMOUTH (cont'd.)</b>			
<b>COLT (cont'd.)</b>				<b>GRAND VOYAGER (cont'd.)</b>			
2.4L L4 2351cc	1993	Vista, Vista SE; To 11/03/1992	US7148	3.8L V6 230 CID	1999	Expresso, SE	US7126
2.4L L4 2351cc	1994	Vista, Vista SE	US7148	3.8L V6 3800cc 232 CID	1997	Mexican Application	US7126
2.6L L4 2555cc 156 CID	1978-1979		US7120	<b>GRAN FURY</b>			
<b>CONQUEST</b>				3.7L L6 3687cc 225 CID	1980	Base, Salon	US7100
2.6L L4 2555cc 156 CID	1984	Base; Exc.Intercooler	US7115	3.7L L6 3687cc 225 CID	1981-1983	Base	US7100
2.6L L4 2555cc 156 CID	1985-1986	Base	US7120	5.2L V8 318 CID	1975-1977	Air Pump	US1053
<b>CRICKET</b>				5.2L V8 318 CID	1975-1977	Exc.Air Pump	US1053
1.5L L4 1498cc	1971-1973		US1010	5.2L V8 318 CID	1975-1977	Air Pump, High performance	US1053H
<b>CUSTOM</b>				5.2L V8 318 CID	1975-1977	Exc.Air Pump, High performance	US1053H
5.2L V8 5212cc 318 CID	1958-1961		US919	5.2L V8 318 CID	1980	Base, Salon	US1053
<b>DUSTER</b>				5.2L V8 318 CID	1980	Base, Salon; High performance	US1053H
3.7L L6 3687cc 225 CID	1975-1976		US7100	5.2L V8 318 CID	1981-1983	Base	US1053
5.2L V8 318 CID	1975-1976	Air Pump	US1053	5.2L V8 318 CID	1981-1983	Base; High performance	US1053H
5.2L V8 318 CID	1975-1976	Exc.Air Pump	US1053	5.2L V8 318 CID	1984-1987	Salon; High performance	US1053H
5.2L V8 318 CID	1975-1976	Air Pump, High performance	US1053H	5.2L V8 318 CID	1988	Base, Salon	US1053
5.2L V8 318 CID	1975-1976	Exc.Air Pump, High performance	US1053H	5.2L V8 318 CID	1988	Base, Salon; High performance	US1053H
5.9L V8 360 CID	1975-1976	Air Pump	US1053	5.2L V8 318 CID	1989	Salon	US1053
5.9L V8 360 CID	1975-1976	Exc.Air Pump	US1053	5.2L V8 318 CID	1989	Salon; High performance	US1053H
5.9L V8 360 CID	1975-1976	Air Pump, High performance	US1053H	5.2L V8 5211cc 318 CID	1985	Salon	US1053
5.9L V8 360 CID	1975-1976	Exc.Air Pump, High performance	US1053H	5.2L V8 5211cc 318 CID	1985	Salon; High performance	US1053H
<b>FLEET SPECIAL</b>				5.9L V8 360 CID	1975-1977	Air Pump	US1053
5.2L V8 5212cc 318 CID	1960-1963		US919	5.9L V8 360 CID	1975-1977	Exc.Air Pump	US1053
<b>FURY</b>				5.9L V8 360 CID	1975-1977	Air Pump, High performance	US1053H
3.7L L6 3687cc 225 CID	1975-1978		US7100	5.9L V8 360 CID	1975-1977	Exc.Air Pump, High performance	US1053H
4.5L V8 273 CID	1965		US919	5.9L V8 360 CID	1975-1977	Exc.Air Pump, High performance	US1053H
4.5L V8 4473cc 273 CID	1964-1965		US919	5.9L V8 360 CID	1980	Base, Salon	US1053
5.2L V8 317 CID	1958-1959		US919	5.9L V8 360 CID	1980	Base, Salon; High performance	US1053H
5.2L V8 318 CID	1959		US919	6.6L V8 400 CID	1975-1977		US1040
5.2L V8 318 CID	1965-1969		US919	7.2L V8 440 CID	1975-1977		US1040
5.2L V8 318 CID	1975-1978	Air Pump	US1053	<b>GTX</b>			
5.2L V8 318 CID	1975-1978	Exc.Air Pump	US1053	5.2L V8 318 CID	1968		US919
5.2L V8 318 CID	1975-1978	Air Pump, High performance	US1053H	5.2L V8 5212cc 318 CID	1968		US919
5.2L V8 318 CID	1975-1978	Exc.Air Pump, High performance	US1053H	<b>HORIZON</b>			
5.2L V8 5212cc 318 CID	1958-1969		US919	1.6L L4 1595cc 97 CID	1983	Base, Custom	US7113
5.9L V8 360 CID	1975-1978	Air Pump	US1053	1.6L L4 1595cc 97 CID	1984-1986	Base, SE	US7113
5.9L V8 360 CID	1975-1978	Exc.Air Pump	US1053	1.7L L4 105 CID	1978-1979		US7101
5.9L V8 360 CID	1975-1978	Air Pump, High performance	US1053H	1.7L L4 105 CID	1980	Base	US7101
5.9L V8 360 CID	1975-1978	Exc.Air Pump, High performance	US1053H	1.7L L4 105 CID	1981	Base, Miser	US7101
6.6L V8 400 CID	1975-1978		US1040	1.7L L4 105 CID	1982	Base, E-Type, Miser	US7101
7.2L V8 440 CID	1975		US1040	1.7L L4 105 CID	1983	Base, Custom	US7101
7.2L V8 440 CID	1977-1978		US1040	2.2L L4 135 CID	1981	Base, Miser	US7110
<b>FURY I</b>				2.2L L4 135 CID	1981	Base, Miser; High performance	US7110H
5.2L V8 318 CID	1968-1969		US919	2.2L L4 135 CID	1982	Base, E-Type, Miser	US7110
5.2L V8 5212cc 318 CID	1968-1969		US919	2.2L L4 135 CID	1982	Base, E-Type, Miser; High performance	US7110H
<b>FURY II</b>				2.2L L4 135 CID	1983	Base, Custom	US7110
4.5L V8 273 CID	1965		US919	2.2L L4 135 CID	1983	Base, Custom; High performance	US7110H
5.2L V8 318 CID	1965-1969		US919	2.2L L4 135 CID	1984-1986	Base, SE	US7110
5.2L V8 5212cc 318 CID	1968-1969		US919	2.2L L4 135 CID	1984-1986	Base, SE; High performance	US7110H
<b>FURY III</b>				2.2L L4 135 CID	1987-1988	America	US7110
4.5L V8 273 CID	1965		US919	2.2L L4 135 CID	1987-1988	America; High performance	US7110H
5.2L V8 318 CID	1965-1969		US919	2.2L L4 135 CID	1989	America	US7122
5.2L V8 5212cc 318 CID	1968-1969		US919	2.2L L4 135 CID	1990	Base	US7127
<b>GRAND VOYAGER</b>				<b>LASER</b>			
2.4L L4 2429cc 148 CID	1996	Base, SE; Hydraulic Tensioner	US7153	1.8L L4 1755cc 107 CID	1990	Base, RS	US7108
2.4L L4 2429cc 148 CID	1996	Base, SE; Mechanical Tensioner	US7156	1.8L L4 1755cc 107 CID	1991-1994	Base	US7108
2.4L L4 2429cc 148 CID	1997	Base, SE	US7156	2.0L L4 1997cc 122 CID	1990-1994	RS	US9212
2.5L L4 2507cc 153 CID	1988	SE	US7110	<b>NEON</b>			
2.5L L4 2507cc 153 CID	1988	SE; High performance	US7110H	2.0L L4 1996cc 122 CID	1995-1996	Base, High Line, Sport	US7150
3.0L V6 2972cc 181 CID	1988	LE	US7121	2.0L L4 1996cc 122 CID	1997	Base, High Line	US7150
3.0L V6 2972cc 181 CID	1988	LE; With back plate housing	US7121-2	2.0L L4 1996cc 122 CID	1998-1999	ACR, Expresso, High Line, Style	US7150
3.0L V6 2972cc 181 CID	1989	LE, SE	US7121	2.0L L4 1996cc 122 CID	2000-2001	High Line, LX	US7150
3.0L V6 2972cc 181 CID	1989	LE, SE; With back plate housing	US7121-2	<b>PB100</b>			
3.0L V6 2972cc 181 CID	1992-1993	Base, LE, SE	US7121	3.7L L6 3687cc 225 CID	1975-1979		US7100
3.0L V6 2972cc 181 CID	1992-1993	Base, LE, SE; With back plate housing	US7121-2	3.7L L6 3687cc 225 CID	1980	Voyager	US7100
3.0L V6 2972cc 181 CID	1994	Base	US7121	5.2L V8 5211cc 318 CID	1975-1978	Exc.Air Pump	US1053
3.0L V6 2972cc 181 CID	1994	Base; With back plate housing	US7121-2	5.2L V8 5211cc 318 CID	1975-1978	Exc.Air Pump, High performance	US1053H
3.0L V6 2972cc 181 CID	1995-1997	Base, SE	US7121	5.2L V8 5211cc 318 CID	1975-1979	Air Pump	US1053
3.0L V6 2972cc 181 CID	1995-1997	Base, SE; With back plate housing	US7121-2	5.2L V8 5211cc 318 CID	1975-1979	Air Pump, High performance	US1053H
3.0L V6 2972cc 181 CID	1998-1999	Base, Expresso, SE	US7121	5.2L V8 5211cc 318 CID	1980	Voyager	US1053
3.0L V6 2972cc 181 CID	1998-1999	Base, Expresso, SE; With back plate housing	US7121-2	5.2L V8 5211cc 318 CID	1980	Voyager; High performance	US1053H
3.0L V6 2972cc 181 CID	2000	Base, SE	US7121	5.9L V8 360 CID	1976-1978	Air Pump	US1053
3.0L V6 2972cc 181 CID	2000	Base, SE; With back plate housing	US7121-2	5.9L V8 360 CID	1976-1978	Exc.Air Pump	US1053
3.3L V6 3301cc 201 CID	1990-1994	LE, SE	US7126	5.9L V8 360 CID	1976-1978	Air Pump, High performance	US1053H
3.3L V6 3301cc 201 CID	1995	LE	US7126	5.9L V8 360 CID	1976-1978	Exc.Air Pump, High performance	US1053H
3.3L V6 3301cc 201 CID	1996	SE	US7126	<b>PB150</b>			
3.3L V6 3301cc 201 CID	1997	Base, SE	US7126	3.7L L6 3687cc 225 CID	1981-1983	Voyager	US7100
3.3L V6 3301cc 201 CID	1998-1999	Base, Expresso, SE	US7126	5.2L V8 5211cc 318 CID	1981	Voyager	US1053
3.3L V6 3301cc 201 CID	2000	Base, SE	US7126	5.2L V8 5211cc 318 CID	1981	Voyager; High performance	US1053H
3.8L V6 230 CID	1994-1995	LE	US7126	5.2L V8 5211cc 318 CID	1983	Voyager	US1053
				5.2L V8 5211cc 318 CID	1983	Voyager; High performance	US1053H

WATER PUMPS



Engine	Years	Application Description	USMW	Engine	Years	Application Description	USMW
<b>PLYMOUTH (cont'd.)</b>				<b>PLYMOUTH (cont'd.)</b>			
<b>PB200</b>				<b>SATELLITE (cont'd.)</b>			
3.7L L6 3687cc 225 CID	1975-1978		<b>US7100</b>	4.5L V8 4473cc 273 CID	1965-1968		<b>US919</b>
3.7L L6 3687cc 225 CID	1980	Voyager	<b>US7100</b>	5.2L V8 318 CID	1968-1969		<b>US919</b>
5.2L V8 5211cc 318 CID	1975-1978	Exc.Air Pump	<b>US1053</b>	5.2L V8 5212cc 318 CID	1965-1969		<b>US919</b>
5.2L V8 5211cc 318 CID	1975-1978	Exc.Air Pump, High performance	<b>US1053H</b>	5.6L V8 5572cc 340 CID	1968-1969		<b>US919</b>
5.2L V8 5211cc 318 CID	1975-1979	Air Pump	<b>US1053</b>	<b>SAVOY</b>			
5.2L V8 5211cc 318 CID	1975-1979	Air Pump, High performance	<b>US1053H</b>	3.8L L6 3770cc 230 CID	1955-1956		<b>US713</b>
5.2L V8 5211cc 318 CID	1980	Voyager	<b>US1053</b>	4.5L V8 4473cc 273 CID	1964		<b>US919</b>
5.2L V8 5211cc 318 CID	1980	Voyager; High performance	<b>US1053H</b>	5.2L V8 317 CID	1958-1959		<b>US919</b>
5.9L V8 360 CID	1975-1978	Exc.Air Pump	<b>US1053</b>	5.2L V8 318 CID	1960-1961		<b>US919</b>
5.9L V8 360 CID	1975-1978	Exc.Air Pump, High performance	<b>US1053H</b>	5.2L V8 5212cc 318 CID	1958-1964		<b>US919</b>
5.9L V8 360 CID	1975-1979	Air Pump	<b>US1053</b>	<b>SCAMP</b>			
5.9L V8 360 CID	1975-1979	Air Pump, High performance	<b>US1053H</b>	2.2L L4 135 CID	1983	Base	<b>US7110</b>
5.9L V8 360 CID	1980	Voyager	<b>US1053</b>	2.2L L4 135 CID	1983	Base; High performance	<b>US7110H</b>
5.9L V8 360 CID	1980	Voyager; High performance	<b>US1053H</b>	3.7L L6 3687cc 225 CID	1975-1976		<b>US7100</b>
6.6L V8 400 CID	1976-1978		<b>US1040</b>	5.2L V8 318 CID	1975-1976	Air Pump	<b>US1053</b>
7.2L V8 440 CID	1976-1978		<b>US1040</b>	5.2L V8 318 CID	1975-1976	Exc.Air Pump	<b>US1053</b>
<b>PB250</b>				<b>SPORT WAGON</b>			
3.7L L6 3687cc 225 CID	1981-1983	Voyager	<b>US7100</b>	5.2L V8 5212cc 318 CID	1960-1961		<b>US919</b>
5.2L V8 5211cc 318 CID	1981-1983	Voyager	<b>US1053</b>	<b>SUBURBAN</b>			
5.2L V8 5211cc 318 CID	1981-1983	Voyager; High performance	<b>US1053H</b>	5.2L V8 317 CID	1958-1959		<b>US919</b>
5.9L V8 360 CID	1981	Voyager	<b>US1053</b>	5.2L V8 318 CID	1958-1961		<b>US919</b>
5.9L V8 360 CID	1981	Voyager; High performance	<b>US1053H</b>	5.2L V8 5212cc 318 CID	1958-1961		<b>US919</b>
<b>PB300</b>				<b>SUNDANCE</b>			
5.2L V8 5211cc 318 CID	1975-1978	Exc.Air Pump	<b>US1053</b>	2.2L L4 135 CID	1987	Base	<b>US7110</b>
5.2L V8 5211cc 318 CID	1975-1978	Exc.Air Pump, High performance	<b>US1053H</b>	2.2L L4 135 CID	1987	Base; High performance	<b>US7110H</b>
5.2L V8 5211cc 318 CID	1975-1979	Air Pump	<b>US1053</b>	2.2L L4 135 CID	1988	Base, RS	<b>US7110</b>
5.2L V8 5211cc 318 CID	1975-1979	Air Pump, High performance	<b>US1053H</b>	2.2L L4 135 CID	1988	Base, RS; High performance	<b>US7110H</b>
5.2L V8 5211cc 318 CID	1980	Voyager	<b>US1053</b>	2.2L L4 135 CID	1989	Base	<b>US7122</b>
5.2L V8 5211cc 318 CID	1980	Voyager; High performance	<b>US1053H</b>	2.2L L4 135 CID	1990	Base	<b>US7127</b>
5.9L V8 360 CID	1975-1978	Exc.Air Pump	<b>US1053</b>	2.2L L4 135 CID	1991-1992	America, High Line	<b>US7127</b>
5.9L V8 360 CID	1975-1978	Exc.Air Pump, High performance	<b>US1053H</b>	2.2L L4 135 CID	1993-1994	Base	<b>US7127</b>
5.9L V8 360 CID	1975-1979	Air Pump	<b>US1053</b>	2.5L L4 2507cc 153 CID	1988	Base	<b>US7110</b>
5.9L V8 360 CID	1975-1979	Air Pump, High performance	<b>US1053H</b>	2.5L L4 2507cc 153 CID	1988	Base; High performance	<b>US7110H</b>
5.9L V8 360 CID	1980	Voyager	<b>US1053</b>	2.5L L4 2507cc 153 CID	1989	Base, RS	<b>US7122</b>
5.9L V8 360 CID	1980	Voyager; High performance	<b>US1053H</b>	2.5L L4 2507cc 153 CID	1990	Base, RS	<b>US7127</b>
6.6L V8 400 CID	1976-1978		<b>US1040</b>	2.5L L4 2507cc 153 CID	1991	High Line, RS	<b>US7127</b>
7.2L V8 440 CID	1976-1978		<b>US1040</b>	2.5L L4 2507cc 153 CID	1992	Duster, High Line	<b>US7127</b>
<b>PB350</b>				<b>TC3</b>			
5.2L V8 5211cc 318 CID	1981-1983	Voyager	<b>US1053</b>	1.7L L4 105 CID	1980	Base	<b>US7101</b>
5.2L V8 5211cc 318 CID	1981-1983	Voyager; High performance	<b>US1053H</b>	1.7L L4 105 CID	1981	Base, Miser	<b>US7101</b>
5.9L V8 360 CID	1981-1983	Voyager	<b>US1053</b>	1.7L L4 105 CID	1982	Custom, Miser	<b>US7101</b>
5.9L V8 360 CID	1981-1983	Voyager; High performance	<b>US1053H</b>	2.2L L4 135 CID	1981	Base, Miser	<b>US7110</b>
<b>PLAZA</b>				<b>TRAILDUSTER</b>			
3.8L L6 3770cc 230 CID	1955-1956		<b>US713</b>	3.7L L6 3687cc 225 CID	1975-1979		<b>US7100</b>
5.2L V8 317 CID	1958		<b>US919</b>	3.7L L6 3687cc 225 CID	1980	Base	<b>US7100</b>
5.2L V8 5212cc 318 CID	1958		<b>US919</b>	5.2L V8 5211cc 318 CID	1975-1978	Exc.Air Pump	<b>US1053</b>
<b>PROWLER</b>				<b>TURISMO</b>			
3.5L V6 3497cc 215 CID	1997	Base; 3 Bolt Pattern	<b>US7151</b>	1.6L L4 1595cc 97 CID	1983-1984	Base	<b>US7113</b>
3.5L V6 3497cc 215 CID	1997	Base; 6 Bolt Pattern	<b>US7158</b>	1.6L L4 1595cc 97 CID	1986	Base	<b>US7113</b>
3.5L V6 3497cc 215 CID	1999-2001	Base	<b>US7162</b>	1.7L L4 105 CID	1983	Base	<b>US7101</b>
<b>RELIANT</b>				<b>TURISMO 2.2</b>			
2.2L L4 135 CID	1981-1984	Base, Custom, SE	<b>US7110</b>	2.2L L4 135 CID	1983-1984	Base	<b>US7110</b>
2.2L L4 135 CID	1981-1984	Base, Custom, SE; High performance	<b>US7110H</b>	2.2L L4 135 CID	1983-1984	Base; High performance	<b>US7110H</b>
2.2L L4 135 CID	1985-1986	Base, LE, SE	<b>US7110</b>	2.2L L4 135 CID	1986-1987	Base	<b>US7110</b>
2.2L L4 135 CID	1985-1986	Base, LE, SE; High performance	<b>US7110H</b>	2.2L L4 135 CID	1986-1987	Base; High performance	<b>US7110H</b>
2.2L L4 135 CID	1987	Base, LE	<b>US7110</b>	<b>TURISMO</b>			
2.2L L4 135 CID	1987	Base, LE; High performance	<b>US7110H</b>	3.7L L6 3687cc 225 CID	1975-1979		<b>US7100</b>
2.2L L4 135 CID	1988	America	<b>US7110</b>	3.7L L6 3687cc 225 CID	1980	Base	<b>US7100</b>
2.2L L4 135 CID	1988	America; High performance	<b>US7110H</b>	5.2L V8 5211cc 318 CID	1975-1978	Exc.Air Pump	<b>US1053</b>
2.2L L4 135 CID	1989	America	<b>US7122</b>	5.2L V8 5211cc 318 CID	1975-1978	Exc.Air Pump, High performance	<b>US1053H</b>
2.5L L4 2507cc 153 CID	1986	LE, SE	<b>US7110</b>	5.2L V8 5211cc 318 CID	1975-1979	Air Pump	<b>US1053</b>
2.5L L4 2507cc 153 CID	1986	LE, SE; High performance	<b>US7110H</b>	5.2L V8 5211cc 318 CID	1975-1979	Air Pump, High performance	<b>US1053H</b>
2.5L L4 2507cc 153 CID	1987	LE	<b>US7110</b>	5.2L V8 5211cc 318 CID	1980-1981	Base	<b>US1053</b>
2.5L L4 2507cc 153 CID	1987	LE; High performance	<b>US7110H</b>	5.2L V8 5211cc 318 CID	1980-1981	Base; High performance	<b>US1053H</b>
2.5L L4 2507cc 153 CID	1988	America	<b>US7110</b>	5.9L V8 360 CID	1975-1978	Exc.Air Pump	<b>US1053</b>
2.5L L4 2507cc 153 CID	1988	America; High performance	<b>US7110H</b>	5.9L V8 360 CID	1975-1978	Exc.Air Pump, High performance	<b>US1053H</b>
2.5L L4 2507cc 153 CID	1989	America	<b>US7122</b>	5.9L V8 360 CID	1975-1979	Air Pump	<b>US1053</b>
2.6L L4 2555cc 156 CID	1981-1984	Base, Custom, SE	<b>US7111</b>	5.9L V8 360 CID	1975-1979	Air Pump, High performance	<b>US1053H</b>
2.6L L4 2555cc 156 CID	1985	LE, SE	<b>US7111</b>	5.9L V8 360 CID	1980-1981	Base	<b>US1053</b>
<b>ROAD RUNNER</b>				<b>TURISMO</b>			
4.5L V8 273 CID	1968		<b>US919</b>	1.6L L4 1595cc 97 CID	1983-1984	Base	<b>US7113</b>
4.5L V8 4473cc 273 CID	1968		<b>US919</b>	1.6L L4 1595cc 97 CID	1986	Base	<b>US7113</b>
5.2L V8 318 CID	1968		<b>US919</b>	1.7L L4 105 CID	1983	Base	<b>US7101</b>
5.2L V8 5212cc 318 CID	1968		<b>US919</b>	2.2L L4 135 CID	1983-1984	Base	<b>US7110</b>
5.6L V8 5572cc 340 CID	1968		<b>US919</b>	2.2L L4 135 CID	1983-1984	Base; High performance	<b>US7110H</b>
<b>SAPPORO</b>				<b>TURISMO 2.2</b>			
1.6L L4 1597cc 98 CID	1978-1979		<b>US7105</b>	2.2L L4 135 CID	1983-1986	Base	<b>US7110</b>
2.6L L4 2555cc 156 CID	1978-1979		<b>US7120</b>	2.2L L4 135 CID	1983-1986	Base; High performance	<b>US7110H</b>
2.6L L4 2555cc 156 CID	1980-1981	Base	<b>US7120</b>	<b>TURISMO</b>			
<b>SATELLITE</b>				<b>TURISMO</b>			
4.5L V8 273 CID	1968		<b>US919</b>	2.2L L4 135 CID	1983-1986	Base	<b>US7110</b>
				<b>TURISMO</b>			
				<b>TURISMO</b>			

Engine	Years	Application Description	USMW	Engine	Years	Application Description	USMW
<b>PLYMOUTH (cont'd.)</b>				<b>PONTIAC (cont'd.)</b>			
<b>VALIANT</b>				<b>6000 (cont'd.)</b>			
3.7L L6 3687cc 225 CID	1975-1976		US7100	2.8L V6 173 CID	1987-1988	Base, LE, SE, STE	US5033
3.7L L6 3700cc 225 CID	1974-1976	Mexican Application	US7100	2.8L V6 173 CID	1989	LE, Special Edition	US5033
3.7L L6 3700cc 225 CID	1981	Mexican Application	US7100	3.1L V6 189 CID	1988-1989	STE	US5033
4.5L V8 273 CID	1964-1969		US919	3.1L V6 189 CID	1990-1991	LE, Special Edition	US5033
4.5L V8 4473cc 273 CID	1964-1969		US919	4.3L V6 260 CID	1982-1985	Base, LE; W/O Pulley	US5014
5.2L V8 318 CID	1968-1969		US919	4.3L V6 260 CID	1982-1985	Base, LE; Includes pulley	US5014P
5.2L V8 318 CID	1975-1976	Air Pump	US1053	<b>ACADIAN</b>			
5.2L V8 318 CID	1975-1976	Exc.Air Pump	US1053	5.7L V8 5736cc 350 CID	1968		US850
5.2L V8 318 CID	1975-1976	Air Pump, High performance	US1053H	<b>ASTRE</b>			
5.2L V8 318 CID	1975-1976	Exc.Air Pump, High performance	US1053H	2.3L L4 2294cc 140 CID	1975		US1088
5.2L V8 5212cc 318 CID	1968-1969		US919	2.5L L4 2474cc 151 CID	1977		US1107
5.2L V8 5212cc 318 CID	1970-1974		US1053	<b>AZTEK</b>			
5.2L V8 5212cc 318 CID	1970-1974	High performance	US1053H	3.4L V6 207 CID	2001	Base, GT	US5033
5.6L V8 5572cc 340 CID	1968-1969		US919	3.4L V6 207 CID	2002-2003	Base	US5033
5.9L V8 360 CID	1976	Air Pump	US1053	3.4L V6 207 CID	2004-2005	Base, Rally	US5033
5.9L V8 360 CID	1976	Exc.Air Pump	US1053	<b>BONNEVILLE</b>			
5.9L V8 360 CID	1976	Air Pump, High performance	US1053H	3.8L V6 3800cc 231 CID	1980	Base	US1018
5.9L V8 360 CID	1976	Exc.Air Pump, High performance	US1053H	3.8L V6 3800cc 231 CID	1980	Base; High performance	US1018H
<b>VIP</b>				3.8L V6 3800cc 231 CID	1981-1983	Base, Brougham	US1018
5.2L V8 5212cc 318 CID	1967		US919	3.8L V6 3800cc 231 CID	1981-1983	Base, Brougham; High performance	US1018H
<b>VOLARE</b>				3.8L V6 3800cc 231 CID	1984-1986	Base, Brougham, LE	US1018
2.2L L4 2200cc 135 CID	1982-1988	Mexican Application	US7110	3.8L V6 3800cc 231 CID	1984-1986	Base, Brougham, LE; High performance	US1018H
3.7L L6 3687cc 225 CID	1976-1979		US7100	3.8L V6 3800cc 231 CID	1987	Base, LE	US5050
3.7L L6 3687cc 225 CID	1980	Base	US7100	3.8L V6 3800cc 231 CID	1988-1991	LE, SE, SSE	US5050
3.7L L6 3700cc 225 CID	1982	Mexican Application	US7100	3.8L V6 3800cc 231 CID	1992-1995	SE, SSE, SSEi	US5050
5.2L V8 318 CID	1976-1978	Exc.Air Pump	US1053	3.8L V6 3800cc 231 CID	1996-1999	SE, SSE, SSEi	US5075
5.2L V8 318 CID	1976-1978	Exc.Air Pump, High performance	US1053H	3.8L V6 3800cc 231 CID	2000-2003	SE, SLE, SSEi	US5075
5.2L V8 318 CID	1976-1979	Air Pump	US1053	3.8L V6 3800cc 231 CID	2004-2005	SE, SLE	US5075
5.2L V8 318 CID	1976-1979	Air Pump, High performance	US1053H	4.1L V6 252 CID	1982	Base, Brougham	US1018
5.2L V8 318 CID	1980	Base	US1053	4.1L V6 252 CID	1982	Base, Brougham; High performance	US1018H
5.2L V8 318 CID	1980	Base; High performance	US1053H	4.3L V6 262 CID	1986	Base, Brougham, LE	US1121
5.9L V8 360 CID	1976-1978	Exc.Air Pump	US1053	4.3L V6 262 CID	1986	Base, Brougham, LE; High performance	US1121H
5.9L V8 360 CID	1976-1978	Exc.Air Pump, High performance	US1053H	4.3L V6 262 CID	1986	Base, Brougham	US975
5.9L V8 360 CID	1976-1979	Air Pump	US1053	4.3L V8 265 CID	1980-1981	Base, Brougham	US975
5.9L V8 360 CID	1976-1979	Air Pump, High performance	US1053H	4.6L V8 281 CID	2004-2005	GXP	US5072
5.9L V8 360 CID	1980	Base	US1053	4.9L V8 301 CID	1977-1979		US975
5.9L V8 360 CID	1980	Base; High performance	US1053H	4.9L V8 301 CID	1980	Base, Brougham, Safari	US975
<b>VOYAGER</b>				4.9L V8 301 CID	1983	Base, Brougham	US1121
2.2L L4 135 CID	1984-1987	Base, LE, SE	US7110	5.0L V8 305 CID	1983	Base, Brougham; High performance	US1121H
2.2L L4 135 CID	1984-1987	Base, LE, SE; High performance	US7110H	5.0L V8 305 CID	1984-1986	Base, Brougham, LE	US1121
2.4L L4 2429cc 148 CID	1996	Base, SE; Hydraulic Tensioner	US7153	5.0L V8 305 CID	1984-1986	Base, Brougham, LE; High performance	US1121H
2.4L L4 2429cc 148 CID	1996	Base, SE; Mechanical Tensioner	US7156	5.0L V8 307 CID	1981	Base, Brougham, Safari; Exc.Air Cond	US1100
2.4L L4 2429cc 148 CID	1997	Base, SE	US7156	5.0L V8 307 CID	1981	Base, Brougham, Safari; With air cond.	US1120
2.4L L4 2429cc 148 CID	1998-2000	Base	US7156	5.0L V8 307 CID	1981	Base, Brougham, Safari; High performance, With air cond.	US1120H
2.5L L4 2507cc 153 CID	1987	SE	US7110	5.7L V8 350 CID	1977-1978		US975
2.5L L4 2507cc 153 CID	1987	SE; High performance	US7110H	5.7L V8 350 CID	1977-1979	Exc.Air Cond	US1100
2.5L L4 2507cc 153 CID	1988	Base, LE, SE	US7110	5.7L V8 350 CID	1977-1979	Air Cond	US1120
2.5L L4 2507cc 153 CID	1988	Base, LE, SE; High performance	US7110H	5.7L V8 350 CID	1977-1979	Air Cond, High performance	US1120H
2.5L L4 2507cc 153 CID	1989	Base, LE, SE	US7122	5.7L V8 350 CID	1979		US1018
2.5L L4 2507cc 153 CID	1990-1991	Base, LE, LX, SE	US7127	5.7L V8 350 CID	1979	High performance	US1018H
2.5L L4 2507cc 153 CID	1992-1993	Base, SE	US7127	5.7L V8 350 CID	1980	Brougham, Safari	US1018
2.5L L4 2507cc 153 CID	1994-1995	Base	US7127	5.7L V8 350 CID	1980	Brougham, Safari; High performance	US1018H
2.6L L4 2555cc 156 CID	1984-1987	Base, LE, SE	US7111	5.7L V8 350 CID	1980-1981	Base, Brougham, Safari; Exc.Air Cond	US1100
3.0L V6 2972cc 181 CID	1987-1989	LE, SE	US7121	5.7L V8 350 CID	1980-1981	Base, Brougham, Safari; With air cond.	US1120
3.0L V6 2972cc 181 CID	1987-1989	LE, SE; With back plate housing	US7121-2	5.7L V8 350 CID	1980-1981	Base, Brougham, Safari; High performance, With air cond.	US1120H
3.0L V6 2972cc 181 CID	1990	LE, LX, SE	US7121	5.7L V8 350 CID	1982-1983	Base, Brougham; 5" Cast, Exc.Air Cond	US1100
3.0L V6 2972cc 181 CID	1990	LE, LX, SE; With back plate housing	US7121-2	5.7L V8 350 CID	1982-1983	Base, Brougham; Exc.5" Cast, Exc.Air Cond	US1120
3.0L V6 2972cc 181 CID	1991-1994	Base, LE, LX, SE	US7121	5.7L V8 350 CID	1982-1983	Base, Brougham; With air cond.	US1120
3.0L V6 2972cc 181 CID	1991-1994	Base, LE, LX, SE; With back plate housing	US7121-2	5.7L V8 350 CID	1982-1983	Base, Brougham; Exc.5" Cast, Exc.Air Cond, High performance	US1120H
3.0L V6 2972cc 181 CID	1995	Base, LE, SE	US7121	5.7L V8 350 CID	1982-1983	Base, Brougham; High performance, With air cond.	US1120H
3.0L V6 2972cc 181 CID	1995	Base, LE, SE; With back plate housing	US7121-2	5.7L V8 350 CID	1984	Base, Brougham, LE; 5" Cast, Exc.Air Cond	US1100
3.0L V6 2972cc 181 CID	1996-1998	Base, SE	US7121	5.7L V8 350 CID	1984	Base, Brougham, LE; Exc.5" Cast, Exc.Air Cond	US1120
3.0L V6 2972cc 181 CID	1996-1998	Base, SE; With back plate housing	US7121-2	5.7L V8 350 CID	1984	Base, Brougham, LE; With air cond.	US1120
3.0L V6 2972cc 181 CID	1999-2000	Base	US7121	5.7L V8 350 CID	1984	Base, Brougham, LE; Exc.5" Cast, Exc.Air Cond, High performance	US1120H
3.0L V6 2972cc 181 CID	1999-2000	Base; With back plate housing	US7121-2	5.7L V8 350 CID	1984	Base, Brougham, LE; Exc.5" Cast, Exc.Air Cond, High performance	US1120H
3.3L V6 3301cc 201 CID	1991-1993	LE, SE	US7126	5.7L V8 350 CID	1984	Base, Brougham, LE; High performance, With air cond.	US1120H
3.3L V6 3301cc 201 CID	1994	Base, LE, LX, SE	US7126	6.4L V8 389 CID	1959-1962		US850
3.3L V6 3301cc 201 CID	1995	Base, LE, SE	US7126	6.4L V8 6376cc 389 CID	1959-1966		US850
3.3L V6 3301cc 201 CID	1996	SE	US7126	6.6L V8 400 CID	1968		US850
3.3L V6 3301cc 201 CID	1997	Base, SE	US7126	6.6L V8 400 CID	1975-1978		US975
3.3L V6 3301cc 201 CID	1997	Base, SE	US7126	6.6L V8 400 CID	1975-1978	Exc.Air Cond	US1100
3.3L V6 3301cc 201 CID	1998-1999	Base, Espresso, SE	US7126	6.6L V8 400 CID	1975-1978	Air Cond	US1120
3.3L V6 3301cc 201 CID	2000	Base, SE	US7126	6.6L V8 400 CID	1975-1978	Air Cond, High performance	US1120H
3.8L V6 230 CID	1999	Espresso, SE	US7126	6.6L V8 403 CID	1977-1979		US975
<b>PONTIAC</b>				6.6L V8 403 CID	1977-1979	Exc.Air Cond	US1100
<b>6000</b>				6.6L V8 403 CID	1977-1979	Air Cond	US1120
2.5L L4 2474cc 151 CID	1982-1986	Base, LE	US5000	<b>WATER PUMPS</b>			
2.5L L4 2474cc 151 CID	1982-1986	Base, LE; Includes pulley	US5000P				
2.5L L4 2474cc 151 CID	1987-1989	Base, LE	US5041				
2.5L L4 2474cc 151 CID	1990-1991	LE	US5041				
2.8L V6 173 CID	1982	Base, LE	US5001				
2.8L V6 173 CID	1983-1985	Base, LE, STE	US5001				
2.8L V6 173 CID	1986	Base, LE, SE, STE	US5001				



# WATER PUMP APPLICATION GUIDE



Engine	Years	Application Description	USMW	Engine	Years	Application Description	USMW
<b>PONTIAC (cont'd.)</b>				<b>PONTIAC (cont'd.)</b>			
<b>BONNEVILLE (cont'd.)</b>				<b>FIREBIRD (cont'd.)</b>			
6.6L V8 403 CID	1977-1979	Air Cond, High performance	US1120H	5.0L V8 305 CID	1977-1979	High performance	US1121H
6.6L V8 6555cc 400 CID	1967-1968		US850	5.0L V8 305 CID	1980	Base, Esprit, Formula, Trans Am	US1121
6.9L V8 6900cc 421 CID	1963-1966		US850	5.0L V8 305 CID	1980	Base, Esprit, Formula, Trans Am; High performance	US1121H
7.0L V8 428 CID	1968		US850	5.0L V8 305 CID	1981	Formula, Trans Am	US1121
7.0L V8 7014cc 428 CID	1967-1968		US850	5.0L V8 305 CID	1981	Formula, Trans Am; High performance	US1121H
7.5L V8 455 CID	1975-1976		US975	5.0L V8 305 CID	1982-1986	Base, S/E, Trans Am	US1121
<b>CATALINA</b>				5.0L V8 305 CID	1982-1986	Base, S/E, Trans Am; High performance	US1121H
3.8L V6 3800cc 231 CID	1978-1979		US1018	5.0L V8 305 CID	1987	Base, Trans Am	US1121
3.8L V6 3800cc 231 CID	1978-1979	High performance	US1018H	5.0L V8 305 CID	1987	Base, Trans Am; High performance	US1121H
3.8L V6 3800cc 231 CID	1980-1981	Base	US1018	5.0L V8 305 CID	1988	Base, Trans Am	US5049
3.8L V6 3800cc 231 CID	1980-1981	Base; High performance	US1018H	5.0L V8 305 CID	1988	Base, Trans Am; High performance	US5049H
4.1L L6 250 CID	1977-1979		US975	5.0L V8 305 CID	1989-1992	Base, Formula, Trans Am, Trans Am GTA	US5049
4.3L V8 265 CID	1980-1981	Base	US975	5.0L V8 305 CID	1989-1992	Base, Formula, Trans Am, Trans Am GTA; High performance	US5049H
4.9L V8 301 CID	1977-1979		US975	5.7L V8 350 CID	1968		US850
4.9L V8 301 CID	1980	Base, Safari	US975	5.7L V8 350 CID	1975-1976	Exc.Air Cond	US1100
5.0L V8 307 CID	1981	Base, Safari; Exc.Air Cond	US1100	5.7L V8 350 CID	1975-1978	Air Cond	US1120
5.0L V8 307 CID	1981	Base, Safari; With air cond.	US1120	5.7L V8 350 CID	1975-1978	Air Cond, High performance	US1120H
5.0L V8 307 CID	1981	Base, Safari; High performance, With air cond.	US1120H	5.7L V8 350 CID	1977-1979	High performance	US1121
5.7L V8 350 CID	1976-1977		US975	5.7L V8 350 CID	1979		US1121
5.7L V8 350 CID	1976-1979	Exc.Air Cond	US1100	5.7L V8 350 CID	1987	Base, Trans Am	US1121
5.7L V8 350 CID	1976-1979	Air Cond	US1120	5.7L V8 350 CID	1987	Base, Trans Am; High performance	US1121H
5.7L V8 350 CID	1976-1979	Air Cond, High performance	US1120H	5.7L V8 350 CID	1988	Trans Am	US5049
5.7L V8 350 CID	1978-1979		US1018	5.7L V8 350 CID	1988	Trans Am; High performance	US5049H
5.7L V8 350 CID	1978-1979	High performance	US1018H	5.7L V8 350 CID	1989-1992	Formula, Trans Am, Trans Am GTA	US5049
5.7L V8 350 CID	1980	Safari	US1018	5.7L V8 350 CID	1989-1992	Formula, Trans Am, Trans Am GTA; High performance	US5049H
5.7L V8 350 CID	1980	Safari; High performance	US1018H	5.7L V8 350 CID	1993	Formula, Trans Am	US5068
5.7L V8 350 CID	1980-1981	Base, Safari; Exc.Air Cond	US1100	5.7L V8 350 CID	1994	Formula, Trans Am, Trans Am GT	US5068
5.7L V8 350 CID	1980-1981	Base, Safari; With air cond.	US1120	5.7L V8 350 CID	1995-1997	Formula, Trans Am	US5068
5.7L V8 350 CID	1980-1981	Base, Safari; High performance, With air cond.	US1120H	5.7L V8 350 CID	1998-2002	Formula, Trans Am	US5081
6.4L V8 6376cc 389 CID	1959-1966		US850	5.7L V8 5733cc 350 CID	1968		US850
6.6L V8 400 CID	1967-1968		US850	6.6L V8 400 CID	1967-1968		US850
6.6L V8 400 CID	1975-1978		US975	6.6L V8 400 CID	1975-1979		US975
6.6L V8 400 CID	1975-1978	Exc.Air Cond	US1100	6.6L V8 400 CID	1975-1979	Exc.Air Cond	US1100
6.6L V8 400 CID	1975-1978	Air Cond	US1120	6.6L V8 400 CID	1975-1979	Air Cond	US1120
6.6L V8 400 CID	1975-1978	Air Cond, High performance	US1120H	6.6L V8 400 CID	1975-1979	Air Cond, High performance	US1120H
6.6L V8 403 CID	1977-1979		US975	6.6L V8 403 CID	1977-1979		US975
6.6L V8 403 CID	1977-1979	Exc.Air Cond	US1100	6.6L V8 403 CID	1977-1979	Exc.Air Cond	US1100
6.6L V8 403 CID	1977-1979	Air Cond	US1120	6.6L V8 403 CID	1977-1979	Air Cond	US1120
6.6L V8 403 CID	1977-1979	Air Cond, High performance	US1120H	6.6L V8 403 CID	1977-1979	Air Cond, High performance	US1120H
6.6L V8 6555cc 400 CID	1967-1968		US850	6.6L V8 6555cc 400 CID	1967-1968		US850
6.9L V8 6900cc 421 CID	1961-1966		US850	7.5L V8 455 CID	1975-1976		US975
7.0L V8 428 CID	1968		US850	<b>G3</b>			
7.0L V8 7014cc 428 CID	1967-1968		US850	1.6L L4 1598cc 98 CID	2009-2010	Base	US6184
7.5L V8 455 CID	1975-1976		US975	1.6L L4 1606cc 98 CID	2006-2008	Mexican Application	US6046
<b>EXECUTIVE</b>				<b>G4</b>			
6.6L V8 6555cc 400 CID	1967-1968		US850	2.2L L4 2190cc 134 CID	2005-2006	Mexican Application	US5092
7.0L V8 7014cc 428 CID	1967-1968		US850	2.4L L4 2395cc 146 CID	2006	Mexican Application	US5092
<b>FIERO</b>				<b>G5</b>			
2.5L L4 2474cc 151 CID	1984-1985	Base, SE, Sport	US5000	2.2L L4 2198cc 134 CID	2007-2008	Base	US5092
2.5L L4 2474cc 151 CID	1986-1987	SE, Sport, Value Leader	US5000	2.2L L4 2198cc 134 CID	2009	Base, GT	US5092
2.5L L4 2474cc 151 CID	1988	Sport, Value Leader	US5000	2.4L L4 2384cc 145 CID	2007-2008	GT	US5092
2.8L V6 173 CID	1985	GT, SE, Sport	US5001	<b>G6</b>			
2.8L V6 173 CID	1986-1987	GT, SE	US5001	2.4L L4 2384cc 145 CID	2006-2010	Base	US5092
2.8L V6 173 CID	1988	GT, Sport, Value Leader	US5001	3.5L V6 211 CID	2005	Base, GT	US5033
<b>FIREBIRD</b>				3.5L V6 214 CID	2006	Base, GT	US5033
2.5L L4 2474cc 151 CID	1982-1984	Base, S/E	US1107	3.5L V6 3490cc 213 CID	2007-2010	Base, GT	US6020
2.5L L4 2474cc 151 CID	1985-1986	Base	US5022	3.6L V6 3564cc 217 CID	2007	GTP	US8932
2.8L V6 173 CID	1982-1984	Base, S/E	US5006	3.6L V6 3564cc 217 CID	2008-2009	GXP	US8932
2.8L V6 173 CID	1985-1986	Base, S/E	US5001	3.9L V6 3880cc 237 CID	2006	GTP	US6020
2.8L V6 173 CID	1987-1989	Base	US5037	3.9L V6 3880cc 237 CID	2007-2009	GT	US6020
3.1L V6 189 CID	1990-1992	Base	US5037	<b>G8</b>			
3.4L V6 207 CID	1993-1995	Base	US5070	3.6L V6 3564cc 217 CID	2008-2009	Base	US8932
3.8L V6 231 CID	1977		US1018	6.0L V8 5967cc 364 CID	2008-2009	GT	US65N
3.8L V6 231 CID	1977	High performance	US1018H	6.0L V8 5967cc 364 CID	2008-2009	GT; Includes thermostat and thermostat housing	US65N-T
3.8L V6 3800cc 231 CID	1978-1979		US1018	6.2L V8 6162cc 376 CID	2009	GXP	US79
3.8L V6 3800cc 231 CID	1978-1979	High performance	US1018H	<b>GRAND AM</b>			
3.8L V6 3800cc 231 CID	1980	Base, Esprit	US1018	2.0L L4 122 CID	1987-1988	LE, SE	US5036
3.8L V6 3800cc 231 CID	1980	Base, Esprit; High performance	US1018H	2.0L L4 122 CID	1989	SE	US5036
3.8L V6 3800cc 231 CID	1981	Base, Esprit, Formula	US1018	2.2L L4 2198cc 134 CID	2002-2003	SE, SE1	US5092
3.8L V6 3800cc 231 CID	1981	Base, Esprit, Formula; High performance	US1018H	2.2L L4 2198cc 134 CID	2004-2005	SE	US5092
3.8L V6 3800cc 231 CID	1981	Trans Am, Trans Am GTA SE	US1018	2.3L L4 138 CID	1988	Base, LE, SE	US5043
3.8L V6 3800cc 231 CID	1989	Trans Am, Trans Am GTA SE; High performance	US1018H	2.3L L4 138 CID	1989-1991	LE, SE	US5043
3.8L V6 3800cc 231 CID	1989		US1018	2.3L L4 138 CID	1992-1995	GT, SE	US5043
3.8L V6 3800cc 231 CID	1995	Base	US5050	2.3L L4 140 CID	1989-1990	SE	US5043
3.8L V6 3800cc 231 CID	1996-2002	Base	US5075	2.3L L4 140 CID	1991	LE, SE	US5043
4.1L L6 250 CID	1974	With A/C	US927	2.3L L4 140 CID	1992-1994	GT	US5043
4.1L L6 250 CID	1975-1976		US1107	2.4L L4 2392cc 146 CID	1996-1999	GT, SE	US5076
4.3L V8 265 CID	1981	Base, Esprit, Formula	US975				
4.9L V8 301 CID	1977		US975				
4.9L V8 301 CID	1979		US975				
4.9L V8 301 CID	1980-1981	Base, Esprit, Formula, Trans Am	US975				
5.0L V8 305 CID	1977-1979		US1121				



Engine	Years	Application Description	USMW	Engine	Years	Application Description	USMW
<b>PONTIAC (cont'd.)</b>				<b>PONTIAC (cont'd.)</b>			
<b>GRAND AM (cont'd.)</b>				<b>GRAND PRIX (cont'd.)</b>			
2.4L L4 2392cc 146 CID	2000	SE, SE1, SE2	US5076	5.0L V8 305 CID	1983	Base, Brougham, LJ; High performance	US1121H
2.4L L4 2392cc 146 CID	2001	SE, SE1	US5076	5.0L V8 305 CID	1984-1987	Base, Brougham, LE	US1121
2.5L L4 2474cc 151 CID	1985-1986	Base, LE	US5000	5.0L V8 305 CID	1984-1987	Base, Brougham, LE; High performance	US1121H
2.5L L4 2474cc 151 CID	1985-1991	With Multi-Groove pulley	US5067	5.3L V8 5328cc 325 CID	2005-2008	GXP	US6154
2.5L L4 2474cc 151 CID	1987	Base, LE, SE	US5000	5.7L V8 350 CID	1976		US975
2.5L L4 2474cc 151 CID	1988	Base, LE	US5000	5.7L V8 350 CID	1976-1977	Exc.Air Cond	US1100
2.5L L4 2474cc 151 CID	1989-1990	LE	US5000	5.7L V8 350 CID	1976-1977	Air Cond	US1120
2.5L L4 2474cc 151 CID	1991	LE, Value Leader	US5000	5.7L V8 350 CID	1976-1977	Air Cond, High performance	US1120H
3.0L V6 181 CID	1985	Base, LE	US5050	5.7L V8 350 CID	1977	High performance	US1121H
3.0L V6 181 CID	1986-1987	Base, LE, SE	US5050	5.7L V8 350 CID	1981	Base, Brougham, LJ; Exc.Air Cond	US1100
3.1L V6 189 CID	1994-1998	GT, SE	US5033	5.7L V8 350 CID	1981-1983	Base, Brougham, LJ; With air cond.	US1120
3.3L V6 204 CID	1992-1993	GT, SE	US5050	5.7L V8 350 CID	1981-1983	Base, Brougham, LJ; High performance, With air cond.	US1120H
3.4L V6 207 CID	1999	GT, SE	US5033	5.7L V8 350 CID	1982-1983	Base, Brougham, LJ; 5" Cast, Exc.Air Cond	US1100
3.4L V6 207 CID	2000	GT, GT1, SE1, SE2	US5033	5.7L V8 350 CID	1982-1983	Base, Brougham, LJ; Exc.5" Cast, Exc.Air Cond	US1120
3.4L V6 207 CID	2001-2002	GT, GT1, SE1	US5033	5.7L V8 350 CID	1984	Base, Brougham, LE; 5" Cast, Exc.Air Cond	US1100
3.4L V6 207 CID	2003-2004	GT, GT1, SE1, SE2	US5033	5.7L V8 350 CID	1984	Base, Brougham, LE; Exc.5" Cast, Exc.Air Cond	US1120
3.4L V6 207 CID	2005	GT, GT1, SE	US5033	5.7L V8 350 CID	1984	Base, Brougham, LE; With air cond.	US1120
3.8L V6 3800cc 231 CID	1979		US1018	5.7L V8 350 CID	1984	Base, Brougham, LE; Exc.5" Cast, Exc.Air Cond, High performance	US1120H
3.8L V6 3800cc 231 CID	1979	High performance	US1018H	5.7L V8 350 CID	1984	Base, Brougham, LE; Exc.5" Cast, Exc.Air Cond, High performance	US1120H
4.9L V8 301 CID	1978-1979		US975	5.7L V8 350 CID	1984	Base, Brougham, LE; With air cond.	US1120
4.9L V8 301 CID	1980	Base	US975	5.7L V8 350 CID	1984	Base, Brougham, LE; Exc.5" Cast, Exc.Air Cond, High performance	US1120H
5.0L V8 305 CID	1978-1979	High performance	US1121	5.7L V8 350 CID	1984	Base, Brougham, LE; High performance, With air cond.	US1120H
5.0L V8 305 CID	1980	Base	US1121H	6.4L V8 6376cc 389 CID	1962-1966		US850
5.0L V8 305 CID	1980	Base; High performance	US1121H	6.6L V8 400 CID	1968		US850
5.7L V8 350 CID	1975		US975	6.6L V8 400 CID	1975-1977		US975
6.6L V8 400 CID	1975		US975	6.6L V8 400 CID	1975-1977	Exc.Air Cond	US1100
7.5L V8 455 CID	1975		US975	6.6L V8 400 CID	1975-1977	Air Cond	US1120
<b>GRAND LEMANS</b>				<b>GRAND SAFARI</b>			
3.8L V6 229 CID	1980	Base, Safari	US1121	4.9L V8 301 CID	1977		US975
3.8L V6 229 CID	1980	Base, Safari; High performance	US1121H	5.7L V8 350 CID	1977		US975
3.8L V6 3800cc 231 CID	1980-1981	Base, Safari	US1018	5.7L V8 350 CID	1977	Exc.Air Cond	US1100
3.8L V6 3800cc 231 CID	1980-1981	Base, Safari; High performance	US1018H	5.7L V8 350 CID	1977	Air Cond	US1120
4.3L V8 265 CID	1980-1981	Base, Safari	US975	5.7L V8 350 CID	1977	Air Cond, High performance	US1120H
4.9L V8 301 CID	1980	Base, Safari	US975	5.7L V8 350 CID	1977		US975
4.9L V8 301 CID	1981	Safari	US975	6.6L V8 400 CID	1975-1978	Exc.Air Cond	US1100
5.0L V8 305 CID	1980	Base, Safari	US1121	6.6L V8 400 CID	1975-1978	Air Cond	US1120
5.0L V8 305 CID	1980	Base, Safari; High performance	US1121H	6.6L V8 400 CID	1975-1978	Air Cond, High performance	US1120H
<b>GRAND PRIX</b>				<b>GTO</b>			
2.3L L4 138 CID	1990	LE	US5043	5.7L V8 350 CID	2004	Base	US5081
2.3L L4 138 CID	1991	LE, SE	US5043	6.0L V8 5967cc 364 CID	2005-2006	Base	US65
2.8L V6 173 CID	1988-1989	Base, LE, SE	US5033	6.0L V8 5967cc 364 CID	2005-2006	Base; Includes thermostat and thermostat housing	US65-T
3.1L V6 189 CID	1989	Base, LE, SE	US5033	6.4L V8 6376cc 389 CID	1964-1966		US850
3.1L V6 189 CID	1990	LE, McLaren, SE, STE	US5033	6.6L V8 400 CID	1967-1968		US850
3.1L V6 189 CID	1991-1993	GT, LE, SE, STE	US5033	6.6L V8 400 CID	1967-1968		US850
3.1L V6 189 CID	1994-1995	SE	US5033	6.6L V8 6555cc 400 CID	1967-1968		US850
3.1L V6 189 CID	1996	Base, SE	US5033	<b>J2000</b>			
3.1L V6 189 CID	1997-2003	SE	US5033	1.8L L4 112 CID	1982	Base, LE, SE	US5007
3.4L V6 207 CID	1991	GT, SE, STE	US5033	1.8L L4 112 CID	1982-1983	Base, LE, SE	US5036
3.4L V6 207 CID	1992-1993	GT, GTP, LE, SE, STE	US5033	<b>J2000 SUNBIRD</b>			
3.4L V6 207 CID	1994	SE	US5033	1.8L L4 112 CID	1984	Base, LE, SE	US5036
3.4L V6 207 CID	1995-1996	GT, GTP	US5033	1.8L L4 112 CID	1985	Base, LE, SE	US5017
3.8L V6 231 CID	1979		US1018	2.0L L4 122 CID	1984-1985	Base, LE	US5007
3.8L V6 231 CID	1979	High performance	US1018H	<b>LEMANS</b>			
3.8L V6 3800cc 231 CID	1978-1979		US1018	1.6L L4 1588cc 98 CID	1988	Aerocoupe, Aerocoupe YL, Base, SE, Value Leader	US5045
3.8L V6 3800cc 231 CID	1978-1979	High performance	US1018H	1.6L L4 1588cc 98 CID	1989-1990	LE, Value Leader	US5045
3.8L V6 3800cc 231 CID	1980	Base, LJ	US1018	1.6L L4 1588cc 98 CID	1991	LE, Value Leader	US5057
3.8L V6 3800cc 231 CID	1980	Base, LJ; High performance	US1018H	1.6L L4 1588cc 98 CID	1992	LE, SE, Value Leader	US5057
3.8L V6 3800cc 231 CID	1981-1983	Base, Brougham, LJ	US1018	1.6L L4 1588cc 98 CID	1993	SE, Value Leader	US5057
3.8L V6 3800cc 231 CID	1981-1983	Base, Brougham, LJ; High performance	US1018H	2.0L L4 122 CID	1989	GSE, LE, SE	US5036
3.8L V6 3800cc 231 CID	1984-1987	Base, Brougham, LE	US1018	2.0L L4 122 CID	1990	GSE	US5036
3.8L V6 3800cc 231 CID	1984-1987	Base, Brougham, LE; High performance	US1018H	3.8L V6 229 CID	1980	Base, Safari	US1121
3.8L V6 3800cc 231 CID	1997-2002	GT, GTP, SE	US5075	3.8L V6 229 CID	1980	Base, Safari; High performance	US1121H
3.8L V6 3800cc 231 CID	2003	GT, GTP	US5075				
3.8L V6 3800cc 231 CID	2004	GT1, GT2, GTP	US5075				
3.8L V6 3800cc 231 CID	2005	Base, GT, GTP	US5075				
3.8L V6 3800cc 231 CID	2006-2007	Base, GT	US5075				
3.8L V6 3800cc 231 CID	2008	Base	US5075				
4.1L V6 252 CID	1982	Base, Brougham, LJ	US1018				
4.1L V6 252 CID	1982	Base, Brougham, LJ; High performance	US1018H				
4.3L V6 262 CID	1986-1987	Base, Brougham, LE	US1121				
4.3L V6 262 CID	1986-1987	Base, Brougham, LE; High performance	US1121H				
4.3L V8 265 CID	1980	Base, LJ	US975				
4.3L V8 265 CID	1981	Base, Brougham, LJ	US975				
4.9L V8 301 CID	1977-1979		US975				
4.9L V8 301 CID	1980	Base, LJ, SJ	US975				
5.0L V8 305 CID	1978-1979		US1121				
5.0L V8 305 CID	1978-1979	High performance	US1121H				
5.0L V8 305 CID	1980	Base, LJ, SJ	US1121				
5.0L V8 305 CID	1980	Base, LJ, SJ; High performance	US1121H				
5.0L V8 305 CID	1983	Base, Brougham, LJ	US1121				

WATER PUMPS

Engine	Years	Application Description	USMW	Engine	Years	Application Description	USMW
<b>PONTIAC (cont'd.)</b>				<b>PONTIAC (cont'd.)</b>			
<b>LEMANS (cont'd.)</b>				<b>SAFARI (cont'd.)</b>			
3.8L V6 231 CID	1977		US1018	5.0L V8 307 CID	1987-1989	Base; High performance	US1120H
3.8L V6 231 CID	1977	High performance	US1018H	<b>SOLSTICE</b>			
3.8L V6 231 CID	1979		US1018	2.0L L4 1998cc 122 CID	2007-2009	GXP	US5092
3.8L V6 231 CID	1979	High performance	US1018H	2.4L L4 2384cc 145 CID	2006-2009	Base	US5092
3.8L V6 3800cc 231 CID	1978-1979		US1018	<b>STAR CHIEF</b>			
3.8L V6 3800cc 231 CID	1978-1979	High performance	US1018H	6.4L V8 6376cc 389 CID	1959-1966		US850
3.8L V6 3800cc 231 CID	1980	Base, Safari; High performance	US1018H	6.9L V8 6900cc 421 CID	1963-1966		US850
3.8L V6 3800cc 231 CID	1980-1981	Base, Safari	US1018	<b>SUNBIRD</b>			
3.8L V6 3800cc 231 CID	1981	High performance	US1018H	1.8L L4 112 CID	1986	Base, GT, SE	US5017
4.1L L6 250 CID	1974	With A/C	US927	2.0L L4 122 CID	1986	SE	US5007
4.1L L6 250 CID	1975-1977		US1107	2.0L L4 122 CID	1987-1988	Base, GT, SE	US5036
4.3L V8 260 CID	1976	Exc.Air Cond	US1100	2.0L L4 122 CID	1989-1990	GT, LE, SE	US5036
4.3L V8 260 CID	1976	Air Cond	US1120	2.0L L4 122 CID	1991	LE, SE, Value Leader	US5036
4.3L V8 260 CID	1976	Air Cond, High performance	US1120H	2.0L L4 122 CID	1992-1993	LE Value Leader, SE	US5036
4.3L V8 265 CID	1980-1981	Base, Safari	US975	2.0L L4 122 CID	1994	LE	US5036
4.9L V8 301 CID	1977		US975	2.5L L4 2474cc 151 CID	1977-1979		US1107
4.9L V8 301 CID	1979		US975	2.5L L4 2474cc 151 CID	1980	Base	US1107
4.9L V8 301 CID	1980	Base, Safari	US975	3.1L V6 189 CID	1991	GT, LE, SE	US5033
4.9L V8 301 CID	1981	Safari	US975	3.1L V6 189 CID	1992	GT, SE	US5033
5.0L V8 305 CID	1977-1979		US1121	3.1L V6 189 CID	1993	GT, LE Value Leader, SE	US5033
5.0L V8 305 CID	1977-1979	High performance	US1121H	3.1L V6 189 CID	1994	GT, LE, SE	US5033
5.0L V8 305 CID	1980	Base, Safari	US1121	3.8L V6 231 CID	1976	High performance	US1018
5.0L V8 305 CID	1980	Base, Safari; High performance	US1121H	3.8L V6 231 CID	1976		US1018H
5.7L V8 350 CID	1968		US850	3.8L V6 3800cc 231 CID	1977-1979	High performance	US1018H
5.7L V8 350 CID	1975-1976		US975	3.8L V6 3800cc 231 CID	1980	Base	US1018
5.7L V8 350 CID	1975-1979	Exc.Air Cond	US1100	3.8L V6 3800cc 231 CID	1980	Base; High performance	US1018H
5.7L V8 350 CID	1975-1979	Air Cond	US1120	5.0L V8 305 CID	1978		US1121
5.7L V8 350 CID	1975-1979	Air Cond, High performance	US1120H	5.0L V8 305 CID	1978-1979	High performance	US1121H
5.7L V8 350 CID	1977-1979	High performance	US1121H	5.0L V8 305 CID	1979		US1069
5.7L V8 5733cc 350 CID	1968		US850	<b>SUNFIRE</b>			
6.6L V8 400 CID	1968		US850	2.2L L4 2190cc 134 CID	1995-2001	SE	US5032
6.6L V8 400 CID	1975-1977		US975	2.2L L4 2190cc 134 CID	2002	GT, SE	US5032
6.6L V8 400 CID	1975-1977	Exc.Air Cond	US1100	2.2L L4 2198cc 134 CID	2002-2003	GT, SE	US5092
6.6L V8 400 CID	1975-1977	Air Cond	US1120	2.2L L4 2198cc 134 CID	2004	SE	US5092
6.6L V8 400 CID	1975-1977	Air Cond, High performance	US1120H	2.2L L4 2198cc 134 CID	2005	Base	US5092
6.6L V8 403 CID	1977		US975	2.3L L4 138 CID	1995	GT, SE	US5043
6.6L V8 403 CID	1977	Exc.Air Cond	US1100	2.4L L4 2392cc 146 CID	1996-2002	GT, SE	US5076
6.6L V8 403 CID	1977	Air Cond	US1120	<b>T1000</b>			
6.6L V8 403 CID	1977	Air Cond, High performance	US1120H	1.6L L4 98 CID	1981-1987	Base	US5004
6.6L V8 403 CID	1977		US975	<b>TEMPEST</b>			
6.6L V8 403 CID	1977	Exc.Air Cond	US1100	5.7L V8 5733cc 350 CID	1968		US850
6.6L V8 403 CID	1977	Air Cond	US1120	6.4L V8 6376cc 389 CID	1961		US850
6.6L V8 403 CID	1977	Air Cond, High performance	US1120H	6.6L V8 6555cc 400 CID	1968		US850
6.6L V8 6555cc 400 CID	1968		US850	<b>TORRENT</b>			
7.5L V8 455 CID	1976		US975	3.4L V6 207 CID	2006-2009	Base	US6145
<b>MATIZ</b>				3.6L V6 3564cc 217 CID	2008-2009	GXP	US8932
1.0L L4 995cc 61 CID	2004-2010		US8928	<b>TRANS SPORT</b>			
<b>MONTANA</b>				3.1L V6 189 CID	1990-1995	Base	US5033
3.4L V6 207 CID	1999-2005	Base	US5033	3.4L V6 207 CID	1996-1997	Base	US5033
3.5L V6 213 CID	2005-2006	SV6	US5033	3.4L V6 207 CID	1998	Base, Montana	US5033
3.9L V6 3880cc 237 CID	2006	SV6	US6020	3.8L V6 3800cc 231 CID	1992-1995	Base	US5050
3.9L V6 3880cc 237 CID	2007-2009	Mexican Application	US6020	<b>VENTURA</b>			
3.9L V6 3880cc 237 CID	2007-2009		US8928	2.5L L4 2474cc 151 CID	1977		US1107
<b>PARISIENNE</b>				3.8L V6 231 CID	1977	High performance	US1018H
3.8L V6 3800cc 231 CID	1984	Base, Brougham	US1018	4.1L L6 250 CID	1974	With A/C	US927
3.8L V6 3800cc 231 CID	1984	Base, Brougham; High performance	US1018H	4.1L L6 250 CID	1975-1976		US1107
4.3L V6 262 CID	1985-1986	Base, Brougham	US1121	4.3L V8 260 CID	1975-1976	Exc.Air Cond	US1100
4.3L V6 262 CID	1985-1986	Base, Brougham; High performance	US1121H	4.3L V8 260 CID	1975-1976	Air Cond	US1120
5.0L V8 305 CID	1983-1986	Base, Brougham	US1121	4.3L V8 260 CID	1975-1976	Air Cond, High performance	US1120H
5.0L V8 305 CID	1983-1986	Base, Brougham; High performance	US1121H	4.9L V8 301 CID	1977		US975
5.0L V8 307 CID	1986	Base, Brougham	US1120	5.0L V8 305 CID	1977		US1121
5.0L V8 307 CID	1986	Base, Brougham; High performance	US1120H	5.0L V8 305 CID	1977	High performance	US1121H
5.7L V8 350 CID	1983-1985	Base, Brougham	US1120	5.7L V8 350 CID	1975-1976	High performance	US1018H
5.7L V8 350 CID	1983-1985	Base, Brougham; High performance	US1120H	5.7L V8 350 CID	1977	Exc.Air Cond	US1100
<b>PHOENIX</b>				5.7L V8 350 CID	1977	Air Cond	US1120
2.5L L4 2474cc 151 CID	1977-1978		US1107	5.7L V8 350 CID	1977	Exc.Air Cond	US1100
2.5L L4 2474cc 151 CID	1980-1983	Base, LJ	US5000	5.7L V8 350 CID	1977	Air Cond, High performance	US1120H
2.5L L4 2474cc 151 CID	1980-1983	Base, LJ; Includes pulley	US5000P	5.7L V8 350 CID	1977	High performance	US1121H
2.5L L4 2474cc 151 CID	1984	Base, LE	US5000	6.4L V8 6376cc 389 CID	1960-1961		US850
2.5L L4 2474cc 151 CID	1984	Base, LE; Includes pulley	US5000P	6.9L V8 6900cc 421 CID	1961		US850
2.8L V6 173 CID	1980-1981	Base, LJ	US5001	<b>VIBE</b>			
2.8L V6 173 CID	1982-1983	Base, LJ, SJ	US5001	1.8L L4 1794cc	2003-2008	Base	US5099
2.8L V6 173 CID	1984	Base, LE, SE	US5001	1.8L L4 1795cc	2003-2006	GT	US9405
3.8L V6 231 CID	1977		US1018	1.8L L4 1798cc	2009	Base	US6232
3.8L V6 231 CID	1977	High performance	US1018H	1.8L L4 1798cc	2010	Base; From 06/01/2009	US6232
3.8L V6 3800cc 231 CID	1978-1979		US1018	1.8L L4 1798cc	2010	Base; To 05/31/2009	US6232
3.8L V6 3800cc 231 CID	1978-1979	High performance	US1018H	2.4L L4 2362cc	2009-2010	AWD, Base, GT	US9414
5.0L V8 305 CID	1977-1978		US1121				
5.0L V8 305 CID	1977-1979	High performance	US1121H				
5.0L V8 305 CID	1979		US1069				
5.7L V8 350 CID	1977-1978		US1121				
5.7L V8 350 CID	1977-1979	Exc.Air Cond	US1100				
5.7L V8 350 CID	1977-1979	Air Cond	US1120				
5.7L V8 350 CID	1977-1979	Air Cond, High performance	US1120H				
5.7L V8 350 CID	1977-1979	High performance	US1121H				
<b>SAFARI</b>							
5.0L V8 307 CID	1987-1989	Base	US1120				

Engine	Years	Application Description	USMW	Engine	Years	Application Description	USMW
<b>PONTIAC (cont'd.)</b>				<b>RAM (cont'd.)</b>			
<b>WAVE</b>				<b>1500 (cont'd.)</b>			
1.6L L4 1598cc 98 CID	2005-2007		US6046	4.7L V8 287 CID	2011	Big Horn, Outdoorsman, SLT, ST	US7163
<b>PORSCHE</b>				4.7L V8 287 CID	2012	Outdoorsman, SLT, ST, Tradesman	US7163
<b>911</b>				4.7L V8 287 CID	2013	SLT, Tradesman	US7163
3.4L H6 3400cc	1999-2001	Carrera, Carrera 4	US9475	5.7L V8 345 CID	2011	Big Horn, Laramie, Laramie Longhorn, Outdoorsman, SLT, Sport, ST, Tradesman	US6341
3.6L H6 3596cc	2002-2003	Carrera, Carrera 4, Carrera 4S	US9475	5.7L V8 345 CID	2012	Big Horn, Express, Laramie, Laramie Longhorn, Outdoorsman, SLT, Sport, ST, Tradesman, Tradesman HD	US6341
3.6L H6 3596cc	2004	40th Anniversary Edition, Carrera, Carrera 4, Carrera 4S	US9475	5.7L V8 345 CID	2013	Big Horn, Express, Laramie, Laramie Longhorn, Outdoorsman, R/T, SLT, Sport, Tradesman	US6341
3.6L H6 3596cc	2005	Carrera, Carrera 4S	US9475	5.7L V8 345 CID	2014	Big Horn, Express, Laramie, Laramie Limited, Laramie Longhorn, Lone Star, Outdoorsman, SLT, Special Service, Sport, Tradesman	US6341
3.6L H6 3596cc	2006	Carrera, Carrera 4	US9475	5.7L V8 345 CID	2015	Big Horn, Express, Laramie, Laramie Limited, Laramie Longhorn, Limited, Lone Star, Outdoorsman, Rebel, SLT, Special Service, Sport, Tradesman	US6341
3.6L H6 3596cc	2007	Carrera, Carrera 4, Targa 4, Turbo	US9475	5.7L V8 345 CID	2016	Big Horn, Express, Laramie, Laramie Longhorn, Limited, Lone Star, Outdoorsman, Rebel, SLT, Special Service, Sport, Tradesman	US6341
3.6L H6 3596cc	2008	Carrera, Carrera 4, GT2, Targa 4, Turbo	US9475	5.7L V8 345 CID	2017	Big Horn, Express, Laramie, Laramie Longhorn, Limited, Lone Star, Rebel, SLT, Special Service, Sport, Tradesman	US6341
3.6L H6 3596cc	2009	GT2, Turbo	US9475	5.7L V8 345 CID	2018	Big Horn, Express, Laramie, Laramie Longhorn, Limited, Lone Star, Rebel, SLT, Special Service, Sport, ST, Tradesman	US6341
3.6L H6 3598cc	2007-2008	GT3, GT3 RS	US9475	<b>2500</b>			
3.6L H6 3600cc 220 CID	2011	GT2 RS	US9475	5.7L V8 345 CID	2011	Laramie, Laramie Longhorn, Power Wagon, SLT, ST	US6341
3.8L H6 3800cc	2010	GT3	US9475	5.7L V8 345 CID	2012	Laramie, Laramie Longhorn, Outdoorsman, Power Wagon, SLT, ST	US6341
3.8L H6 3800cc	2011	GT3, GT3 RS	US9475	5.7L V8 345 CID	2013	Big Horn, Laramie, Laramie Longhorn, Lone Star, Outdoorsman, Power Wagon, SLT, ST, Tradesman	US6341
3.8L H6 3824cc	2005	Carrera S	US9475	5.7L V8 345 CID	2014-2015	Big Horn, Laramie, Laramie Limited, Laramie Longhorn, Lone Star, Outdoorsman, SLT, Tradesman	US6341
3.8L H6 3824cc	2006	Carrera 4S, Carrera S	US9475	5.7L V8 345 CID	2016	Big Horn, Laramie, Laramie Longhorn, Limited, Outdoorsman, SLT, Tradesman	US6341
3.8L H6 3824cc	2007-2008	Carrera 4S, Carrera S, Targa 4S	US9475	5.7L V8 345 CID	2017	Big Horn, Laramie, Laramie Longhorn, Limited, SLT, Tradesman	US6341
4.0L H6 3996cc	2011	GT3 RS 4.0	US9475	5.7L V8 345 CID	2018	Big Horn, Limited, SLT, Tradesman	US6341
<b>924</b>				6.4L V8 6424cc 392 CID	2014-2015	Big Horn, Laramie, Laramie Limited, Laramie Longhorn, Lone Star, Outdoorsman, Power Wagon, SLT, Tradesman	US8140
2.0L L4 1983cc	1977-1979		US9177	6.4L V8 6424cc 392 CID	2016	Big Horn, Laramie, Laramie Longhorn, Limited, Power Wagon, SLT, Tradesman	US8140
2.0L L4 1983cc	1980	Base, Turbo	US9177	6.7L L6 408 CID	2011	Laramie, Laramie Longhorn, SLT, ST	US6222
2.0L L4 1983cc	1981-1982	Base	US9177	6.7L L6 408 CID	2012	Laramie, Laramie Longhorn, Outdoorsman, SLT, ST	US6222
2.5L L4 2475cc	1987-1988	S	US9245	6.7L L6 408 CID	2013	Big Horn, Laramie, Laramie Longhorn, Lone Star, Outdoorsman, SLT, ST, Tradesman	US99
<b>928</b>				6.7L L6 408 CID	2014-2015	Big Horn, Laramie, Laramie Limited, Laramie Longhorn, Lone Star, Outdoorsman, SLT, Tradesman	US99
4.5L V8 4474cc	1978-1979		US9242	6.7L L6 408 CID	2016	Big Horn, Laramie, Laramie Longhorn, Limited, Outdoorsman, SLT, Tradesman	US99
4.5L V8 4474cc	1980-1982	Base	US9242	6.7L L6 408 CID	2017-2018	Big Horn, Laramie, Laramie Longhorn, Limited, Power Wagon, SLT, Tradesman	US8140
4.7L V8 4671cc	1983-1984	S	US9242	6.7L L6 408 CID	2011	Laramie, Laramie Longhorn, SLT, ST	US6222
5.0L V8 4950cc	1985-1986	S	US9242	6.7L L6 408 CID	2012	Laramie, Laramie Longhorn, Outdoorsman, SLT, ST	US6222
5.0L V8 4950cc	1987-1989	S4	US9241	6.7L L6 408 CID	2013	Big Horn, Laramie, Laramie Longhorn, Lone Star, Outdoorsman, SLT, ST, Tradesman	US99
5.0L V8 4950cc	1990-1991	Base, GT	US9241	6.7L L6 408 CID	2014-2015	Big Horn, Laramie, Laramie Limited, Laramie Longhorn, Lone Star, Outdoorsman, SLT, Tradesman	US99
5.4L V8 5392cc	1993-1995	GTS	US9241	6.7L L6 408 CID	2016	Big Horn, Laramie, Laramie Longhorn, Limited, Outdoorsman, SLT, Tradesman	US99
<b>944</b>				6.7L L6 408 CID	2017-2018	Big Horn, Laramie, Laramie Longhorn, Limited, SLT, Tradesman	US99
2.5L L4 2475cc	1983-1985	Base	US9245	<b>3500</b>			
2.5L L4 2475cc	1986	Base, Turbo	US9245	5.7L V8 345 CID	2011-2012	Laramie, SLT, ST	US6341
2.5L L4 2475cc	1987-1988	Base, S, Turbo	US9245	5.7L V8 345 CID	2013	Big Horn, Laramie, Laramie Longhorn, Lone Star, SLT, ST, Tradesman	US6341
2.5L L4 2475cc	1989	Turbo	US9245	5.7L V8 345 CID	2014-2015	Big Horn, Laramie, Laramie Limited, Laramie Longhorn, Lone Star, SLT, Tradesman	US6341
<b>BOXSTER</b>				5.7L V8 345 CID	2016	Big Horn, Laramie, Laramie Longhorn, Limited, SLT, Tradesman	US6341
2.5L H6 2480cc	1997-1999	Base	US9475	5.7L V8 345 CID	2017	Big Horn, Laramie, Laramie Longhorn, Limited, Lone Star, SLT, Tradesman	US6341
2.5L H6 2480cc 151 CID	2000	Mexican Application	US9475	5.7L V8 345 CID	2018	Big Horn, Laramie, Laramie Longhorn, Limited, SLT, Tradesman	US6341
2.7L H6 2687cc	2000-2003	Roadster	US9475	6.4L V8 6424cc 392 CID	2014-2015	Big Horn, Laramie, Laramie Longhorn, Lone Star, SLT, Tradesman	US8140
2.7L H6 2687cc	2004-2007	Base	US9475	6.4L V8 6424cc 392 CID	2016	Big Horn, Laramie, Laramie Longhorn, Limited, Outdoorsman, Power Wagon, SLT, Tradesman	US8140
2.7L H6 2687cc	2008	Base, Limited Edition	US9475	6.4L V8 6424cc 392 CID	2017-2018	Big Horn, Laramie, Laramie Longhorn, Limited, Power Wagon, SLT, Tradesman	US8140
3.2L H6 3179cc	2000-2003	Roadster S	US9475	6.7L L6 408 CID	2011	Laramie, Laramie Longhorn, SLT, ST	US6222
3.2L H6 3179cc	2004	S, S Special Edition	US9475	6.7L L6 408 CID	2012	Laramie, Laramie Longhorn, Outdoorsman, SLT, ST	US6222
3.2L H6 3179cc	2005-2006	S	US9475	6.7L L6 408 CID	2013	Big Horn, Laramie, Laramie Longhorn, Lone Star, Outdoorsman, SLT, ST, Tradesman	US99
3.4L H6 3387cc	2007	S	US9475	6.7L L6 408 CID	2014-2015	Big Horn, Laramie, Laramie Limited, Laramie Longhorn, Lone Star, Outdoorsman, SLT, Tradesman	US99
3.4L H6 3387cc	2008	RS 60 Spyder, S, S Limited Edition	US9475	6.7L L6 408 CID	2016	Big Horn, Laramie, Laramie Longhorn, Limited, Outdoorsman, SLT, Tradesman	US99
<b>CAYENNE</b>				6.7L L6 408 CID	2017-2018	Big Horn, Laramie, Laramie Longhorn, Limited, SLT, Tradesman	US99
3.2L V6 3189cc 195 CID	2004-2006	Base	US9471	<b>1500</b>			
<b>CAYMAN</b>				3.0L V6 2987cc 182 CID	2014	Big Horn, Laramie, Laramie Limited, Laramie Longhorn, Lone Star, Outdoorsman, SLT, Tradesman	US8161
2.7L H6 2687cc	2007-2008	Base	US9475	3.0L V6 2987cc 182 CID	2015	Big Horn, Laramie, Laramie Limited, Laramie Longhorn, Limited, Lone Star, Outdoorsman, SLT, Tradesman	US8161
3.4L H6 3387cc	2006-2008	S	US9475	3.0L V6 2987cc 182 CID	2016	Big Horn, HFE, Laramie, Laramie Longhorn, Limited, Lone Star, Outdoorsman, SLT, Tradesman	US8161
<b>RAM</b>				3.0L V6 2987cc 182 CID	2017	Big Horn, HFE, Laramie, Laramie Longhorn, Limited, Lone Star, SLT, Tradesman	US8161
<b>1500</b>				3.0L V6 2987cc 182 CID	2018	Big Horn, Laramie, Laramie Longhorn, Limited, Lone Star, SLT, ST, Tradesman	US8161
3.0L V6 2987cc 182 CID	2014	Big Horn, Laramie, Laramie Limited, Laramie Longhorn, Lone Star, Outdoorsman, SLT, Tradesman	US8161	3.6L V6 3604cc 220 CID	2013	HFE, Outdoorsman, SLT, Tradesman	US8981
3.0L V6 2987cc 182 CID	2015	Big Horn, Laramie, Laramie Limited, Laramie Longhorn, Limited, Lone Star, Outdoorsman, SLT, Tradesman	US8161	3.6L V6 3604cc 220 CID	2014	Big Horn, Express, HFE, Laramie, Lone Star, Outdoorsman, SLT, Tradesman	US8981
3.0L V6 2987cc 182 CID	2016	Big Horn, HFE, Laramie, Laramie Longhorn, Limited, Lone Star, Outdoorsman, SLT, Tradesman	US8161	3.6L V6 3604cc 220 CID	2015-2016	Big Horn, Express, HFE, Laramie, Lone Star, Outdoorsman, Rebel, SLT, Tradesman	US8981
3.0L V6 2987cc 182 CID	2017	Big Horn, HFE, Laramie, Laramie Longhorn, Limited, Lone Star, SLT, Tradesman	US8161	3.6L V6 3604cc 220 CID	2017	Big Horn, Express, Laramie, Lone Star, Rebel, SLT, Sport, Tradesman	US8981
3.0L V6 2987cc 182 CID	2018	Big Horn, Laramie, Laramie Longhorn, Limited, Lone Star, SLT, ST, Tradesman	US8161	3.6L V6 3604cc 220 CID	2018	Big Horn, Express, Laramie, Lone Star, Rebel, SLT, Sport, ST, Tradesman	US8981
3.6L V6 3604cc 220 CID	2013	HFE, Outdoorsman, SLT, Tradesman	US8981	3.7L V6 226 CID	2011-2012	ST	US7163
3.6L V6 3604cc 220 CID	2014	Big Horn, Express, HFE, Laramie, Lone Star, Outdoorsman, SLT, Tradesman	US8981	<b>3500</b>			
3.6L V6 3604cc 220 CID	2015-2016	Big Horn, Express, HFE, Laramie, Lone Star, Outdoorsman, Rebel, SLT, Tradesman	US8981	5.7L V8 345 CID	2011-2012	Laramie, SLT, ST	US6341
3.6L V6 3604cc 220 CID	2017	Big Horn, Express, Laramie, Lone Star, Rebel, SLT, Sport, Tradesman	US8981	5.7L V8 345 CID	2013	Big Horn, Laramie, Laramie Longhorn, Lone Star, SLT, ST, Tradesman	US6341
3.6L V6 3604cc 220 CID	2018	Big Horn, Express, Laramie, Lone Star, Rebel, SLT, Sport, ST, Tradesman	US8981	5.7L V8 345 CID	2014-2015	Big Horn, Laramie, Laramie Limited, Laramie Longhorn, Lone Star, SLT, Tradesman	US6341
<b>RAM</b>				5.7L V8 345 CID	2016	Big Horn, Laramie, Laramie Longhorn, Limited, SLT, Tradesman	US6341
<b>1500</b>				5.7L V8 345 CID	2017	Big Horn, Laramie, Laramie Longhorn, Limited, Lone Star, SLT, Tradesman	US6341
3.0L V6 2987cc 182 CID	2014	Big Horn, Laramie, Laramie Limited, Laramie Longhorn, Lone Star, Outdoorsman, SLT, Tradesman	US8161	5.7L V8 345 CID	2018	Big Horn, Laramie, Laramie Longhorn, Limited, SLT, Tradesman	US6341
3.0L V6 2987cc 182 CID	2015	Big Horn, Laramie, Laramie Limited, Laramie Longhorn, Limited, Lone Star, Outdoorsman, SLT, Tradesman	US8161	6.4L V8 6424cc 392 CID	2014-2015	Big Horn, Laramie, Laramie Longhorn, Lone Star, SLT, Tradesman	US8140
3.0L V6 2987cc 182 CID	2016	Big Horn, HFE, Laramie, Laramie Longhorn, Limited, Lone Star, Outdoorsman, SLT, Tradesman	US8161	6.4L V8 6424cc 392 CID	2016	Big Horn, Laramie, Laramie Longhorn, Limited, SLT, Tradesman	US8140
3.0L V6 2987cc 182 CID	2017	Big Horn, HFE, Laramie, Laramie Longhorn, Limited, Lone Star, SLT, Tradesman	US8161	6.4L V8 6424cc 392 CID	2017	Big Horn, Laramie, Laramie Longhorn, Limited, Lone Star, SLT, Tradesman	US8140
3.0L V6 2987cc 182 CID	2018	Big Horn, Laramie, Laramie Longhorn, Limited, Lone Star, SLT, ST, Tradesman	US8161	6.4L V8 6424cc 392 CID	2018	Big Horn, Laramie, Laramie Longhorn, Limited, SLT, Tradesman	US8140
3.6L V6 3604cc 220 CID	2013	HFE, Outdoorsman, SLT, Tradesman	US8981	6.7L L6 408 CID	2011-2012	Laramie, Laramie Longhorn, SLT, ST	US6222
3.6L V6 3604cc 220 CID	2014	Big Horn, Express, HFE, Laramie, Lone Star, Outdoorsman, SLT, Tradesman	US8981	6.7L L6 408 CID	2013	Big Horn, Laramie, Laramie Longhorn, Lone Star, SLT, ST, Tradesman	US99
3.6L V6 3604cc 220 CID	2015-2016	Big Horn, Express, HFE, Laramie, Lone Star, Outdoorsman, Rebel, SLT, Tradesman	US8981	<b>WATER PUMPS</b>			
3.6L V6 3604cc 220 CID	2017	Big Horn, Express, Laramie, Lone Star, Rebel, SLT, Sport, Tradesman	US8981				
3.6L V6 3604cc 220 CID	2018	Big Horn, Express, Laramie, Lone Star, Rebel, SLT, Sport, ST, Tradesman	US8981				
3.7L V6 226 CID	2011-2012	ST	US7163				





# WATER PUMP APPLICATION GUIDE



Engine	Years	Application Description	USMW	Engine	Years	Application Description	USMW
<b>RAM (cont'd.)</b>				<b>RENAULT (cont'd.)</b>			
<b>3500 (cont'd.)</b>				<b>R5 (cont'd.)</b>			
6.7L L6 408 CID	2014-2015	Big Horn, Laramie, Laramie Limited, Laramie Longhorn, Lone Star, SLT, Tradesman	US99	1.3L L4 1289cc 79 CID	1981	Base, Mirage L, Mirage S	US9301
6.7L L6 408 CID	2016	Big Horn, Laramie, Laramie Longhorn, Limited, SLT, Tradesman	US99	1.3L L4 1289cc 79 CID	1982-1983	Mirage	US9282
6.7L L6 408 CID	2017	Big Horn, Laramie, Laramie Longhorn, Limited, Lone Star, SLT, Tradesman	US99	1.3L L4 1289cc 79 CID	1982-1983	Base, Mirage	US9301
6.7L L6 408 CID	2018	Big Horn, Laramie, Laramie Longhorn, Limited, SLT, Tradesman	US99	1.3L L4 1300cc 79 CID	1977-1984	Mexican Application	US9282
<b>4500</b>				<b>R8S</b>			
6.4L V8 6424cc 392 CID	2014-2016	Laramie, SLT, Tradesman	US8140	1.3L L4 1300cc 79 CID	1968-1975	Mexican Application	US9282
6.4L V8 6424cc 392 CID	2017	Base	US8140	<b>R10</b>			
6.7L L6 408 CID	2011-2012	Laramie, SLT, ST	US6222	1.3L L4 1300cc 79 CID	1967-1972	Mexican Application	US9282
6.7L L6 408 CID	2013	Laramie, SLT, ST, Tradesman	US99	<b>R12</b>			
6.7L L6 408 CID	2014-2016	Laramie, SLT, Tradesman	US99	1.3L L4 1289cc 79 CID	1980-1982		US9282
6.7L L6 408 CID	2017-2018	Base	US99	1.3L L4 1300cc 79 CID	1971-1983	Mexican Application	US9282
<b>5500</b>				1.6L L4 1600cc 98 CID	1975-1980	Mexican Application	US3406
6.4L V8 6424cc 392 CID	2014-2016	Laramie, SLT, Tradesman	US8140	1.6L L4 1647cc 100 CID	1975-1979	TS	US3406
6.4L V8 6424cc 392 CID	2017	Base	US8140	<b>R18</b>			
6.7L L6 408 CID	2011-2012	Laramie, SLT, ST	US6222	1.6L L4 1600cc 98 CID	1980	Mexican Application	US3406
6.7L L6 408 CID	2013	Laramie, SLT, ST, Tradesman	US99	1.6L L4 1600cc 98 CID	1984	Mexican Application	US3406
6.7L L6 408 CID	2014-2016	Laramie, SLT, Tradesman	US99	2.0L L4 1995cc 122 CID	1984-1986	Mexican Application	US8914
6.7L L6 408 CID	2017-2018	Base	US99	<b>R18i</b>			
<b>C/V</b>				1.6L L4 1647cc 100 CID	1981-1982	Base, Deluxe	US3406
3.6L V6 3604cc 220 CID	2012-2014	Base	US8981	1.6L L4 1647cc 100 CID	1983	Deluxe	US3406
3.6L V6 3604cc 220 CID	2015	Base, Tradesman	US8981	2.2L L4 2152cc 131 CID	1984-1986	Sportwagon	US3410
<b>DAKOTA</b>				<b>SANDERO</b>			
3.7L V6 226 CID	2011	Big Horn, Laramie, SLT, ST	US7163	1.6L L4 1598cc 97 CID	2010-2011	Mexican Application	US8927
4.7L V8 287 CID	2011	Big Horn, Laramie, SLT, TRX4	US7163	1.6L L4 1598cc 98 CID	2010-2011	Authentique	US8927
<b>PROMASTER 1500</b>				<b>SCENIC</b>			
3.6L V6 3604cc 220 CID	2014-2018	Base	US8981	2.0L L4 1998cc 122 CID	2003-2004	Mexican Application	US8914
<b>PROMASTER 2500</b>				2.0L L4 2000cc 122 CID	2002	Mexican Application	US8914
3.6L V6 3604cc 220 CID	2014-2018	Base	US8981	<b>SCENIC II</b>			
<b>PROMASTER 3500</b>				2.0L L4 1998cc 122 CID	2005-2008	Mexican Application	US8914
3.6L V6 3604cc 220 CID	2014-2018	Base	US8981	<b>TRAFIC</b>			
<b>PROMASTER CITY</b>				1.9L L4 1870cc 114 CID	2008-2012		US8921
2.4L L4 2360cc 144 CID	2015-2018	Base, SLT, Tradesman, Tradesman SLT	US6038	1.9L L4 1900cc 114 CID	2007-2012	Mexican Application	US8921
<b>RENAULT</b>				<b>ROVER</b>			
<b>ALLIANCE</b>				<b>75</b>			
1.7L L4 105 CID	1985	DL, L, Limited	US3408	2.5L V6 2497cc 152 CID	2000		US9496
1.7L L4 105 CID	1986	Base, DL, L	US3408	2.5L V6 2497cc 152 CID	2003-2005		US9496
1.7L L4 105 CID	1987	Base, DL, GS, L	US3408	<b>SAAB</b>			
<b>CLIO</b>				<b>9-2X</b>			
1.6L L4 1598cc 97 CID	2003-2010	Mexican Application	US8927	2.0L H4 1994cc	2005	Aero	US9215
1.6L L4 1598cc 98 CID	2002-2010		US8927	2.5L H4 2458cc	2005	Linear	US9223
1.6L L4 1600cc 98 CID	2002	Mexican Application	US8927	2.5L H4 2458cc	2006	Aero	US9215
2.0L L4 1998cc 122 CID	2003-2006	Mexican Application	US8914	2.5L H4 2458cc	2006	2.5i	US9223
2.0L L4 2000cc 122 CID	2002	Mexican Application	US8914	<b>9-3</b>			
<b>ENCORE</b>				2.0L L4 1985cc	1999-2001	Base, SE	US9307
1.7L L4 105 CID	1985	GS, LS, S	US3408	2.0L L4 1985cc	2002-2003	SE	US9307
1.7L L4 105 CID	1986	Electronic, GS, LS, S	US3408	2.0L L4 1985cc	2003	Arc, Linear, Vector	US5092
<b>FUEGO</b>				2.0L L4 1985cc	2004-2005	Aero, Arc, Linear	US5092
1.6L L4 1565cc	1982-1984	Turbo	US3406	2.0L L4 1985cc	2006-2009	2.0T	US5092
1.6L L4 1647cc 100 CID	1982-1983	Base	US3410	2.0L L4 1985cc	2010	2.0T, Aero	US5092
2.2L L4 2152cc 131 CID	1984-1985	Base	US3410	2.0L L4 1985cc	2011	Aero, Turbo4	US5092
<b>KANGOO</b>				2.3L L4 2290cc 140 CID	1999-2002	Viggen	US9307
1.6L L4 1598cc 97 CID	2004-2010	Mexican Application	US8927	2.8L V6 2792cc 170 CID	2006	Aero; From Chassis/VIN 61112756	US8932
1.6L L4 1598cc 98 CID	2007-2009		US8927	2.8L V6 2792cc 170 CID	2006	Aero; To Chassis/VIN 61112755	US8932
<b>KANGOO EXPRESS</b>				2.8L V6 2792cc 170 CID	2007	Aero	US8932
1.6L L4 1598cc 98 CID	2004-2008		US8927	2.8L V6 2792cc 170 CID	2008	Aero, Aero XWD, Turbo X	US8932
1.6L L4 1598cc 98 CID	2010		US8927	2.8L V6 2792cc 170 CID	2009	Aero, Aero XWD	US8932
<b>LAGUNA</b>				<b>9-3X</b>			
3.0L V6 2950cc 180 CID	2003-2005	Mexican Application	US8973	2.0L L4 1985cc	2010-2011	Base	US5092
<b>MEGANE</b>				<b>9-5</b>			
2.0L L4 1998cc 122 CID	2003-2004	Mexican Application	US8914	2.3L L4 2290cc 140 CID	1999	Base, SE	US9307
2.0L L4 2000cc 122 CID	2001-2002	Mexican Application	US8914	2.3L L4 2290cc 140 CID	2000	2.3t, Aero, Gary Fisher	US9307
<b>MEGANE II</b>				2.3L L4 2290cc 140 CID	2001	2.3t, Aero	US9307
1.6L L4 1598cc 97 CID	2008-2010	Mexican Application	US8927	2.3L L4 2290cc 140 CID	2002-2003	Aero, Linear	US9307
2.0L L4 1998cc 122 CID	2004-2010	Mexican Application	US8914	2.3L L4 2290cc 140 CID	2004-2005	Aero, Arc, Linear	US9307
<b>R5</b>				2.3L L4 2290cc 140 CID	2006-2007	2.3t	US9307
1.3L L4 1289cc 79 CID	1979		US9282	2.3L L4 2290cc 140 CID	2008-2009	2.3t, Aero	US9307
1.3L L4 1289cc 79 CID	1979		US9301	2.8L V6 2792cc 170 CID	2010	Aero	US8932
1.3L L4 1289cc 79 CID	1980		US9282	2.8L V6 2792cc 170 CID	2011	Aero, Turbo6	US8932
1.3L L4 1289cc 79 CID	1980	Mirage	US9301	3.0L V6 2961cc 181 CID	1999-2001	SE	US5079
1.3L L4 1289cc 79 CID	1981	Base, Mirage	US9282	3.0L V6 2961cc 181 CID	2002-2003	Arc	US5079
<b>RENAULT (cont'd.)</b>				<b>9-7X</b>			
<b>R5 (cont'd.)</b>				4.2L L6 256 CID	2005	Linear	US5097
1.3L L4 1289cc 79 CID	1981	Base, Mirage L, Mirage S	US9301	4.2L L6 256 CID	2006-2009	4.2i	US5097
1.3L L4 1289cc 79 CID	1982-1983	Mirage	US9282	5.3L V8 5328cc 325 CID	2005	Arc	US64
1.3L L4 1289cc 79 CID	1982-1983	Base, Mirage	US9301	5.3L V8 5328cc 325 CID	2005	Arc; Includes thermostat and thermostat housing	US64-T
1.3L L4 1300cc 79 CID	1977-1984	Mexican Application	US9282				
<b>R8S</b>							
1.3L L4 1300cc 79 CID	1968-1975	Mexican Application	US9282				
<b>R10</b>							
1.3L L4 1300cc 79 CID	1967-1972	Mexican Application	US9282				
<b>R12</b>							
1.3L L4 1289cc 79 CID	1980-1982		US9282				
1.3L L4 1300cc 79 CID	1971-1983	Mexican Application	US9282				
1.6L L4 1600cc 98 CID	1975-1980	Mexican Application	US3406				
1.6L L4 1647cc 100 CID	1975-1979	TS	US3406				
<b>R18</b>							
1.6L L4 1600cc 98 CID	1980	Mexican Application	US3406				
1.6L L4 1600cc 98 CID	1984	Mexican Application	US3406				
2.0L L4 1995cc 122 CID	1984-1986	Mexican Application	US8914				
<b>R18i</b>							
1.6L L4 1647cc 100 CID	1981-1982	Base, Deluxe	US3406				
1.6L L4 1647cc 100 CID	1983	Deluxe	US3406				
2.2L L4 2152cc 131 CID	1984-1986	Sportwagon	US3410				
<b>SANDERO</b>							
1.6L L4 1598cc 97 CID	2010-2011	Mexican Application	US8927				
1.6L L4 1598cc 98 CID	2010-2011	Authentique	US8927				
<b>SCENIC</b>							
2.0L L4 1998cc 122 CID	2003-2004	Mexican Application	US8914				
2.0L L4 2000cc 122 CID	2002	Mexican Application	US8914				
<b>SCENIC II</b>							
2.0L L4 1998cc 122 CID	2005-2008	Mexican Application	US8914				
<b>TRAFIC</b>							
1.9L L4 1870cc 114 CID	2008-2012		US8921				
1.9L L4 1900cc 114 CID	2007-2012	Mexican Application	US8921				
<b>ROVER</b>							
<b>75</b>							
2.5L V6 2497cc 152 CID	2000		US9496				
2.5L V6 2497cc 152 CID	2003-2005		US9496				
<b>SAAB</b>							
<b>9-2X</b>							
2.0L H4 1994cc	2005	Aero	US9215				
2.5L H4 2458cc	2005	Linear	US9223				
2.5L H4 2458cc	2006	Aero	US9215				
2.5L H4 2458cc	2006	2.5i	US9223				
<b>9-3</b>							
2.0L L4 1985cc	1999-2001	Base, SE	US9307				
2.0L L4 1985cc	2002-2003	SE	US9307				
2.0L L4 1985cc	2003	Arc, Linear, Vector	US5092				
2.0L L4 1985cc	2004-2005	Aero, Arc, Linear	US5092				
2.0L L4 1985cc	2006-2009	2.0T	US5092				
2.0L L4 1985cc	2010	2.0T, Aero	US5092				
2.0L L4 1985cc	2011	Aero, Turbo4	US5092				
2.3L L4 2290cc 140 CID	1999-2002	Viggen	US9307				
2.8L V6 2792cc 170 CID	2006	Aero; From Chassis/VIN 61112756	US8932				
2.8L V6 2792cc 170 CID	2006	Aero; To Chassis/VIN 61112755	US8932				
2.8L V6 2792cc 170 CID	2007	Aero	US8932				
2.8L V6 2792cc 170 CID	2008	Aero, Aero XWD, Turbo X	US8932				
2.8L V6 2792cc 170 CID	2009	Aero, Aero XWD	US8932				
<b>9-3X</b>							
2.0L L4 1985cc	2010-2011	Base	US5092				
<b>9-5</b>							
2.3L L4 2290cc 140 CID	1999	Base, SE	US9307				
2.3L L4 2290cc 140 CID	2000	2.3t, Aero, Gary Fisher	US9307				
2.3L L4 2290cc 140 CID	2001	2.3t, Aero	US9307				
2.3L L4 2290cc 140 CID	2002-2003	Aero, Linear	US9307				
2.3L L4 2290cc 140 CID	2004-2005	Aero, Arc, Linear	US9307				
2.3L L4 2290cc 140 CID	2006-2007	2.3t	US9307				
2.3L L4 2290cc 140 CID	2008-2009	2.3t, Aero	US9307				
2.8L V6 2792cc 170 CID	2010	Aero	US8932				
2.8L V6 2792cc 170 CID	2011	Aero, Turbo6	US8932				
3.0L V6 2961cc 181 CID	1999-2001	SE	US5079				
3.0L V6 2961cc 181 CID	2002-2003	Arc	US5079				
<b>9-7X</b>							
4.2L L6 256 CID	2005	Linear	US5097				
4.2L L6 256 CID	2006-2009	4.2i	US5097				
5.3L V8 5328cc 325 CID	2005	Arc	US64				
5.3L V8 5328cc 325 CID	2005	Arc; Includes thermostat and thermostat housing	US64-T				

Engine	Years	Application Description	USMW	Engine	Years	Application Description	USMW
<b>SAAB (cont'd.)</b>				<b>SATURN (cont'd.)</b>			
<b>9-7X (cont'd.)</b>				<b>LW300</b>			
5.3L V8 5328cc 325 CID	2006	5.3i	US64	3.0L V6 3000cc 181 CID	2001-2003	Base	US5079
5.3L V8 5328cc 325 CID	2006	5.3i; Includes thermostat and thermostat housing	US64-T	<b>OUTLOOK</b>			
5.3L V8 5328cc 325 CID	2007-2009	5.3i	US6009	3.6L V6 3564cc 217 CID	2007-2010	XE, XR	US8932
5.3L V8 5328cc 325 CID	2007-2009	5.3i; Includes thermostat and thermostat housing	US6009-T	<b>RELAY</b>			
6.0L V8 5967cc 364 CID	2008-2009	Aero	US6009	3.5L V6 213 CID	2005-2006	2, 3	US5033
6.0L V8 5967cc 364 CID	2008-2009	Aero; Includes thermostat and thermostat housing	US6009-T	3.9L V6 3880cc 237 CID	2006	3	US6020
<b>900</b>				3.9L V6 3880cc 237 CID	2007	1, 2, 3	US6020
2.0L L4 1985cc	1981-1985	Base, S, Turbo	US9108	<b>SC</b>			
2.0L L4 1985cc	1986-1990	Base, S, SPG, Turbo	US9108	1.9L L4 116 CID	1991-1992	Base	US5054
2.0L L4 1985cc	1991	SE Turbo, SPG, S Turbo	US9108	<b>SC1</b>			
2.0L L4 1985cc	1992	Turbo	US9108	1.9L L4 116 CID	1993-2002	Base	US5054
2.0L L4 1985cc	1993	Turbo, Turbo Commemorative Edition	US9108	<b>SC2</b>			
2.0L L4 1985cc	1994	SE Turbo, Turbo, Turbo Commemorative Edition	US9307	1.9L L4 116 CID	1993-2002	Base	US5054
2.0L L4 1985cc	1995-1997	SE Turbo	US9307	<b>SKY</b>			
2.0L L4 1985cc	1998	SE Turbo, S Turbo	US9307	2.0L L4 1998cc 122 CID	2007-2010	Red Line	US5092
2.1L L4 2119cc	1991-1992	Base, S	US9108	2.4L L4 2384cc 145 CID	2007-2010	Base	US5092
2.1L L4 2119cc	1993-1994	S	US9108	<b>SL</b>			
2.3L L4 2290cc 140 CID	1994-1998	S	US9307	1.9L L4 116 CID	1991-2002	Base	US5054
2.5L V6 2498cc	1994-1997	SE	US5079	<b>SL1</b>			
<b>9000</b>				1.9L L4 116 CID	1991-2002	Base	US5054
2.0L L4 1985cc	1986	Turbo	US9107	<b>SL2</b>			
2.0L L4 1985cc	1987-1988	S, Turbo	US9107	1.9L L4 116 CID	1991-2002	Base	US5054
2.0L L4 1985cc	1989	Base, CD, S	US9107	<b>SW1</b>			
2.0L L4 1985cc	1990	CD, S, Turbo	US9107	1.9L L4 116 CID	1993-1999	Base	US5054
2.3L L4 2290cc	1991	CD Turbo, Turbo	US9264	<b>SW2</b>			
2.3L L4 2290cc	1992	CD Griffin Edition, CD Turbo, Turbo	US9264	1.9L L4 116 CID	1993-2001	Base	US5054
2.3L L4 2290cc	1993	Aero, CDE Turbo, CD Turbo, CSE Turbo, CS Turbo	US9264	<b>VUE</b>			
2.3L L4 2290cc	1994	Aero, CDE Turbo, CSE Turbo, CS Turbo	US9264	2.2L L4 2198cc 134 CID	2002-2007	Base	US5092
2.3L L4 2290cc	1995-1997	Aero, CS, CSE Turbo	US9264	2.4L L4 2384cc 145 CID	2007	Green Line	US5092
2.3L L4 2290cc	1998	CSE Turbo	US9264	2.4L L4 2384cc 145 CID	2008	Green Line, XE	US5092
2.3L L4 2290cc 140 CID	1990	S	US9264	2.4L L4 2384cc 145 CID	2009	Hybrid, XE, XR	US5092
2.3L L4 2290cc 140 CID	1991-1992	Base, CD, S	US9264	2.4L L4 2384cc 145 CID	2010	XE	US5092
2.3L L4 2290cc 140 CID	1993	CD, CDE, CS, CSE	US9264	3.0L V6 3000cc 181 CID	2002-2003	Base	US5079
2.3L L4 2290cc 140 CID	1994	CDE, CS, CSE	US9264	3.5L V6 3471cc	2006-2007	Base, Red Line	US9470
3.0L V6 2961cc 181 CID	1995	CDE, CSE	US5079	3.5L V6 3474cc	2004	Red Line	US9470
3.0L V6 2961cc 181 CID	1996-1997	CSE	US5079	3.5L V6 3474cc	2005	Base, Red Line	US9470
<b>SATURN</b>				3.5L V6 3475cc	2004	Base	US9470
<b>ASTRA</b>				3.5L V6 3490cc 213 CID	2008-2009	XE	US6020
1.8L L4 1796cc 110 CID	2008	XE, XR	US6184	3.6L V6 3564cc 217 CID	2008-2009	Red Line, XR	US8932
<b>AURA</b>				3.6L V6 3564cc 217 CID	2010	XR	US8932
2.4L L4 2384cc 145 CID	2007	Green Line	US5092	<b>SCION</b>			
2.4L L4 2384cc 145 CID	2008	Green Line, XE	US5092	<b>FR-S</b>			
2.4L L4 2384cc 145 CID	2009	Hybrid, XE, XR	US5092	2.0L H4 1998cc 122 CID	2013-2016	Base	US9384
3.5L V6 3490cc 213 CID	2007-2008	XE	US6020	<b>IA</b>			
3.6L V6 3564cc 217 CID	2007-2009	XR	US8932	1.5L L4 1496cc 91 CID	2016	Base	US6700
<b>ION</b>				<b>TC</b>			
2.0L L4 122 CID	2004-2007	Red Line	US5092	2.4L L4 2362cc	2010	Base	US9414
2.2L L4 2198cc 134 CID	2003-2005	1, 2, 3	US5092	2.4L L4 2398cc	2005-2006	Base	US9414
2.2L L4 2198cc 134 CID	2006-2007	2, 3	US5092	2.4L L4 2398cc	2007-2008	Base, Spec	US9414
2.4L L4 2384cc 145 CID	2006-2007	3	US5092	2.4L L4 2398cc	2009	Base	US9414
<b>L100</b>				2.5L L4 2494cc 152 CID	2011-2016	Base	US6252
2.2L L4 2198cc 134 CID	2001-2002	Base	US5092	<b>XA</b>			
<b>L200</b>				1.5L L4 1497cc	2004-2006	Base	US9406
2.2L L4 2198cc 134 CID	2001-2003	Base	US5092	<b>XB</b>			
<b>L300</b>				1.5L L4 1497cc	2004-2006	Base	US9406
2.2L L4 2198cc 134 CID	2004	1	US5092	2.4L L4 2362cc	2008-2010	Base	US8970
3.0L V6 3000cc 181 CID	2001-2003	Base	US5079	2.4L L4 2362cc	2011	Base; To 11/2010	US8970
3.0L V6 3000cc 181 CID	2004	2, 3	US5079	2.4L L4 2362cc	2011	Base; Engine # 0XXXXXX-6XXXXXX, Engine # BXXXXXX, Engine # HXXXXXX-KXXXXXX, From 11/2010	US9414
3.0L V6 3000cc 181 CID	2005	Base	US5079	2.4L L4 2362cc	2011-2014	Base; Engine # CXXXXXX-GXXXXXX, From 11/2010	US8970
<b>LS</b>				2.4L L4 2362cc	2012-2015	Base; Engine # 0XXXXXX-6XXXXXX, Engine # BXXXXXX, Engine # HXXXXXX-KXXXXXX	US9414
2.2L L4 2198cc 134 CID	2000	Base	US5092	2.4L L4 2362cc	2014	Base; From 11/2010 (Engine # CXXXXXX-GXXXXXX)	US8970
<b>LS1</b>				2.4L L4 2362cc	2014-2015	Base; Engine # 0XXXXXX-6XXXXXX (Engine # BXXXXXX) (Engine # HXXXXXX-KXXXXXX)	US9414
2.2L L4 2198cc 134 CID	2000	Base	US5092	2.4L L4 2362cc	2015	Base; Engine # CXXXXXX-GXXXXXX	US8970
<b>LS2</b>				<b>XD</b>			
3.0L V6 3000cc 181 CID	2000	Base	US5079	1.8L L4 1798cc	2008-2014	Base	US6232
<b>LW1</b>							
2.2L L4 2198cc 134 CID	2000	Base	US5092				
<b>LW2</b>							
3.0L V6 3000cc 181 CID	2000	Base	US5079				
<b>LW200</b>							
2.2L L4 2198cc 134 CID	2001-2003	Base	US5092				

WATER PUMPS

Engine	Years	Application Description	USMW	Engine	Years	Application Description	USMW
<b>SEAT</b>				<b>SUBARU (cont'd.)</b>			
<b>ALHAMBRA</b>				<b>FORESTER</b>			
1.8L L4 1781cc 108 CID	2002-2003	Mexican Application	<b>US9377</b>	2.5L H4 2458cc	1998-2001	Base, L, S	<b>US9223</b>
1.8L L4 1781cc 109 CID	2004-2007	Mexican Application	<b>US9377</b>	2.5L H4 2458cc	2002	Base, L, S; Standard Trans	<b>US9223</b>
1.8L L4 1798cc 110 CID	2003	Mexican Application	<b>US9377</b>	2.5L H4 2458cc	2002	Base, L, S; Automatic Trans	<b>US9472</b>
2.8L V6 2792cc 170 CID	2002-2005	Mexican Application	<b>US9262</b>	2.5L H4 2458cc	2003-2005	X, XS; Standard Trans	<b>US9223</b>
2.8L V6 2792cc 170 CID	2007-2008	Mexican Application	<b>US9262</b>	2.5L H4 2458cc	2003-2005	X, XS; Automatic Trans	<b>US9472</b>
<b>ALTEA</b>				2.5L H4 2458cc	2004	XT	<b>US9215</b>
2.0L L4 1984cc 121 CID	2005-2006	Mexican Application	<b>US9377</b>	2.5L H4 2458cc	2005	XT, XT Premium	<b>US9215</b>
2.0L L4 1984cc 121 CID	2008-2009	Mexican Application	<b>US9377</b>	2.5L H4 2458cc	2005	XS L.L. Bean Edition	<b>US9472</b>
<b>CORDOBA</b>				2.5L H4 2458cc	2006	X; Standard Trans	<b>US6049</b>
1.6L L4 1600cc 98 CID	2001-2002	Mexican Application	<b>US8959</b>	2.5L H4 2458cc	2006	X; Automatic Trans	<b>US6160</b>
1.6L L4 1600cc 98 CID	2004-2006	Mexican Application	<b>US8949</b>	2.5L H4 2458cc	2006	X L.L. Bean Edition	<b>US6160</b>
1.6L L4 1600cc 98 CID	2007	Mexican Application	<b>US9378</b>	2.5L H4 2458cc	2006-2007	XT Limited	<b>US9215</b>
1.6L L4 1600cc 98 CID	2008-2009	Mexican Application	<b>US8949</b>	2.5L H4 2458cc	2007	X, X L.L. Bean Edition	<b>US6049</b>
2.0L L4 1984cc 121 CID	2003-2009	Mexican Application	<b>US9377</b>	2.5L H4 2458cc	2008	Sports 2.5 X, X, X L.L. Bean Edition	<b>US6049</b>
<b>FREETRACK</b>				2.5L H4 2458cc	2008	Sports 2.5 XT, XT Limited	<b>US9255</b>
2.0L L4 1998cc 122 CID	2009	Mexican Application	<b>US9377</b>	2.5L H4 2458cc	2009	XT, XT Limited	<b>US9255</b>
<b>IBIZA</b>				2.5L H4 2458cc	2009-2010	X, X Limited, X Premium	<b>US6049</b>
1.4L L4 1390cc 85 CID	2012-2013	Mexican Application	<b>US8952</b>	2.5L H4 2458cc	2010	XT Limited, XT Premium	<b>US9255</b>
1.4L L4 1390cc 85 CID	2015	Mexican Application	<b>US8952</b>	2.5L H4 2458cc	2011-2013	XT Premium, XT Touring	<b>US9255</b>
1.6L L4 1600cc 98 CID	2001	Mexican Application	<b>US9378</b>	2.5L H4 2498cc 152 CID	2011-2013	X, X Limited, X Premium, X Touring; (FB25BA)	<b>US9384</b>
1.6L L4 1600cc 98 CID	2002	Mexican Application	<b>US8959</b>	2.5L H4 2498cc 152 CID	2011-2013	X, X Limited, X Premium, X Touring; (FB25BC)	<b>US9384</b>
1.6L L4 1600cc 98 CID	2004	Mexican Application	<b>US9378</b>	2.5L H4 2498cc 152 CID	2014-2015	2.5i, 2.5i Limited, 2.5i Premium, 2.5i Touring; (FB25BA)	<b>US9384</b>
1.6L L4 1600cc 98 CID	2005-2009	Mexican Application	<b>US8949</b>	2.5L H4 2498cc 152 CID	2014-2015	2.5i, 2.5i Limited, 2.5i Premium, 2.5i Touring; (FB25BC)	<b>US9384</b>
1.6L L4 1600cc 98 CID	2010	Mexican Application	<b>US8996</b>	2.5L L4 2457cc 150 CID	2010	Mexican Application	<b>US9215</b>
1.6L L4 1600cc 98 CID	2006-2008	Mexican Application	<b>US9377</b>	2.5L L4 2498cc 152 CID	2014	Mexican Application	<b>US9384</b>
1.8L L4 1798cc 110 CID	2005	Mexican Application	<b>US9377</b>	<b>GL</b>			
2.0L L4 1984cc 121 CID	2003-2012	Mexican Application	<b>US9377</b>	1.6L H4 1595cc	1980	Base	<b>US9025</b>
<b>LEON</b>				1.6L H4 1595cc	1986-1987	Base	<b>US9025</b>
1.4L L4 1368cc 83 CID	2008-2009	Mexican Application	<b>US8949</b>	1.8L H4 1781cc	1980-1983	Base	<b>US9025</b>
1.4L L4 1390cc 85 CID	2008	Mexican Application	<b>US8949</b>	1.8L H4 1781cc	1984	Base, Turbo	<b>US9025</b>
1.4L L4 1390cc 85 CID	2010	Mexican Application	<b>US8976</b>	1.8L H4 1781cc	1985-1986	Base, Turbo; With air cond.	<b>US9080</b>
1.4L L4 1390cc 85 CID	2010-2014	Mexican Application	<b>US8952</b>	1.8L H4 1781cc	1985-1986	Base, Turbo; Exc. air cond.	<b>US9161</b>
1.8L L4 1781cc 108 CID	2001-2003	Mexican Application	<b>US9377</b>	1.8L H4 1781cc	1987	Base; With air cond.	<b>US9080</b>
1.8L L4 1781cc 109 CID	2004-2006	Mexican Application	<b>US9377</b>	1.8L H4 1781cc	1987	Base; Exc. air cond.	<b>US9161</b>
1.8L L4 1798cc 110 CID	2009-2010	Mexican Application	<b>US9377</b>	1.8L H4 1781cc	1988-1989	Base, Turbo; With air cond.	<b>US9080</b>
2.0L L4 1984cc 121 CID	2007	Mexican Application	<b>US9377</b>	1.8L H4 1781cc	1988-1989	Base, Turbo; Exc. air cond.	<b>US9161</b>
2.0L L4 1984cc 121 CID	2010	Mexican Application	<b>US9377</b>	<b>GL-10</b>			
2.0L L4 1998cc 122 CID	2008-2009	Mexican Application	<b>US9377</b>	1.8L H4 1781cc	1985	Base; With air cond.	<b>US9080</b>
2.0L L4 2000cc 122 CID	2006-2007	Mexican Application	<b>US9377</b>	1.8L H4 1781cc	1985	Base; Exc. air cond.	<b>US9161</b>
<b>TOLEDO</b>				1.8L H4 1781cc	1986-1989	Base, Turbo; With air cond.	<b>US9080</b>
1.4L L4 1390cc 85 CID	2013	Mexican Application	<b>US8952</b>	1.8L H4 1781cc	1986-1989	Base, Turbo; Exc. air cond.	<b>US9161</b>
1.4L L4 1390cc 85 CID	2015-2016	Mexican Application	<b>US8952</b>	<b>GLF</b>			
1.8L L4 1781cc 108 CID	2001-2003	Mexican Application	<b>US9377</b>	1.6L H4 1595cc	1980	Base	<b>US9025</b>
1.8L L4 1781cc 109 CID	2003-2005	Mexican Application	<b>US9377</b>	1.8L H4 1781cc	1980-1982	Base	<b>US9025</b>
1.8L L4 1798cc 110 CID	2004	Mexican Application	<b>US9377</b>	<b>IMPREZA</b>			
2.0L L4 1984cc 121 CID	2006	Mexican Application	<b>US9377</b>	1.8L H4 1781cc	1993-1994	Base, L, LS	<b>US9223</b>
<b>SMART</b>				1.8L H4 1781cc	1995	Base, L, Outback	<b>US9223</b>
<b>FORTWO</b>				1.8L H4 1781cc	1996	Brighton, L	<b>US9223</b>
1.0L L3 1000cc 61 CID	2008	Passion, Passion Cabrio, Pure	<b>US8121</b>	1.8L H4 1781cc	1997	Brighton	<b>US9223</b>
1.0L L3 1000cc 61 CID	2009-2010	Brabus, Passion, Passion Cabrio, Pure	<b>US8121</b>	2.0L H4 1994cc	2002-2005	WRX	<b>US9215</b>
1.0L L3 1000cc 61 CID	2011-2015	Passion, Passion Cabrio, Pure	<b>US8121</b>	2.0L H4 1995cc	2012-2015	Base, Limited, Premium, Sport Limited, Sport Premium	<b>US9384</b>
<b>STERLING</b>				2.0L L4 1983cc 121 CID	2008-2009	Mexican Application	<b>US9223</b>
<b>825</b>				2.2L H4 2212cc	1995	L, LX, Outback	<b>US9223</b>
2.5L V6 2494cc	1987-1988	S, SL	<b>US9097</b>	2.2L H4 2212cc	1996	L, Outback	<b>US9223</b>
<b>827</b>				2.2L H4 2212cc	1997	Brighton, L, Outback	<b>US9223</b>
2.7L V6 2675cc	1989-1990	S, SL, SLi	<b>US9097</b>	2.2L H4 2212cc	1998-2001	L, Outback	<b>US9223</b>
<b>SUBARU</b>				2.5L H4 2458cc	1998-2001	RS	<b>US9223</b>
<b>B9 TRIBECA</b>				2.5L H4 2458cc	2002-2004	Outback, RS, TS	<b>US9223</b>
3.0L H6 3000cc	2006-2007	Base, Limited	<b>US9421</b>	2.5L H4 2458cc	2004-2005	WRX STI	<b>US9215</b>
<b>BAJA</b>				2.5L H4 2458cc	2005	Outback Sport, RS	<b>US9223</b>
2.5L H4 2458cc	2003	Base, Sport	<b>US9223</b>	2.5L H4 2458cc	2006	WRX, WRX Limited, WRX STI, WRX TR	<b>US9215</b>
2.5L H4 2458cc	2004-2006	Turbo	<b>US9215</b>	2.5L H4 2458cc	2006-2009	2.5i, Outback Sport	<b>US6049</b>
2.5L H4 2458cc	2004-2006	Sport	<b>US9223</b>	2.5L H4 2458cc	2007	WRX, WRX Limited, WRX STI, WRX STI Limited, WRX TR	<b>US9215</b>
<b>BRAT</b>				2.5L H4 2458cc	2008	WRX	<b>US9255</b>
1.6L H4 1595cc	1980	DL, GL	<b>US9025</b>	2.5L H4 2458cc	2008-2009	WRX STI	<b>US9215</b>
1.8L H4 1781cc	1980-1983	DL, GL	<b>US9025</b>	2.5L H4 2458cc	2009	2.5 GT, WRX, WRX Premium	<b>US9255</b>
1.8L H4 1781cc	1984	GL Turbo	<b>US9093</b>	2.5L H4 2458cc	2010	WRX STI, WRX STI Special Edition	<b>US9215</b>
1.8L H4 1781cc	1984-1987	GL	<b>US9025</b>	2.5L H4 2458cc	2010	2.5 GT, WRX, WRX Limited, WRX Premium	<b>US9255</b>
<b>BRZ</b>				2.5L H4 2458cc	2010-2011	2.5i, 2.5i Premium, Outback Sport	<b>US6049</b>
2.0L H4 1998cc 122 CID	2013-2014	Limited, Premium	<b>US9384</b>	2.5L H4 2458cc	2011-2014	WRX STI, WRX STI Limited	<b>US9215</b>
2.0L H4 1998cc 122 CID	2015	Limited, Premium, Series.Blue	<b>US9384</b>	2.5L H4 2458cc	2011-2014	WRX, WRX Limited, WRX Premium	<b>US9255</b>
<b>DL</b>				2.5L L4 2457cc 150 CID	2010	Mexican Application	<b>US9215</b>
1.6L H4 1595cc	1980-1984	Base	<b>US9025</b>	2.5L L4 2457cc 150 CID	2010-2011	Mexican Application	<b>US6049</b>
1.8L H4 1781cc	1980-1984	Base	<b>US9025</b>	<b>JUSTY</b>			
1.8L H4 1781cc	1985-1989	Base; With air cond.	<b>US9080</b>	1.2L L3 1189cc	1987-1988	DL, GL; Cover	<b>US9486</b>
1.8L H4 1781cc	1985-1989	Base; Exc. air cond.	<b>US9161</b>	1.2L L3 1189cc	1987-1988	DL, GL; Impeller Set	<b>US9486</b>
				1.2L L3 1189cc	1989	DL, GL, RS; Cover	<b>US9486</b>



Engine	Years	Application Description	USMW	Engine	Years	Application Description	USMW
<b>SUBARU (cont'd.)</b>				<b>SUBARU (cont'd.)</b>			
<b>JUSTY (cont'd.)</b>				<b>RX</b>			
1.2L L3 1189cc	1989	DL, GL, RS; Impeller Set	US9486	1.8L H4 1781cc	1986-1989	Turbo; With air cond.	US9080
1.2L L3 1189cc	1990	DL, GL; Cover	US9486	1.8L H4 1781cc	1986-1989	Turbo; Exc. air cond.	US9161
1.2L L3 1189cc	1990	DL, GL; Impeller Set	US9486	<b>STANDARD</b>			
1.2L L3 1189cc	1991-1993	GL; Cover	US9486	1.6L H4 1595cc	1980-1987	Base	US9025
1.2L L3 1189cc	1991-1993	GL; Impeller Set	US9486	1.8L H4 1781cc	1981-1982	Base	US9025
1.2L L3 1189cc	1994	DL, GL; Cover	US9486	<b>SVX</b>			
1.2L L3 1189cc	1994	DL, GL; Impeller Set	US9486	3.3L H6 3318cc	1992	LS, LSL	US9254
<b>LEGACY</b>				3.3L H6 3318cc	1993	LSL	US9254
2.0L L4 1987cc 122 CID	2008	Mexican Application	US9223	3.3L H6 3318cc	1994-1995	L, LS, LSi	US9254
2.2L H4 2212cc	1990	Base, L, LS	US9223	3.3L H6 3318cc	1996-1997	L, LSi	US9254
2.2L H4 2212cc	1991-1993	L, LS, LSi	US9223	<b>TRIBECA</b>			
2.2L H4 2212cc	1991-1994	Sport	US9255	3.6L H6 3630cc	2008-2009	Base, Limited	US6692
2.2L H4 2212cc	1994	Alpine Sport, GT, L, LS, LSi, Outdoor, Sun Sport, Touring	US9223	3.6L H6 3630cc	2010-2012	Limited, Premium, Touring	US6692
2.2L H4 2212cc	1995	Base, Brighton, L, LS, LSi, Outback, Postal	US9223	3.6L H6 3630cc	2013-2014	Limited	US6692
2.2L H4 2212cc	1996	Brighton, L, LS, Outback, Postal	US9223	<b>WRX</b>			
2.2L H4 2212cc	1997	Brighton, L, Postal; From 03/1997	US9223	2.5L L4 2457cc 150 CID	2012-2014	Mexican Application	US9215
2.2L H4 2212cc	1997	Brighton, L, Postal; To 02/1997	US9223	<b>WRX STI</b>			
2.2L H4 2212cc	1998	Brighton, L, Postal	US9223	2.5L H4 2458cc	2015	Base, Launch Edition, Limited	US9215
2.2L H4 2212cc	1999	Brighton, L, L 30th Anniversary, Limited 30th Anniversary	US9223	<b>XT</b>			
2.5L H4 2458cc	1996	GT, LSi, Outback	US9223	1.8L H4 1781cc	1985-1986	DL, GL, GL-10 Turbo	US9080
2.5L H4 2458cc	1997	GT, LSi, Outback, Outback Limited; From 03/1997	US9223	1.8L H4 1781cc	1987	DL, GL, GL-10, GL-10 Turbo	US9080
2.5L H4 2458cc	1997	GT, LSi, Outback, Outback Limited; To 02/1997	US9223	1.8L H4 1781cc	1988	DL, GL	US9080
2.5L H4 2458cc	1998	GT, GT Limited, Outback	US9223	1.8L H4 1781cc	1989-1991	GL	US9080
2.5L H4 2458cc	1998	GT, Limited 30th Anniversary, Outback, Outback Limited, SUS 30th Anniversary	US9223	2.7L H6 2672cc	1988-1991	XT6	US9109
2.5L H4 2458cc	1999	Brighton, GT, GT Limited, L	US9223	<b>XV CROSSTREK</b>			
2.5L H4 2458cc	2001-2002	GT, GT Limited, L	US9223	2.0L H4 1995cc	2013-2014	Limited, Premium	US9384
2.5L H4 2458cc	2003	GT, L, L SE	US9223	2.0L H4 1995cc	2015	Base, Limited, Premium	US9384
2.5L H4 2458cc	2004	GT, L, L 35th Anniversary	US9223	<b>SUZUKI</b>			
2.5L H4 2458cc	2005	GT, GT Limited	US9215	<b>AERIO</b>			
2.5L H4 2458cc	2005	i, Limited	US9223	2.0L L4 2000cc	2002-2003	GS, S, SX	US9342
2.5L H4 2458cc	2006	2.5i	US6049	2.3L L4 2290cc 140 CID	2004-2005	LX, S, SX	US9342
2.5L H4 2458cc	2006	GT, GT spec.B	US9215	2.3L L4 2290cc 140 CID	2006	Base, Premium, SX, SX Premium	US9342
2.5L H4 2458cc	2007-2009	2.5i, 2.5i Limited, 2.5i Special Edition	US6049	2.3L L4 2290cc 140 CID	2007	Base, Premium	US9342
2.5L H4 2458cc	2007-2009	GT Limited, GT spec.B	US9215	<b>EQUATOR</b>			
2.5L H4 2458cc	2010-2012	2.5i, 2.5i Limited, 2.5i Premium	US6049	4.0L V6 3954cc	2009	Base, RMZ-4, Sport	US9426
2.5L H4 2458cc	2010-2012	2.5GT	US8139	4.0L V6 3954cc	2010-2012	RMZ-4, Sport	US9426
2.5L H4 2498cc 152 CID	2013	2.5i, 2.5i Limited, 2.5i Premium	US9384	<b>ESTEEM</b>			
2.5L H4 2498cc 152 CID	2014	2.5i, 2.5i Limited, 2.5i Premium, 2.5i Sport	US9384	1.6L L4 1590cc 97 CID	1995-1996	GL, GLX, GLX Plus	US5048
2.5L H4 2498cc 152 CID	2015	2.5i, 2.5i Limited, 2.5i Premium	US9384	1.6L L4 1590cc 97 CID	1997-2000	GL, GLX, GLX Plus	US9374
2.5L L4 2457cc 150 CID	2011-2013	Mexican Application	US6049	1.8L L4 1790cc	1999-2002	GL, GLX, GLX Plus	US9342
2.5L L4 2457cc 150 CID	2013	Mexican Application	US9215	<b>FORENZA</b>			
3.0L H6 3000cc	2008	3.0 R Limited	US9421	2.0L L4 2000cc	2004-2005	EX, LX, S	US8925
3.0L H6 3000cc	2009	3.0 R, 3.0 R Limited	US9421	2.0L L4 2000cc	2006	Base, Premium	US8925
3.6L H6 3630cc	2010-2012	3.6R, 3.6R Limited, 3.6R Premium	US6692	2.0L L4 2000cc	2007-2008	Base	US8925
3.6L H6 3630cc	2013	3.6R, 3.6R Limited	US6692	<b>GRAND VITARA</b>			
3.6L H6 3630cc	2014-2015	3.6R Limited	US6692	2.4L L4 2393cc	2009	Base, Luxury, Premium, XSport	US6292
3.6L H6 3630cc 222 CID	2014	Mexican Application	US9421	2.4L L4 2393cc	2010	Base, Limited, Premium, XSport	US6292
<b>LOYALE</b>				2.4L L4 2393cc	2011	Base, Limited, Premium	US6292
1.8L H4 1781cc	1990	Base, RS, RS Turbo, Turbo	US9161	2.4L L4 2393cc	2012	Base, Limited, Premium, Ultimate Adventure Edition	US6292
1.8L H4 1781cc	1991-1994	Base	US9161	2.4L L4 2393cc	2013	Base, Limited, Premium	US6292
<b>OUTBACK</b>				2.4L L4 2393cc 146 CID	2010-2015	Mexican Application	US6292
2.5L H4 2458cc	2000-2004	Base, Limited	US9223	2.5L V6 2500cc	1999	JLX, JLX Plus, JS, JS Plus	US9385
2.5L H4 2458cc	2005	XT, XT Limited	US9215	2.5L V6 2500cc	2000	JLS, JLS Plus, JLX, JLX Plus, Limited	US9385
2.5L H4 2458cc	2005	i, Limited	US9223	2.5L V6 2500cc	2001	JLS, JLS Plus, JLS Plus SE, JLX, JLX Plus, JLX Plus SE, Limited	US9385
2.5L H4 2458cc	2006	2.5i, 2.5i Limited	US6049	2.5L V6 2500cc	2002	JLS, JLX, Limited	US9385
2.5L H4 2458cc	2006	XT	US9215	2.5L V6 2500cc	2003	Base	US9385
2.5L H4 2458cc	2007	2.5i, 2.5i Basic, 2.5i Limited	US6049	2.5L V6 2500cc	2004-2005	EX, LX	US9385
2.5L H4 2458cc	2007-2009	XT Limited	US9215	2.7L V6 2737cc	2001	XL-7, XL-7 Limited, XL-7 Plus, XL-7 Touring	US9385
2.5L H4 2458cc	2008	2.5i, 2.5i L.L. Bean Edition, 2.5i Limited, 2.5i Limited L.L. Bean Edition, Base	US6049	2.7L V6 2737cc	2006	Base, Luxury, Premium, XSport	US9385
2.5L H4 2458cc	2009	2.5i, 2.5i Limited	US6049	2.7L V6 2737cc	2007-2008	Base, Luxury, XSport	US9385
2.5L H4 2458cc	2010-2012	2.5i, 2.5i Limited, 2.5i Premium	US6049	3.2L V6 3195cc	2009	Luxury, XSport	US8932
2.5L H4 2498cc 152 CID	2013-2015	2.5i, 2.5i Limited, 2.5i Premium	US9384	3.2L V6 3195cc	2010	Limited, XSport	US8932
2.5L L4 2457cc 150 CID	2013	Mexican Application	US6049	<b>KIZASHI</b>			
3.0L H6 3000cc	2001	L.L. Bean, VDC	US9421	2.4L L4 2388cc 146 CID	2010	GTS, S, SE, SLS	US6292
3.0L H6 3000cc	2002-2003	H6, L.L. Bean, VDC	US9421	2.4L L4 2388cc 146 CID	2011-2012	S, SE, Sport GTS, Sport SLS	US6292
3.0L H6 3000cc	2004	H6, H6 35th Anniversary Edition, H6 VDC, L.L. Bean	US9421	2.4L L4 2388cc 146 CID	2013	Base, GTS, SE, SLS	US6292
3.0L H6 3000cc	2005	R, R L.L. Bean Edition, VDC Limited	US9421	<b>RENO</b>			
3.0L H6 3000cc	2006	R, R L.L. Bean Edition, R VDC Limited	US9421	2.0L L4 1998cc	2005	EX, LX, S	US8925
3.0L H6 3000cc	2007-2008	R L.L. Bean Edition	US9421	2.0L L4 1998cc	2006	Base, Convenience, Premium	US8925
3.0L H6 3000cc	2009	3.0 R Limited	US9421	2.0L L4 1998cc	2007	Base	US8925
3.6L H6 3630cc	2010-2012	3.6R, 3.6R Limited, 3.6R Premium	US6692	2.0L L4 1998cc 122 CID	2008	Base	US8925
3.6L H6 3630cc	2013	3.6R, 3.6R Limited	US6692	<b>SAMURAI</b>			
3.6L H6 3630cc	2014-2015	3.6R Limited	US6692	1.3L L4 1298cc 79 CID	1990	JL	US5029
3.6L H6 3630cc 222 CID	2014	Mexican Application	US9421	1.3L L4 1298cc 79 CID	1991	JA, JL, JS	US5029

WATER PUMPS

Engine	Years	Application Description	USMW	Engine	Years	Application Description	USMW
<b>SUZUKI (cont'd.)</b>				<b>TOYOTA (cont'd.)</b>			
<b>SAMURAI (cont'd.)</b>				<b>86</b>			
1.3L L4 1298cc 79 CID	1992-1993	JA, JL	<b>US5029</b>	2.0L H4 1998cc 122 CID	2017	Base, Special Edition	<b>US9384</b>
1.3L L4 1298cc 79 CID	1994-1995	JL	<b>US5029</b>	<b>AVALON</b>			
1.3L L4 1325cc 81 CID	1986-1987	JA, JX, JX SE	<b>US5029</b>	2.5L L4 2494cc 152 CID	2014	Hybrid Limited, Hybrid XLE	<b>US6211</b>
1.3L L4 1325cc 81 CID	1988	JA, JX	<b>US5029</b>	2.5L L4 2494cc 152 CID	2015	Hybrid Limited, Hybrid XLE Premium, Hybrid XLE Touring	<b>US6211</b>
1.3L L4 1325cc 81 CID	1989	Base	<b>US5029</b>	2.5L L4 2494cc 152 CID	2016-2017	Hybrid Limited, Hybrid XLE Plus, Hybrid XLE Premium	<b>US6211</b>
<b>SIDEKICK</b>				3.0L V6 2995cc	1995	XL, XLS	<b>US9306</b>
1.3L L4 1325cc 81 CID	1989	JA	<b>US5029</b>	3.0L V6 2995cc	1996	XL	<b>US9306</b>
1.6L L4 1590cc 97 CID	1989	JLX, JX	<b>US5048</b>	3.0L V6 2995cc	1997-2004	XL, XLS	<b>US9306</b>
1.6L L4 1590cc 97 CID	1990	JLX, JS, JX	<b>US5048</b>	3.5L V6 3456cc	2005-2008	Limited, Touring, XL, XLS	<b>US6047</b>
1.6L L4 1590cc 97 CID	1991	JL, JLX, JS, JX	<b>US5048</b>	3.5L V6 3456cc	2009-2010	Limited, XL, XLS	<b>US6047</b>
1.6L L4 1590cc 97 CID	1992	JLX, JS, JX	<b>US5048</b>	3.5L V6 3456cc	2011	Base, Limited, XLS	<b>US6047</b>
1.6L L4 1590cc 97 CID	1993	Base, JLX, JS, JX	<b>US5048</b>	3.5L V6 3456cc	2012	Base, Limited	<b>US6047</b>
1.6L L4 1590cc 97 CID	1994-1995	JLX, JS, JX	<b>US5048</b>	3.5L V6 3456cc	2013-2014	Limited, XLE	<b>US6047</b>
1.6L L4 1590cc 97 CID	1996-1998	JS, JX	<b>US5048</b>	3.5L V6 3456cc	2015	Limited, XLE, XLE Premium, XLE Touring, XLE Touring SE	<b>US6047</b>
1.8L L4 1840cc	1996	JLX Sport, JX Sport	<b>US9342</b>	3.5L V6 3456cc	2016-2017	Limited, Touring, XLE, XLE Plus, XLE Premium	<b>US6047</b>
1.8L L4 1840cc	1997-1998	JLX Sport, JS Sport, JX Sport	<b>US9342</b>	<b>AVANZA</b>			
<b>SJ410</b>				<b>CAMRY</b>			
1.0L L3 993cc 61 CID	1982	To Vin# F10A548473	<b>US9227</b>	1.8L L4 1839cc	1984-1986	DLX	<b>US9059</b>
1.0L L3 993cc 61 CID	1982	From Vin# F10A548474	<b>US9232</b>	2.0L L4 1974cc	1986	DLX	<b>US9059</b>
1.0L L4 970cc 59 CID	1983-1984	To Vin# F10A548473	<b>US9227</b>	2.0L L4 1995cc	1983-1986	DLX, LE	<b>US9048</b>
1.0L L4 970cc 59 CID	1983-1984	From Vin# F10A548474	<b>US9232</b>	2.0L L4 1998cc 122 CID	1987	DLX, LE; Pump only	<b>US9099</b>
<b>SWIFT</b>				2.0L L4 1998cc 122 CID	1987	DLX, LE; Includes back housing	<b>US9099-2</b>
1.3L L4 1298cc 79 CID	1989	GLX, GTI	<b>US5058</b>	2.0L L4 1998cc 122 CID	1988-1991	Base, DLX, DLX All Trac, LE, LE All Trac; Pump only	<b>US9099</b>
1.3L L4 1298cc 79 CID	1990	GA, GL, GLX, GS, GT, S	<b>US5058</b>	2.0L L4 1998cc 122 CID	1988-1991	Base, DLX, DLX All Trac, LE, LE All Trac; Includes back housing	<b>US9099-2</b>
1.3L L4 1298cc 79 CID	1991-1994	GA, GS, GT	<b>US5058</b>	2.2L L4 2164cc	1992	DLX, LE, XLE; Pump only	<b>US9099</b>
1.3L L4 1298cc 79 CID	1995-1999	Base	<b>US5058</b>	2.2L L4 2164cc	1992	DLX, LE, XLE; Includes back housing	<b>US9099-2</b>
1.3L L4 1298cc 79 CID	2000-2001	GA, GL	<b>US5058</b>	2.2L L4 2164cc	1993-1996	DX, LE, XLE; Pump only	<b>US9099</b>
1.5L L4 1500cc 92 CID	2007-2009	Mexican Application	<b>US9374</b>	2.2L L4 2164cc	1993-1996	DX, LE, XLE; Includes back housing	<b>US9099-2</b>
<b>SX4</b>				2.2L L4 2164cc	1997-2001	CE, LE, XLE; Pump only	<b>US9099</b>
2.0L L4 1995cc	2007-2009	Base, Sport	<b>US9342</b>	2.2L L4 2164cc	1997-2001	CE, LE, XLE; Includes back housing	<b>US9099-2</b>
2.0L L4 1995cc	2010	Base, Crossover, LE, Sportback, Sport GTS, Sport S, Sport SE	<b>US6292</b>	2.4L L4 2362cc	2002-2004	LE, SE, XLE; Exc.Japan Built Part	<b>US9414</b>
2.0L L4 1995cc	2011	Crossover, LE, LE Anniversary Edition, Sportback, Sport GTS, Sport S, Sport SE	<b>US6292</b>	2.4L L4 2362cc	2002-2004	LE, SE, XLE; Japan Built Part	<b>US9414</b>
2.0L L4 1995cc	2012-2013	Crossover, LE, Sportback, Sport SE	<b>US6292</b>	2.4L L4 2362cc	2005-2006	Base, LE, SE, XLE; Exc.Japan Built Part	<b>US9414</b>
<b>VERONA</b>				2.4L L4 2362cc	2005-2006	Base, LE, SE, XLE; Japan Built Part	<b>US9414</b>
2.5L L6 2492cc	2004-2005	EX, LX, S	<b>US6241</b>	2.4L L4 2362cc	2007-2008	CE, LE, SE, XLE; Exc.Japan Built Part	<b>US9414</b>
2.5L L6 2492cc	2006	Base, Luxury	<b>US6241</b>	2.4L L4 2362cc	2007-2008	CE, LE, SE, XLE; Japan Built Part	<b>US9414</b>
<b>VITARA</b>				2.4L L4 2362cc	2007-2008	Hybrid; Exc.Japan Built, Exc.Japan Built Part	<b>US9414</b>
1.6L L4 1590cc 97 CID	1999	JS, JS Plus, JX, JX Plus	<b>US9374</b>	2.4L L4 2362cc	2007-2008	Hybrid; Exc.Japan Built, Japan Built Part	<b>US9414</b>
1.6L L4 1590cc 97 CID	2000-2001	JLS, JLX, JS, JX	<b>US9374</b>	2.4L L4 2362cc	2007-2008	Hybrid; Exc.Japan Built, Japan Built Part	<b>US9414</b>
2.0L L4 2000cc	1999	JS, JS Plus, JX, JX Plus	<b>US9342</b>	2.4L L4 2362cc	2007-2008	Hybrid; Exc.Japan Built, Japan Built Part	<b>US9414</b>
2.0L L4 2000cc	2000-2001	JLS, JLX, JS, JX	<b>US9342</b>	2.4L L4 2362cc	2007-2011	Hybrid; Japan Built	<b>US9414</b>
2.0L L4 2000cc	2002	JLS, JLX	<b>US9342</b>	2.4L L4 2362cc	2007-2011	Hybrid; ELECTRIC/GAS; HVAC System	<b>US11012</b>
2.0L L4 2000cc	2003	Base	<b>US9342</b>	2.4L L4 2362cc	2009	Base, LE, SE, XLE; Exc.Japan Built Part	<b>US9414</b>
2.5L V6 2500cc	2004	LX	<b>US9385</b>	2.4L L4 2362cc	2009	Base, LE, SE, XLE; Japan Built Part	<b>US9414</b>
<b>X-90</b>				2.4L L4 2362cc	2009	Hybrid; Exc.Japan Built, From 03/2009	<b>US9414</b>
1.6L L4 1590cc 97 CID	1996-1997	Base	<b>US5048</b>	2.4L L4 2362cc	2009	Hybrid; Exc.Japan Built, Japan Built Part, To 03/2009	<b>US9414</b>
1.6L L4 1590cc 97 CID	1998	Base, SE	<b>US5048</b>	2.4L L4 2362cc	2009	Hybrid; Exc.Japan Built, Japan Built Part, To 03/2009	<b>US9414</b>
<b>XL-7</b>				2.4L L4 2362cc	2010-2011	Hybrid; Exc.Japan Built	<b>US9414</b>
2.7L V6 2737cc	2002	Base, Limited, Plus, Touring	<b>US9385</b>	2.4L L4 2362cc	2010-2011	Hybrid; Exc.Japan Built	<b>US9414</b>
2.7L V6 2737cc	2003	Limited, Touring	<b>US9385</b>	2.5L L4 2494cc 152 CID	2010-2011	LE, SE, XLE; Engine Serial # Starts With 0 or 6, Exc.Japan Built	<b>US6252</b>
2.7L V6 2737cc	2004-2005	EX, LX	<b>US9385</b>	2.5L L4 2494cc 152 CID	2010-2011	LE, SE, XLE; Engine Serial # Starts With A or D, Exc.Japan Built	<b>US6252</b>
2.7L V6 2737cc	2006	Base, Premium	<b>US9385</b>	2.5L L4 2494cc 152 CID	2010-2011	LE, SE, XLE; Japan Built	<b>US6252</b>
3.6L V6 3564cc	2007	Base, Limited, Luxury	<b>US8932</b>	2.5L L4 2494cc 152 CID	2012-2013	L, LE, SE, XLE	<b>US6252</b>
3.6L V6 3564cc	2008	Base, Limited, Luxury, Premium	<b>US8932</b>	2.5L L4 2494cc 152 CID	2014	L, LE, SE, SE Sport, XLE	<b>US6252</b>
3.6L V6 3564cc	2009	Limited, Luxury, Premium	<b>US8932</b>	2.5L L4 2494cc 152 CID	2014-2017	Hybrid LE, Hybrid SE, Hybrid XLE	<b>US6211</b>
<b>TOYOTA</b>				2.5L L4 2494cc 152 CID	2015	LE, SE, XLE, XSE	<b>US6252</b>
<b>4RUNNER</b>				2.5L L4 2494cc 152 CID	2016	LE, SE, Special Edition, XLE, XSE	<b>US6252</b>
2.4L L4 2366cc	1984	DLX, SR5	<b>US9017</b>	2.5L L4 2494cc 152 CID	2017	LE, SE, XLE, XSE	<b>US6252</b>
2.4L L4 2366cc	1985-1989	DLX, SR5	<b>US9141</b>	2.5L V6 2508cc	1988-1991	DLX, LE	<b>US9258</b>
2.4L L4 2366cc	1990-1995	SR5	<b>US9141</b>	3.0L V6 2959cc	1992	DLX, LE, SE, XLE	<b>US9258</b>
2.7L L4 2694cc	1996-2000	Base	<b>US9293</b>	3.0L V6 2959cc	1993	DX, LE, SE, XLE	<b>US9258</b>
2.7L L4 2694cc	2010	SR5	<b>US9293</b>	3.0L V6 2959cc	1994-1996	LE, SE, XLE	<b>US9306</b>
3.0L V6 2959cc	1988	SR5	<b>US9142</b>	3.0L V6 2959cc	1997-1998	CE, LE, XLE	<b>US9306</b>
3.0L V6 2959cc	1989	DLX, SR5; Standard Trans	<b>US9142</b>	3.0L V6 2959cc	1999-2001	LE, XLE	<b>US9306</b>
3.0L V6 2959cc	1989	DLX, SR5; Automatic Trans	<b>US9145</b>	3.0L V6 2959cc	2002-2003	LE, SE, XLE	<b>US9306</b>
3.0L V6 2959cc	1990	SR5; Standard Trans	<b>US9142</b>	3.0L V6 2959cc	2004-2006	LE, XLE	<b>US9306</b>
3.0L V6 2959cc	1990	SR5; Automatic Trans	<b>US9145</b>	3.0L V6 2959cc	2004	SE	<b>US9306</b>
3.0L V6 2959cc	1991-1992	SR5	<b>US9145</b>	3.0L V6 2959cc	2005-2006	SE	<b>US9306</b>
3.0L V6 2959cc	1993-1995	SR5	<b>US9291</b>	3.5L V6 3456cc	2007-2011	LE, SE, XLE	<b>US6047</b>
3.0L V6 2959cc	1993-1995	W/O BYPASS TUBE	<b>US9320</b>	3.5L V6 3456cc	2012-2014	SE, XLE	<b>US6047</b>
3.4L V6 3378cc	1996-2000	Limited, SR5	<b>US9324</b>	3.5L V6 3456cc	2015-2017	XLE, XSE	<b>US6047</b>
3.4L V6 3378cc	2001	Base, Limited, SR5	<b>US9324</b>	<b>CELICA</b>			
3.4L V6 3378cc	2002	Limited, SR5	<b>US9324</b>	1.6L L4 1587cc	1990-1993	ST	<b>US9057</b>
4.0L V6 3956cc 241 CID	2003-2009	Limited, Sport, SR5	<b>US6037</b>	1.8L L4 1762cc 107 CID	1994-1997	ST	<b>US9272</b>
4.0L V6 3956cc 241 CID	2010-2014	Limited, SR5, Trail	<b>US6599</b>				
4.0L V6 3956cc 241 CID	2015-2016	Limited, SR5, Trail, TRD Pro	<b>US6599</b>				
4.0L V6 3956cc 241 CID	2017	Limited, SR5, TRD Off-Road, TRD Pro	<b>US6599</b>				
4.7L V8 4663cc 285 CID	2003-2009	Limited, Sport, SR5	<b>US9257</b>				

Engine	Years	Application Description	USMW	Engine	Years	Application Description	USMW
<b>TOYOTA (cont'd.)</b>				<b>TOYOTA (cont'd.)</b>			
<b>CELICA (cont'd.)</b>				<b>CORONA (cont'd.)</b>			
1.8L L4 1762cc 107 CID	1994-1997	ST; Includes back housing	US9272-2	2.4L L4 2366cc	1981-1982	DLX, LE	US9017
1.8L L4 1794cc	2000-2005	GT	US9376	<b>CRESSIDA</b>			
1.8L L4 1795cc	2000-2005	GTS	US9405	2.6L L6 2563cc	1978-1979		US9170
2.0L L4 1995cc	1986	ST	US9048	2.6L L6 2563cc	1978-1979		US9180
2.0L L4 1998cc	1986	GT	US9048	2.8L L6 2754cc	1983-1988	Luxury	US9040N
2.0L L4 1998cc	1986-1989	GTS	US9140	3.0L L6 2954cc	1989-1992	Luxury	US9100
2.0L L4 1998cc 122 CID	1987-1989	GT, ST; Pump only	US9099	<b>CROWN</b>			
2.0L L4 1998cc 122 CID	1987-1989	GT, ST; Includes back housing	US9099-2	2.3L L6 2253cc 138 CID	1967-1971		US9180
2.0L L4 1998cc 122 CID	1988-1992	All Trac	US9140	<b>ECHO</b>			
2.0L L4 1998cc 122 CID	1993	GTS All Trac	US9140	1.5L L4 1497cc	2000-2005	Base	US9406
2.2L L4 2164cc	1990-1993	GT, GTS; Pump only	US9099	<b>FJ CRUISER</b>			
2.2L L4 2164cc	1990-1993	GT, GTS; Includes back housing	US9099-2	4.0L V6 3956cc 241 CID	2007	Base, TRD Special Edition	US6037
2.2L L4 2164cc	1994-1999	GT; Pump only	US9099	4.0L V6 3956cc 241 CID	2008	Base, Trail Teams Special Edition	US6037
2.2L L4 2164cc	1994-1999	GT; Includes back housing	US9099-2	4.0L V6 3956cc 241 CID	2009	Base	US6037
2.2L L4 2189cc	1975-1977		US9027	4.0L V6 3956cc 241 CID	2010-2014	Base	US6599
2.2L L4 2189cc	1978-1979		US9017	4.0L V6 3956cc 241 CID	2013-2014	Mexican Application	US6599
2.2L L4 2189cc	1980	GT, ST	US9017	<b>HIACE</b>			
2.4L L4 2366cc	1981-1982	GT, ST	US9017	2.7L L4 2694cc 164 CID	2006-2009	Mexican Application	US9293
2.4L L4 2366cc	1983-1984	GT, GTS, ST	US9017	2.7L L4 2694cc 164 CID	2011-2012	Mexican Application	US9293
2.4L L4 2366cc	1985	GT, GTS, ST	US9141	<b>HIGHLANDER</b>			
2.6L L6 2563cc	1979	Supra	US9170	2.4L L4 2362cc	2001-2007	Base	US9414
2.6L L6 2563cc	1979	Supra	US9180	2.7L L4 2672cc 163 CID	2009-2011	Base	US6252
2.8L L6 2754cc	1982-1986	Supra	US9040N	2.7L L4 2672cc 163 CID	2012	Base, SE	US6252
<b>COROLLA</b>				2.7L L4 2672cc 163 CID	2013	Base, Plus	US6252
1.2L L4 1166cc	1977		US9021	2.7L L4 2672cc 163 CID	2014-2017	LE	US6252
1.2L L4 1166cc	1978-1979		US9015	3.0L V6 2995cc	2001-2003	Base, Limited	US9306
1.2L L4 1166cc 71 CID	1971-1974		US1006	3.3L V6 3300cc	2004	Base, Limited	US9306
1.6L L4 1587cc	1983	Base, DLX, SR5	US9057	3.3L V6 3300cc 202 CID	2005	Base, Limited	US9306
1.6L L4 1587cc	1984	Base, DLX, LE	US9057	3.3L V6 3300cc 202 CID	2006-2007	Base, Hybrid, Hybrid Limited, Limited, Sport	US9306
1.6L L4 1587cc	1984-1987	Sport DLX, Sport SR5	US9046	3.3L V6 3300cc 202 CID	2008-2010	Hybrid, Hybrid Limited	US9306
1.6L L4 1587cc	1985-1986	DLX, LE, LE Limited	US9057	3.5L V6 3456cc	2008-2009	Base, Limited, Sport	US6047
1.6L L4 1587cc	1985-1987	Sport GTS	US9075	3.5L V6 3456cc	2010	Base, Limited, SE, Sport	US6047
1.6L L4 1587cc	1987	DLX, FX, LE	US9057	3.5L V6 3456cc	2011	Base, Hybrid, Hybrid Limited, Limited	US6047
1.6L L4 1587cc	1987	FX16, FX16 GTS	US9076	3.5L V6 3456cc	2012	Base, Hybrid, Hybrid Limited, Limited, SE	US6047
1.6L L4 1587cc	1988	DLX, DLX All Trac, FX, LE, SR5, SR5 All Trac	US9057	3.5L V6 3456cc	2013	Base, Hybrid, Hybrid Limited, Limited, Plus, SE	US6047
1.6L L4 1587cc	1988	FX16, FX16 GTS, GTS	US9076	3.5L V6 3456cc	2014-2016	Hybrid Limited, LE, LE Plus, Limited, XLE	US6047
1.6L L4 1587cc	1989	DLX, DLX All Trac, LE, SR5, SR5 All Trac	US9057	3.5L V6 3456cc	2017	Hybrid LE, Hybrid Limited, Hybrid XLE, LE, LE Plus, Limited, SE, XLE	US8150
1.6L L4 1587cc	1989-1991	GTS	US9076	<b>HILUX</b>			
1.6L L4 1587cc	1990	Base, DLX, DLX All Trac, LE, SR5, SR5 All Trac	US9057	2.7L L4 2694cc 164 CID	2004-2010	Mexican Application	US9293
1.6L L4 1587cc	1991	Base, DLX, DLX All Trac, LE, SR5	US9057	<b>LAND CRUISER</b>			
1.6L L4 1587cc	1992	Base, DLX, DLX All Trac, LE	US9057	3.9L L6 3878cc	1969-1974		US9078
1.6L L4 1587cc	1993-1996	Base	US9271	4.0L L6 3956cc	1988-1989	Base	US9155
1.6L L4 1587cc	1997	Base, CE	US9271	4.0L L6 3956cc	1990	Base; From 01/1990	US9155
1.6L L4 1588cc	1975		US9012	4.0L L6 3956cc	1990	Base; To 01/1990	US9155
1.6L L4 1588cc	1976	To 12/75	US9012	4.0L L6 3956cc	1991-1992	Base	US9155
1.6L L4 1588cc	1976	From 12/75	US9012	4.2L L6 4227cc	1977-1979	(Exc.Oil Cooler)	US9327
1.6L L4 1588cc	1977-1979		US9018	4.2L L6 4227cc	1977-1979	(Exc.Oil Cooler) (To 01/79)	US9493
1.8L L4 1762cc 107 CID	1993-1995	DX, LE	US9272	4.2L L6 4227cc	1979	(From 01/79)	US9189
1.8L L4 1762cc 107 CID	1993-1995	DX, LE; Includes back housing	US9272-2	4.2L L6 4227cc	1980	Base	US9189
1.8L L4 1762cc 107 CID	1996	DX	US9272	4.2L L6 4227cc	1981-1987	Base	US9337
1.8L L4 1762cc 107 CID	1996	DX; Includes back housing	US9272-2	4.5L L6 4477cc	1993-1997	Base	US9269
1.8L L4 1762cc 107 CID	1997	CE, DX, LE	US9272	4.7L V8 4663cc 285 CID	1998-2007	Base	US9257
1.8L L4 1762cc 107 CID	1997	CE, DX, LE; Includes back housing	US9272-2	5.7L V8 5663cc 345 CID	2008-2011	Base	US6197
1.8L L4 1770cc	1980-1982	Base, DLX, SR5	US9018	5.7L V8 5663cc 345 CID	2013-2017	Base	US6197
1.8L L4 1794cc	1998	CE, LE, VE; Exc.Japan Built Part	US9376	<b>MARK II</b>			
1.8L L4 1794cc	1998	CE, LE, VE; Japan Built Part	US9376	2.6L L6 2563cc	1974-1976		US9180
1.8L L4 1794cc	1999-2000	CE, LE, VE	US9376	<b>MATRIX</b>			
1.8L L4 1794cc	2001-2002	CE, LE, S	US9376	1.8L L4 1794cc	2003-2008	Base, XR	US9376
1.8L L4 1794cc	2003-2008	CE, LE, S; Exc.Japan Built	US9376	1.8L L4 1795cc	2003	XR5	US9405
1.8L L4 1794cc	2003-2008	CE, LE, S; Japan Built	US9376	1.8L L4 1795cc	2004	XR5; From 05/04	US9405
1.8L L4 1795cc	2005-2006	XRS	US9405	1.8L L4 1795cc	2004	XR5; To 05/04	US9405
1.8L L4 1798cc	2009-2010	Base, LE, S, XLE	US6232	1.8L L4 1795cc	2005-2006	XR5	US9405
1.8L L4 1798cc	2011	Base, LE, S; Exc.Japan Built Part	US6232	1.8L L4 1798cc	2009-2010	Base	US6232
1.8L L4 1798cc	2011	Base, LE, S; Japan Built Part	US6232	1.8L L4 1798cc	2011-2013	Base; Exc.Japan Built Part	US6232
1.8L L4 1798cc	2012-2015	L, LE, S; Exc.Japan Built Part	US6232	1.8L L4 1798cc	2011-2013	Base; Japan Built Part	US6232
1.8L L4 1798cc	2012-2015	L, LE, S; Japan Built Part	US6232	2.4L L4 2362cc	2009-2010	S, XR5; Exc.Japan Built Part	US9414
1.8L L4 1798cc	2014-2015	L, LE, S	US6232	2.4L L4 2362cc	2009-2010	S, XR5; Japan Built Part	US9414
1.8L L4 1798cc	2016	L, LE, S, Special Edition	US6232	2.4L L4 2362cc	2011	S	US9414
1.8L L4 1798cc	2017	50th Anniversary Special Edition, L, LE, SE, XLE, XSE	US6232	2.4L L4 2362cc	2012	S; From 04/2012	US9414
1.8L L4 1839cc	1984-1985	DLX	US9059	2.4L L4 2362cc	2012	S; To 04/2012	US9414
2.4L L4 2362cc	2009-2010	XR5; Engine # 0XXXXXX-6XXXXXX, Engine # 0XXXXXX-BXXXXXX, Engine # 0XXXXXX-HXXXXXX	US9414	2.4L L4 2362cc	2013	S	US9414
2.4L L4 2362cc	2009-2010	XR5; Engine # 7XXXXXX-9XXXXXX, Engine # 7XXXXXX-A9XXXXX, Engine # 7XXXXXX-AXXXXXX	US9414	<b>MR2</b>			
<b>CORONA</b>				1.6L L4 1587cc	1985-1987	GT	US9076
1.9L L4 1897cc 116 CID	1968-1970		US9181	1.6L L4 1587cc	1988-1989	GT, Super Charged	US9076
2.2L L4 2189cc	1975		US9005	2.0L L4 1998cc 122 CID	1991-1995	Turbo	US9140
2.2L L4 2189cc	1976	From 09/75	US9027	2.2L L4 2164cc	1991-1995	Base; Pump only	US9099
2.2L L4 2189cc	1977		US9027				
2.2L L4 2189cc	1978-1979		US9017				
2.2L L4 2189cc	1980	DLX, LE	US9017				

**WATER PUMPS**



Engine	Years	Application Description	USMW
<b>TOYOTA (cont'd.)</b>			
<b>MR2 (cont'd.)</b>			
2.2L L4 2164cc	1991-1995	Base; Includes back housing	<b>US9099-2</b>
<b>MR2 SPYDER</b>			
1.8L L4 1794cc	2000-2005	Base	<b>US9376</b>
1.8L L4 1794cc	2006		<b>US9376</b>
<b>PASEO</b>			
1.5L L4 1497cc	1992-1994	Base	<b>US9098</b>
1.5L L4 1497cc	1995-1996	Base	<b>US9334</b>
1.5L L4 1497cc	1997	Base, Convertible; From 11/1996	<b>US9334</b>
1.5L L4 1497cc	1997	Base, Convertible; To 11/1996	<b>US9334</b>
1.5L L4 1497cc	1998	Base, Convertible	<b>US9334</b>
<b>PICKUP</b>			
2.2L L4 2188cc	1981-1982	DLX	<b>US9094</b>
2.2L L4 2188cc	1983	DLX, SR5	<b>US9094</b>
2.2L L4 2189cc	1975		<b>US9005</b>
2.2L L4 2189cc	1976-1977		<b>US9027</b>
2.2L L4 2189cc	1978-1979		<b>US9017</b>
2.2L L4 2189cc	1980	Base, DLX, SR5	<b>US9017</b>
2.4L L4 2366cc	1981-1984	Base, DLX, SR5	<b>US9017</b>
2.4L L4 2366cc	1985	Base, DLX, SR5, SR5 Turbo	<b>US9141</b>
2.4L L4 2366cc	1986-1987	Base, Base Turbo, DLX, SR5, SR5 Turbo	<b>US9141</b>
2.4L L4 2366cc	1988	Base, DLX, SR5, SR5 Turbo	<b>US9141</b>
2.4L L4 2366cc	1989-1990	Base, DLX, SR5	<b>US9141</b>
2.4L L4 2366cc	1991-1995	Base, DLX	<b>US9141</b>
2.4L L4 2446cc	1984	DLX	<b>US9200</b>
2.4L L4 2446cc	1985	DLX, DLX Turbo	<b>US9200</b>
3.0L V6 2959cc	1988	Base, DLX, SR5	<b>US9142</b>
3.0L V6 2959cc	1989	DLX, SR5; 4WD, Standard Trans	<b>US9142</b>
3.0L V6 2959cc	1989	DLX, SR5; RWD, Standard Trans; 1/2 Ton Chassis	<b>US9142</b>
3.0L V6 2959cc	1989	DLX, SR5; 4WD, Automatic Trans	<b>US9145</b>
3.0L V6 2959cc	1989	DLX, SR5; Automatic Trans, RWD; 1/2 Ton Chassis	<b>US9145</b>
3.0L V6 2959cc	1989	DLX, SR5; RWD; 1 Ton Chassis	<b>US9145</b>
3.0L V6 2959cc	1990	DLX, SR5; 4WD, Standard Trans; To 02/1990	<b>US9142</b>
3.0L V6 2959cc	1990	DLX, SR5; RWD, Standard Trans; 1/2 Ton Chassis, To 02/1990	<b>US9142</b>
3.0L V6 2959cc	1990	DLX, SR5; 4WD, Automatic Trans; To 02/1990	<b>US9145</b>
3.0L V6 2959cc	1990	DLX, SR5; 4WD; From 02/1990	<b>US9145</b>
3.0L V6 2959cc	1990	DLX, SR5; Automatic Trans, RWD; 1/2 Ton Chassis, To 02/1990	<b>US9145</b>
3.0L V6 2959cc	1990	DLX, SR5; RWD; 1 Ton Chassis, To 02/1990	<b>US9145</b>
3.0L V6 2959cc	1990	DLX, SR5; RWD; From 02/1990	<b>US9145</b>
3.0L V6 2959cc	1991-1992	DLX, SR5	<b>US9145</b>
3.0L V6 2959cc	1993-1995	DLX, SR5	<b>US9291</b>
3.0L V6 2959cc	1993-1995	W/O BYPASS TUBE	<b>US9320</b>
<b>PREVIA</b>			
2.4L L4 2438cc	1991-1997	DX, LE	<b>US9216</b>
<b>PRIUS</b>			
1.5L L4 1497cc	2001-2006	Base	<b>US9406</b>
1.5L L4 1497cc	2004-2006	Base; ELECTRIC/GAS; HVAC System	<b>US11011</b>
1.5L L4 1497cc	2004-2006	Base; ELECTRIC/GAS; Heat Storage Tank Assy.	<b>US11013</b>
1.5L L4 1497cc	2007-2009	Base, Touring	<b>US9406</b>
1.5L L4 1497cc	2007-2009	Base, Touring; ELECTRIC/GAS; HVAC System	<b>US11011</b>
1.5L L4 1497cc	2007-2009	Base, Touring; ELECTRIC/GAS; Heat Storage Tank Assy.	<b>US11013</b>
1.8L L4 1798cc 110 CID	2010-2011	Base	<b>US6682</b>
1.8L L4 1798cc 110 CID	2012-2014	Five, Four, Three, Two	<b>US6682</b>
1.8L L4 1798cc 110 CID	2013-2014	Mexican Application	<b>US6682</b>
1.8L L4 1798cc 110 CID	2015	Five, Four, One, Persona Series, Three, Two	<b>US6682</b>
<b>PRIUS C</b>			
1.5L L4 1497cc 91 CID	2012-2015	Four, One, Three, Two	<b>US6682</b>
1.5L L4 1497cc 91 CID	2016	Four, One, Persona Series, Three, Two	<b>US6682</b>
1.5L L4 1497cc 91 CID	2017	Four, One, Three, Two	<b>US6682</b>
<b>PRIUS PLUG-IN</b>			
1.8L L4 1798cc 110 CID	2012	Base	<b>US6682</b>
1.8L L4 1798cc 110 CID	2013		<b>US6682</b>
1.8L L4 1798cc 110 CID	2014-2015	Base	<b>US6682</b>
<b>PRIUS V</b>			
1.8L L4 1798cc 110 CID	2012-2014	Five, Three, Two	<b>US6682</b>
1.8L L4 1798cc 110 CID	2015-2017	Five, Four, Three, Two	<b>US6682</b>
<b>RAV4</b>			
2.0L L4 1998cc 122 CID	1996-2000	Base; Pump only	<b>US9099</b>
2.0L L4 1998cc 122 CID	1996-2000	Base; Includes back housing	<b>US9099-2</b>
2.0L L4 1998cc 122 CID	2001-2003	Base	<b>US9414</b>
2.4L L4 2362cc	2004	Base	<b>US9414</b>
2.4L L4 2362cc	2005	Base, L, Sport	<b>US9414</b>

Engine	Years	Application Description	USMW
<b>TOYOTA (cont'd.)</b>			
<b>RAV4 (cont'd.)</b>			
2.4L L4 2362cc	2006-2008	Base, Limited, Sport	<b>US9414</b>
2.5L L4 2494cc 152 CID	2009-2012	Base, Limited, Sport	<b>US6252</b>
2.5L L4 2494cc 152 CID	2013-2015	LE, Limited, XLE	<b>US6252</b>
2.5L L4 2494cc 152 CID	2016	LE, Limited, SE, XLE	<b>US6252</b>
2.5L L4 2494cc 152 CID	2017	LE, Limited, Platinum, SE, XLE	<b>US6252</b>
3.5L V6 3456cc	2006-2012	Base, Limited, Sport	<b>US6047</b>
<b>SEQUOIA</b>			
4.6L V8 4608cc	2010-2011	Limited, SR5; Exc.Japan Built Part	<b>US6336</b>
4.6L V8 4608cc	2010-2011	Limited, SR5; Japan Built Part	<b>US6336</b>
4.6L V8 4608cc	2012	SR5; Exc.Japan Built Part	<b>US6336</b>
4.6L V8 4608cc	2012	SR5; Japan Built Part	<b>US6336</b>
4.7L V8 4663cc 285 CID	2001-2008	Limited, SR5	<b>US9257</b>
4.7L V8 4663cc 285 CID	2009	Limited, SR5; From 11/2008	<b>US9257</b>
4.7L V8 4663cc 285 CID	2009	Limited, SR5; To 11/2008	<b>US9257</b>
5.7L V8 5663cc 345 CID	2008-2009	Limited, Platinum, SR5	<b>US6197</b>
5.7L V8 5663cc 345 CID	2010	Limited, Platinum, SR5; Exc.Japan Built Part	<b>US6197</b>
5.7L V8 5663cc 345 CID	2010	Limited, Platinum, SR5; Japan Built Part	<b>US6197</b>
5.7L V8 5663cc 345 CID	2011-2017	Limited, Platinum, SR5	<b>US6197</b>
<b>SIENNA</b>			
2.7L L4 2672cc 163 CID	2011-2012	Base, LE	<b>US6252</b>
3.0L V6 2995cc	1998	CE, LE	<b>US9306</b>
3.0L V6 2995cc	1999	CE, LE, XLE	<b>US9306</b>
3.0L V6 2995cc	2000	CE, LE	<b>US9306</b>
3.0L V6 2995cc	2001-2003	CE, LE, XLE	<b>US9306</b>
3.3L V6 3300cc 202 CID	2004-2005	CE, LE, XLE, XLE Limited	<b>US9306</b>
3.3L V6 3300cc 202 CID	2006	CE, LE, Limited, XLE	<b>US9306</b>
3.5L V6 3456cc	2007-2008	CE, LE, Limited, XLE	<b>US6047</b>
3.5L V6 3456cc	2009	CE, LE, XLE; From 01/2009	<b>US6047</b>
3.5L V6 3456cc	2009	CE, LE, XLE; To 01/2009	<b>US6047</b>
3.5L V6 3456cc	2010	CE, LE, XLE	<b>US6047</b>
3.5L V6 3456cc	2011-2012	Base, LE, Limited, SE, XLE	<b>US6047</b>
3.5L V6 3456cc	2013	Base, L, LE, Limited, SE, XLE	<b>US6047</b>
3.5L V6 3456cc	2014-2016	L, LE, Limited, SE, XLE	<b>US6047</b>
3.5L V6 3456cc	2017	L, LE, Limited, SE, XLE	<b>US8150</b>
<b>SOLARA</b>			
2.2L L4 2164cc	1999-2001	SE; Pump only	<b>US9099</b>
2.2L L4 2164cc	1999-2001	SE; Includes back housing	<b>US9099-2</b>
2.4L L4 2362cc	2002-2003	SE; Exc.Japan Built Part	<b>US9414</b>
2.4L L4 2362cc	2002-2003	SE; Japan Built Part	<b>US9414</b>
2.4L L4 2362cc	2004-2005	SE, SLE; Exc.Japan Built Part	<b>US9414</b>
2.4L L4 2362cc	2004-2005	SE, SLE; Japan Built Part	<b>US9414</b>
2.4L L4 2362cc	2006	SE, SE Sport, SLE; Exc.Japan Built Part	<b>US9414</b>
2.4L L4 2362cc	2006	SE, SE Sport, SLE; Japan Built Part	<b>US9414</b>
2.4L L4 2362cc	2007-2008	SE, SLE, Sport; Exc.Japan Built Part	<b>US9414</b>
2.4L L4 2362cc	2007-2008	SE, SLE, Sport; Japan Built Part	<b>US9414</b>
3.0L V6 2995cc	1999-2003	SE, SLE	<b>US9306</b>
3.0L V6 3300cc	2004	SE, SLE	<b>US9306</b>
3.0L V6 3300cc 202 CID	2005	SE, SLE	<b>US9306</b>
3.0L V6 3300cc 202 CID	2006	SE, SE Sport, SLE	<b>US9306</b>
3.0L V6 3300cc 202 CID	2007-2008	SE, SLE, Sport	<b>US9306</b>
<b>STARLET</b>			
1.3L L4 1290cc	1981-1982	Base	<b>US9015</b>
1.3L L4 1290cc	1983-1984	Base	<b>US9064</b>
<b>SUPRA</b>			
3.0L L6 2954cc	1986	Base	<b>US9100</b>
3.0L L6 2954cc	1987-1990	Base, Turbo	<b>US9100</b>
3.0L L6 2954cc	1991	Base; Naturally Aspirated	<b>US9100</b>
3.0L L6 2954cc	1991	Turbo	<b>US9100</b>
3.0L L6 2954cc	1992	Base, Turbo	<b>US9100</b>
3.0L L6 2997cc	1993-1998	Base	<b>US9256</b>
3.0L L6 2997cc	1993-1998	Twin Turbo	<b>US9292</b>
<b>T100</b>			
2.7L L4 2694cc	1994-1998	Base	<b>US9293</b>
3.0L V6 2959cc	1993	Base, One-Ton, SR5	<b>US9291</b>
3.0L V6 2959cc	1993-1994	W/O BYPASS TUBE	<b>US9320</b>
3.0L V6 2959cc	1994	DX, SR5	<b>US9291</b>
3.4L V6 3378cc	1995	Base, One-Ton DLX; Standard Trans	<b>US9324</b>
3.4L V6 3378cc	1995	DX, SR5; 4WD	<b>US9324</b>
3.4L V6 3378cc	1995	DX, SR5; RWD, Standard Trans	<b>US9324</b>
3.4L V6 3378cc	1995	Base, One-Ton DLX; Automatic Trans	<b>US9325</b>
3.4L V6 3378cc	1995	DX, SR5; Automatic Trans, RWD	<b>US9325</b>
3.4L V6 3378cc	1996-1997	DLX, SR5; 4WD	<b>US9324</b>
3.4L V6 3378cc	1996-1997	DLX, SR5; RWD, Standard Trans	<b>US9324</b>
3.4L V6 3378cc	1996-1997	DLX, SR5; Automatic Trans, RWD	<b>US9325</b>
3.4L V6 3378cc	1998	Base, SR5; 4WD	<b>US9324</b>
3.4L V6 3378cc	1998	Base, SR5; RWD, Standard Trans	<b>US9324</b>
3.4L V6 3378cc	1998	Base, SR5; Automatic Trans, RWD	<b>US9325</b>
<b>TACOMA</b>			
2.4L L4 2438cc	1995-1997	Base	<b>US9293</b>
2.4L L4 2438cc	1998-2000	Base, SR5	<b>US9293</b>

Engine	Years	Application Description	USMW
<b>TOYOTA (cont'd.)</b>			
<b>TACOMA (cont'd.)</b>			
2.4L L4 2438cc	2001-2004	Base	US9293
2.7L L4 2694cc	1995-1997	Base	US9293
2.7L L4 2694cc	1998-2000	Base, Pre Runner, SR5	US9293
2.7L L4 2694cc	2001-2015	Base, Pre Runner	US9293
2.7L L4 2694cc	2016-2017	SR, SR5	US9293
3.4L V6 3378cc	1995-1997	Base; 4WD	US9324
3.4L V6 3378cc	1995-1997	Base; Automatic Trans, RWD; Floor Shift	US9324
3.4L V6 3378cc	1995-1997	Base; RWD, Standard Trans	US9324
3.4L V6 3378cc	1995-1997	SR5	US9324
3.4L V6 3378cc	1995-1997	Base; Automatic Trans, RWD; Column Shift	US9325
3.4L V6 3378cc	1998-2000	Base, SR5; 4WD	US9324
3.4L V6 3378cc	1998-2000	Base, SR5; Automatic Trans, RWD; Floor Shift	US9324
3.4L V6 3378cc	1998-2000	Base, SR5; RWD, Standard Trans	US9324
3.4L V6 3378cc	1998-2000	Limited	US9324
3.4L V6 3378cc	1998-2000	Pre Runner; Floor Shift	US9324
3.4L V6 3378cc	1998-2000	Base, SR5; Automatic Trans, RWD; Column Shift	US9325
3.4L V6 3378cc	1998-2000	Pre Runner; Column Shift	US9325
3.4L V6 3378cc	2001-2004	Base, Pre Runner, S-Runner	US9324
4.0L V6 3956cc 241 CID	2005-2013	Base, Pre Runner, X-Runner	US6037
4.0L V6 3956cc 241 CID	2014	Base, Pre Runner	US6037
4.0L V6 3956cc 241 CID	2015	Base, Pre Runner, TRD Pro	US6037
<b>TERCEL</b>			
1.5L L4 1452cc	1980	DLX, SR5, STD	US9028
1.5L L4 1452cc	1981-1982	DLX, SR5, STD; Exc. Calif	US9045
1.5L L4 1452cc	1981-1982	DLX, SR5, STD; Calif	US9086
1.5L L4 1452cc	1983-1986	DLX, SR5, STD	US9045
1.5L L4 1452cc	1987-1988	DLX, DX, SR5	US9045
1.5L L4 1456cc	1987	DLX, STD	US9098
1.5L L4 1456cc	1988	DLX, EZ, STD	US9098
1.5L L4 1456cc	1989-1990	Base, DX, EZ, STD	US9098
1.5L L4 1456cc	1991-1993	DLX, LE, STD	US9098
1.5L L4 1456cc	1994	DLX, LE, STD; To 08/1994	US9098
1.5L L4 1456cc	1994	DLX, LE, STD; From 08/1994	US9334
1.5L L4 1497cc	1995-1996	DX, STD	US9334
1.5L L4 1497cc	1997	CE; From 11/1996	US9334
1.5L L4 1497cc	1997	CE; To 11/1996	US9334
1.5L L4 1497cc	1998	CE	US9334
<b>TUNDRA</b>			
3.4L V6 3378cc	2000-2004	Base, SR5; Floor Shift	US9324
3.4L V6 3378cc	2000-2004	SR5	US9324
3.4L V6 3378cc	2000-2004	Base, SR5; Column Shift	US9325
4.0L V6 3956cc 241 CID	2005-2010	Base, SR5	US6037
4.0L V6 3956cc 241 CID	2011	Base, SR5; To 10/2010	US6037
4.0L V6 3956cc 241 CID	2011	Base, SR5; From 10/2010	US6599
4.0L V6 3956cc 241 CID	2012-2013	Base	US6599
4.0L V6 3956cc 241 CID	2014	SR	US6599
4.6L V8 4608cc	2010	Base, Limited, SR5; Exc. Japan Built Part	US6336
4.6L V8 4608cc	2010	Base, Limited, SR5; Japan Built Part	US6336
4.6L V8 4608cc	2011	Base, SR5; Exc. Japan Built Part	US6336
4.6L V8 4608cc	2011	Base, SR5; Japan Built Part	US6336
4.6L V8 4608cc	2012-2013	Base; Exc. Japan Built Part	US6336
4.6L V8 4608cc	2012-2013	Base; Japan Built Part	US6336
4.6L V8 4608cc	2014-2017	SR, SR5	US6336
4.7L V8 4663cc 285 CID	2000-2002	Limited, SR5	US9257
4.7L V8 4663cc 285 CID	2003-2004	Limited, SR5; Exc. Japan Built Part	US9257
4.7L V8 4663cc 285 CID	2003-2004	Limited, SR5; Japan Built Part	US9257
4.7L V8 4663cc 285 CID	2005-2008	Base, Limited, SR5	US9257
4.7L V8 4663cc 285 CID	2009	Base, Limited, SR5; From 11/2008	US9257
4.7L V8 4663cc 285 CID	2009	Base, Limited, SR5; To 11/2008	US9257
5.7L V8 5663cc 345 CID	2007-2011	Base, Limited, SR5	US6197
5.7L V8 5663cc 345 CID	2012	Base, Limited	US6197
5.7L V8 5663cc 345 CID	2013	Base, Limited, Platinum	US6197
5.7L V8 5663cc 345 CID	2014	1794 Edition, Limited, Platinum, SR, SR5	US6197
5.7L V8 5663cc 345 CID	2015-2017	1794 Edition, Limited, Platinum, SR, SR5, TRD Pro	US6197
<b>VAN</b>			
2.0L L4 1998cc 122 CID	1984-1985	Wagon Crg, Wagon DX, Wagon LE	US9092
2.2L L4 2237cc	1986-1989	Wagon Crg, Wagon DX, Wagon LE	US9092
<b>VENZA</b>			
2.7L L4 2672cc 163 CID	2009-2011	Base	US6252
2.7L L4 2672cc 163 CID	2012-2015	LE, XLE	US6252
3.5L V6 3456cc	2009-2011	Base	US6047
3.5L V6 3456cc	2012-2014	LE, Limited, XLE	US6047
3.5L V6 3456cc	2015	Limited, XLE	US6047
<b>YARIS</b>			
1.3L L4 1295cc 79 CID	2004-2005	Mexican Application	US9406
1.5L L4 1497cc	2007-2009	Base, S	US9406
1.5L L4 1497cc	2010-2011	Base	US9406
1.5L L4 1497cc	2012	L, LE, SE; From 11/2011	US9406

Engine	Years	Application Description	USMW
<b>TOYOTA (cont'd.)</b>			
<b>YARIS (cont'd.)</b>			
1.5L L4 1497cc	2012	L, LE, SE; To 11/2011	US9406
1.5L L4 1497cc	2013-2017	L, LE, SE	US9406
1.5L L4 1497cc 91 CID	2006	Mexican Application	US9406
1.5L L4 1497cc 91 CID	2011	Mexican Application	US9406
1.5L L4 1497cc 91 CID	2015-2016	SE	US9406
<b>YARIS IA</b>			
1.5L L4 1496cc 91 CID	2017	Base	US6700
<b>VOLKSWAGEN</b>			
<b>ATLANTIC</b>			
1.7L L4 1700cc 104 CID	1981	Mexican Application	US9066
1.7L L4 1700cc 104 CID	1982-1986	Mexican Application	US9065
1.8L L4 1800cc 110 CID	1984-1987	Mexican Application	US9065
<b>BETLE</b>			
1.8L L4 1781cc	1999-2000	GL, GLS, GLX	US9377
1.8L L4 1781cc	1999-2000	GL, GLS, GLX; Electric Water Pump	US11034
1.8L L4 1781cc	2001	GL, GLS, GLX, Sport	US9377
1.8L L4 1781cc	2001	GL, GLS, GLX, Sport; Electric Water Pump	US11034
1.8L L4 1781cc	2002	GL, GLS, GLX, Sport, Turbo S	US9377
1.8L L4 1781cc	2002	GL, GLS, GLX, Sport, Turbo S; Electric Water Pump	US11034
1.8L L4 1781cc	2003	GL, GLS, GLX, Turbo S	US9377
1.8L L4 1781cc	2003	GL, GLS, GLX, Turbo S; Electric Water Pump	US11034
1.8L L4 1781cc	2004	GLS, GLX, Turbo S	US9377
1.8L L4 1781cc	2004	GLS, GLX, Turbo S; Electric Water Pump	US11034
1.8L L4 1781cc	2005	GLS	US9377
1.8L L4 1781cc	2005	GLS; Electric Water Pump	US11034
1.8L L4 1798cc 110 CID	2015	Base, Classic, Fleet Edition; From 07/01/2014	US8124
1.8L L4 1798cc 110 CID	2016	Denim, Dune, Fleet Edition, S, SE, SEL, Wolfsburg Edition	US8124
1.8L L4 1798cc 110 CID	2017	#PinkBeetle, Classic, Dune, S, SE, SEL	US8124
1.9L L4 1896cc 116 CID	1998	TDI	US9378
1.9L L4 1896cc 116 CID	1999-2000	GL, GLS	US9378
1.9L L4 1896cc 116 CID	2001-2002	GL, GLS, Sport	US9378
1.9L L4 1896cc 116 CID	2003	GL, GLS	US9378
1.9L L4 1896cc 116 CID	2004	GL, GLS; (BEW)	US6034
1.9L L4 1896cc 116 CID	2005	GLS TDI	US6034
1.9L L4 1896cc 116 CID	2006	TDI	US6034
2.0L L4 1968cc 120 CID	2013	TDI; From 04/28/2012	US6034
2.0L L4 1968cc 120 CID	2013	TDI; To 04/28/2012	US6034
2.0L L4 1968cc 120 CID	2014	TDI	US6034
2.0L L4 1984cc 121 CID	1998	Base	US9377
2.0L L4 1984cc 121 CID	1999-2000	GL, GLS	US9377
2.0L L4 1984cc 121 CID	2001-2002	GL, GLS, Sport	US9377
2.0L L4 1984cc 121 CID	2003	GL, GLS	US9377
2.0L L4 1984cc 121 CID	2004	GL, GLS; (BGD)	US9377
2.0L L4 1984cc 121 CID	2004-2005	GL, GLS; (BEV)	US9377
2.0L L4 1984cc 121 CID	2006-2011	Mexican Application	US9377
2.0L L4 1984cc 121 CID	2012	Turbo; (CCTA); From 05/31/2012, Pump only	US9047
2.0L L4 1984cc 121 CID	2012	Turbo; (CCTA); Pump only, To 05/31/2012	US9047
2.0L L4 1984cc 121 CID	2012	Turbo; (CCTA); From 05/31/2012, With back plate housing	US9047-2
2.0L L4 1984cc 121 CID	2012	Turbo; (CCTA); To 05/31/2012, With back plate housing	US9047-2
2.0L L4 1984cc 121 CID	2012-2013	Turbo; Electric Water Pump	US11008
2.0L L4 1984cc 121 CID	2013	Turbo; (CCTA); Pump only	US9047
2.0L L4 1984cc 121 CID	2013	Turbo; (CCTA); With back plate housing	US9047-2
2.0L L4 1984cc 121 CID	2015	R-Line	US8124
2.0L L4 1984cc 121 CID	2016	R-Line S, R-Line SE, R-Line SEL	US8124
2.0L L4 1984cc 121 CID	2017	R-Line SEL	US8124
2.5L L5 2480cc 151 CID	2006-2007	2.5; (BPR)	US6050
2.5L L5 2480cc 151 CID	2006-2007	2.5; (BPS)	US6050
2.5L L5 2480cc 151 CID	2008	S, SE; (BPR)	US6050
2.5L L5 2480cc 151 CID	2008	S, SE; (BPS)	US6050
2.5L L5 2480cc 151 CID	2009-2010	Base; (BPR)	US6050
2.5L L5 2480cc 151 CID	2009-2010	Base; (BPS)	US6050
2.5L L5 2480cc 151 CID	2010	Mexican Application	US6050
2.5L L5 2480cc 151 CID	2012-2014	Base; (CBTA)	US6050
2.5L L5 2480cc 151 CID	2012-2014	Base; (CBUA)	US6050
2.5L L5 2480cc 151 CID	2012-2014	Mexican Application	US6050
2.5L L5 2480cc 151 CID	2014	Base	US6050
<b>BORA</b>			
1.9L L4 1896cc 116 CID	2007-2010	Mexican Application	US6212
2.0L H4 1984cc 121 CID	2007-2010	Mexican Application	US6022
2.0L L4 1984cc 121 CID	2006	Mexican Application	US9377
2.5L L5 2480cc 151 CID	2005-2009	Mexican Application	US6050
2.5L L5 2480cc 151 CID	2010	Mexican Application	US9262

WATER PUMPS

Engine	Years	Application Description	USMW	Engine	Years	Application Description	USMW
<b>VOLKSWAGEN (cont'd.)</b>				<b>VOLKSWAGEN (cont'd.)</b>			
<b>CABRIO</b>				<b>COMBI</b>			
2.0L L4 1984cc 121 CID	1995-1996	Base	US9065	1.8L L4 1780cc 108 CID	1998-2001	Mexican Application	US9065
2.0L L4 1984cc 121 CID	1995-1996	Base; Includes back housing	US9065-2	1.8L L4 1800cc 110 CID	1989-1997	Mexican Application	US9065
2.0L L4 1984cc 121 CID	1997	Base, High Line	US9065	<b>CORRADO</b>			
2.0L L4 1984cc 121 CID	1997	Base, High Line; Includes back housing	US9065-2	1.8L L4 1780cc	1990-1992	G60	US9065
2.0L L4 1984cc 121 CID	1998	Base, GL, GLS	US9065	1.8L L4 1780cc	1990-1992	G60; Includes back housing	US9065-2
2.0L L4 1984cc 121 CID	1998	Base, GL, GLS; Includes back housing	US9065-2	2.8L V6 2792cc	1992-1994	SLC	US9262
2.0L L4 1984cc 121 CID	1999	Base, GLS	US9065	2.8L V6 2792cc	1992-1994	SLC; Electric Water Pump	US11034
2.0L L4 1984cc 121 CID	1999	Base, GLS; Includes back housing	US9065-2	<b>CRAFTER</b>			
2.0L L4 1984cc 121 CID	2000	GL, GLS	US9065	2.5L L5 2459cc 150 CID	2008-2011		US9274-20
2.0L L4 1984cc 121 CID	2000	GL, GLS; Includes back housing	US9065-2	2.5L L5 2459cc 151 CID	2008-2011	Mexican Application	US6050
2.0L L4 1984cc 121 CID	2001-2002	GL, GLS, GLX	US9065	<b>CROSSFOX</b>			
2.0L L4 1984cc 121 CID	2001-2002	GL, GLS, GLX; Includes back housing	US9065-2	1.6L L4 1599cc 98 CID	2007-2009		US8949
<b>CABRIOLET</b>				1.6L L4 1600cc 98 CID	2007-2009	Mexican Application	US8949
1.8L L4 1780cc	1985-1986	Base	US9065	<b>DASHER</b>			
1.8L L4 1780cc	1985-1986	Base; Includes back housing	US9065-2	1.5L L4 1471cc	1975		US9066
1.8L L4 1780cc	1987	Base, Wolfsburg Edition	US9065	1.5L L4 1471cc	1979		US9066
1.8L L4 1780cc	1987	Base, Wolfsburg Edition; Includes back housing	US9065-2	1.5L L4 1471cc	1980	Base	US9066
1.8L L4 1780cc	1988	Base, Bestseller, Boutique	US9065	1.6L L4 1588cc 97 CID	1976-1979		US9066
1.8L L4 1780cc	1988	Base, Bestseller, Boutique; Includes back housing	US9065-2	1.6L L4 1588cc 97 CID	1980-1981	Base	US9066
1.8L L4 1780cc	1989	Base, Bestseller, Boutique, Wolfsburg Edition	US9065	<b>DERBY</b>			
1.8L L4 1780cc	1989	Base, Bestseller, Boutique, Wolfsburg Edition; Includes back housing	US9065-2	1.8L L4 1780cc 108 CID	1998-2001	Mexican Application	US9065
1.8L L4 1780cc	1990	Base, Bestseller, Boutique	US9065	1.8L L4 1781cc 109 CID	2002-2009	Mexican Application	US9065
1.8L L4 1780cc	1990	Base, Bestseller, Boutique; Includes back housing	US9065-2	1.8L L4 1800cc 110 CID	1995-1997	Mexican Application	US9065
1.8L L4 1780cc	1991	Base, Carat, Etienne Aigner	US9065	2.0L L4 1984cc 121 CID	2002-2003	Mexican Application	US9377
1.8L L4 1780cc	1991	Base, Carat, Etienne Aigner; Includes back housing	US9065-2	<b>EOS</b>			
1.8L L4 1780cc	1992	Base, Carat, Classic, Wolfsburg Edition	US9065	2.0L L4 1984cc 121 CID	2007	2.0T, Base	US6022
1.8L L4 1780cc	1992	Base, Carat, Classic, Wolfsburg Edition; Includes back housing	US9065-2	2.0L L4 1984cc 121 CID	2007	2.0T, Base	US11017
1.8L L4 1780cc	1993	Base, Classic	US9065	2.0L L4 1984cc 121 CID	2008	Komfort, Lux, Turbo	US6022
1.8L L4 1780cc	1993	Base, Classic; Includes back housing	US9065-2	2.0L L4 1984cc 121 CID	2008	Komfort, Lux, Turbo	US11017
<b>CARIBE</b>				2.0L L4 1984cc 121 CID	2009	Komfort, Lux; (BPY)	US6022
1.6L L4 1588cc 97 CID	1977-1978		US9066	2.0L L4 1984cc 121 CID	2009	Komfort, Lux; (CBFA); Pump only	US9047
1.6L L4 1588cc 97 CID	1979	Diesel	US9066	2.0L L4 1984cc 121 CID	2009	Komfort, Lux; (CCTA); Pump only	US9047
1.6L L4 1600cc 98 CID	1977-1980	Mexican Application	US9066	2.0L L4 1984cc 121 CID	2009	Komfort, Lux; (CBFA); With back plate housing	US9047-2
1.7L L4 1700cc 104 CID	1981-1986	Mexican Application	US9065	2.0L L4 1984cc 121 CID	2009	Komfort, Lux; (CCTA); With back plate housing	US9047-2
1.8L L4 1800cc 110 CID	1984	Mexican Application	US9066	2.0L L4 1984cc 121 CID	2009	Komfort, Lux	US11017
1.8L L4 1800cc 110 CID	1985-1987	Mexican Application	US9065	2.0L L4 1984cc 121 CID	2009-2011	Komfort, Lux; Electric Water Pump	US11008
<b>CC</b>				2.0L L4 1984cc 121 CID	2010-2011	Komfort, Lux; Pump only	US9047
2.0L L4 1984cc 121 CID	2009-2010	Luxury, Sport; Pump only	US9047	2.0L L4 1984cc 121 CID	2010-2011	Komfort, Lux; With back plate housing	US9047-2
2.0L L4 1984cc 121 CID	2009-2010	Luxury, Sport; With back plate housing	US9047-2	2.0L L4 1984cc 121 CID	2012	Executive, Komfort, Lux; Pump only	US9047
2.0L L4 1984cc 121 CID	2009-2010	Luxury, Sport; Electric Water Pump	US11008	2.0L L4 1984cc 121 CID	2012	Executive, Komfort, Lux; With back plate housing	US9047-2
2.0L L4 1984cc 121 CID	2011	Luxury, R-Line, Sport; Pump only	US9047	2.0L L4 1984cc 121 CID	2012	Executive, Komfort, Lux; Electric Water Pump	US11008
2.0L L4 1984cc 121 CID	2011	Luxury, R-Line, Sport; With back plate housing	US9047-2	2.0L L4 1984cc 121 CID	2012	Executive, Komfort, Lux, Sport; Pump only	US9047
2.0L L4 1984cc 121 CID	2011	Luxury, R-Line, Sport; Electric Water Pump	US11008	2.0L L4 1984cc 121 CID	2013	Executive, Komfort, Lux, Sport; With back plate housing	US9047-2
2.0L L4 1984cc 121 CID	2012	Lux, Lux Limited, Lux Plus, R-Line, Sport; Pump only	US9047	2.0L L4 1984cc 121 CID	2013	Executive, Komfort, Lux, Sport; Electric Water Pump	US11008
2.0L L4 1984cc 121 CID	2012	Lux, Lux Limited, Lux Plus, R-Line, Sport; With back plate housing	US9047-2	2.0L L4 1984cc 121 CID	2013	Executive, Komfort, Sport; Pump only	US9047
2.0L L4 1984cc 121 CID	2012	Lux, Lux Limited, Lux Plus, R-Line, Sport; Electric Water Pump	US11008	2.0L L4 1984cc 121 CID	2014	Executive, Komfort, Sport; Includes back housing	US9047-2
2.0L L4 1984cc 121 CID	2013	Lux, R-Line, Sport, Sport Plus; Pump only	US9047	2.0L L4 1984cc 121 CID	2014	Executive, Komfort, Sport; With back plate housing	US9047-2
2.0L L4 1984cc 121 CID	2013	Lux, R-Line, Sport, Sport Plus; With back plate housing	US9047-2	2.0L L4 1984cc 121 CID	2014	Executive, Komfort, Sport; Electric Water Pump	US11008
2.0L L4 1984cc 121 CID	2013	Lux, Sport, Sport Plus; Electric Water Pump	US11008	2.0L L4 1984cc 121 CID	2014	Executive, Final Edition, Komfort; Pump only	US9047
2.0L L4 1984cc 121 CID	2014	Executive, R-Line, Sport; Electric Water Pump	US11008	2.0L L4 1984cc 121 CID	2015	Executive, Final Edition, Komfort; Includes back housing	US9047-2
2.0L L4 1984cc 121 CID	2014-2015	Executive, R-Line, Sport; Pump only	US9047	2.0L L4 1984cc 121 CID	2015	Executive, Final Edition, Komfort; With back plate housing	US9047-2
2.0L L4 1984cc 121 CID	2014-2015	Executive, R-Line, Sport; Includes back housing	US9047-2	2.0L L4 1984cc 121 CID	2015	Komfort; Pump only	US9047
2.0L L4 1984cc 121 CID	2014-2015	Executive, R-Line, Sport; With back plate housing	US9047-2	2.0L L4 1984cc 121 CID	2016	Komfort; Includes back housing	US9047-2
2.0L L4 1984cc 121 CID	2016	R-Line, R-Line Executive, Sport, Trend; Pump only	US9047	3.2L V6 3189cc 195 CID	2007	3.2	US9471
2.0L L4 1984cc 121 CID	2016	R-Line, R-Line Executive, Sport, Trend; Includes back housing	US9047-2	3.2L V6 3189cc 195 CID	2007	3.2; Electric Water Pump	US11004
2.0L L4 1984cc 121 CID	2017	R-Line Executive, Sport; Pump only	US9047	3.2L V6 3189cc 195 CID	2008	VR6	US9471
2.0L L4 1984cc 121 CID	2017	R-Line Executive, Sport; Includes back housing	US9047-2	3.2L V6 3189cc 195 CID	2008	VR6; Electric Water Pump	US11004
3.6L V6 3597cc 219 CID	2009-2010	VR6, VR6 4Motion, VR6 Sport	US6221	3.2L V6 3197cc 195 CID	2008	VR6	US9471
3.6L V6 3597cc 219 CID	2011	VR6 4Motion	US6221	3.2L V6 3197cc 195 CID	2008	VR6; Electric Water Pump	US11004
3.6L V6 3597cc 219 CID	2012	Executive	US6221	<b>EUROVAN</b>			
3.6L V6 3597cc 219 CID	2013	Lux, VR6 4Motion Executive	US6221	1.9L L4 1896cc 116 CID	2006-2008	Mexican Application	US6212
3.6L V6 3597cc 219 CID	2014	4 Motion	US6221	1.9L L4 1896cc 116 CID	2009	Mexican Application	US9378
3.6L V6 3597cc 219 CID	2015	Executive 4 Motion	US6221	2.4L L5 2370cc 144 CID	1993-1996		US9274
3.6L V6 3597cc 219 CID	2016	V6 Executive 4Motion	US6221	2.4L L5 2390cc 146 CID	1997		US9274
<b>CLASICO</b>				2.5L L5 2459cc 150 CID	1992-1996		US9274
2.0L H4 1984cc 121 CID	2012	Mexican Application	US6022	2.5L L5 2459cc 150 CID	1995	Camper; Electric Water Pump	US11034
				2.5L L5 2461cc 150 CID	2001-2003	Mexican Application	US9262
				2.5L L5 2461cc 150 CID	2001-2004		US9274-20
				2.5L L5 2461cc 150 CID	2004	Mexican Application	US9274
				2.8L V6 2792cc	1997	Camper	US9262
				2.8L V6 2792cc	1997	Camper; Electric Water Pump	US11034
				2.8L V6 2792cc	1999	GLS, MV; Electric Water Pump	US11034



Engine	Years	Application Description	USMW	Engine	Years	Application Description	USMW
<b>VOLKSWAGEN (cont'd.)</b>				<b>VOLKSWAGEN (cont'd.)</b>			
<b>EUROVAN (cont'd.)</b>				<b>GOLF (cont'd.)</b>			
2.8L V6 2792cc	1999-2001	GLS, MV	US9262	2.0L L4 1984cc 121 CID	1998	GL, GTI, K2; Includes back housing	US9065-2
2.8L V6 2792cc	2000	GLS, MV, VR6; Electric Water Pump	US11004	2.0L L4 1984cc 121 CID	1999	GL; (ABA)	US9065
2.8L V6 2792cc	2000	GLS, MV; Electric Water Pump, To Chassis/VIN 70-Y-000 001	US11034	2.0L L4 1984cc 121 CID	1999	Wolfsburg Edition	US9065
2.8L V6 2792cc	2001-2003	GLS, MV; Electric Water Pump	US11004	2.0L L4 1984cc 121 CID	1999	GL; (ABA); Includes back housing	US9065-2
2.8L V6 2792cc	2002	GLS, MV; To Chassis/VIN 70-2-097 000	US9262	2.0L L4 1984cc 121 CID	1999	Wolfsburg Edition; Includes back housing	US9065-2
2.8L V6 2792cc	2002	GLS, MV; From Chassis/VIN 70-2-097 001	US9471	2.0L L4 1984cc 121 CID	1999	GL, GTI; (AEG)	US9377
2.8L V6 2792cc	2003	GLS, MV	US9471	2.0L L4 1984cc 121 CID	1999	GLS	US9377
<b>FOX</b>				2.0L L4 1984cc 121 CID	2000	GL, GLS, GTI GLS	US9377
1.8L L4 1780cc	1987-1988	Base, GL	US9065	2.0L L4 1984cc 121 CID	2001-2003	Mexican Application	US9377
1.8L L4 1780cc	1987-1988	Base, GL; Includes back housing	US9065-2	2.0L L4 1984cc 121 CID	2001-2006	GL, GLS	US9377
1.8L L4 1780cc	1989-1990	Base, GL, GL Sport	US9065	2.0L L4 1984cc 121 CID	2007	Mexican Application	US9377
1.8L L4 1780cc	1989-1990	Base, GL, GL Sport; Includes back housing	US9065-2	2.0L L4 1984cc 121 CID	2012-2013	R	US11017
1.8L L4 1780cc	1991-1993	Base, GL	US9065	2.5L L5 2480cc 151 CID	2010-2014	Base	US6050
1.8L L4 1780cc	1991-1993	Base, GL; Includes back housing	US9065-2	2.8L V6 2792cc	1995-1998	GTI VR6	US9262
<b>GLI</b>				2.8L V6 2792cc	1996-1998	GTI VR6; Electric Water Pump	US11034
2.0L L4 1984cc 121 CID	2007	Mexican Application	US9377	2.8L V6 2792cc	1999	GTI	US9262
<b>GOL</b>				2.8L V6 2792cc	1999	GTI; Electric Water Pump	US11034
1.6L L4 1598cc 98 CID	2009-2011		US8949	2.8L V6 2792cc	2000-2001	GTI GLX	US9262
1.6L L4 1598cc 98 CID	2012	GT	US8949	2.8L V6 2792cc	2000-2001	GTI GLX; Electric Water Pump	US11004
1.6L L4 1598cc 98 CID	2013	Comfortline	US8949	2.8L V6 2792cc	2000-2001	GTI GLX; Brazil Built Vehicle, Electric Water Pump	US11034
1.6L L4 1599cc 98 CID	2011-2013	Mexican Application	US8949	2.8L V6 2792cc	2002	GTI VR6; (AFP)	US9262
1.6L L4 1600cc 98 CID	2009-2010	Mexican Application	US8949	2.8L V6 2792cc	2002	GTI VR6; (BDF)	US9471
<b>GOLF</b>				2.8L V6 2792cc	2002	GTI VR6; Electric Water Pump	US11034
1.4L L4 1390cc 85 CID	2013	Mexican Application	US8952	2.8L V6 2792cc	2002-2005	GTI VR6; Electric Water Pump	US11004
1.4L L4 1390cc 85 CID	2015-2016	Mexican Application	US8952	2.8L V6 2792cc	2003-2005	GTI VR6	US9471
1.6L L4 1588cc 97 CID	1985-1986	Base	US9065	3.2L V6 3189cc	2004	R32	US9471
1.6L L4 1588cc 97 CID	1985-1986	Base; Includes back housing	US9065-2	3.2L V6 3189cc	2004	R32; Electric Water Pump	US11004
1.6L L4 1588cc 97 CID	1987-1988	GL	US9065	<b>GOLF ALLTRACK</b>			
1.6L L4 1588cc 97 CID	1987-1988	GL; Includes back housing	US9065-2	1.8L L4 1798cc 110 CID	2017	S, SE, SEL	US8124
1.8L L4 1780cc	1985-1986	Base, GTI	US9065	<b>GOLF SPORTWAGEN</b>			
1.8L L4 1780cc	1985-1986	Base, GTI; Includes back housing	US9065-2	1.8L L4 1798cc 110 CID	2015-2017	S, SE, SEL	US8124
1.8L L4 1780cc	1987	GL, GT, GTI, GTI 16-Valve	US9065	<b>GOL SEDAN</b>			
1.8L L4 1780cc	1987	GL, GT, GTI, GTI 16-Valve; Includes back housing	US9065-2	1.6L L4 1598cc 98 CID	2011	Comfortline, Sport, Trendline	US8949
1.8L L4 1780cc	1988	Base, GL, GT, GTI 16-Valve	US9065	<b>GTI</b>			
1.8L L4 1780cc	1988	Base, GL, GT, GTI 16-Valve; Includes back housing	US9065-2	2.0L L4 1984cc 121 CID	2006	Base	US6022
1.8L L4 1780cc	1989	Base, GL, GTI 16-Valve	US9065	2.0L L4 1984cc 121 CID	2006	Base	US11017
1.8L L4 1780cc	1989	Base, GL, GTI 16-Valve; Includes back housing	US9065-2	2.0L L4 1984cc 121 CID	2007	Base, Fahrenheit	US6022
1.8L L4 1780cc	1990-1992	GL, GTI 8-Valve	US9065	2.0L L4 1984cc 121 CID	2007	Base, Fahrenheit	US11017
1.8L L4 1780cc	1990-1992	GL, GTI 8-Valve; Includes back housing	US9065-2	2.0L L4 1984cc 121 CID	2008	Base; (BPY)	US6022
1.8L L4 1781cc	2000-2001	GLS, GTI GLS	US9377	2.0L L4 1984cc 121 CID	2008	Base; (CBFA); Pump only	US9047
1.8L L4 1781cc	2002	GTI 1.8T, GTI 337	US9377	2.0L L4 1984cc 121 CID	2008	Base; (CCTA); Pump only	US9047
1.8L L4 1781cc	2002	GTI 1.8T, GTI 337; Electric Water Pump	US11003	2.0L L4 1984cc 121 CID	2008	Base; (CBFA); With back plate housing	US9047-2
1.8L L4 1781cc	2003	GTI 1.8T, GTI 20th Anniversary	US9377	2.0L L4 1984cc 121 CID	2008	Base; (CCTA); With back plate housing	US11017
1.8L L4 1781cc	2003	GTI 1.8T, GTI 20th Anniversary; Electric Water Pump	US11003	2.0L L4 1984cc 121 CID	2008-2013	Base; Electric Water Pump	US11008
1.8L L4 1781cc	2004-2006	GTI 1.8T	US9377	2.0L L4 1984cc 121 CID	2009-2010	Base; Pump only	US9047
1.8L L4 1781cc	2004-2006	GTI 1.8T; Electric Water Pump	US11003	2.0L L4 1984cc 121 CID	2009-2010	Base; With back plate housing	US9047-2
1.8L L4 1781cc 109 CID	1998-1999	Mexican Application	US9065	2.0L L4 1984cc 121 CID	2011	Base; Pump only, To 10/31/2010	US9047
1.8L L4 1798cc 110 CID	2015	Launch Edition, S, SE, SEL	US8124	2.0L L4 1984cc 121 CID	2011	Base; To 10/31/2010, With back plate housing	US9047-2
1.8L L4 1798cc 110 CID	2016	Base, S, SE, SEL	US8124	2.0L L4 1984cc 121 CID	2013	Base; Pump only	US9047
1.8L L4 1798cc 110 CID	2017	S, Wolfsburg Edition	US8124	2.0L L4 1984cc 121 CID	2013	Base; With back plate housing	US9047-2
1.8L L4 1800cc 110 CID	1987-1997	Mexican Application	US9065	2.0L L4 1984cc 121 CID	2014	Driver's Edition, Wolfsburg Edition; Pump only	US9047
1.9L L4 1896cc 116 CID	1999	GL, TDI	US9378	2.0L L4 1984cc 121 CID	2014	Driver's Edition, Wolfsburg Edition; Includes back housing	US9047-2
1.9L L4 1896cc 116 CID	2000-2003	GL, GLS	US9378	2.0L L4 1984cc 121 CID	2014	Driver's Edition, Wolfsburg Edition; With back plate housing	US9047-2
1.9L L4 1896cc 116 CID	2004	GLS TDI, GL TDI; (BEW)	US6034	2.0L L4 1984cc 121 CID	2014	Wolfsburg Edition; Electric Water Pump	US11008
1.9L L4 1896cc 116 CID	2004	GLS TDI, GL TDI; (ALH)	US9378	2.0L L4 1984cc 121 CID	2015-2016	Autobahn, S, SE	US8124
1.9L L4 1896cc 116 CID	2005	TDI	US6034	2.0L L4 1984cc 121 CID	2017	Autobahn, S, SE, Sport	US8124
1.9L L4 1896cc 116 CID	2006	GLS TDI	US6034	<b>JETTA</b>			
2.0L L4 1968cc 120 CID	2010-2011	TDI	US6034	1.4L L4 1395cc 85 CID	2013-2016	Mexican Application	US8952
2.0L L4 1968cc 120 CID	2012	TDI; From 04/28/2012	US6034	1.6L L4 1588cc 97 CID	1980	Base	US9066
2.0L L4 1968cc 120 CID	2012	TDI; To 04/28/2012	US6034	1.6L L4 1588cc 97 CID	1981	Base, Special Edition	US9066
2.0L L4 1984cc 121 CID	1990-1992	GTI 16-Valve	US9065	1.6L L4 1588cc 97 CID	1982	Base; From Chassis/VIN 630001	US9065
2.0L L4 1984cc 121 CID	1990-1992	GTI 16-Valve; Includes back housing	US9065-2	1.6L L4 1588cc 97 CID	1982	Base; From Chassis/VIN 630001, Includes back housing	US9065-2
2.0L L4 1984cc 121 CID	1993	GL	US9065	1.6L L4 1588cc 97 CID	1982	Base; To Chassis/VIN 630000	US9066
2.0L L4 1984cc 121 CID	1993	GL; Includes back housing	US9065-2	1.6L L4 1588cc 97 CID	1983	Base	US9065
2.0L L4 1984cc 121 CID	1994	GL, GTI, Limited Edition	US9065	1.6L L4 1588cc 97 CID	1983	Base; Includes back housing	US9065-2
2.0L L4 1984cc 121 CID	1994	GL, GTI, Limited Edition; Includes back housing	US9065-2	1.6L L4 1588cc 97 CID	1984-1986	Base, GL	US9065
2.0L L4 1984cc 121 CID	1995	Celebration Edition, City, GL, Sport	US9065	1.6L L4 1588cc 97 CID	1984-1986	Base, GL; Includes back housing	US9065-2
2.0L L4 1984cc 121 CID	1995	Celebration Edition, City, GL, Sport; Includes back housing	US9065-2	1.6L L4 1588cc 97 CID	1987	Base, GL, Wolfsburg Edition	US9065
2.0L L4 1984cc 121 CID	1996	GL, GTI	US9065	1.6L L4 1588cc 97 CID	1987	Base, GL, Wolfsburg Edition; Includes back housing	US9065-2
2.0L L4 1984cc 121 CID	1996	GL, GTI; Includes back housing	US9065-2	1.6L L4 1588cc 97 CID	1989	Base	US9065
2.0L L4 1984cc 121 CID	1997	GL, GTI, Jazz, K2, Trek	US9065	1.6L L4 1588cc 97 CID	1989	Base; Includes back housing	US9065-2
2.0L L4 1984cc 121 CID	1997	GL, GTI, Jazz, K2, Trek; Includes back housing	US9065-2	1.6L L4 1588cc 97 CID	1990-1992	GL	US9065
2.0L L4 1984cc 121 CID	1998	GL, GTI, K2	US9065	1.6L L4 1588cc 97 CID	1990-1992	GL; Includes back housing	US9065-2
				1.7L L4 1715cc	1981	Base, Special Edition	US9065

WATER PUMPS



# WATER PUMP APPLICATION GUIDE



Engine	Years	Application Description	USMWW	Engine	Years	Application Description	USMWW
<b>VOLKSWAGEN (cont'd.)</b>				<b>VOLKSWAGEN (cont'd.)</b>			
<b>JETTA (cont'd.)</b>				<b>JETTA (cont'd.)</b>			
1.7L L4 1715cc	1981	Base, Special Edition; Includes back housing	<b>US9065-2</b>	2.0L L4 1984cc 121 CID	1996	GL, GLS, Trek, Wolfsburg Edition	<b>US9065</b>
1.7L L4 1715cc	1982	Base	<b>US9065</b>	2.0L L4 1984cc 121 CID	1996	GL, GLS, Trek, Wolfsburg Edition; Includes back housing	<b>US9065-2</b>
1.7L L4 1715cc	1982	Base; Includes back housing	<b>US9065-2</b>	2.0L L4 1984cc 121 CID	1997	GL, GLS, GT, Jazz	<b>US9065</b>
1.7L L4 1715cc	1983	Base, Wolfsburg Edition	<b>US9065</b>	2.0L L4 1984cc 121 CID	1997	GL, GLS, GT, Jazz; Includes back housing	<b>US9065-2</b>
1.7L L4 1715cc	1983	Base, Wolfsburg Edition; Includes back housing	<b>US9065-2</b>	2.0L L4 1984cc 121 CID	1998	GL, GLS, GT, K2, Wolfsburg Edition	<b>US9065</b>
1.7L L4 1715cc	1984	Base, GL	<b>US9065</b>	2.0L L4 1984cc 121 CID	1998	GL, GLS, GT, K2, Wolfsburg Edition; Includes back housing	<b>US9065-2</b>
1.7L L4 1715cc	1984	Base, GL; Includes back housing	<b>US9065-2</b>	2.0L L4 1984cc 121 CID	1999	GL, GLS; (ABA)	<b>US9065</b>
1.8L L4 1780cc	1984-1986	Base, GL, GLI	<b>US9065</b>	2.0L L4 1984cc 121 CID	1999	Wolfsburg Edition	<b>US9065</b>
1.8L L4 1780cc	1984-1986	Base, GL, GLI; Includes back housing	<b>US9065-2</b>	2.0L L4 1984cc 121 CID	1999	GL, GLS; (ABA); Includes back housing	<b>US9065-2</b>
1.8L L4 1780cc	1987	Base, GL, GLI, GLI 16-Valve, Wolfsburg Edition; Germany Built Vehicle	<b>US9065</b>	2.0L L4 1984cc 121 CID	1999	Wolfsburg Edition; Includes back housing	<b>US9065-2</b>
1.8L L4 1780cc	1987	Base, GL, GLI, GLI 16-Valve, Wolfsburg Edition; USA Built	<b>US9065</b>	2.0L L4 1984cc 121 CID	1999	GL; (AEG)	<b>US9377</b>
1.8L L4 1780cc	1987	Base, GL, GLI, Wolfsburg Edition	<b>US9065</b>	2.0L L4 1984cc 121 CID	1999	GLS; (-), (AEG)	<b>US9377</b>
1.8L L4 1780cc	1987	Base, GL, GLI, GLI 16-Valve, Wolfsburg Edition; Germany Built Vehicle, Includes back housing	<b>US9065-2</b>	2.0L L4 1984cc 121 CID	2000-2005	GL, GLS	<b>US9377</b>
1.8L L4 1780cc	1987	Base, GL, GLI, GLI 16-Valve, Wolfsburg Edition; Includes back housing	<b>US9065-2</b>	2.0L L4 1984cc 121 CID	2006-2007	2.0T, GLI	<b>US6022</b>
1.8L L4 1780cc	1987	Base, GL, GLI, GLI 16-Valve, Wolfsburg Edition; Includes back housing, USA Built	<b>US9065-2</b>	2.0L L4 1984cc 121 CID	2006-2007	2.0T, GLI	<b>US11017</b>
1.8L L4 1780cc	1987	Base, GL, GLI, Wolfsburg Edition; Includes back housing	<b>US9065-2</b>	2.0L L4 1984cc 121 CID	2006-2010	Mexican Application	<b>US9377</b>
1.8L L4 1780cc	1987	Base, GL, GLI, Wolfsburg Edition; Includes back housing	<b>US9065-2</b>	2.0L L4 1984cc 121 CID	2008	GLI, Wolfsburg Edition; (BPY)	<b>US6022</b>
1.8L L4 1780cc	1988-1989	Base, Carat, GL	<b>US9065</b>	2.0L L4 1984cc 121 CID	2008	GLI, Wolfsburg Edition; (CBFA); Pump only	<b>US9047</b>
1.8L L4 1780cc	1988-1989	Base, Carat, GL, GLI 16-Valve; Germany Built Vehicle	<b>US9065</b>	2.0L L4 1984cc 121 CID	2008	GLI, Wolfsburg Edition; (CCTA); Pump only	<b>US9047</b>
1.8L L4 1780cc	1988-1989	Base, Carat, GL, GLI 16-Valve; USA Built	<b>US9065</b>	2.0L L4 1984cc 121 CID	2008	GLI, Wolfsburg Edition; (CBFA); With back plate housing	<b>US9047-2</b>
1.8L L4 1780cc	1988-1989	Base, Carat, GL, GLI 16-Valve; Germany Built Vehicle, Includes back housing	<b>US9065-2</b>	2.0L L4 1984cc 121 CID	2008	GLI, Wolfsburg Edition; (CCTA); With back plate housing	<b>US9047-2</b>
1.8L L4 1780cc	1988-1989	Base, Carat, GL, GLI 16-Valve; Includes back housing, USA Built	<b>US9065-2</b>	2.0L L4 1984cc 121 CID	2008	GLI, Wolfsburg Edition; Electric Water Pump	<b>US11008</b>
1.8L L4 1780cc	1988-1989	Base, Carat, GL; Includes back housing	<b>US9065-2</b>	2.0L L4 1984cc 121 CID	2008	GLI, Wolfsburg Edition	<b>US11017</b>
1.8L L4 1780cc	1988-1989	Base, Carat, GL, GLI 16-Valve; Mexico Built Vehicle	<b>US9065</b>	2.0L L4 1984cc 121 CID	2009	GLI, SEL, Wolfsburg Edition; Pump only	<b>US9047</b>
1.8L L4 1780cc	1989	Base, Carat, GL, GLI 16-Valve; Includes back housing, Mexico Built Vehicle	<b>US9065-2</b>	2.0L L4 1984cc 121 CID	2009	GLI, SEL, Wolfsburg Edition; With back plate housing	<b>US9047-2</b>
1.8L L4 1780cc	1989	Base, Carat, GL, GLI 16-Valve; Includes back housing, Mexico Built Vehicle	<b>US9065-2</b>	2.0L L4 1984cc 121 CID	2009	SEL, Wolfsburg Edition; Electric Water Pump	<b>US11008</b>
1.8L L4 1780cc	1990-1992	Carat, GL	<b>US9065</b>	2.0L L4 1984cc 121 CID	2010	Wolfsburg Edition; Pump only	<b>US9047</b>
1.8L L4 1780cc	1990-1992	Carat, GL; Includes back housing	<b>US9065-2</b>	2.0L L4 1984cc 121 CID	2010	Wolfsburg Edition; With back plate housing	<b>US9047-2</b>
1.8L L4 1780cc 108 CID	1998-1999	Mexican Application	<b>US9066</b>	2.0L L4 1984cc 121 CID	2010	Wolfsburg Edition; Electric Water Pump	<b>US11008</b>
1.8L L4 1781cc	2000	GLS	<b>US9377</b>	2.0L L4 1984cc 121 CID	2011	Base, S	<b>US9377</b>
1.8L L4 1781cc	2001	GLS, Wolfsburg Edition	<b>US9377</b>	2.0L L4 1984cc 121 CID	2012	GLI; From 06/01/2012, Pump only	<b>US9047</b>
1.8L L4 1781cc	2002	GLS	<b>US9377</b>	2.0L L4 1984cc 121 CID	2012	GLI; Pump only, To 05/31/2012	<b>US9047</b>
1.8L L4 1781cc	2002	GLS; Electric Water Pump	<b>US11003</b>	2.0L L4 1984cc 121 CID	2012	GLI; From 06/01/2012, With back plate housing	<b>US9047-2</b>
1.8L L4 1781cc	2003	GL, GLS, Wolfsburg Edition	<b>US9377</b>	2.0L L4 1984cc 121 CID	2012	GLI; To 05/31/2012, With back plate housing	<b>US9047-2</b>
1.8L L4 1781cc	2003	GL, GLS, Wolfsburg Edition; Electric Water Pump	<b>US11003</b>	2.0L L4 1984cc 121 CID	2012-2013	GLI; Electric Water Pump	<b>US11008</b>
1.8L L4 1781cc	2004-2005	GL, GLI, GLS	<b>US9377</b>	2.0L L4 1984cc 121 CID	2012-2014	S	<b>US9377</b>
1.8L L4 1781cc	2004-2005	GL, GLI, GLS; Electric Water Pump	<b>US11003</b>	2.0L L4 1984cc 121 CID	2013	GLI; Pump only	<b>US9047</b>
1.8L L4 1781cc 109 CID	2009	Mexican Application	<b>US9377</b>	2.0L L4 1984cc 121 CID	2013	GLI; With back plate housing	<b>US9047-2</b>
1.8L L4 1798cc 110 CID	2015	SE, SEL, Sport; From 07/01/2014	<b>US8124</b>	2.0L L4 1984cc 121 CID	2013	Mexican Application	<b>US9377</b>
1.8L L4 1798cc 110 CID	2016	SEL, SEL Premium, Sport	<b>US8124</b>	2.0L L4 1984cc 121 CID	2013	Base, S	<b>US9377</b>
1.8L L4 1798cc 110 CID	2017	SEL, Sport	<b>US8124</b>	2.0L L4 1984cc 121 CID	2015	GLI SE, GLI SEL	<b>US8124</b>
1.8L L4 1800cc 110 CID	1987-1997	Mexican Application	<b>US9065</b>	2.0L L4 1984cc 121 CID	2015-2016	GLI	<b>US8124</b>
1.9L L4 1896cc 116 CID	1997-1998	TDI	<b>US9065</b>	2.0L L4 1984cc 121 CID	2017	2.5	<b>US6050</b>
1.9L L4 1896cc 116 CID	1997-1998	TDI; Includes back housing	<b>US9065-2</b>	2.5L L5 2480cc 151 CID	2005	2.5, Value Edition	<b>US6050</b>
1.9L L4 1896cc 116 CID	1999	TDI; (AHU)	<b>US9065</b>	2.5L L5 2480cc 151 CID	2006	2.5, Wolfsburg Edition	<b>US6050</b>
1.9L L4 1896cc 116 CID	1999	TDI; (AHU); Includes back housing	<b>US9065-2</b>	2.5L L5 2480cc 151 CID	2007	S, SE, SEL	<b>US6050</b>
1.9L L4 1896cc 116 CID	1999	TDI; (ALH)	<b>US9378</b>	2.5L L5 2480cc 151 CID	2008-2013	Mexican Application	<b>US6050</b>
1.9L L4 1896cc 116 CID	2000-2003	TDI	<b>US9378</b>	2.5L L5 2480cc 151 CID	2011-2014	S, SE	<b>US6050</b>
1.9L L4 1896cc 116 CID	2004	TDI; (BEW)	<b>US6034</b>	2.5L L5 2480cc 151 CID	2014	GLX; Electric Water Pump, Germany Built Vehicle	<b>US11034</b>
1.9L L4 1896cc 116 CID	2004	TDI; (ALH)	<b>US9378</b>	2.8L V6 2792cc	1994	GLX	<b>US9262</b>
1.9L L4 1896cc 116 CID	2005	GLS TDI, GL TDI	<b>US6034</b>	2.8L V6 2792cc	1994-1998	GLX; Electric Water Pump	<b>US11034</b>
1.9L L4 1896cc 116 CID	2005-2006	TDI	<b>US6212</b>	2.8L V6 2792cc	1999	GLS, GLX; Electric Water Pump	<b>US11034</b>
1.9L L4 1896cc 116 CID	2007	Mexican Application	<b>US6212</b>	2.8L V6 2792cc	1999-2001	GLS, GLX	<b>US9262</b>
1.9L L4 1896cc 116 CID	2008	Mexican Application	<b>US9378</b>	2.8L V6 2792cc	2000-2001	GLS, GLX; Electric Water Pump	<b>US11004</b>
1.9L L4 1896cc 116 CID	2009	Mexican Application	<b>US6034</b>	2.8L V6 2792cc	2002	GLS, GLX; (AFP)	<b>US9262</b>
1.9L L4 1896cc 116 CID	2010	Mexican Application	<b>US6212</b>	2.8L V6 2792cc	2002	GLI	<b>US9471</b>
2.0L H4 1984cc 121 CID	2010	Mexican Application	<b>US6022</b>	2.8L V6 2792cc	2002	GLS, GLX; (BDF)	<b>US9471</b>
2.0L L4 1968cc 120 CID	2009	TDI	<b>US6034</b>	2.8L V6 2792cc	2002	GLI, GLS, GLX; Electric Water Pump	<b>US11004</b>
2.0L L4 1968cc 120 CID	2010	TDI, TDI Cup Edition	<b>US6034</b>	2.8L V6 2792cc	2003	GLI, GLX	<b>US9471</b>
2.0L L4 1968cc 120 CID	2011	TDI	<b>US6034</b>	2.8L V6 2792cc	2003	GLI, GLX; Electric Water Pump	<b>US11004</b>
2.0L L4 1968cc 120 CID	2012	TDI, TDI Premium	<b>US6034</b>	2.8L V6 2792cc	2004	GLI	<b>US9471</b>
2.0L L4 1968cc 120 CID	2013	TDI, TDI Premium; From 04/28/2012	<b>US6034</b>	2.8L V6 2792cc	2004	GLS; Electric Water Pump	<b>US11004</b>
2.0L L4 1968cc 120 CID	2013	TDI, TDI Premium; To 04/28/2012	<b>US6034</b>	2.8L V6 2792cc	2004		
2.0L L4 1968cc 120 CID	2014	TDI, TDI Premium	<b>US6034</b>				
2.0L L4 1984cc 121 CID	1990-1992	GLI 16-Valve	<b>US9065</b>	<b>LUPO</b>			
2.0L L4 1984cc 121 CID	1990-1992	GLI 16-Valve; Includes back housing	<b>US9065-2</b>	1.6L L4 1599cc 98 CID	2005-2009		<b>US8949</b>
2.0L L4 1984cc 121 CID	1993	GL	<b>US9065</b>	1.6L L4 1600cc 98 CID	2005-2009	Mexican Application	<b>US8949</b>
2.0L L4 1984cc 121 CID	1993	GL; Includes back housing	<b>US9065-2</b>	<b>PANEL</b>			
2.0L L4 1984cc 121 CID	1994	GL, GLS, Limited Edition	<b>US9065</b>	1.8L L4 1780cc 108 CID	1998-2001	Mexican Application	<b>US9065</b>
2.0L L4 1984cc 121 CID	1994	GL, GLS, Limited Edition; Includes back housing	<b>US9065-2</b>	1.8L L4 1800cc 110 CID	1988-1997	Mexican Application	<b>US9065</b>
2.0L L4 1984cc 121 CID	1995	Celebration Edition, City, GL, GLS	<b>US9065</b>	<b>PASSAT</b>			
2.0L L4 1984cc 121 CID	1995	Celebration Edition, City, GL, GLS; Includes back housing	<b>US9065-2</b>	1.8L L4 1781cc	1998-1999	GLS	<b>US9401</b>



Engine	Years	Application Description	USMW	Engine	Years	Application Description	USMW
<b>VOLKSWAGEN (cont'd.)</b>				<b>VOLKSWAGEN (cont'd.)</b>			
<b>PASSAT (cont'd.)</b>				<b>QUANTUM (cont'd.)</b>			
1.8L L4 1781cc	2000	GLS; (AUG)	US9377	1.6L L4 1588cc 97 CID	1984	GL; Includes back housing	US9065-2
1.8L L4 1781cc	2000	GLS; (ATW)	US9401	1.6L L4 1588cc 97 CID	1985	Base, GL	US9065
1.8L L4 1781cc	2001-2002	GLS	US9377	1.6L L4 1588cc 97 CID	1985	Base, GL; Includes back housing	US9065-2
1.8L L4 1781cc	2003	GL, GLS	US9377	1.7L L4 1715cc	1982-1983	Base, GL	US9065
1.8L L4 1781cc	2004-2005	GL, GLS, GLS 4 Motion	US9377	1.7L L4 1715cc	1982-1983	Base, GL; Includes back housing	US9065-2
1.8L L4 1798cc 110 CID	2014	S, SE, SEL Premium, Wolfsburg Edition	US8124	1.8L L4 1780cc	1984	GL	US9065
1.8L L4 1798cc 110 CID	2015	Limited Edition, S, SE, SEL Premium, Sport, Wolfsburg Edition	US8124	1.8L L4 1780cc	1984	GL; Includes back housing	US9065-2
1.8L L4 1798cc 110 CID	2016	R-Line, S, SE, SEL, SEL Premium	US8124	1.8L L4 1780cc	1985	Base, GL	US9065
1.8L L4 1798cc 110 CID	2017	R-Line, S, SE, SEL Premium	US8124	1.8L L4 1780cc	1985	Base, GL; Includes back housing	US9065-2
1.9L L4 1896cc 116 CID	1996-1997	TDI	US9065	2.2L L5 2144cc	1983	Base, GL	US9052
1.9L L4 1896cc 116 CID	1996-1997	TDI; Includes back housing	US9065-2	2.2L L5 2144cc	1984	GL	US9052
2.0L H4 1985cc 121 CID	2010	Mexican Application	US6022	2.2L L5 2226cc	1985	Base, GL	US9052
2.0L L4 1967cc 120 CID	2004-2005	GLS TDI, GL TDI	US6034	2.2L L5 2226cc	1986-1987	Base, GL, Syncro	US9052
2.0L L4 1968cc 120 CID	2014	TDI SE, TDI SEL Premium	US8108	2.2L L5 2226cc	1988	GL, Syncro	US9052
2.0L L4 1984cc 121 CID	1990-1991	GL	US9065	<b>R32</b>			
2.0L L4 1984cc 121 CID	1990-1991	GL; Includes back housing	US9065-2	3.2L V6 3189cc 195 CID	2008	Base	US9471
2.0L L4 1984cc 121 CID	1992	CL, GL	US9065	3.2L V6 3189cc 195 CID	2008	Base; Electric Water Pump	US11004
2.0L L4 1984cc 121 CID	1992	CL, GL; Includes back housing	US9065-2	<b>RABBIT</b>			
2.0L L4 1984cc 121 CID	1993	GL	US9065	1.5L L4 1457cc	1978-1979		US9066
2.0L L4 1984cc 121 CID	1993	GL; Includes back housing	US9065-2	1.5L L4 1457cc	1980	Base, Custom, Deluxe	US9066
2.0L L4 1984cc 121 CID	1995-1996	GLS	US9065	1.5L L4 1471cc	1975		US9066
2.0L L4 1984cc 121 CID	1995-1996	GLS; Includes back housing	US9065-2	1.5L L4 1471cc	1977-1979		US9066
2.0L L4 1984cc 121 CID	2006	2.0T, Value Edition	US6022	1.5L L4 1471cc	1980	Base, Custom, Deluxe	US9066
2.0L L4 1984cc 121 CID	2006	2.0T, Value Edition	US11017	1.6L L4 1588cc 97 CID	1976-1977		US9066
2.0L L4 1984cc 121 CID	2007	2.0T, Value Edition, Wolfsburg Edition	US6022	1.6L L4 1588cc 97 CID	1980	Base, Custom, Deluxe	US9066
2.0L L4 1984cc 121 CID	2007	2.0T, Value Edition, Wolfsburg Edition	US11017	1.6L L4 1588cc 97 CID	1981	L Custom, Ls Deluxe	US9066
2.0L L4 1984cc 121 CID	2008	Komfort, Lux, Turbo; (BPY)	US6022	1.6L L4 1588cc 97 CID	1982	L, LS	US9066
2.0L L4 1984cc 121 CID	2008	Komfort, Lux, Turbo; (CCTA); Pump only	US9047	1.6L L4 1588cc 97 CID	1983	L, LS, Wolfsburg Edition; 30mm Hub	US9065
2.0L L4 1984cc 121 CID	2008	Komfort, Lux, Turbo; (CCTA); With back plate housing	US9047-2	1.6L L4 1588cc 97 CID	1983	L, LS, Wolfsburg Edition; 30mm Hub, Includes back housing	US9065-2
2.0L L4 1984cc 121 CID	2008	Komfort, Lux, Turbo; Electric Water Pump	US11008	1.6L L4 1588cc 97 CID	1984	L, LS, Wolfsburg Edition; 40mm Hub	US9066
2.0L L4 1984cc 121 CID	2008	Komfort, Lux, Turbo	US11017	1.6L L4 1588cc 97 CID	1984	L; Includes back housing	US9065-2
2.0L L4 1984cc 121 CID	2009-2010	Komfort; Pump only	US9047	1.7L L4 1715cc	1981	Base, L, LS, S; 30mm Hub, With air cond.	US9065
2.0L L4 1984cc 121 CID	2009-2010	Komfort; With back plate housing	US9047-2	1.7L L4 1715cc	1981	Base, L, LS, S; 30mm Hub, Includes back housing, With air cond.	US9065-2
2.0L L4 1984cc 121 CID	2009-2010	Komfort; Electric Water Pump	US11008	1.7L L4 1715cc	1981	Base, L, LS, S; 40mm Hub, Exc.Air Cond	US9066
2.5L L5 2480cc 151 CID	2012	S, SE, SEL, SEL Premium	US6050	1.7L L4 1715cc	1982	Base, L, Limited Edition, LS, S; 30mm Hub	US9065
2.5L L5 2480cc 151 CID	2013	S, SE, SEL, SEL Premium, Wolfsburg Edition	US6050	1.7L L4 1715cc	1982	Base, L, Limited Edition, LS, S; 30mm Hub, With air cond.	US9065
2.5L L5 2480cc 151 CID	2014	S, SE, Wolfsburg Edition	US6050	1.7L L4 1715cc	1982	Base, L, Limited Edition, LS, S; 30mm Hub, Includes back housing	US9065-2
2.8L V6 2771cc	1998-1999	GLS, GLX	US9333	1.7L L4 1715cc	1982	Base, L, Limited Edition, LS, S; 30mm Hub, Includes back housing, With air cond.	US9065-2
2.8L V6 2771cc	2000	4 Motion, GLS, GLX	US9333	1.7L L4 1715cc	1982	Base, L, Limited Edition, LS, S; 30mm Hub, Includes back housing, With air cond.	US9065-2
2.8L V6 2771cc	2001-2002	GLS, GLS 4 Motion, GLX, GLX 4 Motion	US9333	1.7L L4 1715cc	1982	Base, L, Limited Edition, LS, S; 40mm Hub	US9066
2.8L V6 2771cc	2003-2004	GL, GLS, GLX, GLX 4 Motion	US9333	1.7L L4 1715cc	1982	Base, L, Limited Edition, LS, S; 40mm Hub, Exc.Air Cond	US9066
2.8L V6 2771cc	2005	GLS, GLS 4 Motion, GLX, GLX 4 Motion	US9333	1.7L L4 1715cc	1983	GL, L, LS, Wolfsburg Edition; 30mm Hub	US9065
2.8L V6 2771cc 170 CID	2000	GLX	US9333	1.7L L4 1715cc	1983	GL, L, LS, Wolfsburg Edition; 30mm Hub, With air cond.	US9065
2.8L V6 2788cc 170 CID	1997	Mexican Application	US9262	1.7L L4 1715cc	1983	GL, L, LS, Wolfsburg Edition; 30mm Hub, Includes back housing	US9065-2
2.8L V6 2792cc	1993-1994	GLX; Electric Water Pump	US11034	1.7L L4 1715cc	1983	GL, L, LS, Wolfsburg Edition; 30mm Hub, Includes back housing, With air cond.	US9065-2
2.8L V6 2792cc	1993-1997	GLX	US9262	1.7L L4 1715cc	1983	GL, L, LS, Wolfsburg Edition; 30mm Hub, Includes back housing, With air cond.	US9065-2
3.6L V6 3597cc 219 CID	2006-2007	3.6	US6221	1.7L L4 1715cc	1983	GL, L, LS, Wolfsburg Edition; 40mm Hub	US9066
3.6L V6 3597cc 219 CID	2008	VR6	US6221	1.7L L4 1715cc	1983	GL, L, LS, Wolfsburg Edition; 40mm Hub, Exc.Air Cond	US9066
3.6L V6 3597cc 219 CID	2009	Mexican Application	US6221	1.7L L4 1715cc	1984	L; 30mm Hub	US9065
3.6L V6 3597cc 219 CID	2012-2015	SE, SEL Premium	US6221	1.7L L4 1715cc	1984	L; 30mm Hub, With air cond.	US9065
3.6L V6 3597cc 219 CID	2016	SEL Premium	US6221	1.7L L4 1715cc	1984	L; 30mm Hub, Includes back housing	US9065-2
3.6L V6 3597cc 219 CID	2017	SE, SEL Premium	US6221	1.7L L4 1715cc	1984	L; 30mm Hub, Includes back housing, With air cond.	US9065-2
4.0L W8 3998cc 244 CID	2002-2004	W8	US8111	1.7L L4 1715cc	1984	L; 30mm Hub, Includes back housing, With air cond.	US9065-2
4.0L W8 3998cc 244 CID	2002-2004		US11004	1.7L L4 1715cc	1984	L; 30mm Hub, Includes back housing, With air cond.	US9065-2
<b>PHAETON</b>				<b>RABBIT CONVERTIBLE</b>			
4.2L V8 4172cc	2004-2006	V8	US9410	1.6L L4 1588cc 97 CID	1980	Base	US9066
6.0L W12 5998cc	2005	W12	US8111	1.7L L4 1715cc	1981	Base; With air cond.	US9065
6.0L W12 5998cc 366 CID	2006	W12	US8111	1.7L L4 1715cc	1981	Base; Includes back housing, With air cond.	US9065-2
6.0L W12 5998cc 366 CID	2006	W12; Electric Water Pump	US11004	1.7L L4 1715cc	1981	Base; Exc.Air Cond	US9066
6.0L W12 6000cc	2004	W12	US8111	1.7L L4 1715cc	1982	Base	US9065
6.0L W12 6000cc	2004	W12; Electric Water Pump	US11004	1.7L L4 1715cc	1982	Base; Includes back housing	US9065-2
<b>POINTER</b>				<b>RABBIT CONVERTIBLE</b>			
1.8L L4 1780cc 108 CID	1998-2002	Mexican Application	US9065	1.6L L4 1588cc 97 CID	1980	Base	US9066
1.8L L4 1780cc 108 CID	1999-2002	Mexican Application	US9066	1.7L L4 1715cc	1981	Base; With air cond.	US9065
1.8L L4 1781cc 109 CID	2003-2009	Mexican Application	US9377	1.7L L4 1715cc	1981	Base; Includes back housing, With air cond.	US9065-2
1.8L L4 1781cc 109 CID	2003-2010	Mexican Application	US9065	1.7L L4 1715cc	1981	Base; Exc.Air Cond	US9066
2.0L L4 1984cc 121 CID	2000-2003	Mexican Application	US9377	1.7L L4 1715cc	1982	Base	US9065
<b>POLO</b>				<b>RABBIT CONVERTIBLE</b>			
1.4L L4 1390cc 85 CID	2013-2014	Mexican Application	US8952	1.7L L4 1715cc	1982	Base; Includes back housing	US9065-2
1.6L L4 1596cc 97 CID	2003-2007		US8949	1.7L L4 1715cc	1983	Base, Wolfsburg Edition	US9065
1.6L L4 1596cc 97 CID	2003-2007	Mexican Application	US8949	1.7L L4 1715cc	1983	Base, Wolfsburg Edition	US9065
2.0L L4 1984cc 121 CID	2003-2007	Mexican Application	US9377	1.7L L4 1715cc	1983	Base, Wolfsburg Edition	US9065
<b>QUANTUM</b>				<b>RABBIT CONVERTIBLE</b>			
1.6L L4 1588cc 97 CID	1982-1983	Base, GL	US9065	1.6L L4 1588cc 97 CID	1980	Base	US9066
1.6L L4 1588cc 97 CID	1982-1983	Base, GL; Includes back housing	US9065-2	1.7L L4 1715cc	1981	Base; With air cond.	US9065
1.6L L4 1588cc 97 CID	1984	GL	US9065	1.7L L4 1715cc	1981	Base; Includes back housing, With air cond.	US9065-2

WATER PUMPS





# WATER PUMP APPLICATION GUIDE



Engine	Years	Application Description	USMW
<b>VOLKSWAGEN (cont'd.)</b>			
<b>RABBIT CONVERTIBLE (cont'd.)</b>			
1.7L L4 1715cc	1983	Base, Wolfsburg Edition; Includes back housing	<b>US9065-2</b>
<b>RABBIT PICKUP</b>			
1.5L L4 1457cc	1980	Base, LX, Sport	<b>US9066</b>
1.6L L4 1588cc 97 CID	1980	Base, LX, Sport	<b>US9066</b>
1.6L L4 1588cc 97 CID	1981-1982	Base, LX, Sport; 40mm Hub	<b>US9066</b>
1.6L L4 1588cc 97 CID	1981-1983	Base, LX, Sport; 30mm Hub	<b>US9065</b>
1.6L L4 1588cc 97 CID	1981-1983	Base, LX, Sport; 30mm Hub, Includes back housing	<b>US9065-2</b>
1.7L L4 1715cc	1981-1982	Base, LX, Sport; 30mm Hub	<b>US9065</b>
1.7L L4 1715cc	1981-1982	Base, LX, Sport; 30mm Hub, Includes back housing	<b>US9065-2</b>
1.7L L4 1715cc	1981-1983	Base, LX, Sport; 40mm Hub	<b>US9066</b>
<b>ROUTAN</b>			
3.6L V6 3604cc 220 CID	2011-2012	S, SE, SEL, SEL Premium	<b>US8981</b>
3.6L V6 3604cc 220 CID	2013-2014	S, SE, SEL Premium	<b>US8981</b>
3.8L V6 3778cc 230 CID	2010	Mexican Application	<b>US6231</b>
3.8L V6 3778cc 231 CID	2009-2010	S, SE	<b>US6231</b>
4.0L V6 3952cc 241 CID	2009	SEL	<b>US8951</b>
4.0L V6 3952cc 241 CID	2010	SEL, SEL Premium	<b>US8951</b>
<b>SCIROCCO</b>			
1.5L L4 1457cc	1978		<b>US9066</b>
1.5L L4 1471cc	1975		<b>US9066</b>
1.6L L4 1588cc 97 CID	1976-1977		<b>US9066</b>
1.6L L4 1588cc 97 CID	1979		<b>US9066</b>
1.6L L4 1588cc 97 CID	1980	Base, S	<b>US9066</b>
1.7L L4 1715cc	1981	Base, S; With air cond.	<b>US9065</b>
1.7L L4 1715cc	1981	Base, S; Includes back housing, With air cond.	<b>US9065-2</b>
1.7L L4 1715cc	1981	Base, S; Exc. Air Cond	<b>US9066</b>
1.7L L4 1715cc	1982-1983	Base, GL	<b>US9065</b>
1.7L L4 1715cc	1982-1983	Base, GL; Includes back housing	<b>US9065-2</b>
1.8L L4 1780cc	1984-1986	Base	<b>US9065</b>
1.8L L4 1780cc	1984-1986	Base; Includes back housing	<b>US9065-2</b>
1.8L L4 1780cc	1987	16-Valve, Base	<b>US9065</b>
1.8L L4 1780cc	1987	16-Valve, Base; Includes back housing	<b>US9065-2</b>
1.8L L4 1780cc	1988	16-Valve	<b>US9065</b>
1.8L L4 1780cc	1988	16-Valve; Includes back housing	<b>US9065-2</b>
<b>SHARAN</b>			
1.8L L4 1781cc 109 CID	2002-2008	Mexican Application	<b>US9377</b>
<b>SPORTVAN</b>			
1.6L L4 1599cc 98 CID	2007-2009		<b>US8949</b>
1.6L L4 1599cc 98 CID	2010	Comfortline	<b>US8949</b>
1.6L L4 1599cc 98 CID	2010	Mexican Application	<b>US8949</b>
1.6L L4 1600cc 98 CID	2007-2009	Mexican Application	<b>US8949</b>
<b>TIGUAN</b>			
2.0L L4 1984cc 121 CID	2009	S, SE, SEL; Pump only	<b>US9047</b>
2.0L L4 1984cc 121 CID	2009	S, SE, SEL; With back plate housing	<b>US9047-2</b>
2.0L L4 1984cc 121 CID	2009	S, SE, SEL; Electric Water Pump	<b>US11008</b>
2.0L L4 1984cc 121 CID	2010	S, SE, SEL, Wolfsburg Edition; Pump only	<b>US9047</b>
2.0L L4 1984cc 121 CID	2010	S, SE, SEL, Wolfsburg Edition; With back plate housing	<b>US9047-2</b>
2.0L L4 1984cc 121 CID	2010	S, SE, SEL, Wolfsburg Edition; Electric Water Pump	<b>US11008</b>
2.0L L4 1984cc 121 CID	2011-2013	S, SE, SEL; Pump only	<b>US9047</b>
2.0L L4 1984cc 121 CID	2011-2013	S, SE, SEL; With back plate housing	<b>US9047-2</b>
2.0L L4 1984cc 121 CID	2011-2013	S, SE, SEL; Electric Water Pump	<b>US11008</b>
2.0L L4 1984cc 121 CID	2014	R-Line, S, SE, SEL; Electric Water Pump	<b>US11008</b>
2.0L L4 1984cc 121 CID	2014-2015	R-Line, S, SE, SEL; With back plate housing	<b>US9047-2</b>
2.0L L4 1984cc 121 CID	2014-2016	R-Line, S, SE, SEL; Pump only	<b>US9047</b>
2.0L L4 1984cc 121 CID	2014-2016	R-Line, S, SE, SEL; Includes back housing	<b>US9047-2</b>
2.0L L4 1984cc 121 CID	2017	S, SEL, Sport, Wolfsburg Edition; Pump only	<b>US9047</b>
2.0L L4 1984cc 121 CID	2017	S, SEL, Sport, Wolfsburg Edition; Includes back housing	<b>US9047-2</b>
<b>TOUAREG</b>			
3.0L V6 2967cc 181 CID	2009-2011	TDI	<b>US6146</b>
3.0L V6 2967cc 181 CID	2012	TDI Executive, TDI Lux, TDI Sport	<b>US6146</b>
3.0L V6 2967cc 182 CID	2012	Mexican Application	<b>US6146</b>
3.2L V6 3189cc 195 CID	2004	V6; Electric Water Pump	<b>US11004</b>
3.2L V6 3189cc 195 CID	2005-2006	Base	<b>US9471</b>
3.2L V6 3189cc 195 CID	2005-2006	Base; Electric Water Pump	<b>US11004</b>
3.2L V6 3189cc 195 CID	2007	Mexican Application	<b>US9471</b>
3.2L V6 3200cc 195 CID	2004	V6	<b>US9471</b>
3.2L V6 3200cc 195 CID	2004	V6; Electric Water Pump	<b>US11004</b>
3.2L V6 3200cc 195 CID	2005	Base; Electric Water Pump	<b>US11004</b>
3.6L V6 3597cc 219 CID	2007-2009	Base	<b>US6221</b>
3.6L V6 3597cc 219 CID	2007-2009	Base; Electric Water Pump	<b>US11004</b>
3.6L V6 3597cc 219 CID	2010	VR6	<b>US6221</b>
3.6L V6 3597cc 219 CID	2010	VR6; Electric Water Pump	<b>US11004</b>
4.2L V8 4163cc	2007-2009	Base	<b>US6702</b>

Engine	Years	Application Description	USMW
<b>VOLKSWAGEN (cont'd.)</b>			
<b>TOUAREG (cont'd.)</b>			
4.2L V8 4163cc	2007-2009	Base; Electric Water Pump	<b>US11004</b>
4.2L V8 4172cc	2004	V8	<b>US9410</b>
4.2L V8 4172cc	2005-2007	Base	<b>US9410</b>
<b>TRANSPORTER</b>			
2.4L L5 2370cc 144 CID	1993-1994		<b>US9274</b>
2.5L L5 2459cc 150 CID	1992-1993		<b>US9274</b>
<b>VAN</b>			
1.8L L4 1781cc 109 CID	2003	Mexican Application	<b>US9065</b>
<b>VANAGON</b>			
1.9L H4 1915cc	1983-1985	Campmobile, GL, L	<b>US9061</b>
2.1L H4 2109cc	1986	Campmobile, GL, L, Syncro	<b>US9150</b>
2.1L H4 2109cc	1987-1988	Campmobile, GL, Syncro	<b>US9150</b>
2.1L H4 2109cc	1989	Campmobile, Carat, GL, Syncro	<b>US9150</b>
2.1L H4 2109cc	1990-1991	Base, Campmobile, Carat, GL, Syncro	<b>US9150</b>
<b>VENTO</b>			
1.6L L4 1598cc 98 CID	2014-2015	Mexican Application	<b>US8109</b>
1.6L L4 1598cc 98 CID	2014-2016	Mexican Application	<b>US8108</b>
<b>VOLKSWAGEN TRUCK</b>			
<b>TIGUAN</b>			
1.4L L4 1390cc 85 CID	2013-2016	Mexican Application	<b>US8952</b>
<b>VOLVO</b>			
<b>164</b>			
3.0L L6 2980cc	1975		<b>US9077</b>
<b>240</b>			
2.3L L4 2316cc	1990	Base, DL	<b>US9068</b>
2.3L L4 2316cc	1991	Base, SE	<b>US9068</b>
2.3L L4 2316cc	1992	Base, GL	<b>US9068</b>
2.3L L4 2316cc	1993	Base	<b>US9068</b>
<b>242</b>			
2.1L L4 2127cc	1976-1979		<b>US9049</b>
2.1L L4 2127cc	1980	DL	<b>US9049</b>
2.1L L4 2127cc	1981	DL, GL, GLT, Turbo	<b>US9049</b>
2.1L L4 2127cc	1982	DL, GLT	<b>US9049</b>
2.1L L4 2127cc	1983-1984	GLT	<b>US9049</b>
2.3L L4 2316cc	1983-1984	DL	<b>US9049</b>
<b>244</b>			
2.1L L4 2127cc	1976-1979		<b>US9049</b>
2.1L L4 2127cc	1980-1981	DL	<b>US9049</b>
2.1L L4 2127cc	1982	DL, GL, GLT	<b>US9049</b>
2.1L L4 2127cc	1983	GLT	<b>US9049</b>
2.1L L4 2127cc	1984	Base	<b>US9049</b>
2.1L L4 2127cc	1985	Turbo	<b>US9049</b>
2.3L L4 2316cc	1983	DL	<b>US9049</b>
2.3L L4 2316cc	1984	DL, GL	<b>US9049</b>
2.3L L4 2316cc	1985-1989	DL, GL	<b>US9068</b>
2.4L L6 2383cc	1982	DL, GL	<b>US9071</b>
2.4L L6 2383cc	1983	GL	<b>US9071</b>
2.4L L6 2383cc	1984	DL, GL	<b>US9071</b>
<b>245</b>			
2.1L L4 2127cc	1976-1979		<b>US9049</b>
2.1L L4 2127cc	1980	DL	<b>US9049</b>
2.1L L4 2127cc	1981	DL, GLT	<b>US9049</b>
2.1L L4 2127cc	1982	DL, GL, GLT	<b>US9049</b>
2.1L L4 2127cc	1983	GLT	<b>US9049</b>
2.1L L4 2127cc	1984-1985	Base	<b>US9049</b>
2.3L L4 2316cc	1983	DL, GL	<b>US9049</b>
2.3L L4 2316cc	1984	Base	<b>US9049</b>
2.3L L4 2316cc	1985	Base	<b>US9068</b>
2.3L L4 2316cc	1986-1989	DL, GL	<b>US9068</b>
2.4L L6 2383cc	1982	DL	<b>US9071</b>
2.4L L6 2383cc	1983	GL	<b>US9071</b>
2.4L L6 2383cc	1984	Base	<b>US9071</b>
<b>262</b>			
2.7L V6 2673cc	1976		<b>US9147</b>
2.7L V6 2673cc	1978		<b>US9147</b>
2.7L V6 2673cc	1979		<b>US9146</b>
2.8L V6 2849cc	1980	Base	<b>US9146</b>
2.8L V6 2849cc	1981	GL	<b>US9146</b>
<b>264</b>			
2.4L L6 2383cc	1980	GL, GLE	<b>US9071</b>
2.4L L6 2383cc	1981	GL	<b>US9071</b>
2.7L V6 2673cc	1976-1978		<b>US9147</b>
2.7L V6 2673cc	1979		<b>US9146</b>
2.8L V6 2849cc	1980	GL, GLE	<b>US9146</b>
2.8L V6 2849cc	1981-1982	GLE	<b>US9146</b>
<b>265</b>			
2.4L L6 2383cc	1980	GLE	<b>US9071</b>

Engine	Years	Application Description	USMW	Engine	Years	Application Description	USMW
<b>VOLVO (cont'd.)</b>				<b>VOLVO (cont'd.)</b>			
<b>265 (cont'd.)</b>				<b>S70</b>			
2.7L V6 2673cc	1976-1978		US9147	2.3L L5 2319cc	1998-2000	T5	US9339
2.7L V6 2673cc	1979		US9146	2.4L L5 2435cc	1998	Base, GLT	US9339
2.8L V6 2849cc	1980-1981	GLE	US9146	2.4L L5 2435cc	1999	AWD, Base, GLT	US9339
<b>740</b>				2.4L L5 2435cc	2000	AWD, Base, GLT, GLT SE	US9339
2.3L L4 2316cc	1985-1988	GLE	US9068	<b>S80</b>			
2.3L L4 2316cc	1989-1990	Base, GL, GLE	US9068	2.5L L5 2521cc	2004-2006	2.5T, 2.5T AWD	US9339
2.3L L4 2316cc	1991-1992	Base, T	US9068	2.8L L6 2783cc 170 CID	2004-2006	Mexican Application	US9339
2.4L L6 2377cc	1986	GLE	US9071	2.8L L6 2798cc	1999-2001	T6	US9382
<b>745</b>				2.9L L6 2917cc	1999-2001	2.9	US9382
2.3L L4 2316cc	1985	GLE	US9068	2.9L L6 2917cc	2002	2.9, T6	US9382
2.4L L6 2383cc	1985	GLE	US9071	2.9L L6 2917cc	2003-2004	2.9, T6	US9456
<b>760</b>				2.9L L6 2917cc	2005	T6, T6 Premier	US9456
2.3L L4 2316cc	1984	GLE	US9049	3.0L L6 2953cc	2011-2015	T6	US8134
2.3L L4 2316cc	1985	Base, GLE	US9068	3.2L L6 3192cc	2011-2014	3.2	US8134
2.3L L4 2316cc	1986-1988	GLE	US9068	4.4L V8 4414cc 269 CID	2007-2010	V8	US6276
2.3L L4 2316cc	1989-1990	Base	US9068	<b>S90</b>			
2.4L L6 2377cc	1985	GLE	US9071	2.9L L6 2917cc	1997-1998	Base	US9340
2.4L L6 2383cc	1983-1984	GLE	US9071	<b>V40</b>			
<b>780</b>				1.9L L4 1948cc	2000-2003	Base	US9339
2.3L L4 2316cc	1989-1991	Base	US9068	1.9L L4 1948cc	2003	Base; (B4204T4)	US9339
<b>850</b>				1.9L L4 1948cc	2004	Base, LSE	US9339
2.3L L5 2319cc	1994	Turbo; From Engine 131035	US9339	1.9L L4 1948cc 119 CID	1999	Mexican Application	US9339
2.3L L5 2319cc	1994	Turbo; To Engine 131034	US9339	<b>V50</b>			
2.3L L5 2319cc	1995	T-5R, Turbo; From Engine 131035	US9339	2.4L L5 2435cc	2005	i	US9339
2.3L L5 2319cc	1995	T-5R, Turbo; To Engine 131034	US9339	2.4L L5 2435cc	2006-2010	2.4i	US9339
2.3L L5 2319cc	1996	R, Turbo; From Engine 131035	US9339	2.5L L5 2521cc	2005-2009	T5	US9339
2.3L L5 2319cc	1996	R, Turbo; To Engine 131034	US9339	2.5L L5 2521cc	2010	T5 R-Design	US9339
2.3L L5 2319cc	1997	R, T-5; From Engine 131035	US9339	2.5L L5 2521cc	2011	T5, T5 R-Design	US9339
2.3L L5 2319cc	1997	R, T-5; To Engine 131034	US9339	<b>V60</b>			
2.4L L5 2435cc	1993	GLT; From Engine 131035	US9339	2.5L L5 2521cc	2015	T5, T5 Platinum, T5 Premier, T5 Premier Plus	US9339
2.4L L5 2435cc	1993	GLT; To Engine 131034	US9339	2.5L L5 2521cc	2016	T5 Platinum, T5 Premier	US9339
2.4L L5 2435cc	1994-1997	Base, GLT; From Engine 131035	US9339	3.0L L6 2953cc	2015-2016	T6 Polestar, T6 R-Design, T6 R-Design Platinum	US8134
2.4L L5 2435cc	1994-1997	Base, GLT; To Engine 131034	US9339	<b>V60 CROSS COUNTRY</b>			
<b>940</b>				2.5L L5 2521cc	2015	T5	US9339
2.3L L4 2316cc	1991	GLE, SE, T	US9068	2.5L L5 2521cc	2016	T5, T5 Platinum	US9339
2.3L L4 2316cc	1992	GL, T	US9068	<b>V70</b>			
2.3L L4 2316cc	1993-1995	Base, T	US9068	2.3L L5 2319cc	1998	R, T5	US9339
<b>960</b>				2.3L L5 2319cc	1999-2000	R AWD, T5	US9339
2.9L L6 2922cc	1992-1994	Base	US9339	2.3L L5 2319cc	2001-2004	T5	US9339
2.9L L6 2922cc	1995-1997	Base	US9340	2.4L L5 2435cc	1998-1999	AWD, Base, GLT, X/C AWD	US9339
<b>C30</b>				2.4L L5 2435cc	2000	Base, GLT, GLT SE, X/C AWD, X/C AWD SE	US9339
2.4L L5 2400cc 146 CID	2008-2009	Mexican Application	US9339	2.4L L5 2435cc	2001	2.4T, Base, X/C	US9339
2.5L L5 2521cc	2008-2013	T5, T5 R-Design	US9339	2.4L L5 2435cc	2002	2.4T, AWD, Base, X/C	US9339
<b>C70</b>				2.4L L5 2435cc	2003	2.4T, Base	US9339
2.3L L5 2319cc	1998-2004	Base	US9339	2.4L L5 2435cc	2004	2.4	US9339
2.4L L5 2435cc	1998-2004	Base	US9339	2.4L L5 2435cc	2005	2.4, T5	US9339
2.5L L5 2521cc	2006-2013	T5	US9339	2.4L L5 2435cc	2006-2007	2.4	US9339
<b>S40</b>				2.5L L5 2521cc	2003	AWD	US9339
1.9L L4 1948cc	2000-2003	Base	US9339	2.5L L5 2521cc	2004	R	US9339
1.9L L4 1948cc	2004	Base, LSE	US9339	2.5L L5 2521cc	2005-2007	2.5T, R	US9339
1.9L L4 1948cc 119 CID	1999	Mexican Application	US9339	<b>V90</b>			
2.4L L5 2435cc	2004-2005	i	US9339	2.9L L6 2917cc	1997-1998	Base	US9340
2.4L L5 2435cc	2006-2010	2.4i	US9339	<b>XC60</b>			
2.5L L5 2521cc	2004-2009	T5	US9339	2.5L L5 2521cc	2015	T5	US9339
2.5L L5 2521cc	2010	T5 R-Design	US9339	2.5L L5 2521cc	2016	T5, T5 Platinum, T5 Premier	US9339
2.5L L5 2521cc	2011	T5, T5 R-Design	US9339	3.0L L6 2953cc	2011-2014	T6, T6 R-Design	US8134
<b>S60</b>				3.0L L6 2953cc	2015	T6, T6 Ocean Race, T6 R-Design	US8134
2.3L L5 2319cc	2001-2004	T5	US9339	3.0L L6 2953cc	2016	T6, T6 Platinum, T6 Premier, T6 R-Design, T6 R-Design Platinum	US8134
2.4L L5 2435cc	2001	2.4T, Base	US9339	3.0L L6 2953cc 180 CID	2013	T6 R-Design	US8134
2.4L L5 2435cc	2002	2.4T, AWD, Base	US9339	3.2L L6 3192cc	2011	3.2, 3.2 R-Design	US8134
2.4L L5 2435cc	2003	2.4T, Base	US9339	3.2L L6 3192cc	2012-2015	3.2	US8134
2.4L L5 2435cc	2004	2.4	US9339	<b>XC70</b>			
2.4L L5 2435cc	2005	2.4, T5	US9339	2.5L L5 2521cc	2003	X/C	US9339
2.4L L5 2435cc	2006-2009	T5	US9339	2.5L L5 2521cc	2004-2005	Base	US9339
2.5L L5 2521cc	2003	AWD	US9339	2.5L L5 2521cc	2006	Base, Ocean Race	US9339
2.5L L5 2521cc	2004-2005	2.5T, 2.5T AWD, R	US9339	2.5L L5 2521cc	2007	Base	US9339
2.5L L5 2521cc	2006-2007	2.5T, R	US9339	2.5L L5 2521cc	2016	T5, T5 Platinum, T5 Premier	US9339
2.5L L5 2521cc	2008-2009	2.5T	US9339	3.0L L6 2953cc	2011-2015	T6	US8134
2.5L L5 2521cc	2012-2014	T5	US9339	3.2L L6 3192cc	2011-2015	3.2	US8134
2.5L L5 2521cc	2015	T5, T5 Platinum, T5 Premier, T5 Premier Plus	US9339	<b>XC90</b>			
2.5L L5 2521cc	2016	T5, T5 Inscription Platinum, T5 Inscription Premier, T5 Premier	US9339	2.5L L5 2521cc	2003	Base	US9339
3.0L L6 2953cc	2011-2012	T6	US8134	2.5L L5 2521cc	2004-2006	2.5T	US9339
3.0L L6 2953cc	2013-2014	T6, T6 R-Design	US8134	2.5L L5 2521cc 154 CID	2007	Mexican Application	US9339
3.0L L6 2953cc	2015-2016	T6 Polestar, T6 R-Design, T6 R-Design Platinum	US8134	2.8L L6 2783cc 170 CID	2003-2006	Mexican Application	US9339
3.0L L6 2953cc 180 CID	2013	T6 R-Design	US8134	2.9L L6 2917cc	2003-2005	T6	US9456
<b>S60 CROSS COUNTRY</b>				4.4L V8 4414cc 269 CID	2005	V8	US6276
2.5L L5 2521cc	2016	T5 Platinum	US9339				

WATER PUMPS



# WATER PUMP APPLICATION GUIDE



Engine	Years	Application Description	USMw	Engine	Years	Application Description	USMw
<b>VOLVO (cont'd.)</b>							
<b>XC90 (cont'd.)</b>							
4.4L V8 4414cc 269 CID	2006	V8, V8 Ocean Race	US6276				
4.4L V8 4414cc 269 CID	2007-2008	V8, V8 Sport	US6276				
4.4L V8 4414cc 269 CID	2009-2011	V8	US6276				



USMW	Years	Application	Engine	USMW	Years	Application	Engine
<b>US43N</b>	1947-1951	CHEVROLET SEDAN DELIVERY	3.8L L6 3852cc 235 CID	<b>US64-T</b>	1999-2006	GMC SIERRA 1500	5.3L V8 5328cc 325 CID
	1950-1952	CHEVROLET STYLELINE DELUXE	3.8L L6 3852cc 235 CID		2000-2006	CHEVROLET SUBURBAN 1500	5.3L V8 5328cc 325 CID
	1950-1952	CHEVROLET STYLELINE SPECIAL	3.8L L6 3852cc 235 CID		2000-2006	CHEVROLET SUBURBAN 2500	6.0L V8 5967cc 364 CID
	1953-1954	CHEVROLET SEDAN DELIVERY	3.8L L6 3852cc 235 CID		2000-2006	CHEVROLET TAHOE	4.8L V8 294 CID
	1958	CHEVROLET YEOMAN	3.8L L6 3852cc 235 CID	2000-2006	CHEVROLET TAHOE	5.3L V8 5328cc 325 CID	
<b>US52</b>	1958-1962	JEEP TRUCK	3.7L L6 3704cc 226 CID	2000-2006	GMC YUKON	4.8L V8 294 CID	
	1958-1966	JEEP TRUCK	2.2L L4 2197cc 134 CID	2000-2006	GMC YUKON	5.3L V8 5328cc 325 CID	
	1959-1971	JEEP CJ5	2.2L L4 2197cc 134 CID	2000-2006	GMC YUKON XL 1500	5.3L V8 5328cc 325 CID	
	1959-1971	JEEP CJ6	2.2L L4 2197cc 134 CID	2000-2006	GMC YUKON XL 2500	6.0L V8 5967cc 364 CID	
<b>US61</b>	2003-2004	FORD F-250 SUPER DUTY	6.0L V8 363 CID	2001-2003	CHEVROLET SILVERADO 1500 HD	6.0L V8 5967cc 364 CID	
	2003-2004	FORD F-350 SUPER DUTY	6.0L V8 363 CID	2001-2003	GMC SIERRA 1500 HD	6.0L V8 5967cc 364 CID	
	2003-2004	FORD F-450 SUPER DUTY	6L V8 363 CID	2001-2006	CHEVROLET SILVERADO 2500 HD	6.0L V8 5967cc 364 CID	
	2003-2004	FORD F-550 SUPER DUTY	6L V8 363 CID	2001-2006	CHEVROLET SILVERADO 3500	6.0L V8 5967cc 364 CID	
	2003-2005	FORD EXCURSION	6.0L V8 363 CID	2001-2006	GMC SIERRA 1500	6.0L V8 5967cc 364 CID	
<b>US63</b>	2001-2005	CHEVROLET SILVERADO 2500 HD	6.6L V8 6599cc 403 CID	2001-2006	GMC SIERRA 2500 HD	6.0L V8 5967cc 364 CID	
	2001-2005	CHEVROLET SILVERADO 3500	6.6L V8 6599cc 403 CID	2001-2006	GMC SIERRA 3500	6.0L V8 5967cc 364 CID	
	2001-2005	GMC SIERRA 2500 HD	6.6L V8 6599cc 403 CID	2001-2006	GMC YUKON	6.0L V8 5967cc 364 CID	
	2001-2005	GMC SIERRA 3500	6.6L V8 6599cc 403 CID	2001-2006	GMC YUKON XL 1500	6.0L V8 5967cc 364 CID	
<b>US64</b>	1999-2000	CHEVROLET SILVERADO 2500	5.3L V8 5328cc 325 CID	2002-2005	CADILLAC ESCALADE	5.3L V8 5328cc 325 CID	
	1999-2000	GMC SIERRA 2500	5.3L V8 5328cc 325 CID	2002-2006	CADILLAC ESCALADE	6.0L V8 5967cc 364 CID	
	1999-2004	CHEVROLET SILVERADO 2500	6.0L V8 5967cc 364 CID	2002-2006	CADILLAC ESCALADE EXT	6.0L V8 5967cc 364 CID	
	1999-2004	GMC SIERRA 2500	6.0L V8 5967cc 364 CID	2002-2006	CHEVROLET AVALANCHE 1500	5.3L V8 5328cc 325 CID	
1999-2006	CHEVROLET SILVERADO 1500	4.8L V8 294 CID	2003-2004	CHEVROLET SSR	5.3L V8 5328cc 325 CID		
1999-2006	CHEVROLET SILVERADO 1500	5.3L V8 5328cc 325 CID	2003-2005	CHEVROLET EXPRESS 2500	5.3L V8 5328cc 325 CID		
1999-2006	GMC SIERRA 1500	4.8L V8 294 CID	2003-2005	GMC SAVANA 2500	5.3L V8 5328cc 325 CID		
1999-2006	GMC SIERRA 1500	5.3L V8 5328cc 325 CID	2003-2006	CADILLAC ESCALADE ESV	6.0L V8 5967cc 364 CID		
2000-2006	CHEVROLET SUBURBAN 1500	5.3L V8 5328cc 325 CID	2003-2006	CHEVROLET EXPRESS 1500	5.3L V8 5328cc 325 CID		
2000-2006	CHEVROLET SUBURBAN 2500	6.0L V8 5967cc 364 CID	2003-2006	CHEVROLET EXPRESS 2500	4.8L V8 294 CID		
2000-2006	CHEVROLET TAHOE	4.8L V8 294 CID	2003-2006	CHEVROLET EXPRESS 2500	6.0L V8 5967cc 364 CID		
2000-2006	CHEVROLET TAHOE	5.3L V8 5328cc 325 CID	2003-2006	CHEVROLET EXPRESS 3500	6.0L V8 5967cc 364 CID		
2000-2006	GMC YUKON	4.8L V8 294 CID	2003-2006	CHEVROLET SILVERADO 1500	6.0L V8 5967cc 364 CID		
2000-2006	GMC YUKON	5.3L V8 5328cc 325 CID	2003-2006	CHEVROLET TRAILBLAZER EXT	5.3L V8 5328cc 325 CID		
2000-2006	GMC YUKON XL 1500	5.3L V8 5328cc 325 CID	2003-2006	GMC ENVOY XL	5.3L V8 5328cc 325 CID		
2000-2006	GMC YUKON XL 2500	6.0L V8 5967cc 364 CID	2003-2006	GMC SAVANA 1500	5.3L V8 5328cc 325 CID		
2001-2003	CHEVROLET SILVERADO 1500 HD	6.0L V8 5967cc 364 CID	2003-2006	GMC SAVANA 2500	4.8L V8 294 CID		
2001-2003	GMC SIERRA 1500 HD	6.0L V8 5967cc 364 CID	2003-2006	GMC SAVANA 2500	6.0L V8 5967cc 364 CID		
2001-2006	CHEVROLET SILVERADO 2500 HD	6.0L V8 5967cc 364 CID	2003-2006	GMC SAVANA 3500	6.0L V8 5967cc 364 CID		
2001-2006	CHEVROLET SILVERADO 3500	6.0L V8 5967cc 364 CID	2003-2006	HUMMER H2	6.0L V8 5967cc 364 CID		
2001-2006	GMC SIERRA 1500	6.0L V8 5967cc 364 CID	2003-2006	ISUZU ASCENDER	5.3L V8 5328cc 325 CID		
2001-2006	GMC SIERRA 2500 HD	6.0L V8 5967cc 364 CID	2004-2005	GMC ENVOY XUV	5.3L V8 5328cc 325 CID		
2001-2006	GMC SIERRA 3500	6.0L V8 5967cc 364 CID	2004-2006	BUICK RAINIER	5.3L V8 5328cc 325 CID		
2001-2006	GMC YUKON	6.0L V8 5967cc 364 CID	2004-2006	GMC SAVANA 3500	4.8L V8 294 CID		
2001-2006	GMC YUKON XL 1500	6.0L V8 5967cc 364 CID	2005-2006	CHEVROLET EXPRESS 3500	4.8L V8 294 CID		
2002	CHEVROLET SILVERADO 2500	5.7L V8 5737cc 350 CID	2005-2006	CHEVROLET SILVERADO 1500 HD	6.0L V8 5967cc 364 CID		
2002-2005	CADILLAC ESCALADE	5.3L V8 5328cc 325 CID	2005-2006	CHEVROLET SSR	6.0L V8 5967cc 364 CID		
2002-2006	CADILLAC ESCALADE	6.0L V8 5967cc 364 CID	2005-2006	GMC ENVOY	5.3L V8 5328cc 325 CID		
2002-2006	CADILLAC ESCALADE EXT	6.0L V8 5967cc 364 CID	2005-2006	GMC SIERRA 1500 HD	6.0L V8 5967cc 364 CID		
2002-2006	CHEVROLET AVALANCHE 1500	5.3L V8 5328cc 325 CID	2005-2006	SAAB 9-7X	5.3L V8 5328cc 325 CID		
2003-2004	CHEVROLET SSR	5.3L V8 5328cc 325 CID	2006	CHEVROLET SUBURBAN 1500	6.0L V8 5967cc 364 CID		
2003-2005	CHEVROLET EXPRESS 2500	5.3L V8 5328cc 325 CID	2006	CHEVROLET TRAILBLAZER	5.3L V8 5328cc 325 CID		
2003-2005	GMC SAVANA 2500	5.3L V8 5328cc 325 CID	2006	CHEVROLET TRAILBLAZER	6.0L V8 5967cc 364 CID		
2003-2006	CADILLAC ESCALADE ESV	6.0L V8 5967cc 364 CID	<b>US65</b>	2005-2006	PONTIAC GTO	6.0L V8 5967cc 364 CID	
2003-2006	CHEVROLET EXPRESS 1500	5.3L V8 5328cc 325 CID	<b>US65N</b>	2004-2005	CADILLAC CTS	5.7L V8 346 CID	
2003-2006	CHEVROLET EXPRESS 2500	4.8L V8 294 CID	2005	CHEVROLET CORVETTE	6.0L V8 364 CID		
2003-2006	CHEVROLET EXPRESS 2500	6.0L V8 5967cc 364 CID	2006-2007	CADILLAC CTS	6.0L V8 5967cc 364 CID		
2003-2006	CHEVROLET EXPRESS 3500	6.0L V8 5967cc 364 CID	2006-2007	CHEVROLET CORVETTE	6.0L V8 5967cc 364 CID		
2003-2006	CHEVROLET SILVERADO 1500	6.0L V8 5967cc 364 CID	2006-2008	CHEVROLET CORVETTE	7.0L V8 7011cc 427 CID		
2003-2006	CHEVROLET TRAILBLAZER EXT	5.3L V8 5328cc 325 CID	2008	CHEVROLET CORVETTE	6.2L V8 6162cc 376 CID		
2003-2006	GMC ENVOY XL	5.3L V8 5328cc 325 CID	2008-2009	PONTIAC G8	6.0L V8 5967cc 364 CID		
2003-2006	GMC SAVANA 1500	5.3L V8 5328cc 325 CID	<b>US65N-T</b>	2004-2005	CADILLAC CTS	5.7L V8 346 CID	
2003-2006	GMC SAVANA 2500	4.8L V8 294 CID	2005	CHEVROLET CORVETTE	6.0L V8 364 CID		
2003-2006	GMC SAVANA 2500	6.0L V8 5967cc 364 CID	2006-2007	CADILLAC CTS	6.0L V8 5967cc 364 CID		
2003-2006	GMC SAVANA 3500	6.0L V8 5967cc 364 CID	2006-2007	CHEVROLET CORVETTE	6.0L V8 5967cc 364 CID		
2003-2006	HUMMER H2	6.0L V8 5967cc 364 CID	2006-2008	CHEVROLET CORVETTE	7.0L V8 7011cc 427 CID		
2003-2006	ISUZU ASCENDER	5.3L V8 5328cc 325 CID	2008	CHEVROLET CORVETTE	6.2L V8 6162cc 376 CID		
2004-2005	GMC ENVOY XUV	5.3L V8 5328cc 325 CID	2008-2009	PONTIAC G8	6.0L V8 5967cc 364 CID		
2004-2006	BUICK RAINIER	5.3L V8 5328cc 325 CID	<b>US65-T</b>	2005-2006	PONTIAC GTO	6.0L V8 5967cc 364 CID	
2004-2006	GMC SAVANA 3500	4.8L V8 294 CID	<b>US66</b>	1994	INTERNATIONAL 3700	7.3L V8 444 CID	
2004-2009	CHEVROLET SILVERADO 2500	5.3L V8 5300cc 323 CID	1994	INTERNATIONAL 4600LP	7.3L V8 444 CID		
2005-2006	CHEVROLET EXPRESS 3500	4.8L V8 294 CID	1994-1999	INTERNATIONAL 3600	7.3L V8 444 CID		
2005-2006	CHEVROLET SILVERADO 1500 HD	6.0L V8 5967cc 364 CID	1994-2002	INTERNATIONAL 4700LP	7.3L V8 444 CID		
2005-2006	CHEVROLET SONORA	5.3L V8 5300cc 323 CID	1994-2004	INTERNATIONAL 3800	7.3L V8 444 CID		
2005-2006	CHEVROLET SSR	6.0L V8 5967cc 364 CID	1995-2002	INTERNATIONAL 4700LPX	7.3L V8 444 CID		
2005-2006	GMC ENVOY	5.3L V8 5328cc 325 CID	1996-2002	INTERNATIONAL 3400	7.3L V8 444 CID		
2005-2006	GMC SIERRA 1500 HD	6.0L V8 5967cc 364 CID	1996-2002	INTERNATIONAL GENESIS RE	7.3L V8 444 CID		
2005-2006	SAAB 9-7X	5.3L V8 5328cc 325 CID	1997-2000	INTERNATIONAL 3000	7.3L V8 444 CID		
2006	CHEVROLET SUBURBAN 1500	5.3L V8 5300cc 323 CID	2000-2002	INTERNATIONAL 3000IC	7.3L V8 444 CID		
2006	CHEVROLET SUBURBAN 1500	6.0L V8 5967cc 364 CID	2000-2003	FORD F650	7.3L V8 444 CID		
2006	CHEVROLET TRAILBLAZER	5.3L V8 5328cc 325 CID	2000-2003	FORD F750	7.3L V8 444 CID		
2006	CHEVROLET TRAILBLAZER	6.0L V8 5967cc 364 CID	2004-2005	INTERNATIONAL 1652SC	7.3L V8 444 CID		
2006-2009	CHEVROLET SILVERADO 2500	4.8L V8 4800cc 293 CID	<b>US67</b>	2004-2005	FORD E-350 CLUB WAGON	6.0L V8 363 CID	
2007	CHEVROLET SILVERADO 3500	5.7L V8 5737cc 350 CID	2004-2007	FORD F-250 SUPER DUTY	6.0L V8 363 CID		
<b>US64-T</b>	1999-2000	CHEVROLET SILVERADO 2500	5.3L V8 5328cc 325 CID	2004-2007	FORD F-350 SUPER DUTY	6.0L V8 363 CID	
	1999-2000	GMC SIERRA 2500	5.3L V8 5328cc 325 CID	2004-2007	FORD F-450 SUPER DUTY	6L V8 363 CID	
	1999-2004	CHEVROLET SILVERADO 2500	6.0L V8 5967cc 364 CID	2004-2007	FORD F-550 SUPER DUTY	6L V8 363 CID	
	1999-2004	GMC SIERRA 2500	6.0L V8 5967cc 364 CID	2004-2010	FORD E-350 SUPER DUTY	6.0L V8 363 CID	
1999-2006	CHEVROLET SILVERADO 1500	4.8L V8 294 CID	2004-2010	FORD E-450 SUPER DUTY	6L V8 363 CID		
1999-2006	CHEVROLET SILVERADO 1500	5.3L V8 5328cc 325 CID	<b>US72</b>	2006	CHEVROLET SILVERADO 3500	6.6L V8 6599cc 403 CID	
1999-2006	GMC SIERRA 1500	4.8L V8 294 CID	2006	GMC SIERRA 3500	6.6L V8 6599cc 403 CID		

WATER PUMPS

USMW	Years	Application	Engine	USMW	Years	Application	Engine	
<b>US72</b>	2006-2016	<b>CHEVROLET EXPRESS 2500</b>	6.6L V8 6599cc 403 CID	<b>US488</b>	1959-1960	<b>MERCURY MONTEREY</b>	5.1L V8 5114cc 312 CID	
	2006-2016	<b>CHEVROLET EXPRESS 3500</b>	6.6L V8 6599cc 403 CID		1959-1962	<b>FORD GALAXIE</b>	4.8L V8 4786cc 292 CID	
	2006-2016	<b>CHEVROLET SILVERADO 2500 HD</b>	6.6L V8 6599cc 403 CID	1960	<b>MERCURY MONTCLAIR</b>	5.1L V8 5114cc 312 CID		
	2006-2016	<b>GMC SAVANA 2500</b>	6.6L V8 6599cc 403 CID	1961	<b>MERCURY METEOR</b>	4.8L V8 4786cc 292 CID		
	2006-2016	<b>GMC SAVANA 3500</b>	6.6L V8 6599cc 403 CID	1961-1962	<b>MERCURY MONTEREY</b>	4.8L V8 4786cc 292 CID		
	2006-2016	<b>GMC SIERRA 2500 HD</b>	6.6L V8 6599cc 403 CID	<b>US670</b>	1963	<b>CADILLAC COMMERCIAL CHASSIS</b>	6.4L V8 6392cc 390 CID	
	2007	<b>CHEVROLET SILVERADO 2500 HD CLASSIC</b>	6.6L V8 6599cc 403 CID		1964-1965	<b>CADILLAC COMMERCIAL CHASSIS</b>	7.0L V8 7031cc 429 CID	
	2007	<b>CHEVROLET SILVERADO 3500 CLASSIC</b>	6.6L V8 6599cc 403 CID	<b>US713</b>	1955-1956	<b>PLYMOUTH BELVEDERE</b>	3.8L L6 3770cc 230 CID	
	2007	<b>GMC SIERRA 2500 HD CLASSIC</b>	6.6L V8 6599cc 403 CID		1955-1956	<b>PLYMOUTH PLAZA</b>	3.8L L6 3770cc 230 CID	
	2007	<b>GMC SIERRA 3500 CLASSIC</b>	6.6L V8 6599cc 403 CID		1955-1956	<b>PLYMOUTH SAVOY</b>	3.8L L6 3770cc 230 CID	
	2007-2016	<b>CHEVROLET SILVERADO 3500 HD</b>	6.6L V8 6599cc 403 CID		1958-1959	<b>DODGE D100 PICKUP</b>	3.8L L6 3770cc 230 CID	
	2007-2016	<b>GMC SIERRA 3500 HD</b>	6.6L V8 6599cc 403 CID		1958-1959	<b>DODGE D200 PICKUP</b>	3.8L L6 3770cc 230 CID	
	2009-2016	<b>CHEVROLET EXPRESS 4500</b>	6.6L V8 6599cc 403 CID		1958-1959	<b>DODGE D300 PICKUP</b>	3.8L L6 3770cc 230 CID	
	2009-2016	<b>GMC SAVANA 4500</b>	6.6L V8 6599cc 403 CID		1958-1959	<b>DODGE W100 PICKUP</b>	3.8L L6 3770cc 230 CID	
	<b>US73</b>	2000-2002	<b>CHEVROLET T6500</b>		7.8L L6 475 CID	1958-1959	<b>DODGE W200 PICKUP</b>	3.8L L6 3770cc 230 CID
		2000-2002	<b>CHEVROLET T7500</b>		7.8L L6 475 CID	1958-1959	<b>DODGE W300 PICKUP</b>	3.8L L6 3770cc 230 CID
		2000-2002	<b>GMC T6500</b>		7.8L L6 475 CID	1958-1960	<b>DODGE WM300 POWER WAGON</b>	3.8L L6 3770cc 230 CID
		2000-2002	<b>GMC T7500</b>		7.8L L6 475 CID	1961-1962	<b>MERCURY COLONY PARK</b>	5.8L V8 5769cc 352 CID
		2000-2002	<b>ISUZU FRR</b>		7.8L L6 475 CID	1961-1962	<b>MERCURY COMMUTER</b>	5.8L V8 5769cc 352 CID
		<b>US76</b>	2008-2010	<b>FORD F-250 SUPER DUTY</b>	6.4L V8 391 CID	1961-1962	<b>MERCURY METEOR</b>	5.8L V8 5769cc 352 CID
2008-2010			<b>FORD F-350 SUPER DUTY</b>	6.4L V8 391 CID	1961-1963	<b>MERCURY MONTEREY</b>	6.4L V8 6391cc 390 CID	
2008-2010			<b>FORD F-450 SUPER DUTY</b>	6.4L V8 391 CID	1961-1964	<b>MERCURY METEOR</b>	5.8L V8 5769cc 352 CID	
2008-2010	<b>FORD F-550 SUPER DUTY</b>		6.4L V8 391 CID	1961-1964	<b>FORD COUNTRY SEDAN</b>	6.4L V8 6391cc 390 CID		
<b>US77</b>	2011-2016	<b>FORD F-250 SUPER DUTY</b>	6.7L V8 6651cc 406 CID	1961-1964	<b>FORD COUNTRY SEDAN</b>	5.8L V8 5769cc 352 CID		
	2011-2016	<b>FORD F-250 SUPER DUTY</b>	6.7L V8 6700cc 409 CID	1961-1964	<b>FORD COUNTRY SQUIRE</b>	5.8L V8 5769cc 352 CID		
	2011-2016	<b>FORD F-350 SUPER DUTY</b>	6.7L V8 6651cc 406 CID	1961-1964	<b>FORD COUNTRY SQUIRE</b>	6.4L V8 6391cc 390 CID		
	2011-2016	<b>FORD F-450 SUPER DUTY</b>	6.7L V8 6651cc 406 CID	1961-1964	<b>FORD FAIRLANE</b>	5.8L V8 352 CID		
	2011-2016	<b>FORD F-550 SUPER DUTY</b>	6.7L V8 6651cc 406 CID	1961-1964	<b>FORD FAIRLANE</b>	5.8L V8 5769cc 352 CID		
	2013-2014	<b>FORD F-450</b>	6.7L V8 6700cc 409 CID	1961-1964	<b>FORD FAIRLANE</b>	6.4L V8 390 CID		
	2013-2014	<b>FORD F-550</b>	6.7L V8 6700cc 409 CID	1961-1964	<b>FORD FAIRLANE</b>	6.4L V8 6391cc 390 CID		
<b>US78</b>	2011-2016	<b>FORD F-250 SUPER DUTY</b>	6.7L V8 6651cc 406 CID	1961-1964	<b>FORD GALAXIE</b>	5.8L V8 5769cc 352 CID		
	2011-2016	<b>FORD F-350 SUPER DUTY</b>	6.7L V8 6651cc 406 CID	1961-1964	<b>FORD GALAXIE</b>	6.4L V8 6391cc 390 CID		
<b>US79</b>	2009	<b>PONTIAC G8</b>	6.2L V8 6162cc 376 CID	1961-1964	<b>FORD RANCH WAGON</b>	5.8L V8 5769cc 352 CID		
	2009-2013	<b>CHEVROLET CORVETTE</b>	6.2L V8 6162cc 376 CID	1961-1964	<b>FORD RANCH WAGON</b>	6.4L V8 6391cc 390 CID		
	2009-2013	<b>CHEVROLET CORVETTE</b>	7.0L V8 7011cc 427 CID	1961-1964	<b>FORD THUNDERBIRD</b>	6.4L V8 6391cc 390 CID		
	2009-2015	<b>CADILLAC CTS</b>	6.2L V8 6162cc 376 CID	1961-1964	<b>MERCURY COLONY PARK</b>	6.4L V8 6391cc 390 CID		
	2011-2017	<b>CHEVROLET CAMARO</b>	6.0L V8 5967cc 364 CID	1961-1964	<b>MERCURY COMMUTER</b>	6.4L V8 6391cc 390 CID		
	2012-2015	<b>CHEVROLET CAPARO</b>	6.2L V8 6162cc 376 CID	1961-1964	<b>MERCURY MONTEREY</b>	6.4L V8 6391cc 390 CID		
	2014-2017	<b>CHEVROLET SS</b>	6.2L V8 6162cc 376 CID	1962-1963	<b>FORD COUNTRY SEDAN</b>	6.6L V8 6654cc 406 CID		
	<b>US85</b>	2004-2007	<b>FORD F650</b>	6L V8 365 CID	1962-1963	<b>FORD COUNTRY SQUIRE</b>	6.6L V8 6654cc 406 CID	
2004-2007		<b>FORD F750</b>	6L V8 365 CID	1962-1963	<b>FORD GALAXIE</b>	6.6L V8 6654cc 406 CID		
<b>US99</b>	2013-2018	<b>RAM 2500</b>	6.7L L6 408 CID	1962-1963	<b>FORD RANCH WAGON</b>	6.6L V8 6654cc 406 CID		
	2013-2018	<b>RAM 3500</b>	6.7L L6 408 CID	1962-1963	<b>MERCURY COLONY PARK</b>	6.6L V8 6654cc 406 CID		
	2013-2018	<b>RAM 4500</b>	6.7L L6 408 CID	1962-1963	<b>MERCURY COMMUTER</b>	6.6L V8 6654cc 406 CID		
	2013-2018	<b>RAM 5500</b>	6.7L L6 408 CID	1962-1963	<b>MERCURY MONTEREY</b>	6.4L V8 390 CID		
<b>US127</b>	1958	<b>CHEVROLET DEL RAY</b>	5.7L V8 5704cc 348 CID	1962-1964	<b>MERCURY MONTEREY</b>	6.6L V8 6654cc 406 CID		
	1958-1961	<b>CHEVROLET BEL AIR</b>	5.7L V8 5704cc 348 CID	1962-1964	<b>FORD GALAXIE 500</b>	5.8L V8 352 CID		
	1958-1961	<b>CHEVROLET BISCAVNE</b>	5.7L V8 5704cc 348 CID	1963	<b>FORD FORD 300</b>	6.4L V8 6391cc 390 CID		
	1959-1961	<b>CHEVROLET IMPALA</b>	5.7L V8 5704cc 348 CID	1963	<b>FORD FORD 300</b>	6.4L V8 6391cc 390 CID		
	1961-1964	<b>CHEVROLET BEL AIR</b>	6.7L V8 6704cc 409 CID	1963	<b>FORD FORD 300</b>	6.6L V8 6654cc 406 CID		
	1961-1964	<b>CHEVROLET BISCAVNE</b>	6.7L V8 6704cc 409 CID	1963	<b>FORD FORD 300</b>	7.0L V8 6997cc 427 CID		
	1961-1964	<b>CHEVROLET IMPALA</b>	6.7L V8 6704cc 409 CID	1963	<b>FORD THUNDERBIRD</b>	6.6L V8 6654cc 406 CID		
	<b>US310</b>	2017	<b>CHEVROLET SILVERADO 2500 HD</b>	6.6L V8 6599cc 403 CID	1963	<b>MERCURY COUNTRY CRUISER</b>	6.4L V8 6391cc 390 CID	
2017		<b>CHEVROLET SILVERADO 3500 HD</b>	6.6L V8 6599cc 403 CID	1963	<b>MERCURY MARAUDER</b>	6.6L V8 6654cc 406 CID		
2017		<b>GMC SIERRA 2500 HD</b>	6.6L V8 6599cc 403 CID	1963-1964	<b>FORD COUNTRY SEDAN</b>	7.0L V8 6997cc 427 CID		
2017		<b>GMC SIERRA 3500 HD</b>	6.6L V8 6599cc 403 CID	1963-1964	<b>FORD COUNTRY SQUIRE</b>	7.0L V8 6997cc 427 CID		
<b>US470</b>		1956-1962	<b>JEEP UTILITY WAGON</b>	3.7L L6 3704cc 226 CID	1963-1964	<b>FORD GALAXIE</b>	7.0L V8 6997cc 427 CID	
	1954	<b>FORD COURIER SEDAN DELIVERY</b>	3.9L V8 3917cc 239 CID	1963-1964	<b>FORD RANCH WAGON</b>	7.0L V8 6997cc 427 CID		
	1954	<b>FORD CRESTLINE</b>	3.9L V8 3917cc 239 CID	1963-1964	<b>FORD THUNDERBIRD</b>	7.0L V8 6997cc 427 CID		
	1954	<b>FORD CUSTOMLINE</b>	3.9L V8 3917cc 239 CID	1963-1964	<b>MERCURY COLONY PARK</b>	7.0L V8 6997cc 427 CID		
	1954	<b>FORD MAINLINE</b>	3.9L V8 3917cc 239 CID	1963-1964	<b>MERCURY COMMUTER</b>	7.0L V8 6997cc 427 CID		
	1954	<b>MERCURY CUSTOM</b>	4.2L V8 4196cc 256 CID	1963-1964	<b>MERCURY MARAUDER</b>	6.4L V8 6391cc 390 CID		
	1954	<b>MERCURY MONTEREY</b>	4.2L V8 4196cc 256 CID	1963-1964	<b>MERCURY MARAUDER</b>	7.0L V8 6997cc 427 CID		
	1955-1956	<b>FORD CUSTOMLINE</b>	4.4L V8 4458cc 272 CID	1963-1964	<b>MERCURY MONTEREY</b>	7.0L V8 6997cc 427 CID		
	1955-1956	<b>FORD MAINLINE</b>	4.4L V8 4458cc 272 CID	1964	<b>FORD CUSTOM 500</b>	5.8L V8 352 CID		
	1955-1957	<b>FORD COURIER SEDAN DELIVERY</b>	4.4L V8 4458cc 272 CID	1964	<b>FORD CUSTOM 500</b>	6.4L V8 390 CID		
	1955-1957	<b>FORD FAIRLANE</b>	4.4L V8 4458cc 272 CID	1964	<b>FORD FAIRLANE</b>	7.0L V8 6997cc 427 CID		
	1956	<b>MERCURY CUSTOM</b>	5.1L V8 5114cc 312 CID	1964	<b>FORD GT40</b>	7.0L V8 6997cc 427 CID		
	1956	<b>MERCURY MEDALIST</b>	5.1L V8 5114cc 312 CID	1964	<b>MERCURY MONTCLAIR</b>	6.4L V8 6391cc 390 CID		
	1956-1957	<b>FORD THUNDERBIRD</b>	5.1L V8 5114cc 312 CID	1964	<b>MERCURY MONTCLAIR</b>	7.0L V8 6997cc 427 CID		
	1956-1957	<b>MERCURY MONTCLAIR</b>	5.1L V8 5114cc 312 CID	1964	<b>MERCURY PARK LANE</b>	6.4L V8 6391cc 390 CID		
	1956-1957	<b>MERCURY MONTEREY</b>	5.1L V8 5114cc 312 CID	1964	<b>MERCURY PARK LANE</b>	7.0L V8 6997cc 427 CID		
	1956-1958	<b>FORD F-100</b>	4.4L V8 4458cc 272 CID	<b>US773</b>	1965-1967	<b>OLDSMOBILE 98</b>	7.0L V8 6966cc 425 CID	
	1956-1958	<b>FORD F-250</b>	4.4L V8 4458cc 272 CID		1965-1967	<b>OLDSMOBILE DELTA 88</b>	7.0L V8 6966cc 425 CID	
	1956-1958	<b>FORD F-350</b>	4.4L V8 4458cc 272 CID		1968-1970	<b>OLDSMOBILE 98</b>	7.5L V8 7456cc 455 CID	
	1956-1958	<b>FORD F-350</b>	4.4L V8 4458cc 272 CID		1968-1970	<b>OLDSMOBILE DELTA 88</b>	7.5L V8 7456cc 455 CID	
1957	<b>FORD CUSTOM</b>	4.8L V8 4786cc 292 CID	<b>US819</b>		1962	<b>FORD FAIRLANE</b>	3.6L L6 3655cc 223 CID	
1957	<b>FORD FAIRLANE</b>	4.5L V8 272 CID			1962	<b>FORD FALCON SEDAN DELIVERY</b>	4.3L V8 4261cc 260 CID	
1957	<b>FORD RANCHERO</b>	4.4L V8 4458cc 272 CID			1962-1963	<b>FORD COUNTRY SEDAN</b>	3.6L V8 3622cc 221 CID	
1957	<b>FORD THUNDERBIRD</b>	4.8L V8 4786cc 292 CID			1962-1963	<b>FORD COUNTRY SQUIRE</b>	3.6L V8 3622cc 221 CID	
1957-1958	<b>FORD COURIER SEDAN DELIVERY</b>	4.8L V8 4786cc 292 CID			1962-1963	<b>FORD FAIRLANE</b>	3.6L V8 221 CID	
1957-1959	<b>FORD RANCHERO</b>	4.8L V8 4786cc 292 CID			1962-1963	<b>FORD FAIRLANE</b>	3.6L V8 3622cc 221 CID	
1957-1961	<b>FORD FAIRLANE</b>	4.8L V8 292 CID			1962-1963	<b>FORD FALCON</b>	3.6L V8 3622cc 221 CID	
1958	<b>MERCURY MEDALIST</b>	5.1L V8 5114cc 312 CID			1962-1964	<b>FORD FAIRLANE</b>	4.3L V8 4261cc 260 CID	
1958-1960	<b>FORD CUSTOM 300</b>	4.8L V8 4786cc 292 CID		1962-1965	<b>FORD COUNTRY SEDAN</b>	4.3L V8 4261cc 260 CID		
1958-1963	<b>FORD F-100</b>	4.8L V8 4786cc 292 CID		1962-1965	<b>FORD COUNTRY SQUIRE</b>	4.3L V8 4261cc 260 CID		
1958-1963	<b>FORD F-250</b>	4.8L V8 4786cc 292 CID		1962-1965	<b>FORD FALCON</b>	4.3L V8 4261cc 260 CID		
1958-1963	<b>FORD F-350</b>	4.8L V8 4786cc 292 CID		1963	<b>FORD FORD 300</b>	4.3L V8 4261cc 260 CID		
1959-1960	<b>EDSEL RANGER</b>	4.8L V8 4786cc 292 CID						



USMW	Years	Application	Engine	USMW	Years	Application	Engine	
<b>US819</b>	1963	FORD FORD 300	4.7L V8 4727cc 289 CID	<b>US855</b>	1964	BUICK SPORTWAGON	3.7L V6 3687cc 225 CID	
	1963-1964	FORD FAIRLANE	4.3L V8 260 CID		1964-1965	BUICK LESABRE	4.9L V8 4917cc 300 CID	
	1963-1964	FORD FALCON	4.3L V8 260 CID		1964-1965	BUICK SPORTWAGON	4.9L V8 4917cc 300 CID	
	1963-1964	FORD GALAXIE	4.3L V8 4261cc 260 CID		1964-1967	BUICK SKYLARK	3.7L V6 3687cc 225 CID	
	1963-1964	FORD GALAXIE 500	4.3L V8 260 CID		1964-1967	BUICK SKYLARK	4.9L V8 4917cc 300 CID	
	1963-1965	FORD COUNTRY SQUIRE	4.7L V8 4727cc 289 CID		1964-1967	BUICK SPECIAL	3.7L V6 3687cc 225 CID	
	1963-1965	FORD GALAXIE	4.7L V8 4727cc 289 CID		1964-1967	BUICK SPECIAL	4.9L V8 4917cc 300 CID	
	1963-1967	FORD COUNTRY SEDAN	4.7L V8 4727cc 289 CID		1965	BUICK LESABRE	4.9L V8 300 CID	
	1963-1967	FORD FAIRLANE	4.7L V8 289 CID		1966	JEEP CJ3	3.7L V6 3687cc 225 CID	
	1963-1967	FORD FAIRLANE	4.7L V8 4727cc 289 CID		1966	JEEP FC150	3.7L L6 3704cc 226 CID	
	1963-1967	FORD GALAXIE 500	4.7L V8 289 CID		1966	JEEP FC150	3.7L V6 3687cc 225 CID	
	1964	FORD CUSTOM 500	4.3L V8 260 CID		1966	JEEP FC170HD	3.7L L6 3687cc 225 CID	
	1964-1965	FORD MUSTANG	4.3L V8 4261cc 260 CID		1966-1968	JEEP CJ5A	3.7L V6 3687cc 225 CID	
	1964-1966	FORD FALCON	4.7L V8 289 CID		1966-1968	JEEP CJ6A	3.7L V6 3687cc 225 CID	
	1964-1966	FORD FALCON	4.7L V8 4727cc 289 CID		1966-1968	JEEP DJ6	3.7L V6 3687cc 225 CID	
	1964-1967	FORD CUSTOM 500	4.7L V8 289 CID		1966-1969	JEEP DISPATCHER	3.7L V6 3687cc 225 CID	
	1964-1968	FORD MUSTANG	4.7L V8 4727cc 289 CID		1966-1971	JEEP CJ5	3.7L V6 3687cc 225 CID	
	1965	FORD CUSTOM	4.7L V8 4727cc 289 CID		1966-1971	JEEP CJ6	3.7L V6 3687cc 225 CID	
	1965	FORD FALCON SEDAN DELIVERY	4.7L V8 4727cc 289 CID		1966-1971	JEEP COMMANDO	3.7L V6 3687cc 225 CID	
	1965-1966	FORD F100	4.7L V8 4700cc 289 CID		1966-1971	JEEP DJ5	3.7L V6 3687cc 225 CID	
	1965-1966	FORD F350	4.7L V8 4700cc 289 CID		1968	JEEP CJ6	3.7L V6 225 CID	
	1965-1966	FORD F350	5.0L V8 5000cc 302 CID		1968-1969	BUICK GS 350	5.7L V8 350 CID	
	1965-1967	FORD LTD	4.7L V8 4727cc 289 CID		1968-1969	BUICK GS 350	5.7L V8 5736cc 350 CID	
	1966-1968	FORD GT40	4.7L V8 4727cc 289 CID		1968-1969	BUICK SPECIAL	5.7L V8 5736cc 350 CID	
	1968	FORD GT40	4.7L V8 289 CID		1968-1970	BUICK LESABRE	5.7L V8 350 CID	
	1968	FORD MUSTANG	4.7L V8 289 CID		1968-1970	BUICK LESABRE	5.7L V8 5736cc 350 CID	
	<b>US821</b>	1967-1969	BUICK ELECTRA		7.0L V8 7047cc 430 CID	1968-1970	BUICK SKYLARK	5.7L V8 350 CID
		1967-1969	BUICK RIVIERA		7.0L V8 7047cc 430 CID	1968-1970	BUICK SKYLARK	5.7L V8 5736cc 350 CID
		1967-1969	BUICK WILDCAT		7.0L V8 7047cc 430 CID	1968-1970	BUICK SPORTWAGON	5.7L V8 5736cc 350 CID
		1970	BUICK WILDCAT		7.5L V8 7456cc 455 CID	1968-1971	JEEP J-100	5.7L V8 5736cc 350 CID
		1970-1972	BUICK ELECTRA		7.5L V8 7456cc 455 CID	1969-1970	JEEP J-2600	5.7L V8 350 CID
		1970-1972	BUICK ESTATE WAGON		7.5L V8 7456cc 455 CID	1969-1970	JEEP J-2700	5.7L V8 350 CID
		1970-1972	BUICK LESABRE		7.5L V8 7456cc 455 CID	1969-1970	JEEP J-2700	5.7L V8 5736cc 350 CID
1970-1972		BUICK RIVIERA	7.5L V8 7456cc 455 CID	1969-1971	JEEP J-100	5.7L V8 350 CID		
1971-1972		BUICK CENTURION	7.5L V8 7456cc 455 CID	1969-1971	JEEP J-2500	5.7L V8 350 CID		
<b>US835</b>		1967-1973	CHEVROLET C60	7.8L V6 7828cc 478 CID	1969-1971	JEEP J-2500	5.7L V8 5736cc 350 CID	
		1968-1969	GMC C15/C1500 PICKUP	5.0L V6 5012cc 305 CID	1969-1971	JEEP J-2600	5.7L V8 5736cc 350 CID	
	1968-1969	GMC C25/C2500 PICKUP	5.0L V6 5012cc 305 CID	1970	BUICK ESTATE WAGON	5.7L V8 350 CID		
	1968-1969	GMC C35/C3500 PICKUP	5.0L V6 5012cc 305 CID	1970	BUICK ESTATE WAGON	5.7L V8 5736cc 350 CID		
	1968-1969	GMC K15/K1500 PICKUP	5.0L V6 5012cc 305 CID	1970	BUICK GS	5.7L V8 350 CID		
	1968-1969	GMC K25/K2500 PICKUP	5.0L V6 5012cc 305 CID	1970	BUICK GS	5.7L V8 5736cc 350 CID		
	<b>US843</b>	1966	AMERICAN MOTORS CLASSIC	3.3L L6 3261cc 199 CID	<b>US861</b>	1966-1978	CHEVROLET C50	6.0L V8 5999cc 366 CID
1966-1970		AMERICAN MOTORS CLASSIC	3.3L L6 3300cc 199 CID	1966-1978		CHEVROLET C60	6.0L V8 5999cc 366 CID	
1967-1973		AMERICAN MOTORS CLASSIC	3.8L L6 3800cc 232 CID	1969-1978		CHEVROLET C50	7.0L V8 6998cc 427 CID	
1969-1970		AMERICAN MOTORS AMERICAN	3.3L L6 3300cc 199 CID	1969-1978		CHEVROLET C60	7.0L V8 6998cc 427 CID	
1969-1973		AMERICAN MOTORS AMERICAN	3.8L L6 3800cc 232 CID	<b>US895</b>		1964-1966	CHEVROLET CHEVELLE	4.1L L6 4100cc 250 CID
1972		AMERICAN MOTORS CLASSIC	4.2L L6 4200cc 258 CID			1965	CHEVROLET IMPALA	4.1L L6 4100cc 250 CID
1972		AMERICAN MOTORS CLASSIC	4.6L L6 4600cc 282 CID			1965	CHEVROLET MALIBU	4.1L L6 4100cc 250 CID
<b>US850</b>	1959-1962	PONTIAC BONNEVILLE	6.4L V8 389 CID		1965-1972	CHEVROLET IMPALA	4.8L L6 4800cc 292 CID	
	1959-1966	PONTIAC BONNEVILLE	6.4L V8 6376cc 389 CID		1966-1974	CHEVROLET CS1073	4.1L L6 4100cc 250 CID	
	1959-1966	PONTIAC CATALINA	6.4L V8 6376cc 389 CID		1970	CHEVROLET CHEVELLE	3.8L L6 3800cc 230 CID	
	1959-1966	PONTIAC STAR CHIEF	6.4L V8 6376cc 389 CID		1975	GMC SPRINT	4.1L L6 250 CID	
	1960-1961	PONTIAC VENTURA	6.4L V8 6376cc 389 CID	1994-1997	CHEVROLET C1500	4.1L L6 4100cc 250 CID		
	1961	PONTIAC TEMPEST	6.4L V8 6376cc 389 CID	1994-1997	GMC C1500	4.1L L6 4100cc 250 CID		
	1961	PONTIAC VENTURA	6.9L V8 6900cc 421 CID	<b>US896</b>	1964-1974	CHEVROLET CS1073	4.8L L6 4800cc 292 CID	
	1961-1966	PONTIAC CATALINA	6.9L V8 6900cc 421 CID		1965	GMC PB1500 SERIES	4.8L L6 4801cc 292 CID	
	1962-1966	PONTIAC GRAND PRIX	6.4L V8 6376cc 389 CID		1965	GMC PB2500 SERIES	4.8L L6 4801cc 292 CID	
	1963-1966	PONTIAC BONNEVILLE	6.9L V8 6900cc 421 CID		1965-1966	CHEVROLET C1405	4.8L L6 4800cc 292 CID	
	1963-1966	PONTIAC GRAND PRIX	6.9L V8 6900cc 421 CID		1965-1966	CHEVROLET SUBURBAN	4.8L L6 4801cc 292 CID	
	1963-1966	PONTIAC STAR CHIEF	6.9L V8 6900cc 421 CID		1965-1966	GMC SUBURBAN	4.8L L6 4801cc 292 CID	
	1964-1966	PONTIAC GTO	6.4L V8 6376cc 389 CID		1965-1967	CHEVROLET C20905	4.8L L6 4800cc 292 CID	
	1967-1968	PONTIAC BONNEVILLE	6.6L V8 6555cc 400 CID		1965-1967	CHEVROLET P20 SERIES	4.8L L6 4801cc 292 CID	
	1967-1968	PONTIAC BONNEVILLE	7.0L V8 7014cc 428 CID		1965-1967	CHEVROLET P30 SERIES	4.8L L6 4801cc 292 CID	
	1967-1968	PONTIAC CATALINA	6.6L V8 400 CID		1965-1974	CHEVROLET C10 PICKUP	4.8L L6 4801cc 292 CID	
	1967-1968	PONTIAC CATALINA	6.6L V8 6555cc 400 CID		1965-1974	CHEVROLET C30 PICKUP	4.8L L6 4801cc 292 CID	
	1967-1968	PONTIAC CATALINA	7.0L V8 7014cc 428 CID	1965-1974	CHEVROLET CS31003	4.8L L6 4800cc 292 CID		
	1967-1968	PONTIAC EXECUTIVE	6.6L V8 6555cc 400 CID	1965-1974	CHEVROLET K10 PICKUP	4.8L L6 4801cc 292 CID		
	1967-1968	PONTIAC EXECUTIVE	7.0L V8 7014cc 428 CID	1965-1974	CHEVROLET K20 PICKUP	4.8L L6 4801cc 292 CID		
	1967-1968	PONTIAC FIREBIRD	6.6L V8 400 CID	1966	GMC PB15 SERIES	4.8L L6 4801cc 292 CID		
	1967-1968	PONTIAC FIREBIRD	6.6L V8 6555cc 400 CID	1966	GMC PB25 SERIES	4.8L L6 4801cc 292 CID		
	1967-1968	PONTIAC GRAND PRIX	6.6L V8 6555cc 400 CID	1967	CHEVROLET C3605	4.8L L6 4800cc 292 CID		
	1967-1968	PONTIAC GRAND PRIX	7.0L V8 7014cc 428 CID	1967	CHEVROLET K10 SUBURBAN	4.8L L6 4801cc 292 CID		
	1967-1968	PONTIAC GTO	6.6L V8 400 CID	1967	CHEVROLET P10 SERIES	4.8L L6 4801cc 292 CID		
	1967-1968	PONTIAC GTO	6.6L V8 6555cc 400 CID	1967	GMC P15/P1500 VAN	4.8L L6 292 CID		
	1968	PONTIAC ACADIAN	5.7L V8 5736cc 350 CID	1967-1968	GMC K15/K1500 SUBURBAN	4.8L L6 4801cc 292 CID		
	1968	PONTIAC BONNEVILLE	6.6L V8 400 CID	1967-1970	CHEVROLET CHEVELLE	4.8L L6 4800cc 292 CID		
	1968	PONTIAC BONNEVILLE	7.0L V8 428 CID	1967-1974	CHEVROLET C10 SUBURBAN	4.8L L6 4801cc 292 CID		
	1968	PONTIAC CATALINA	7.0L V8 428 CID	1967-1974	CHEVROLET C20 SUBURBAN	4.8L L6 4801cc 292 CID		
	1968	PONTIAC FIREBIRD	5.7L V8 350 CID	1967-1974	CHEVROLET K20 SUBURBAN	4.8L L6 4801cc 292 CID		
	1968	PONTIAC FIREBIRD	5.7L V8 5733cc 350 CID	1967-1974	GMC K15/K1500 PICKUP	4.8L L6 4801cc 292 CID		
	1968	PONTIAC GRAND PRIX	6.6L V8 400 CID	1967-1974	GMC K25/K2500 PICKUP	4.8L L6 4801cc 292 CID		
1968	PONTIAC GRAND PRIX	7.0L V8 428 CID	1967-1974	GMC P25/P2500 VAN	4.8L L6 292 CID			
1968	PONTIAC LEMANS	5.7L V8 350 CID	1967-1974	GMC P35/P3500 VAN	4.8L L6 292 CID			
1968	PONTIAC LEMANS	5.7L V8 5733cc 350 CID	1968	GMC K15/K1500 PICKUP	4.8L L6 292 CID			
1968	PONTIAC LEMANS	6.6L V8 400 CID	1968	GMC K15/K1500 SUBURBAN	4.8L L6 292 CID			
1968	PONTIAC LEMANS	6.6L V8 6555cc 400 CID	1968	GMC K25/K2500 PICKUP	4.8L L6 292 CID			
1968	PONTIAC TEMPEST	5.7L V8 5733cc 350 CID	1968-1971	CHEVROLET C10 PICKUP	4.8L L6 292 CID			
1968	PONTIAC TEMPEST	6.6L V8 6555cc 400 CID	1968-1971	CHEVROLET C10 SUBURBAN	4.8L L6 292 CID			
<b>US855</b>	1964	BUICK ESTATE WAGON	4.9L V8 4917cc 300 CID	1968-1974	CHEVROLET C20 SUBURBAN	4.8L L6 292 CID		

WATER PUMPS



USMW	Years	Application	Engine	USMW	Years	Application	Engine	
<b>US896</b>	1968-1974	CHEVROLET C30 PICKUP	4.8L L6 292 CID	<b>US898</b>	1960	CHEVROLET TRUCK	4.6L V8 4638cc 283 CID	
	1968-1974	CHEVROLET K20 SUBURBAN	4.8L L6 292 CID		1960	CHEVROLET TRUCK	5.7L V8 5704cc 348 CID	
	1968-1974	CHEVROLET K30 PICKUP	4.8L L6 292 CID		1960-1961	CHEVROLET C10 PICKUP	5.7L V8 5704cc 348 CID	
	1968-1974	CHEVROLET K30 PICKUP	4.8L L6 4801cc 292 CID		1960-1961	CHEVROLET C20 PICKUP	5.7L V8 5704cc 348 CID	
	1968-1974	CHEVROLET P20 VAN	4.8L L6 292 CID		1960-1961	CHEVROLET C30 PICKUP	5.7L V8 5704cc 348 CID	
	1968-1974	CHEVROLET P30 VAN	4.8L L6 292 CID		1960-1961	CHEVROLET K10 PICKUP	5.7L V8 5704cc 348 CID	
	1968-1974	GMC K25/K2500 SUBURBAN	4.8L L6 292 CID		1960-1961	CHEVROLET K20 PICKUP	5.7L V8 5704cc 348 CID	
	1968-1974	GMC K25/K2500 SUBURBAN	4.8L L6 4801cc 292 CID		1960-1961	CHEVROLET SUBURBAN	5.7L V8 5704cc 348 CID	
	1968-1974	GMC K35/K3500 PICKUP	4.8L L6 292 CID		1960-1965	CHEVROLET P30 SERIES	5.7L V8 5704cc 348 CID	
	1968-1974	GMC K35/K3500 PICKUP	4.8L L6 4801cc 292 CID		1960-1966	CHEVROLET SUBURBAN	4.6L V8 4638cc 283 CID	
	1969-1970	CHEVROLET K10 PICKUP	4.8L L6 292 CID		1960-1967	CHEVROLET C10 PICKUP	4.6L V8 4638cc 283 CID	
	1969-1970	CHEVROLET K10 SUBURBAN	4.8L L6 292 CID		1960-1967	CHEVROLET C20 PICKUP	4.6L V8 4638cc 283 CID	
	1969-1974	CHEVROLET BLAZER	4.8L L6 4801cc 292 CID		1960-1967	CHEVROLET C30 PICKUP	4.6L V8 4638cc 283 CID	
	1969-1974	CHEVROLET K20 PICKUP	4.8L L6 292 CID		1960-1967	CHEVROLET K10 PICKUP	4.6L V8 4638cc 283 CID	
	1970	CHEVROLET BLAZER	4.8L L6 292 CID		1960-1967	CHEVROLET K20 PICKUP	4.6L V8 4638cc 283 CID	
	1970-1971	GMC K15/K1500 PICKUP	4.8L L6 292 CID		1961-1962	CHEVROLET C10 PICKUP	4.3L L6 4278cc 261 CID	
	1970-1971	GMC K15/K1500 SUBURBAN	4.8L L6 292 CID		1961-1962	CHEVROLET C20 PICKUP	4.3L L6 4278cc 261 CID	
	1970-1971	GMC K15/K1500 SUBURBAN	4.8L L6 4801cc 292 CID		1961-1962	CHEVROLET C30 PICKUP	4.3L L6 4278cc 261 CID	
	1970-1974	GMC JIMMY	4.8L L6 4801cc 292 CID		1961-1962	CHEVROLET K10 PICKUP	4.3L L6 4278cc 261 CID	
	1970-1974	GMC K25/K2500 PICKUP	4.8L L6 292 CID		1961-1962	CHEVROLET K20 PICKUP	4.3L L6 4278cc 261 CID	
	1971	CHEVROLET G20 VAN	4.8L L6 292 CID		1961-1962	CHEVROLET P10 SERIES	4.3L L6 4278cc 261 CID	
	1971-1972	CHEVROLET G30 VAN	4.8L L6 292 CID		1961-1962	CHEVROLET P10 SERIES	4.6L V8 4638cc 283 CID	
	1971-1974	CHEVROLET G20 VAN	4.8L L6 4801cc 292 CID		1961-1962	CHEVROLET P30 SERIES	4.3L L6 4278cc 261 CID	
	1972-1973	CHEVROLET K10 PICKUP	4.8L L6 292 CID		1961-1962	CHEVROLET P30 SERIES	4.6L V8 4638cc 283 CID	
	1972-1973	CHEVROLET K10 PICKUP	4.8L L6 4786cc 292 CID		1961-1962	CHEVROLET SUBURBAN	4.3L L6 4278cc 261 CID	
	1972-1974	CHEVROLET K20 PICKUP	4.8L L6 4786cc 292 CID		1962-1968	CHEVROLET CORVETTE	5.3L V8 5358cc 327 CID	
	1973	CHEVROLET BLAZER	4.8L L6 292 CID		1962-1969	CHEVROLET BEL AIR	5.3L V8 5358cc 327 CID	
	1973	CHEVROLET BLAZER	4.8L L6 4786cc 292 CID		1962-1969	CHEVROLET BISCAYNE	5.3L V8 5358cc 327 CID	
	1973	CHEVROLET CHEVELLE	4.8L L6 4800cc 292 CID		1962-1969	CHEVROLET IMPALA	5.3L V8 5358cc 327 CID	
	1973	GMC JIMMY	4.8L L6 292 CID		1963-1967	CHEVROLET CHEVY II	4.6L V8 4638cc 283 CID	
	1973	GMC JIMMY	4.8L L6 4786cc 292 CID		1964	CHEVROLET IMPALA	4.6L V8 283 CID	
	1973-1974	CHEVROLET C10 PICKUP	4.8L L6 292 CID		1964-1966	CHEVROLET CHEVY II	4.6L V8 283 CID	
	1973-1974	CHEVROLET C10 PICKUP	4.8L L6 4786cc 292 CID		1964-1967	CHEVROLET CHEVELLE	4.6L V8 4638cc 283 CID	
	1973-1974	CHEVROLET C10 SUBURBAN	4.8L L6 292 CID		1964-1967	CHEVROLET CS1073	4.7L V8 4738cc 283 CID	
	1973-1974	CHEVROLET C10 SUBURBAN	4.8L L6 4786cc 292 CID		1964-1967	CHEVROLET CS31003	4.7L V8 4738cc 283 CID	
	1973-1974	CHEVROLET C20 SUBURBAN	4.8L L6 4786cc 292 CID		1964-1967	CHEVROLET EL CAMINO	4.6L V8 4638cc 283 CID	
	1973-1974	CHEVROLET C30 PICKUP	4.8L L6 4786cc 292 CID		1964-1967	CHEVROLET MALIBU	4.6L V8 4638cc 283 CID	
	1973-1974	CHEVROLET G20 VAN	4.8L L6 292 CID		1964-1967	CHEVROLET MALIBU	5.3L V8 5358cc 327 CID	
	1973-1974	CHEVROLET G20 VAN	4.8L L6 4786cc 292 CID		1964-1968	CHEVROLET CHEVELLE	5.3L V8 5358cc 327 CID	
	1973-1974	CHEVROLET K20 SUBURBAN	4.8L L6 4786cc 292 CID		1964-1969	CHEVROLET CS1073	5.4L V8 5400cc 327 CID	
	1973-1974	CHEVROLET K30 PICKUP	4.8L L6 4786cc 292 CID		1964-1969	CHEVROLET CS31003	5.4L V8 5400cc 327 CID	
	1973-1974	CHEVROLET P20 VAN	4.8L L6 4786cc 292 CID		1964-1969	CHEVROLET IMPALA	5.4L V8 327 CID	
	1973-1974	CHEVROLET P30 VAN	4.8L L6 4786cc 292 CID		1965	CHEVROLET CHEVELLE	5.4L V8 327 CID	
	1973-1974	GMC K25/K2500 PICKUP	4.8L L6 4786cc 292 CID		1965-1966	CHEVROLET C1405	4.7L V8 4738cc 283 CID	
	1973-1974	GMC K25/K2500 SUBURBAN	4.8L L6 4786cc 292 CID		1965-1966	CHEVROLET CHEVY II	5.4L V8 327 CID	
	1973-1974	GMC K35/K3500 PICKUP	4.8L L6 4786cc 292 CID		1965-1967	CHECKER MARATHON	4.6L V8 4638cc 283 CID	
	1973-1974	GMC P25/P2500 VAN	4.8L L6 4786cc 292 CID		1965-1967	CHEVROLET C20905	4.7L V8 4738cc 283 CID	
	1973-1974	GMC P35/P3500 VAN	4.8L L6 4786cc 292 CID		1965-1967	CHEVROLET CHEVELLE	4.6L V8 283 CID	
	1974	CHEVROLET G30 VAN	4.8L L6 292 CID		1965-1968	CHEVROLET CHEVY II	5.3L V8 5358cc 327 CID	
	1974	CHEVROLET G30 VAN	4.8L L6 4786cc 292 CID		1965-1969	AVANTI II	5.3L V8 5358cc 327 CID	
	1974	GMC K15/K1500 PICKUP	4.8L L6 292 CID		1965-1969	CHECKER MARATHON	5.3L V8 5358cc 327 CID	
	1982-1986	CHEVROLET C10	4.8L L6 4800cc 292 CID		1966	CHEVROLET SUBURBAN	5.3L V8 5358cc 327 CID	
	<b>US898</b>	1955-1956	CHEVROLET CORVETTE		4.3L V8 4343cc 265 CID	1966-1967	CHEVROLET CAPRICE	4.6L V8 4638cc 283 CID
		1955-1956	CHEVROLET TRUCK		5.3L V8 5310cc 324 CID	1966-1967	CHEVROLET IMPALA	4.6L V8 283 CID
		1955-1957	CHEVROLET BEL AIR		4.3L V8 265 CID	1966-1969	CHEVROLET C10 PICKUP	5.3L V8 5358cc 327 CID
		1955-1957	CHEVROLET BEL AIR		4.3L V8 4343cc 265 CID	1966-1969	CHEVROLET C20 PICKUP	5.3L V8 5358cc 327 CID
		1955-1957	CHEVROLET ONE-FIFTY SERIES		4.3L V8 4343cc 265 CID	1966-1969	CHEVROLET C30 PICKUP	5.3L V8 5358cc 327 CID
		1955-1957	CHEVROLET TRUCK		4.3L V8 4343cc 265 CID	1966-1969	CHEVROLET CAPRICE	5.3L V8 5358cc 327 CID
1955-1957		CHEVROLET TWO-TEN SERIES	4.3L V8 4343cc 265 CID	1966-1969	CHEVROLET EL CAMINO	5.3L V8 5358cc 327 CID		
1955-1958		CHEVROLET TRUCK	4.3L L6 4278cc 261 CID	1966-1969	CHEVROLET K10 PICKUP	5.3L V8 5358cc 327 CID		
1956-1958		CHEVROLET TRUCK	5.3L V8 5272cc 322 CID	1966-1969	CHEVROLET K20 PICKUP	5.3L V8 5358cc 327 CID		
1957		CHEVROLET BEL AIR	4.6L V8 283 CID	1967	CHEVROLET C10 SUBURBAN	4.6L V8 4638cc 283 CID		
1957		CHEVROLET DEL RAY	4.3L V8 4343cc 265 CID	1967	CHEVROLET C20 SUBURBAN	4.6L V8 4638cc 283 CID		
1957		CHEVROLET ONE-FIFTY SERIES	4.6L V8 4638cc 283 CID	1967	CHEVROLET C3605	4.7L V8 4738cc 283 CID		
1957		CHEVROLET TWO-TEN SERIES	4.6L V8 4638cc 283 CID	1967	CHEVROLET G20 VAN	4.6L V8 4638cc 283 CID		
1957-1958		CHEVROLET DEL RAY	4.6L V8 4638cc 283 CID	1967	CHEVROLET K10 SUBURBAN	4.6L V8 4638cc 283 CID		
1957-1958		CHEVROLET TRUCK	4.6L V8 4638cc 283 CID	1967	CHEVROLET K20 PANEL	4.6L V8 283 CID		
1957-1961		CHEVROLET CORVETTE	4.6L V8 4638cc 283 CID	1967	CHEVROLET K20 PANEL	5.4L V8 327 CID		
1957-1967		CHEVROLET BEL AIR	4.6L V8 4638cc 283 CID	1967	CHEVROLET K20 SUBURBAN	4.6L V8 4638cc 283 CID		
1958		CHEVROLET BROOKWOOD	4.6L V8 283 CID	1967-1968	CHEVROLET CHEVELLE	5.4L V8 327 CID		
1958		CHEVROLET BROOKWOOD	5.7L V8 348 CID	1967-1969	CHEVROLET C10 SUBURBAN	5.3L V8 5358cc 327 CID		
1958		CHEVROLET DEL RAY	5.7L V8 5704cc 348 CID	1967-1969	CHEVROLET C20 SUBURBAN	5.3L V8 5358cc 327 CID		
1958		CHEVROLET TRUCK	5.7L V8 5704cc 348 CID	1967-1969	CHEVROLET CAMARO	5.3L V8 5358cc 327 CID		
1958-1961		CHEVROLET BEL AIR	5.7L V8 5704cc 348 CID	1967-1969	CHEVROLET K10 SUBURBAN	5.3L V8 5358cc 327 CID		
1958-1961		CHEVROLET BISCAYNE	5.7L V8 5704cc 348 CID	1967-1969	CHEVROLET K20 SUBURBAN	5.3L V8 5358cc 327 CID		
1958-1961		CHEVROLET IMPALA	5.7L V8 5704cc 348 CID	1967-1972	CHEVROLET CAMARO	5.7L V8 5736cc 350 CID		
1958-1967		CHEVROLET BISCAYNE	4.6L V8 4638cc 283 CID	1968	CHECKER MARATHON	5.0L V8 307 CID		
1958-1967		CHEVROLET IMPALA	4.6L V8 4638cc 283 CID	1968	CHECKER MARATHON	5.0L V8 5031cc 307 CID		
1959		CHEVROLET BEL AIR	5.3L V8 5272cc 322 CID	1968	CHEVROLET BEL AIR	5.0L V8 307 CID		
1959-1960		CHEVROLET BEL AIR	4.3L L6 4278cc 261 CID	1968	CHEVROLET BEL AIR	5.0L V8 5031cc 307 CID		
1959-1960		CHEVROLET EL CAMINO	4.6L V8 4638cc 283 CID	1968	CHEVROLET BISCAYNE	5.0L V8 307 CID		
1959-1960		CHEVROLET EL CAMINO	5.7L V8 5704cc 348 CID	1968	CHEVROLET BISCAYNE	5.0L V8 5031cc 307 CID		
1959-1961		CHEVROLET BROOKWOOD	4.6L V8 4638cc 283 CID	1968	CHEVROLET C10 PICKUP	5.4L V8 327 CID		
1959-1961		CHEVROLET BROOKWOOD	5.7L V8 5704cc 348 CID	1968	CHEVROLET C10 SUBURBAN	5.4L V8 327 CID		
1959-1961		CHEVROLET KINGSWOOD	4.6L V8 4638cc 283 CID	1968	CHEVROLET C20 PICKUP	5.4L V8 327 CID		
1959-1961		CHEVROLET KINGSWOOD	5.7L V8 5704cc 348 CID	1968	CHEVROLET C20 SUBURBAN	5.4L V8 327 CID		
1960		CHEVROLET BISCAYNE	4.6L V8 283 CID	1968	CHEVROLET C30 PICKUP	5.4L V8 327 CID		
1960		CHEVROLET BISCAYNE	5.7L V8 348 CID	1968	CHEVROLET CAPRICE	5.0L V8 307 CID		
1960		CHEVROLET TRUCK	4.3L L6 4278cc 261 CID	1968	CHEVROLET CHEVY II	5.0L V8 307 CID		



# WATER PUMP BUYERS GUIDE



USMW	Years	Application	Engine	USMW	Years	Application	Engine	
<b>US898</b>	1968	CHEVROLET CHEVY II	5.0L V8 5031cc 307 CID	<b>US898</b>	1969-1972	CHEVROLET IMPALA	5.7L V8 5736cc 350 CID	
	1968	CHEVROLET CHEVY II	5.4L V8 327 CID		1969-1972	CHEVROLET K10 PICKUP	5.7L V8 350 CID	
	1968	CHEVROLET CHEVY II	5.7L V8 350 CID		1969-1972	CHEVROLET K10 PICKUP	5.7L V8 5736cc 350 CID	
	1968	CHEVROLET CHEVY II	5.7L V8 5736cc 350 CID		1969-1972	CHEVROLET K10 SUBURBAN	5.7L V8 350 CID	
	1968	CHEVROLET CORVETTE	5.4L V8 327 CID		1969-1972	CHEVROLET K10 SUBURBAN	5.7L V8 5736cc 350 CID	
	1968	CHEVROLET EL CAMINO	5.4L V8 327 CID		1969-1972	CHEVROLET K20 PICKUP	5.7L V8 350 CID	
	1968	CHEVROLET IMPALA	5.0L V8 307 CID		1969-1972	CHEVROLET K20 PICKUP	5.7L V8 5736cc 350 CID	
	1968	CHEVROLET K10 PICKUP	5.4L V8 327 CID		1969-1972	CHEVROLET K20 SUBURBAN	5.7L V8 350 CID	
	1968	CHEVROLET K10 SUBURBAN	5.4L V8 327 CID		1969-1972	CHEVROLET K20 SUBURBAN	5.7L V8 5736cc 350 CID	
	1968	CHEVROLET K20 PICKUP	5.4L V8 327 CID		1969-1972	CHEVROLET K30 PICKUP	5.7L V8 350 CID	
	1968	CHEVROLET K20 SUBURBAN	5.4L V8 327 CID		1969-1972	CHEVROLET K30 PICKUP	5.7L V8 5736cc 350 CID	
	1968	CHEVROLET K30 PICKUP	5.4L V8 327 CID		1969-1972	CHEVROLET KINGSWOOD	5.7L V8 350 CID	
	1968-1969	AVANTI II	5.4L V8 327 CID		1969-1972	CHEVROLET KINGSWOOD	5.7L V8 5736cc 350 CID	
	1968-1969	CHEVROLET BEL AIR	5.4L V8 327 CID		1970-1972	CHEVROLET G10 VAN	5.7L V8 350 CID	
	1968-1969	CHEVROLET BISCAYNE	5.4L V8 327 CID		1970-1972	CHEVROLET G20 VAN	5.7L V8 350 CID	
	1968-1969	CHEVROLET CAMARO	5.4L V8 327 CID		1970-1972	CHEVROLET G20 VAN	5.7L V8 5736cc 350 CID	
	1968-1969	CHEVROLET CAPRICE	5.0L V8 5031cc 307 CID		1970-1972	CHEVROLET G30 VAN	5.7L V8 350 CID	
	1968-1969	CHEVROLET CAPRICE	5.4L V8 327 CID		1970-1972	CHEVROLET G20 VAN	5.7L V8 350 CID	
	1968-1969	CHEVROLET IMPALA	5.0L V8 5031cc 307 CID		1970-1972	CHEVROLET P30 VAN	5.7L V8 350 CID	
	1968-1969	CHEVROLET K30 PICKUP	5.3L V8 5358cc 327 CID		1971-1972	CHEVROLET BROOKWOOD	5.0L V8 5031cc 307 CID	
	1968-1969	CHEVROLET P20 VAN	5.0L V8 307 CID		1971-1972	CHEVROLET CAPRICE	5.0L V8 5031cc 307 CID	
	1968-1969	CHEVROLET P30 VAN	5.0L V8 307 CID		1971-1972	CHEVROLET IMPALA	5.0L V8 5031cc 307 CID	
	1968-1970	CHEVROLET G20 VAN	5.0L V8 307 CID		1971-1972	CHEVROLET KINGSWOOD	5.0L V8 5031cc 307 CID	
	1968-1972	CHEVROLET C10 PICKUP	5.0L V8 307 CID		1972	CHEVROLET CAMARO	5.7L V8 5737cc 350 CID	
	1968-1972	CHEVROLET C10 PICKUP	5.0L V8 5031cc 307 CID		1972	CHEVROLET CORVETTE	5.7L V8 5737cc 350 CID	
	1968-1972	CHEVROLET C10 SUBURBAN	5.0L V8 307 CID		<b>US898H</b>	1955-1956	CHEVROLET CORVETTE	4.3L V8 4343cc 265 CID
	1968-1972	CHEVROLET C10 SUBURBAN	5.0L V8 5031cc 307 CID			1955-1956	CHEVROLET TRUCK	5.3L V8 5310cc 324 CID
	1968-1972	CHEVROLET C20 PICKUP	5.0L V8 307 CID			1955-1957	CHEVROLET BEL AIR	4.3L V8 265 CID
	1968-1972	CHEVROLET C20 PICKUP	5.0L V8 5031cc 307 CID			1955-1957	CHEVROLET BEL AIR	4.3L V8 4343cc 265 CID
	1968-1972	CHEVROLET C20 SUBURBAN	5.0L V8 307 CID			1955-1957	CHEVROLET ONE-FIFTY SERIES	4.3L V8 4343cc 265 CID
	1968-1972	CHEVROLET C20 SUBURBAN	5.0L V8 5031cc 307 CID			1955-1957	CHEVROLET TRUCK	4.3L V8 4343cc 265 CID
	1968-1972	CHEVROLET C30 PICKUP	5.0L V8 307 CID			1955-1957	CHEVROLET TWO-TEN SERIES	4.3L V8 4343cc 265 CID
	1968-1972	CHEVROLET C30 PICKUP	5.0L V8 5031cc 307 CID			1955-1958	CHEVROLET TRUCK	4.3L L6 4278cc 261 CID
	1968-1972	CHEVROLET CAMARO	5.7L V8 350 CID			1956-1958	CHEVROLET TRUCK	5.3L V8 5272cc 322 CID
	1968-1972	CHEVROLET CHEVELLE	5.0L V8 307 CID			1957	CHEVROLET BEL AIR	4.6L V8 283 CID
	1968-1972	CHEVROLET CHEVELLE	5.0L V8 5031cc 307 CID			1957	CHEVROLET DEL RAY	4.3L V8 4343cc 265 CID
	1968-1972	CHEVROLET CHEVELLE	5.7L V8 5736cc 350 CID			1957	CHEVROLET ONE-FIFTY SERIES	4.6L V8 4638cc 283 CID
	1968-1972	CHEVROLET EL CAMINO	5.0L V8 307 CID			1957	CHEVROLET TWO-TEN SERIES	4.6L V8 4638cc 283 CID
	1968-1972	CHEVROLET EL CAMINO	5.0L V8 5031cc 307 CID			1957-1958	CHEVROLET DEL RAY	4.6L V8 4638cc 283 CID
	1968-1972	CHEVROLET EL CAMINO	5.7L V8 5736cc 350 CID			1957-1958	CHEVROLET TRUCK	4.6L V8 4638cc 283 CID
	1968-1972	CHEVROLET G10 VAN	5.0L V8 307 CID			1957-1961	CHEVROLET CORVETTE	4.6L V8 4638cc 283 CID
	1968-1972	CHEVROLET G20 VAN	5.0L V8 5031cc 307 CID			1957-1967	CHEVROLET BEL AIR	4.6L V8 4638cc 283 CID
	1968-1972	CHEVROLET K10 PICKUP	5.0L V8 307 CID			1958	CHEVROLET BROOKWOOD	4.6L V8 283 CID
	1968-1972	CHEVROLET K10 PICKUP	5.0L V8 5031cc 307 CID			1958	CHEVROLET BROOKWOOD	5.7L V8 5704cc 348 CID
	1968-1972	CHEVROLET K10 SUBURBAN	5.0L V8 307 CID			1958	CHEVROLET DEL RAY	5.7L V8 5704cc 348 CID
	1968-1972	CHEVROLET K10 SUBURBAN	5.0L V8 5031cc 307 CID			1958	CHEVROLET TRUCK	5.7L V8 5704cc 348 CID
	1968-1972	CHEVROLET K20 PICKUP	5.0L V8 307 CID			1958-1961	CHEVROLET BEL AIR	5.7L V8 5704cc 348 CID
	1968-1972	CHEVROLET K20 PICKUP	5.0L V8 5031cc 307 CID			1958-1961	CHEVROLET BISCAYNE	5.7L V8 5704cc 348 CID
	1968-1972	CHEVROLET K20 SUBURBAN	5.0L V8 307 CID			1958-1961	CHEVROLET IMPALA	5.7L V8 5704cc 348 CID
	1968-1972	CHEVROLET K20 SUBURBAN	5.0L V8 5031cc 307 CID			1958-1967	CHEVROLET BISCAYNE	4.6L V8 4638cc 283 CID
	1968-1972	CHEVROLET K30 PICKUP	5.0L V8 307 CID			1958-1967	CHEVROLET IMPALA	4.6L V8 4638cc 283 CID
	1968-1972	CHEVROLET K30 PICKUP	5.0L V8 5031cc 307 CID			1959	CHEVROLET BEL AIR	5.3L V8 5272cc 322 CID
	1968-1974	CHEVROLET CS31003	5.7L V8 5700cc 350 CID			1959-1960	CHEVROLET BEL AIR	4.3L L6 4278cc 261 CID
	1969	AVANTI II	5.7L V8 350 CID			1959-1960	CHEVROLET EL CAMINO	4.6L V8 4638cc 283 CID
	1969	AVANTI II	5.7L V8 5736cc 350 CID			1959-1960	CHEVROLET EL CAMINO	5.7L V8 5704cc 348 CID
	1969	CHECKER DELUXE	5.3L V8 5358cc 327 CID			1959-1961	CHEVROLET BROOKWOOD	4.6L V8 4638cc 283 CID
	1969	CHEVROLET BROOKWOOD	5.0L V8 5031cc 307 CID			1959-1961	CHEVROLET BROOKWOOD	5.7L V8 5704cc 348 CID
	1969	CHEVROLET BROOKWOOD	5.3L V8 5358cc 327 CID			1959-1961	CHEVROLET KINGSWOOD	4.6L V8 4638cc 283 CID
	1969	CHEVROLET KINGSWOOD	5.0L V8 5031cc 307 CID			1959-1961	CHEVROLET KINGSWOOD	5.7L V8 5704cc 348 CID
	1969	CHEVROLET KINGSWOOD	5.3L V8 5358cc 327 CID			1960	CHEVROLET BISCAYNE	4.6L V8 283 CID
	1969-1972	CHEVROLET BEL AIR	5.7L V8 350 CID			1960	CHEVROLET BISCAYNE	5.7L V8 348 CID
	1969-1972	CHEVROLET BEL AIR	5.7L V8 5736cc 350 CID			1960	CHEVROLET TRUCK	4.3L L6 4278cc 261 CID
	1969-1972	CHEVROLET BISCAYNE	5.7L V8 350 CID			1960	CHEVROLET TRUCK	4.6L V8 4638cc 283 CID
	1969-1972	CHEVROLET BISCAYNE	5.7L V8 5736cc 350 CID			1960	CHEVROLET TRUCK	5.7L V8 5704cc 348 CID
	1969-1972	CHEVROLET BLAZER	5.0L V8 307 CID			1960-1961	CHEVROLET C10 PICKUP	5.7L V8 5704cc 348 CID
	1969-1972	CHEVROLET BLAZER	5.0L V8 5031cc 307 CID			1960-1961	CHEVROLET C20 PICKUP	5.7L V8 5704cc 348 CID
	1969-1972	CHEVROLET BLAZER	5.7L V8 350 CID			1960-1961	CHEVROLET C30 PICKUP	5.7L V8 5704cc 348 CID
	1969-1972	CHEVROLET BLAZER	5.7L V8 5736cc 350 CID			1960-1961	CHEVROLET K10 PICKUP	5.7L V8 5704cc 348 CID
	1969-1972	CHEVROLET BROOKWOOD	5.7L V8 350 CID			1960-1961	CHEVROLET K20 PICKUP	5.7L V8 5704cc 348 CID
	1969-1972	CHEVROLET BROOKWOOD	5.7L V8 5736cc 350 CID			1960-1965	CHEVROLET SUBURBAN	5.7L V8 5704cc 348 CID
	1969-1972	CHEVROLET C10 PICKUP	5.7L V8 350 CID			1960-1966	CHEVROLET P30 SERIES	5.7L V8 5704cc 348 CID
	1969-1972	CHEVROLET C10 PICKUP	5.7L V8 5736cc 350 CID			1960-1967	CHEVROLET SUBURBAN	4.6L V8 4638cc 283 CID
	1969-1972	CHEVROLET C10 SUBURBAN	5.7L V8 350 CID			1960-1967	CHEVROLET C10 PICKUP	4.6L V8 4638cc 283 CID
	1969-1972	CHEVROLET C10 SUBURBAN	5.7L V8 5736cc 350 CID			1960-1967	CHEVROLET C20 PICKUP	4.6L V8 4638cc 283 CID
	1969-1972	CHEVROLET C20 PICKUP	5.7L V8 350 CID			1960-1967	CHEVROLET C30 PICKUP	4.6L V8 4638cc 283 CID
	1969-1972	CHEVROLET C20 PICKUP	5.7L V8 5736cc 350 CID			1960-1967	CHEVROLET K10 PICKUP	4.6L V8 4638cc 283 CID
	1969-1972	CHEVROLET C20 SUBURBAN	5.7L V8 350 CID			1960-1967	CHEVROLET K20 PICKUP	4.6L V8 4638cc 283 CID
	1969-1972	CHEVROLET C20 SUBURBAN	5.7L V8 5736cc 350 CID			1961-1962	CHEVROLET C10 PICKUP	4.3L L6 4278cc 261 CID
	1969-1972	CHEVROLET C30 PICKUP	5.7L V8 350 CID			1961-1962	CHEVROLET C20 PICKUP	4.3L L6 4278cc 261 CID
	1969-1972	CHEVROLET C30 PICKUP	5.7L V8 5736cc 350 CID			1961-1962	CHEVROLET C30 PICKUP	4.3L L6 4278cc 261 CID
	1969-1972	CHEVROLET CAMARO	5.0L V8 307 CID			1961-1962	CHEVROLET K10 PICKUP	4.3L L6 4278cc 261 CID
	1969-1972	CHEVROLET CAMARO	5.0L V8 5031cc 307 CID			1961-1962	CHEVROLET K20 PICKUP	4.3L L6 4278cc 261 CID
	1969-1972	CHEVROLET CAPRICE	5.7L V8 350 CID			1961-1962	CHEVROLET P10 SERIES	4.3L L6 4278cc 261 CID
	1969-1972	CHEVROLET CAPRICE	5.7L V8 5736cc 350 CID			1961-1962	CHEVROLET P10 SERIES	4.6L V8 4638cc 283 CID
	1969-1972	CHEVROLET CHEVELLE	5.7L V8 350 CID			1961-1962	CHEVROLET P30 SERIES	4.3L L6 4278cc 261 CID
	1969-1972	CHEVROLET CORVETTE	5.7L V8 350 CID			1961-1962	CHEVROLET P30 SERIES	4.6L V8 4638cc 283 CID
	1969-1972	CHEVROLET CORVETTE	5.7L V8 5736cc 350 CID			1961-1962	CHEVROLET SUBURBAN	4.3L L6 4278cc 261 CID
	1969-1972	CHEVROLET EL CAMINO	5.7L V8 350 CID			1962-1968	CHEVROLET CORVETTE	5.3L V8 5358cc 327 CID
	1969-1972	CHEVROLET IMPALA	5.7L V8 350 CID			1962-1969	CHEVROLET BEL AIR	5.3L V8 5358cc 327 CID

WATER PUMPS



USMW	Years	Application	Engine	USMW	Years	Application	Engine	
<b>US898H</b>	1962-1969	CHEVROLET BISCAYNE	5.3L V8 5358cc 327 CID	<b>US898H</b>	1968-1972	CHEVROLET CHEVELLE	5.0L V8 307 CID	
	1962-1969	CHEVROLET IMPALA	5.3L V8 5358cc 327 CID		1968-1972	CHEVROLET CHEVELLE	5.0L V8 5031cc 307 CID	
	1963-1967	CHEVROLET CHEVY II	4.6L V8 4638cc 283 CID		1968-1972	CHEVROLET CHEVELLE	5.7L V8 5736cc 350 CID	
	1964	CHEVROLET IMPALA	4.6L V8 283 CID		1968-1972	CHEVROLET EL CAMINO	5.0L V8 307 CID	
	1964-1966	CHEVROLET CHEVY II	4.6L V8 283 CID		1968-1972	CHEVROLET EL CAMINO	5.0L V8 5031cc 307 CID	
	1964-1967	CHEVROLET CHEVELLE	4.6L V8 4638cc 283 CID		1968-1972	CHEVROLET EL CAMINO	5.7L V8 5736cc 350 CID	
	1964-1967	CHEVROLET EL CAMINO	4.6L V8 4638cc 283 CID		1968-1972	CHEVROLET G10 VAN	5.0L V8 307 CID	
	1964-1967	CHEVROLET MALIBU	4.6L V8 4638cc 283 CID		1968-1972	CHEVROLET G20 VAN	5.0L V8 5031cc 307 CID	
	1964-1967	CHEVROLET MALIBU	5.3L V8 5358cc 327 CID		1968-1972	CHEVROLET K10 PICKUP	5.0L V8 307 CID	
	1964-1968	CHEVROLET CHEVELLE	5.3L V8 5358cc 327 CID		1968-1972	CHEVROLET K10 PICKUP	5.0L V8 5031cc 307 CID	
	1964-1969	CHEVROLET IMPALA	5.4L V8 327 CID		1968-1972	CHEVROLET K10 SUBURBAN	5.0L V8 307 CID	
	1965	CHEVROLET CHEVELLE	5.4L V8 327 CID		1968-1972	CHEVROLET K10 SUBURBAN	5.0L V8 5031cc 307 CID	
	1965-1966	CHEVROLET CHEVY II	5.4L V8 327 CID		1968-1972	CHEVROLET K20 PICKUP	5.0L V8 307 CID	
	1965-1967	CHECKER MARATHON	4.6L V8 4638cc 283 CID		1968-1972	CHEVROLET K20 PICKUP	5.0L V8 5031cc 307 CID	
	1965-1967	CHEVROLET CHEVELLE	4.6L V8 283 CID		1968-1972	CHEVROLET K20 SUBURBAN	5.0L V8 307 CID	
	1965-1968	CHEVROLET CHEVY II	5.3L V8 5358cc 327 CID		1968-1972	CHEVROLET K20 SUBURBAN	5.0L V8 5031cc 307 CID	
	1965-1969	AVANTI II	5.3L V8 5358cc 327 CID		1968-1972	CHEVROLET K30 PICKUP	5.0L V8 307 CID	
	1965-1969	CHECKER MARATHON	5.3L V8 5358cc 327 CID		1968-1972	CHEVROLET K30 PICKUP	5.0L V8 5031cc 307 CID	
	1966	CHEVROLET SUBURBAN	5.3L V8 5358cc 327 CID		1969	AVANTI II	5.7L V8 350 CID	
	1966-1967	CHEVROLET CAPRICE	4.6L V8 4638cc 283 CID		1969	AVANTI II	5.7L V8 5736cc 350 CID	
	1966-1967	CHEVROLET IMPALA	4.6L V8 283 CID		1969	CHECKER DELUXE	5.3L V8 5358cc 327 CID	
	1966-1969	CHEVROLET C10 PICKUP	5.3L V8 5358cc 327 CID		1969	CHEVROLET BROOKWOOD	5.0L V8 5031cc 307 CID	
	1966-1969	CHEVROLET C20 PICKUP	5.3L V8 5358cc 327 CID		1969	CHEVROLET BROOKWOOD	5.3L V8 5358cc 327 CID	
	1966-1969	CHEVROLET C30 PICKUP	5.3L V8 5358cc 327 CID		1969	CHEVROLET KINGSWOOD	5.0L V8 5031cc 307 CID	
	1966-1969	CHEVROLET CAPRICE	5.3L V8 5358cc 327 CID		1969	CHEVROLET KINGSWOOD	5.3L V8 5358cc 327 CID	
	1966-1969	CHEVROLET EL CAMINO	5.3L V8 5358cc 327 CID		1969-1972	CHEVROLET BEL AIR	5.7L V8 350 CID	
	1966-1969	CHEVROLET K10 PICKUP	5.3L V8 5358cc 327 CID		1969-1972	CHEVROLET BEL AIR	5.7L V8 5736cc 350 CID	
	1966-1969	CHEVROLET K20 PICKUP	5.3L V8 5358cc 327 CID		1969-1972	CHEVROLET BISCAYNE	5.7L V8 350 CID	
	1967	CHEVROLET C10 SUBURBAN	4.6L V8 4638cc 283 CID		1969-1972	CHEVROLET BISCAYNE	5.7L V8 5736cc 350 CID	
	1967	CHEVROLET C20 SUBURBAN	4.6L V8 4638cc 283 CID		1969-1972	CHEVROLET BLAZER	5.0L V8 307 CID	
	1967	CHEVROLET G20 VAN	4.6L V8 4638cc 283 CID		1969-1972	CHEVROLET BLAZER	5.0L V8 5031cc 307 CID	
	1967	CHEVROLET K10 SUBURBAN	4.6L V8 4638cc 283 CID		1969-1972	CHEVROLET BLAZER	5.7L V8 350 CID	
	1967	CHEVROLET K20 PANEL	4.6L V8 283 CID		1969-1972	CHEVROLET BLAZER	5.7L V8 5736cc 350 CID	
	1967	CHEVROLET K20 PANEL	5.4L V8 327 CID		1969-1972	CHEVROLET BROOKWOOD	5.7L V8 350 CID	
	1967	CHEVROLET K20 SUBURBAN	4.6L V8 4638cc 283 CID		1969-1972	CHEVROLET BROOKWOOD	5.7L V8 5736cc 350 CID	
	1967-1968	CHEVROLET CHEVELLE	5.4L V8 327 CID		1969-1972	CHEVROLET C10 PICKUP	5.7L V8 350 CID	
	1967-1969	CHEVROLET C10 SUBURBAN	5.3L V8 5358cc 327 CID		1969-1972	CHEVROLET C10 PICKUP	5.7L V8 5736cc 350 CID	
	1967-1969	CHEVROLET C20 SUBURBAN	5.3L V8 5358cc 327 CID		1969-1972	CHEVROLET C10 SUBURBAN	5.7L V8 350 CID	
	1967-1969	CHEVROLET CAMARO	5.3L V8 5358cc 327 CID		1969-1972	CHEVROLET C10 SUBURBAN	5.7L V8 5736cc 350 CID	
	1967-1969	CHEVROLET K10 SUBURBAN	5.3L V8 5358cc 327 CID		1969-1972	CHEVROLET C20 PICKUP	5.7L V8 350 CID	
	1967-1969	CHEVROLET K20 SUBURBAN	5.3L V8 5358cc 327 CID		1969-1972	CHEVROLET C20 PICKUP	5.7L V8 5736cc 350 CID	
	1967-1972	CHEVROLET CAMARO	5.7L V8 5736cc 350 CID		1969-1972	CHEVROLET C20 SUBURBAN	5.7L V8 350 CID	
	1968	CHECKER MARATHON	5.0L V8 307 CID		1969-1972	CHEVROLET C20 SUBURBAN	5.7L V8 5736cc 350 CID	
	1968	CHECKER MARATHON	5.0L V8 5031cc 307 CID		1969-1972	CHEVROLET C30 PICKUP	5.7L V8 350 CID	
	1968	CHEVROLET BEL AIR	5.0L V8 307 CID		1969-1972	CHEVROLET C30 PICKUP	5.7L V8 5736cc 350 CID	
	1968	CHEVROLET BEL AIR	5.0L V8 5031cc 307 CID		1969-1972	CHEVROLET CAMARO	5.0L V8 307 CID	
	1968	CHEVROLET BISCAYNE	5.0L V8 307 CID		1969-1972	CHEVROLET CAMARO	5.0L V8 5031cc 307 CID	
	1968	CHEVROLET BISCAYNE	5.0L V8 5031cc 307 CID		1969-1972	CHEVROLET CAPRICE	5.7L V8 350 CID	
	1968	CHEVROLET C10 PICKUP	5.4L V8 327 CID		1969-1972	CHEVROLET CAPRICE	5.7L V8 5736cc 350 CID	
	1968	CHEVROLET C10 SUBURBAN	5.4L V8 327 CID		1969-1972	CHEVROLET CHEVELLE	5.7L V8 350 CID	
	1968	CHEVROLET C20 PICKUP	5.4L V8 327 CID		1969-1972	CHEVROLET CORVETTE	5.7L V8 350 CID	
	1968	CHEVROLET C20 SUBURBAN	5.4L V8 327 CID		1969-1972	CHEVROLET CORVETTE	5.7L V8 5736cc 350 CID	
	1968	CHEVROLET C30 PICKUP	5.4L V8 327 CID		1969-1972	CHEVROLET EL CAMINO	5.7L V8 350 CID	
	1968	CHEVROLET CAPRICE	5.0L V8 307 CID		1969-1972	CHEVROLET IMPALA	5.7L V8 350 CID	
	1968	CHEVROLET CHEVY II	5.0L V8 307 CID		1969-1972	CHEVROLET IMPALA	5.7L V8 5736cc 350 CID	
	1968	CHEVROLET CHEVY II	5.0L V8 5031cc 307 CID		1969-1972	CHEVROLET K10 PICKUP	5.7L V8 350 CID	
	1968	CHEVROLET CHEVY II	5.4L V8 327 CID		1969-1972	CHEVROLET K10 PICKUP	5.7L V8 5736cc 350 CID	
	1968	CHEVROLET CHEVY II	5.7L V8 350 CID		1969-1972	CHEVROLET K10 SUBURBAN	5.7L V8 350 CID	
	1968	CHEVROLET CHEVY II	5.7L V8 5736cc 350 CID		1969-1972	CHEVROLET K10 SUBURBAN	5.7L V8 5736cc 350 CID	
	1968	CHEVROLET CORVETTE	5.4L V8 327 CID		1969-1972	CHEVROLET K20 PICKUP	5.7L V8 350 CID	
	1968	CHEVROLET EL CAMINO	5.4L V8 327 CID		1969-1972	CHEVROLET K20 PICKUP	5.7L V8 5736cc 350 CID	
	1968	CHEVROLET IMPALA	5.0L V8 307 CID		1969-1972	CHEVROLET K20 SUBURBAN	5.7L V8 350 CID	
	1968	CHEVROLET K10 PICKUP	5.4L V8 327 CID		1969-1972	CHEVROLET K20 SUBURBAN	5.7L V8 5736cc 350 CID	
	1968	CHEVROLET K10 SUBURBAN	5.4L V8 327 CID		1969-1972	CHEVROLET K30 PICKUP	5.7L V8 350 CID	
	1968	CHEVROLET K20 PICKUP	5.4L V8 327 CID		1969-1972	CHEVROLET K30 PICKUP	5.7L V8 5736cc 350 CID	
	1968	CHEVROLET K20 SUBURBAN	5.4L V8 327 CID		1969-1972	CHEVROLET KINGSWOOD	5.7L V8 350 CID	
	1968	CHEVROLET K30 PICKUP	5.4L V8 327 CID		1969-1972	CHEVROLET KINGSWOOD	5.7L V8 5736cc 350 CID	
	1968-1969	AVANTI II	5.4L V8 327 CID		1970-1972	CHEVROLET G10 VAN	5.7L V8 350 CID	
	1968-1969	CHEVROLET BEL AIR	5.4L V8 327 CID		1970-1972	CHEVROLET G20 VAN	5.7L V8 350 CID	
	1968-1969	CHEVROLET BISCAYNE	5.4L V8 327 CID		1970-1972	CHEVROLET G20 VAN	5.7L V8 5736cc 350 CID	
	1968-1969	CHEVROLET CAMARO	5.4L V8 327 CID		1970-1972	CHEVROLET G30 VAN	5.7L V8 350 CID	
	1968-1969	CHEVROLET CAPRICE	5.0L V8 5031cc 307 CID		1970-1972	CHEVROLET P20 VAN	5.7L V8 350 CID	
	1968-1969	CHEVROLET CAPRICE	5.4L V8 327 CID		1970-1972	CHEVROLET P30 VAN	5.7L V8 350 CID	
	1968-1969	CHEVROLET IMPALA	5.0L V8 5031cc 307 CID		1971-1972	CHEVROLET BROOKWOOD	5.0L V8 5031cc 307 CID	
	1968-1969	CHEVROLET K30 PICKUP	5.3L V8 5358cc 327 CID		1971-1972	CHEVROLET CAPRICE	5.0L V8 5031cc 307 CID	
	1968-1969	CHEVROLET P20 VAN	5.0L V8 307 CID		1971-1972	CHEVROLET IMPALA	5.0L V8 5031cc 307 CID	
	1968-1969	CHEVROLET P30 VAN	5.0L V8 307 CID		1971-1972	CHEVROLET KINGSWOOD	5.0L V8 5031cc 307 CID	
	1968-1970	CHEVROLET G20 VAN	5.0L V8 307 CID		1972	CHEVROLET CAMARO	5.7L V8 5737cc 350 CID	
	1968-1972	CHEVROLET C10 PICKUP	5.0L V8 307 CID		1972	CHEVROLET CORVETTE	5.7L V8 5737cc 350 CID	
	1968-1972	CHEVROLET C10 PICKUP	5.0L V8 5031cc 307 CID		<b>US907</b>	1967-1969	PLYMOUTH BARRACUDA	5.2L V8 5200cc 318 CID
	1968-1972	CHEVROLET C10 SUBURBAN	5.0L V8 307 CID		<b>US919</b>	1958	PLYMOUTH PLAZA	5.2L V8 317 CID
	1968-1972	CHEVROLET C10 SUBURBAN	5.0L V8 5031cc 307 CID		1958	PLYMOUTH PLAZA	5.2L V8 5212cc 318 CID	
	1968-1972	CHEVROLET C20 PICKUP	5.0L V8 307 CID		1958-1959	PLYMOUTH BELVEDERE	5.2L V8 317 CID	
	1968-1972	CHEVROLET C20 PICKUP	5.0L V8 5031cc 307 CID		1958-1959	PLYMOUTH FURY	5.2L V8 317 CID	
	1968-1972	CHEVROLET C20 SUBURBAN	5.0L V8 307 CID		1958-1959	PLYMOUTH SAVOY	5.2L V8 317 CID	
	1968-1972	CHEVROLET C20 SUBURBAN	5.0L V8 5031cc 307 CID		1958-1959	PLYMOUTH SUBURBAN	5.2L V8 317 CID	
	1968-1972	CHEVROLET C30 PICKUP	5.0L V8 307 CID		1958-1961	PLYMOUTH CUSTOM	5.2L V8 5212cc 318 CID	
	1968-1972	CHEVROLET C30 PICKUP	5.0L V8 5031cc 307 CID		1958-1961	PLYMOUTH SUBURBAN	5.2L V8 318 CID	
	1968-1972	CHEVROLET CAMARO	5.7L V8 350 CID		1958-1961	PLYMOUTH SUBURBAN	5.2L V8 5212cc 318 CID	



USMW	Years	Application	Engine	USMW	Years	Application	Engine		
<b>US919</b>	1958-1964	PLYMOUTH SAVOY	5.2L V8 5212cc 318 CID	<b>US919</b>	1968-1969	PLYMOUTH FURY III	5.2L V8 5212cc 318 CID		
	1958-1969	PLYMOUTH BELVEDERE	5.2L V8 5212cc 318 CID		1968-1969	PLYMOUTH SATELLITE	5.2L V8 318 CID		
	1958-1969	PLYMOUTH FURY	5.2L V8 5212cc 318 CID		1968-1969	PLYMOUTH SATELLITE	5.6L V8 5572cc 340 CID		
	1959	PLYMOUTH FURY	5.2L V8 318 CID		1968-1969	PLYMOUTH VALIANT	5.2L V8 318 CID		
	1960	DODGE MATADOR	5.2L V8 5212cc 318 CID		1968-1969	PLYMOUTH VALIANT	5.2L V8 5212cc 318 CID		
	1960	DODGE TRUCK	5.2L V8 5212cc 318 CID		1968-1969	PLYMOUTH VALIANT	5.6L V8 5572cc 340 CID		
	1960-1961	DODGE POLARA	5.2L V8 5212cc 318 CID		1969	DODGE W200 PICKUP	5.2L V8 318 CID		
	1960-1961	DODGE SENECA	5.2L V8 5212cc 318 CID		<b>US926</b>	1968	OLDSMOBILE DELMONT 88	5.7L V8 350 CID	
	1960-1961	PLYMOUTH SAVOY	5.2L V8 318 CID			1968	OLDSMOBILE DELMONT 88	5.7L V8 455 CID	
	1960-1961	PLYMOUTH SPORT WAGON	5.2L V8 5212cc 318 CID			1968-1969	OLDSMOBILE 442	6.6L V8 6555cc 400 CID	
	1960-1962	DODGE DART	5.2L V8 318 CID			1968-1970	OLDSMOBILE 98	7.5L V8 455 CID	
	1960-1962	DODGE DART	5.2L V8 5212cc 318 CID			1968-1970	OLDSMOBILE 442	7.5L V8 7456cc 455 CID	
	1960-1962	DODGE WM300 POWER WAGON	5.2L V8 5212cc 318 CID			1968-1970	OLDSMOBILE CUTLASS	5.7L V8 350 CID	
	1960-1963	PLYMOUTH FLEET SPECIAL	5.2L V8 5212cc 318 CID			1968-1970	OLDSMOBILE DELTA 88	5.7L V8 350 CID	
	1960-1967	DODGE D100 SERIES	5.2L V8 5212cc 318 CID			1968-1970	OLDSMOBILE DELTA 88	7.5L V8 455 CID	
	1960-1967	DODGE D200 SERIES	5.2L V8 5212cc 318 CID			1968-1970	OLDSMOBILE F85	5.7L V8 350 CID	
	1960-1967	DODGE D300 SERIES	5.2L V8 5212cc 318 CID			1968-1970	OLDSMOBILE VISTA CRUISER	5.7L V8 350 CID	
	1960-1967	DODGE W100 SERIES	5.2L V8 5212cc 318 CID			1970	OLDSMOBILE CUTLASS	7.5L V8 455 CID	
	1960-1967	DODGE W200 SERIES	5.2L V8 5212cc 318 CID			1970	OLDSMOBILE F85	7.5L V8 455 CID	
	1960-1967	DODGE W300 SERIES	5.2L V8 5212cc 318 CID			1970	OLDSMOBILE VISTA CRUISER	7.5L V8 455 CID	
	1963-1964	DODGE 330	5.2L V8 5212cc 318 CID			<b>US927</b>	1966	CHEVROLET CHEVELLE	3.2L L6 194 CID
	1963-1964	DODGE 440	5.2L V8 5212cc 318 CID				1966	CHEVROLET EL CAMINO	3.2L L6 3180cc 194 CID
	1963-1969	DODGE POLARA	5.2L V8 5212cc 318 CID				1966	CHEVROLET MALIBU	3.2L L6 3180cc 194 CID
	1964	DODGE 330	4.5L V8 4473cc 273 CID				1966-1967	CHEVROLET EL CAMINO	3.8L L6 3769cc 230 CID
	1964	PLYMOUTH SAVOY	4.5L V8 4473cc 273 CID				1966-1967	CHEVROLET MALIBU	3.8L L6 3769cc 230 CID
	1964-1965	PLYMOUTH FURY	4.5L V8 4473cc 273 CID				1967	CHEVROLET CHEVELLE	3.8L L6 230 CID
	1964-1966	DODGE A100	4.5L V8 4473cc 273 CID				1967	CHEVROLET CHEVELLE	4.1L L6 250 CID
	1964-1967	DODGE A100 TRUCK	4.5L V8 273 CID				1967	CHEVROLET EL CAMINO	4.1L L6 4098cc 250 CID
	1964-1968	PLYMOUTH BARRACUDA	4.5L V8 4473cc 273 CID				1967	CHEVROLET MALIBU	4.1L L6 4098cc 250 CID
	1964-1968	PLYMOUTH BELVEDERE	4.5L V8 4473cc 273 CID				1967	CHEVROLET MALIBU	4.1L L6 4100cc 250 CID
	1964-1969	DODGE DART	4.5L V8 273 CID				1969	CHEVROLET NOVA	3.8L L6 230 CID
	1964-1969	DODGE DART	4.5L V8 4473cc 273 CID				1969	CHEVROLET NOVA	4.1L L6 250 CID
	1964-1969	PLYMOUTH VALIANT	4.5L V8 273 CID		1974		CHEVROLET NOVA	4.1L L6 250 CID	
	1964-1969	PLYMOUTH VALIANT	4.5L V8 4473cc 273 CID		1974		OLDSMOBILE OMEGA	4.1L L6 250 CID	
	1965	PLYMOUTH FURY	4.5L V8 273 CID		1974		PONTIAC FIREBIRD	4.1L L6 250 CID	
	1965	PLYMOUTH FURY II	4.5L V8 273 CID		1974		PONTIAC LEMANS	4.1L L6 250 CID	
	1965	PLYMOUTH FURY III	4.5L V8 273 CID		1974		PONTIAC VENTURA	4.1L L6 250 CID	
	1965-1967	PLYMOUTH BELVEDERE II	4.5L V8 273 CID		<b>US932</b>		1975-1976	FORD ELITE	5.8L V8 351 CID
	1965-1967	PLYMOUTH BELVEDERE II	5.2L V8 318 CID				1975-1976	FORD ELITE	6.6L V8 400 CID
	1965-1968	DODGE CORONET	4.5L V8 273 CID				1975-1976	FORD TORINO	5.8L V8 351 CID
	1965-1968	DODGE CORONET	4.5L V8 4473cc 273 CID				1975-1976	FORD TORINO	6.6L V8 400 CID
	1965-1968	PLYMOUTH SATELLITE	4.5L V8 4473cc 273 CID				1975-1976	MERCURY MONTEGO	5.8L V8 351 CID
	1965-1969	DODGE CORONET	5.2L V8 318 CID				1975-1976	MERCURY MONTEGO	6.6L V8 400 CID
	1965-1969	DODGE CORONET	5.2L V8 5212cc 318 CID				1975-1977	FORD CUSTOM 500	5.8L V8 351 CID
	1965-1969	PLYMOUTH FURY	5.2L V8 318 CID				1975-1977	FORD CUSTOM 500	6.6L V8 400 CID
	1965-1969	PLYMOUTH FURY II	5.2L V8 318 CID			1975-1978	FORD LTD	6.6L V8 400 CID	
	1965-1969	PLYMOUTH FURY III	5.2L V8 318 CID			1975-1978	FORD RANCHERO	6.6L V8 400 CID	
	1965-1969	PLYMOUTH SATELLITE	5.2L V8 5212cc 318 CID			1975-1978	MERCURY COUGAR	6.6L V8 400 CID	
	1966	DODGE POLARA	4.5L V8 4473cc 273 CID			1975-1978	MERCURY MARQUIS	6.6L V8 400 CID	
	1966-1969	DODGE CHARGER	5.2L V8 5212cc 318 CID			1975-1979	FORD LTD	5.8L V8 351 CID	
	1966-1969	PLYMOUTH BARRACUDA	5.2L V8 5212cc 318 CID			1975-1979	FORD RANCHERO	5.8L V8 351 CID	
	1967	DODGE CHARGER	4.5L V8 4473cc 273 CID			1975-1979	MERCURY COUGAR	5.8L V8 351 CID	
	1967	PLYMOUTH VIP	5.2L V8 5212cc 318 CID			1977-1978	FORD LTD II	6.6L V8 400 CID	
	1967-1969	DODGE A100 TRUCK	5.2L V8 318 CID			1977-1978	FORD THUNDERBIRD	6.6L V8 400 CID	
	1967-1969	DODGE CHARGER	5.2L V8 318 CID			1977-1978	MERCURY GRAND MARQUIS	5.8L V8 5800cc 351 CID	
	1968	PLYMOUTH BELVEDERE	4.5L V8 273 CID			1977-1979	FORD F-100	5.8L V8 351 CID	
	1968	PLYMOUTH GTX	5.2L V8 318 CID			1977-1979	FORD F-100	6.6L V8 400 CID	
	1968	PLYMOUTH GTX	5.2L V8 5212cc 318 CID			1977-1979	FORD F-150	5.8L V8 351 CID	
	1968	PLYMOUTH ROAD RUNNER	4.5L V8 273 CID			1977-1979	FORD F-150	6.6L V8 400 CID	
	1968	PLYMOUTH ROAD RUNNER	4.5L V8 4473cc 273 CID			1977-1979	FORD F-250	5.8L V8 351 CID	
	1968	PLYMOUTH ROAD RUNNER	5.2L V8 318 CID			1977-1979	FORD F-350	5.8L V8 351 CID	
	1968	PLYMOUTH ROAD RUNNER	5.2L V8 5212cc 318 CID			1977-1979	FORD LTD II	5.8L V8 351 CID	
	1968	PLYMOUTH ROAD RUNNER	5.6L V8 5572cc 340 CID			1977-1979	FORD THUNDERBIRD	5.8L V8 351 CID	
	1968	PLYMOUTH SATELLITE	4.5L V8 273 CID			1977-1979	LINCOLN CONTINENTAL	6.6L V8 400 CID	
	1968-1969	DODGE D100 PICKUP	5.2L V8 318 CID			1977-1979	LINCOLN MARK V	6.6L V8 400 CID	
	1968-1969	DODGE D100 PICKUP	5.2L V8 5212cc 318 CID			1977-1982	FORD F-250	6.6L V8 400 CID	
	1968-1969	DODGE D200 PICKUP	5.2L V8 318 CID			1977-1982	FORD F-350	6.6L V8 400 CID	
	1968-1969	DODGE D200 PICKUP	5.2L V8 5212cc 318 CID			1978-1979	FORD BRONCO	6.6L V8 400 CID	
	1968-1969	DODGE D300 PICKUP	5.2L V8 318 CID			1978-1979	MERCURY MARQUIS	5.8L V8 351 CID	
	1968-1969	DODGE D300 PICKUP	5.2L V8 5212cc 318 CID			1978-1982	FORD BRONCO	5.8L V8 351 CID	
	1968-1969	DODGE DART	5.2L V8 318 CID			1980	FORD E-250 ECONOLINE	6.6L V8 400 CID	
	1968-1969	DODGE DART	5.2L V8 5212cc 318 CID			1980-1982	FORD E-100 ECONOLINE	5.8L V8 351 CID	
	1968-1969	DODGE DART	5.6L V8 340 CID			1980-1982	FORD E-100 ECONOLINE CLUB WAGON	5.8L V8 351 CID	
	1968-1969	DODGE MONACO	5.2L V8 318 CID			1980-1982	FORD E-150 ECONOLINE	5.8L V8 351 CID	
	1968-1969	DODGE MONACO	5.2L V8 5212cc 318 CID			1980-1982	FORD E-150 ECONOLINE CLUB WAGON	5.8L V8 351 CID	
	1968-1969	DODGE POLARA	5.2L V8 318 CID			1980-1982	FORD E-250 ECONOLINE	5.8L V8 351 CID	
	1968-1969	DODGE W100 PICKUP	5.2L V8 318 CID			1980-1982	FORD E-250 ECONOLINE CLUB WAGON	5.8L V8 351 CID	
	1968-1969	DODGE W100 PICKUP	5.2L V8 5212cc 318 CID			1980-1982	FORD E-250 ECONOLINE CLUB WAGON	5.8L V8 351 CID	
	1968-1969	DODGE W200 PICKUP	5.2L V8 5212cc 318 CID			1980-1982	FORD E-250 ECONOLINE CLUB WAGON	6.6L V8 400 CID	
	1968-1969	DODGE W300 PICKUP	5.2L V8 318 CID			1980-1982	FORD E-350 ECONOLINE	5.8L V8 351 CID	
	1968-1969	DODGE W300 PICKUP	5.2L V8 5212cc 318 CID			1980-1982	FORD E-350 ECONOLINE	6.6L V8 400 CID	
	1968-1969	PLYMOUTH BARRACUDA	5.2L V8 318 CID			1980-1982	FORD E-350 ECONOLINE CLUB WAGON	5.8L V8 351 CID	
	1968-1969	PLYMOUTH BARRACUDA	5.6L V8 340 CID		1980-1982	FORD E-350 ECONOLINE CLUB WAGON	5.8L V8 351 CID		
	1968-1969	PLYMOUTH BARRACUDA	5.6L V8 5572cc 340 CID		1980-1982	FORD E-350 ECONOLINE CLUB WAGON	6.6L V8 400 CID		
	1968-1969	PLYMOUTH BELVEDERE	5.2L V8 318 CID		<b>US953</b>	1968-1974	FORD F350	5.0L V8 5000cc 302 CID	
	1968-1969	PLYMOUTH FURY I	5.2L V8 318 CID			1969-1977	FORD F350	4.7L V8 4700cc 289 CID	
	1968-1969	PLYMOUTH FURY I	5.2L V8 5212cc 318 CID			1969-1978	FORD F100	4.7L V8 4700cc 289 CID	
	1968-1969	PLYMOUTH FURY II	5.2L V8 5212cc 318 CID						
	1968-1969	PLYMOUTH FURY II	5.2L V8 5212cc 318 CID						

WATER PUMPS

USMW	Years	Application	Engine	USMW	Years	Application	Engine	
<b>US953</b>	1970	FORD MAVERICK	5.0L V8 5000cc 302 CID	<b>US953</b>	1980-1986	FORD F-250	5.0L V8 302 CID	
	1970-1976	FORD GALAXIE	5.8L V8 5800cc 351 CID		1980-1987	FORD F-350	5.8L V8 351 CID	
	1971-1977	FORD MAVERICK	4.7L V8 4700cc 289 CID		1981-1982	FORD F-100	4.2L V8 255 CID	
	1973-1974	FORD B100	4.7L V8 4700cc 289 CID		1981-1983	FORD FAIRMONT	5.0L V8 5000cc 302 CID	
	1973-1974	FORD B100	5.0L V8 5000cc 302 CID		1982-1985	FORD B150	3.8L V6 3800cc 232 CID	
	1973-1974	FORD MUSTANG	5.0L V8 5000cc 302 CID		1982-1985	FORD B150	5.0L V8 5000cc 302 CID	
	1974	FORD MUSTANG	5.8L V8 5800cc 351 CID		1983-1987	FORD F350	5.0L V8 5000cc 302 CID	
	1975	FORD E-100 ECONOLINE	5.0L V8 302 CID		1985-1986	FORD B200	5.0L V8 5000cc 302 CID	
	1975	FORD E-150 ECONOLINE	5.0L V8 302 CID		1986	FORD F150	5.0L V8 5000cc 302 CID	
	1975	FORD E-250 ECONOLINE	5.0L V8 302 CID		1986-1987	FORD F200	5.8L V8 5800cc 351 CID	
	1975	FORD E-350 ECONOLINE	5.0L V8 302 CID		1986-1987	FORD F350	5.8L V8 5800cc 351 CID	
	1975	FORD ELITE	5.8L V8 351 CID		1986-1987	FORD P350	5.8L V8 5800cc 351 CID	
	1975	FORD P350	5.0L V8 5000cc 302 CID		<b>US953H</b>	1975	FORD E-100 ECONOLINE	5.0L V8 302 CID
	1975	FORD P400	5.0L V8 5000cc 302 CID			1975	FORD E-150 ECONOLINE	5.0L V8 302 CID
	1975	FORD RANCHERO	5.8L V8 351 CID			1975	FORD E-250 ECONOLINE	5.0L V8 302 CID
	1975-1976	FORD LTD	5.0L V8 5000cc 302 CID			1975	FORD E-350 ECONOLINE	5.0L V8 302 CID
	1975-1976	MERCURY MONTEGO	5.8L V8 351 CID			1975-1976	FORD ELITE	5.8L V8 351 CID
	1975-1977	FORD GRANADA	5.8L V8 351 CID			1975-1976	FORD TORINO	5.8L V8 351 CID
	1975-1977	FORD MAVERICK	5.0L V8 302 CID			1975-1976	MERCURY MONTEGO	5.8L V8 351 CID
	1975-1977	MERCURY COMET	5.0L V8 302 CID	1975-1977		FORD CUSTOM 500	5.8L V8 351 CID	
	1975-1977	MERCURY MONARCH	5.8L V8 351 CID	1975-1977		FORD GRANADA	5.8L V8 351 CID	
	1975-1978	FORD B150	4.7L V8 4700cc 289 CID	1975-1977		FORD MAVERICK	5.0L V8 302 CID	
	1975-1978	FORD B150	5.0L V8 5000cc 302 CID	1975-1977		MERCURY COMET	5.0L V8 302 CID	
	1975-1979	FORD LTD	5.8L V8 351 CID	1975-1977		MERCURY MONARCH	5.8L V8 351 CID	
	1975-1979	MERCURY COUGAR	5.8L V8 351 CID	1975-1979		FORD LTD	5.8L V8 351 CID	
	1975-1980	FORD GRANADA	5.0L V8 302 CID	1975-1979		FORD RANCHERO	5.8L V8 351 CID	
	1975-1980	MERCURY MONARCH	5.0L V8 302 CID	1975-1979		MERCURY COUGAR	5.8L V8 351 CID	
	1975-1983	FORD E-100 ECONOLINE	5.8L V8 351 CID	1975-1980		FORD GRANADA	5.0L V8 302 CID	
	1975-1983	FORD E-100 ECONOLINE CLUB WAGON	5.8L V8 351 CID	1975-1980		MERCURY MONARCH	5.0L V8 302 CID	
	1975-1983	FORD F-100	5.0L V8 302 CID	1975-1983		FORD E-100 ECONOLINE	5.8L V8 351 CID	
	1975-1986	FORD F-150	5.0L V8 302 CID	1975-1983		FORD E-100 ECONOLINE CLUB WAGON	5.8L V8 351 CID	
	1975-1987	FORD E-150 ECONOLINE	5.8L V8 351 CID	1975-1983		FORD F-100	5.0L V8 302 CID	
	1975-1987	FORD E-150 ECONOLINE CLUB WAGON	5.8L V8 351 CID	1975-1986		FORD F-150	5.0L V8 302 CID	
	1975-1987	FORD E-250 ECONOLINE	5.8L V8 351 CID	1975-1987		FORD E-150 ECONOLINE	5.8L V8 351 CID	
	1975-1987	FORD E-250 ECONOLINE CLUB WAGON	5.8L V8 351 CID	1975-1987		FORD E-150 ECONOLINE CLUB WAGON	5.8L V8 351 CID	
	1975-1987	FORD E-350 ECONOLINE	5.8L V8 351 CID	1975-1987		FORD E-250 ECONOLINE	5.8L V8 351 CID	
	1976	FORD F350	5.0L V8 5000cc 302 CID	1975-1987		FORD E-250 ECONOLINE CLUB WAGON	5.8L V8 351 CID	
	1976	FORD TORINO	5.8L V8 351 CID	1975-1987		FORD E-350 ECONOLINE	5.8L V8 351 CID	
	1976-1977	FORD CUSTOM 500	5.8L V8 351 CID	1976		FORD F-350	5.0L V8 302 CID	
	1976-1978	FORD MUSTANG	5.0L V8 5000cc 302 CID	1976-1978		FORD MUSTANG II	5.0L V8 302 CID	
	1976-1978	FORD MUSTANG II	5.0L V8 302 CID	1977		LINCOLN VERSAILLES	5.8L V8 351 CID	
	1977	LINCOLN VERSAILLES	5.8L V8 351 CID	1977-1978		FORD F-250	5.0L V8 302 CID	
	1977-1978	FORD F-250	5.0L V8 302 CID	1977-1979		FORD F-100	5.8L V8 351 CID	
	1977-1978	FORD LTD	5.8L V8 5800cc 351 CID	1977-1979		FORD LTD	5.0L V8 302 CID	
	1977-1978	FORD RANCHERO	5.8L V8 351 CID	1977-1979		FORD LTD II	5.0L V8 302 CID	
	1977-1979	FORD F-100	5.8L V8 351 CID	1977-1979		FORD LTD II	5.8L V8 351 CID	
	1977-1979	FORD LTD	5.0L V8 302 CID	1977-1979		FORD RANCHERO	5.0L V8 302 CID	
	1977-1979	FORD LTD II	5.0L V8 302 CID	1977-1979		FORD THUNDERBIRD	5.0L V8 302 CID	
	1977-1979	FORD LTD II	5.8L V8 351 CID	1977-1979		FORD THUNDERBIRD	5.8L V8 351 CID	
	1977-1979	FORD RANCHERO	5.0L V8 302 CID	1977-1979		MERCURY COUGAR	5.0L V8 302 CID	
	1977-1979	FORD THUNDERBIRD	5.0L V8 302 CID	1977-1980		LINCOLN VERSAILLES	5.0L V8 302 CID	
	1977-1979	FORD THUNDERBIRD	5.8L V8 351 CID	1977-1987		FORD E-350 ECONOLINE CLUB WAGON	5.8L V8 351 CID	
	1977-1979	MERCURY COUGAR	5.0L V8 302 CID	1977-1987		FORD F-150	5.8L V8 351 CID	
	1977-1980	LINCOLN VERSAILLES	5.0L V8 302 CID	1977-1987		FORD F-250	5.8L V8 351 CID	
	1977-1987	FORD E-350 ECONOLINE CLUB WAGON	5.8L V8 351 CID	1978-1979	FORD FAIRMONT	5.0L V8 302 CID		
	1977-1987	FORD F-150	5.8L V8 351 CID	1978-1979	MERCURY MARQUIS	5.8L V8 351 CID		
	1977-1987	FORD F-250	5.8L V8 351 CID	1978-1979	MERCURY ZEPHYR	5.0L V8 302 CID		
	1978	FORD LTD	5.8L V8 5752cc 351 CID	1978-1987	FORD BRONCO	5.8L V8 351 CID		
	1978-1979	FORD FAIRMONT	4.2L V8 4200cc 256 CID	1979	FORD E-350 ECONOLINE	5.0L V8 302 CID		
	1978-1979	FORD FAIRMONT	5.0L V8 302 CID	1979	FORD E-350 ECONOLINE CLUB WAGON	5.0L V8 302 CID		
	1978-1979	MERCURY MARQUIS	5.8L V8 351 CID	1979	MERCURY MARQUIS	5.0L V8 302 CID		
	1978-1979	MERCURY ZEPHYR	5.0L V8 302 CID	1979-1980	FORD E-250 ECONOLINE CLUB WAGON	5.0L V8 302 CID		
	1978-1980	FORD F350	5.0L V8 5000cc 302 CID	1979-1983	FORD E-100 ECONOLINE	5.0L V8 302 CID		
	1978-1987	FORD BRONCO	5.8L V8 351 CID	1979-1983	FORD E-100 ECONOLINE CLUB WAGON	5.0L V8 302 CID		
	1979	FORD B100	4.7L V8 4700cc 289 CID	1979-1986	FORD E-150 ECONOLINE	5.0L V8 302 CID		
	1979	FORD B-100	5.0L V8 302 CID	1979-1986	FORD E-150 ECONOLINE CLUB WAGON	5.0L V8 302 CID		
	1979	FORD E-350 ECONOLINE	5.0L V8 302 CID	1979-1986	FORD E-250 ECONOLINE	5.0L V8 302 CID		
	1979	FORD E-350 ECONOLINE CLUB WAGON	5.0L V8 302 CID	1980	FORD F-350	5.0L V8 302 CID		
	1979	FORD F150	4.7L V8 4700cc 289 CID	1980	MERCURY MONARCH	4.2L V8 255 CID		
	1979	MERCURY MARQUIS	5.0L V8 302 CID	1980-1981	FORD GRANADA	4.2L V8 255 CID		
	1979-1980	FORD E-250 ECONOLINE CLUB WAGON	5.0L V8 302 CID	1980-1982	FORD FAIRMONT	4.2L V8 255 CID		
	1979-1981	FORD B100	5.0L V8 5000cc 302 CID	1980-1982	MERCURY ZEPHYR	4.2L V8 255 CID		
	1979-1983	FORD E-100 ECONOLINE	5.0L V8 302 CID	1980-1986	FORD BRONCO	5.0L V8 302 CID		
	1979-1983	FORD E-100 ECONOLINE CLUB WAGON	5.0L V8 302 CID	1980-1986	FORD F-250	5.0L V8 302 CID		
	1979-1986	FORD E-150 ECONOLINE	5.0L V8 302 CID	1980-1987	FORD F-350	5.8L V8 351 CID		
	1979-1986	FORD E-150 ECONOLINE CLUB WAGON	5.0L V8 302 CID	1981-1982	FORD F-100	4.2L V8 255 CID		
	1979-1986	FORD E-250 ECONOLINE	5.0L V8 302 CID	<b>US960</b>	1975-1977	FORD MAVERICK	4.1L L6 250 CID	
	1979-1986	FORD E-250 ECONOLINE CLUB WAGON	5.0L V8 302 CID		1975-1977	MERCURY COMET	4.1L L6 250 CID	
	1980	FORD F-350	5.0L V8 302 CID		1975-1980	FORD GRANADA	4.1L L6 250 CID	
	1980	MERCURY MONARCH	4.2L V8 255 CID		1975-1980	MERCURY MONARCH	4.1L L6 250 CID	
	1980-1981	FORD GRANADA	4.2L V8 255 CID		<b>US964</b>	1971-1974	FORD PINTO	2.0L L4 1993cc 122 CID
	1980-1982	FORD FAIRMONT	4.2L V8 255 CID			1971-1974	MERCURY CAPRI	2.0L L4 1993cc 122 CID
	1980-1982	MERCURY ZEPHYR	4.2L V8 255 CID	<b>US975</b>	1975	OLDSMOBILE CUSTOM CRUISER	6.6L V8 400 CID	
	1980-1986	FORD BRONCO	5.0L V8 302 CID					

USMW	Years	Application	Engine	USMW	Years	Application	Engine
<b>US975</b>	1975	PONTIAC GRAND AM	5.7L V8 350 CID	<b>US981</b>	1968-1969	CHEVROLET CAPRICE	6.5L V8 396 CID
	1975	PONTIAC GRAND AM	6.6L V8 400 CID		1968-1969	CHEVROLET CAPRICE	7.0L V8 427 CID
	1975	PONTIAC GRAND AM	7.5L V8 455 CID		1968-1969	CHEVROLET CORVETTE	7.0L V8 427 CID
	1975-1976	PONTIAC BONNEVILLE	7.5L V8 455 CID		1968-1969	CHEVROLET K10 PICKUP	6.5L V8 396 CID
	1975-1976	PONTIAC CATALINA	7.5L V8 455 CID		1968-1969	CHEVROLET K10 PICKUP	6.5L V8 6489cc 396 CID
	1975-1976	PONTIAC FIREBIRD	5.7L V8 350 CID		1968-1969	CHEVROLET K10 SUBURBAN	6.5L V8 396 CID
	1975-1976	PONTIAC FIREBIRD	7.5L V8 455 CID		1968-1969	CHEVROLET K10 SUBURBAN	6.5L V8 6489cc 396 CID
	1975-1976	PONTIAC GRAND PRIX	7.5L V8 455 CID		1968-1969	CHEVROLET K20 PICKUP	6.5L V8 396 CID
	1975-1976	PONTIAC GRAND SAFARI	7.5L V8 455 CID		1968-1969	CHEVROLET K20 PICKUP	6.5L V8 6489cc 396 CID
	1975-1976	PONTIAC LEMANS	5.7L V8 350 CID		1968-1969	CHEVROLET K20 SUBURBAN	6.5L V8 6489cc 396 CID
	1975-1977	PONTIAC GRAND PRIX	6.6L V8 400 CID		1968-1969	CHEVROLET K30 PICKUP	6.5L V8 396 CID
	1975-1977	PONTIAC LEMANS	6.6L V8 400 CID		1968-1969	CHEVROLET K30 PICKUP	6.5L V8 6489cc 396 CID
	1975-1978	PONTIAC BONNEVILLE	6.6L V8 400 CID		1968-1969	GMC C15/C1500 PICKUP	6.5L V8 396 CID
	1975-1978	PONTIAC CATALINA	6.6L V8 400 CID		1968-1969	GMC C15/C1500 PICKUP	6.5L V8 6489cc 396 CID
	1975-1978	PONTIAC GRAND SAFARI	6.6L V8 400 CID		1968-1969	GMC C15/C1500 SUBURBAN	6.5L V8 396 CID
	1975-1979	PONTIAC FIREBIRD	6.6L V8 400 CID		1968-1969	GMC C15/C1500 SUBURBAN	6.5L V8 6489cc 396 CID
	1976	PONTIAC GRAND PRIX	5.7L V8 350 CID		1968-1969	GMC C25/C2500 PICKUP	6.5L V8 396 CID
	1976	PONTIAC LEMANS	7.5L V8 455 CID		1968-1969	GMC C25/C2500 PICKUP	6.5L V8 6489cc 396 CID
	1976-1977	PONTIAC CATALINA	5.7L V8 350 CID		1968-1969	GMC C25/C2500 SUBURBAN	6.5L V8 396 CID
	1977	BUICK SKYLARK	4.9L V8 301 CID		1968-1969	GMC C25/C2500 SUBURBAN	6.5L V8 6489cc 396 CID
	1977	PONTIAC FIREBIRD	4.9L V8 301 CID		1968-1969	GMC C35/C3500 PICKUP	6.5L V8 396 CID
	1977	PONTIAC GRAND PRIX	6.6L V8 403 CID		1968-1969	GMC C35/C3500 PICKUP	6.5L V8 6489cc 396 CID
	1977	PONTIAC GRAND SAFARI	4.9L V8 301 CID		1968-1969	GMC K15/K1500 PICKUP	6.5L V8 396 CID
	1977	PONTIAC GRAND SAFARI	5.7L V8 350 CID		1968-1969	GMC K15/K1500 PICKUP	6.5L V8 6489cc 396 CID
	1977	PONTIAC LEMANS	4.9L V8 301 CID		1968-1969	GMC K15/K1500 SUBURBAN	6.5L V8 6489cc 396 CID
	1977	PONTIAC LEMANS	6.6L V8 403 CID		1968-1969	GMC K25/K2500 PICKUP	6.5L V8 396 CID
	1977	PONTIAC VENTURA	4.9L V8 301 CID		1968-1969	GMC K25/K2500 PICKUP	6.5L V8 6489cc 396 CID
	1977-1978	PONTIAC BONNEVILLE	5.7L V8 350 CID		1968-1969	GMC K25/K2500 SUBURBAN	6.5L V8 6489cc 396 CID
	1977-1978	PONTIAC GRAND SAFARI	6.6L V8 403 CID		1968-1969	GMC K35/K3500 PICKUP	6.5L V8 396 CID
	1977-1979	PONTIAC BONNEVILLE	6.6L V8 403 CID		1968-1969	GMC K35/K3500 PICKUP	6.5L V8 6489cc 396 CID
	1977-1979	PONTIAC CATALINA	4.1L L6 250 CID		1968-1970	CHEVROLET EL CAMINO	6.5L V8 396 CID
	1977-1979	PONTIAC CATALINA	6.6L V8 403 CID		1969	CHEVROLET CAMARO	7.0L V8 427 CID
	1977-1979	PONTIAC FIREBIRD	6.6L V8 403 CID		1969	CHEVROLET CAMARO	7.0L V8 6998cc 427 CID
	1977-1980	BUICK LESABRE	4.9L V8 301 CID		1970	CHEVROLET CHEVELLE	6.6L V8 402 CID
	1977-1980	PONTIAC BONNEVILLE	4.9L V8 301 CID		1970	CHEVROLET EL CAMINO	6.6L V8 400 CID
	1977-1980	PONTIAC CATALINA	4.9L V8 301 CID		1970-1971	CHEVROLET CHEVELLE	6.6L V8 400 CID
	1977-1980	PONTIAC GRAND PRIX	4.9L V8 301 CID		1970-1971	CHEVROLET CHEVELLE	6.6L V8 6556cc 400 CID
	1978-1980	PONTIAC GRAND AM	4.9L V8 301 CID		1970-1971	CHEVROLET K30 PICKUP	6.6L V8 402 CID
	1979	OLDSMOBILE DELTA 88	4.9L V8 301 CID		1970-1971	GMC K35/K3500 PICKUP	6.6L V8 402 CID
	1979-1980	BUICK CENTURY	4.9L V8 301 CID		1970-1972	CHEVROLET BEL AIR	6.6L V8 400 CID
	1979-1980	BUICK REGAL	4.9L V8 301 CID		1970-1972	CHEVROLET BEL AIR	6.6L V8 6555cc 400 CID
	1979-1981	PONTIAC FIREBIRD	4.9L V8 301 CID		1970-1972	CHEVROLET BEL AIR	6.6L V8 6556cc 400 CID
	1979-1981	PONTIAC LEMANS	4.9L V8 301 CID		1970-1972	CHEVROLET BEL AIR	6.6L V8 6588cc 402 CID
	1980	BUICK ELECTRA	4.9L V8 301 CID		1970-1972	CHEVROLET BISCAYNE	6.6L V8 400 CID
	1980	BUICK ESTATE WAGON	4.9L V8 301 CID		1970-1972	CHEVROLET BISCAYNE	6.6L V8 6555cc 400 CID
	1980-1981	BUICK CENTURY	4.3L V8 265 CID		1970-1972	CHEVROLET BISCAYNE	6.6L V8 6556cc 400 CID
	1980-1981	BUICK REGAL	4.3L V8 265 CID		1970-1972	CHEVROLET BISCAYNE	6.6L V8 6588cc 402 CID
	1980-1981	PONTIAC BONNEVILLE	4.3L V8 265 CID		1970-1972	CHEVROLET C10 PICKUP	6.6L V8 402 CID
	1980-1981	PONTIAC CATALINA	4.3L V8 265 CID		1970-1972	CHEVROLET C10 PICKUP	6.6L V8 6588cc 402 CID
	1980-1981	PONTIAC GRAND LEMANS	4.3L V8 265 CID		1970-1972	CHEVROLET C10 SUBURBAN	6.6L V8 402 CID
1980-1981	PONTIAC GRAND LEMANS	4.9L V8 301 CID	1970-1972	CHEVROLET C10 SUBURBAN	6.6L V8 6588cc 402 CID		
1980-1981	PONTIAC GRAND PRIX	4.3L V8 265 CID	1970-1972	CHEVROLET C20 PICKUP	6.6L V8 402 CID		
1980-1981	PONTIAC LEMANS	4.3L V8 265 CID	1970-1972	CHEVROLET C20 PICKUP	6.6L V8 6588cc 402 CID		
1981	PONTIAC FIREBIRD	4.3L V8 265 CID	1970-1972	CHEVROLET C20 SUBURBAN	6.6L V8 402 CID		
<b>US981</b>	1966-1967	CHEVROLET MALIBU	6.5L V8 6489cc 396 CID	1970-1972	CHEVROLET C20 SUBURBAN	6.6L V8 6588cc 402 CID	
	1966-1969	CHEVROLET BEL AIR	6.5L V8 6489cc 396 CID	1970-1972	CHEVROLET C30 PICKUP	6.6L V8 402 CID	
	1966-1969	CHEVROLET BEL AIR	7.0L V8 6998cc 427 CID	1970-1972	CHEVROLET C30 PICKUP	6.6L V8 6588cc 402 CID	
	1966-1969	CHEVROLET BISCAYNE	6.5L V8 6489cc 396 CID	1970-1972	CHEVROLET CAMARO	6.6L V8 402 CID	
	1966-1969	CHEVROLET BISCAYNE	7.0L V8 6998cc 427 CID	1970-1972	CHEVROLET CAMARO	6.6L V8 6588cc 402 CID	
	1966-1969	CHEVROLET CAPRICE	6.5L V8 6489cc 396 CID	1970-1972	CHEVROLET CAPRICE	6.6L V8 400 CID	
	1966-1969	CHEVROLET CAPRICE	7.0L V8 6998cc 427 CID	1970-1972	CHEVROLET CAPRICE	6.6L V8 6555cc 400 CID	
	1966-1969	CHEVROLET CHEVELLE	6.5L V8 6489cc 396 CID	1970-1972	CHEVROLET CAPRICE	6.6L V8 6556cc 400 CID	
	1966-1969	CHEVROLET CORVETTE	7.0L V8 6998cc 427 CID	1970-1972	CHEVROLET CAPRICE	6.6L V8 6588cc 402 CID	
	1966-1969	CHEVROLET EL CAMINO	6.5L V8 6489cc 396 CID	1970-1972	CHEVROLET CHEVELLE	6.6L V8 6555cc 400 CID	
	1966-1969	CHEVROLET IMPALA	6.5L V8 396 CID	1970-1972	CHEVROLET CHEVELLE	6.6L V8 6588cc 402 CID	
	1966-1969	CHEVROLET IMPALA	6.5L V8 6489cc 396 CID	1970-1972	CHEVROLET EL CAMINO	6.6L V8 6555cc 400 CID	
	1966-1969	CHEVROLET IMPALA	7.0L V8 427 CID	1970-1972	CHEVROLET EL CAMINO	6.6L V8 6588cc 402 CID	
	1966-1969	CHEVROLET IMPALA	7.0L V8 6998cc 427 CID	1970-1972	CHEVROLET IMPALA	6.6L V8 400 CID	
	1966-1970	CHEVROLET CHEVELLE	6.5L V8 396 CID	1970-1972	CHEVROLET IMPALA	6.6L V8 6555cc 400 CID	
	1967-1969	CHEVROLET CAMARO	6.5L V8 6489cc 396 CID	1970-1972	CHEVROLET IMPALA	6.6L V8 6556cc 400 CID	
	1968	CHEVROLET CAMARO	6.5L V8 396 CID	1970-1972	CHEVROLET IMPALA	6.6L V8 6588cc 402 CID	
	1968	CHEVROLET CHEVY II	6.5L V8 396 CID	1970-1972	CHEVROLET K10 PICKUP	6.6L V8 6588cc 402 CID	
	1968	CHEVROLET CHEVY II	6.5L V8 6489cc 396 CID	1970-1972	CHEVROLET K10 SUBURBAN	6.6L V8 402 CID	
	1968	GMC K15/K1500 SUBURBAN	6.5L V8 396 CID	1970-1972	CHEVROLET K10 SUBURBAN	6.6L V8 6588cc 402 CID	
	1968	GMC K25/K2500 SUBURBAN	6.5L V8 396 CID	1970-1972	CHEVROLET K20 PICKUP	6.6L V8 6588cc 402 CID	
	1968-1969	CHEVROLET BEL AIR	6.5L V8 396 CID	1970-1972	CHEVROLET K20 SUBURBAN	6.6L V8 6588cc 402 CID	
	1968-1969	CHEVROLET BEL AIR	7.0L V8 427 CID	1970-1972	CHEVROLET K30 PICKUP	6.6L V8 6588cc 402 CID	
	1968-1969	CHEVROLET BISCAYNE	6.5L V8 396 CID	1970-1972	GMC C15/C1500 PICKUP	6.6L V8 402 CID	
	1968-1969	CHEVROLET BISCAYNE	7.0L V8 427 CID	1970-1972	GMC C15/C1500 PICKUP	6.6L V8 6588cc 402 CID	
	1968-1969	CHEVROLET C10 PICKUP	6.5L V8 396 CID	1970-1972	GMC C15/C1500 SUBURBAN	6.6L V8 402 CID	
	1968-1969	CHEVROLET C10 PICKUP	6.5L V8 6489cc 396 CID	1970-1972	GMC C15/C1500 SUBURBAN	6.6L V8 6588cc 402 CID	
	1968-1969	CHEVROLET C10 SUBURBAN	6.5L V8 396 CID	1970-1972	GMC C25/C2500 PICKUP	6.6L V8 402 CID	
	1968-1969	CHEVROLET C10 SUBURBAN	6.5L V8 6489cc 396 CID	1970-1972	GMC C25/C2500 PICKUP	6.6L V8 6588cc 402 CID	
	1968-1969	CHEVROLET C20 PICKUP	6.5L V8 396 CID	1970-1972	GMC C25/C2500 SUBURBAN	6.6L V8 402 CID	
1968-1969	CHEVROLET C20 PICKUP	6.5L V8 6489cc 396 CID	1970-1972	GMC C25/C2500 SUBURBAN	6.6L V8 6588cc 402 CID		
1968-1969	CHEVROLET C20 SUBURBAN	6.5L V8 396 CID	1970-1972	GMC C35/C3500 PICKUP	6.6L V8 402 CID		
1968-1969	CHEVROLET C20 SUBURBAN	6.5L V8 6489cc 396 CID	1970-1972	GMC C35/C3500 PICKUP	6.6L V8 6588cc 402 CID		
1968-1969	CHEVROLET C30 PICKUP	6.5L V8 396 CID	1970-1972	GMC K15/K1500 PICKUP	6.6L V8 6588cc 402 CID		
1968-1969	CHEVROLET C30 PICKUP	6.5L V8 6489cc 396 CID	1970-1972	GMC K15/K1500 SUBURBAN	6.6L V8 402 CID		

WATER PUMPS



USMW	Years	Application	Engine	USMW	Years	Application	Engine		
<b>US981</b>	1970-1972	<b>GMC K15/K1500 SUBURBAN</b>	6.6L V8 6588cc 402 CID	<b>US1002H</b>	1987-1988	<b>CHEVROLET R20 SUBURBAN</b>	7.4L V8 454 CID		
	1970-1972	<b>GMC K25/K2500 PICKUP</b>	6.6L V8 6588cc 402 CID		1987-1988	<b>CHEVROLET R30</b>	7.4L V8 454 CID		
	1970-1972	<b>GMC K25/K2500 SUBURBAN</b>	6.6L V8 6588cc 402 CID		1987-1988	<b>CHEVROLET V20 SUBURBAN</b>	7.4L V8 454 CID		
	1970-1972	<b>GMC K35/K3500 PICKUP</b>	6.6L V8 6588cc 402 CID		1987-1988	<b>CHEVROLET V30</b>	7.4L V8 454 CID		
	1971-1972	<b>CHEVROLET BEL AIR</b>	6.6L V8 402 CID		1987-1988	<b>GMC R2500 SUBURBAN</b>	7.4L V8 454 CID		
	1971-1972	<b>CHEVROLET BISCAYNE</b>	6.6L V8 402 CID		1987-1989	<b>GMC R2500</b>	7.4L V8 454 CID		
	1971-1972	<b>CHEVROLET CAPRICE</b>	6.6L V8 402 CID		1987-1991	<b>GMC R3500</b>	7.4L V8 454 CID		
	1971-1972	<b>CHEVROLET EL CAMINO</b>	6.6L V8 402 CID		1987-1991	<b>GMC V3500</b>	7.4L V8 454 CID		
	1971-1972	<b>CHEVROLET IMPALA</b>	6.6L V8 402 CID		1989	<b>CHEVROLET R2500</b>	7.4L V8 454 CID		
	1971-1972	<b>GMC P15/P1500 VAN</b>	6.6L V8 400 CID		1989-1991	<b>CHEVROLET R3500</b>	7.4L V8 454 CID		
	1971-1972	<b>GMC P25/P2500 VAN</b>	6.6L V8 400 CID		1989-1991	<b>CHEVROLET V3500</b>	7.4L V8 454 CID		
	1971-1972	<b>GMC P35/P3500 VAN</b>	6.6L V8 400 CID		1990	<b>CHEVROLET V2500 SUBURBAN</b>	7.4L V8 454 CID		
	1972	<b>CHEVROLET CHEVELLE</b>	6.6L V8 402 CID		<b>US1006</b>	1971-1974	<b>TOYOTA COROLLA</b>	1.2L L4 1166cc 71 CID	
	1972	<b>CHEVROLET P30 VAN</b>	6.6L V8 402 CID		<b>US1010</b>	1971-1973	<b>PLYMOUTH CRICKET</b>	1.5L L4 1498cc	
	<b>US984</b>	1976-1982	<b>CHEVROLET CORVETTE</b>		5.7L V8 350 CID	<b>US1012</b>	1975-1977	<b>DODGE COLT</b>	1.6L L4 1597cc 98 CID
	1980	<b>CHEVROLET CORVETTE</b>	5.0L V8 305 CID		1976-1977	<b>PLYMOUTH ARROW</b>	1.6L L4 1597cc 98 CID		
	<b>US984H</b>	1976-1982	<b>CHEVROLET CORVETTE</b>		5.7L V8 350 CID	1976-1977	<b>PLYMOUTH COLT</b>	1.6L L4 1597cc 98 CID	
	1980	<b>CHEVROLET CORVETTE</b>	5.0L V8 305 CID		1975	<b>BUICK APOLLO</b>	5.7L V8 350 CID		
	<b>US986</b>	1968-1973	<b>AMERICAN MOTORS JAVELIN</b>		4.6L L6 4600cc 282 CID	1975-1976	<b>BUICK CENTURY</b>	5.7L V8 350 CID	
1971-1973		<b>AMERICAN MOTORS JAVELIN</b>	4.2L L6 4200cc 258 CID	1975-1976	<b>BUICK LESABRE</b>	5.7L V8 350 CID			
1973-1974		<b>AMERICAN MOTORS AMERICAN</b>	4.2L L6 4200cc 258 CID	1975-1976	<b>BUICK REGAL</b>	5.7L V8 350 CID			
1973-1974		<b>AMERICAN MOTORS CLASSIC</b>	4.2L L6 4200cc 258 CID	1975-1976	<b>BUICK SKYLARK</b>	5.7L V8 350 CID			
1973-1974		<b>AMERICAN MOTORS CLASSIC</b>	4.6L L6 4600cc 282 CID	1975-1976	<b>OLDSMOBILE STARFIRE</b>	3.8L V6 231 CID			
1973-1974		<b>AMERICAN MOTORS GREMLIN</b>	4.2L L6 4200cc 258 CID	1975-1976	<b>PONTIAC VENTURA</b>	5.7L V8 350 CID			
1974		<b>AMERICAN MOTORS AMERICAN</b>	3.8L L6 3800cc 232 CID	1975-1977	<b>BUICK CENTURY</b>	3.8L V6 231 CID			
1974		<b>AMERICAN MOTORS CLASSIC</b>	3.8L L6 3800cc 232 CID	1975-1977	<b>BUICK REGAL</b>	3.8L V6 231 CID			
1974		<b>AMERICAN MOTORS GREMLIN</b>	4.2L L6 4228cc 258 CID	1975-1977	<b>BUICK SKYHAWK</b>	3.8L V6 231 CID			
1974		<b>AMERICAN MOTORS GREMLIN</b>	4.2L L6 4229cc 258 CID	1975-1977	<b>BUICK SKYLARK</b>	3.8L V6 231 CID			
<b>US1002</b>		1975	<b>CHEVROLET BEL AIR</b>	7.4L V8 454 CID	1976	<b>PONTIAC SUNBIRD</b>	3.8L V6 231 CID		
1975		<b>CHEVROLET MALIBU</b>	7.4L V8 454 CID	1976-1977	<b>BUICK LESABRE</b>	3.8L V6 231 CID			
1975		<b>CHEVROLET MONTE CARLO</b>	7.4L V8 454 CID	1977	<b>OLDSMOBILE CUTLASS</b>	3.8L V6 231 CID			
1975-1976	<b>CHEVROLET CAPRICE</b>	7.4L V8 454 CID	1977	<b>OLDSMOBILE DELTA 88</b>	3.8L V6 231 CID				
1975-1976	<b>CHEVROLET IMPALA</b>	7.4L V8 454 CID	1977	<b>OLDSMOBILE OMEGA</b>	3.8L V6 231 CID				
1975-1980	<b>CHEVROLET C10</b>	7.4L V8 454 CID	1977	<b>PONTIAC FIREBIRD</b>	3.8L V6 231 CID				
1975-1980	<b>CHEVROLET C10 SUBURBAN</b>	7.4L V8 454 CID	1977	<b>PONTIAC LEMANS</b>	3.8L V6 231 CID				
1975-1986	<b>CHEVROLET C20</b>	7.4L V8 454 CID	1977	<b>PONTIAC PHOENIX</b>	3.8L V6 231 CID				
1975-1986	<b>CHEVROLET C20 SUBURBAN</b>	7.4L V8 454 CID	1977	<b>PONTIAC VENTURA</b>	3.8L V6 231 CID				
1975-1986	<b>CHEVROLET C30</b>	7.4L V8 454 CID	1977-1979	<b>BUICK RIVIERA</b>	5.7L V8 350 CID				
1975-1999	<b>CHEVROLET P30</b>	7.4L V8 454 CID	1977-1980	<b>BUICK ELECTRA</b>	5.7L V8 350 CID				
1980	<b>CHEVROLET K10</b>	7.4L V8 454 CID	1977-1980	<b>OLDSMOBILE STARFIRE</b>	3.8L V6 3800cc 231 CID				
1980	<b>CHEVROLET K20</b>	7.4L V8 454 CID	1977-1980	<b>PONTIAC SUNBIRD</b>	3.8L V6 3800cc 231 CID				
1980	<b>GMC C1500</b>	7.4L V8 454 CID	1977-1985	<b>BUICK LESABRE</b>	3.8L V6 3800cc 231 CID				
1980	<b>GMC C1500 SUBURBAN</b>	7.4L V8 454 CID	1977-1985	<b>OLDSMOBILE DELTA 88</b>	3.8L V6 3800cc 231 CID				
1980	<b>GMC K1500</b>	7.4L V8 454 CID	1978	<b>BUICK SKYLARK</b>	3.8L V6 3800cc 231 CID				
1980-1986	<b>CHEVROLET K30</b>	7.4L V8 454 CID	1978-1979	<b>BUICK CENTURY</b>	3.2L V6 196 CID				
1980-1986	<b>GMC C2500</b>	7.4L V8 454 CID	1978-1979	<b>BUICK REGAL</b>	3.2L V6 196 CID				
1980-1986	<b>GMC C2500 SUBURBAN</b>	7.4L V8 454 CID	1978-1979	<b>CHEVROLET MONZA</b>	3.2L V6 196 CID				
1980-1986	<b>GMC C3500</b>	7.4L V8 454 CID	1978-1979	<b>OLDSMOBILE OMEGA</b>	3.8L V6 3800cc 231 CID				
1980-1986	<b>GMC K3500</b>	7.4L V8 454 CID	1978-1979	<b>PONTIAC PHOENIX</b>	3.8L V6 3800cc 231 CID				
1980-1999	<b>GMC P3500</b>	7.4L V8 454 CID	1978-1980	<b>BUICK SKYHAWK</b>	3.8L V6 3800cc 231 CID				
1985	<b>CHEVROLET K20 SUBURBAN</b>	7.4L V8 454 CID	1978-1980	<b>CHEVROLET MONZA</b>	3.8L V6 3800cc 231 CID				
1987-1988	<b>CHEVROLET R20 SUBURBAN</b>	7.4L V8 454 CID	1978-1980	<b>OLDSMOBILE CUTLASS SALON</b>	3.8L V6 3800cc 231 CID				
1987-1988	<b>CHEVROLET R20 SUBURBAN</b>	7.4L V8 454 CID	1978-1980	<b>PONTIAC CATALINA</b>	5.7L V8 350 CID				
1987-1988	<b>CHEVROLET R30</b>	7.4L V8 454 CID	1978-1981	<b>BUICK CENTURY</b>	3.8L V6 3800cc 231 CID				
1987-1988	<b>CHEVROLET V20 SUBURBAN</b>	7.4L V8 454 CID	1978-1981	<b>PONTIAC CATALINA</b>	3.8L V6 3800cc 231 CID				
1987-1988	<b>CHEVROLET V30</b>	7.4L V8 454 CID	1978-1981	<b>PONTIAC FIREBIRD</b>	3.8L V6 3800cc 231 CID				
1987-1988	<b>GMC R2500 SUBURBAN</b>	7.4L V8 454 CID	1978-1981	<b>PONTIAC LEMANS</b>	3.8L V6 3800cc 231 CID				
1987-1989	<b>GMC R2500</b>	7.4L V8 454 CID	1978-1983	<b>CHEVROLET MALIBU</b>	3.8L V6 3800cc 231 CID				
1987-1991	<b>GMC R3500</b>	7.4L V8 454 CID	1978-1984	<b>CHEVROLET EL CAMINO</b>	3.8L V6 3800cc 231 CID				
1987-1991	<b>GMC V3500</b>	7.4L V8 454 CID	1978-1984	<b>CHEVROLET MONTE CARLO</b>	3.8L V6 3800cc 231 CID				
1989	<b>CHEVROLET R2500</b>	7.4L V8 454 CID	1978-1984	<b>OLDSMOBILE CUTLASS CALAIS</b>	3.8L V6 3800cc 231 CID				
1989-1991	<b>CHEVROLET R3500</b>	7.4L V8 454 CID	1978-1987	<b>BUICK REGAL</b>	3.8L V6 3800cc 231 CID				
1989-1991	<b>CHEVROLET V3500</b>	7.4L V8 454 CID	1978-1987	<b>PONTIAC GRAND PRIX</b>	3.8L V6 3800cc 231 CID				
1990	<b>CHEVROLET V2500 SUBURBAN</b>	7.4L V8 454 CID	1979	<b>BUICK REGAL</b>	3.8L V6 231 CID				
<b>US1002H</b>	1975	<b>CHEVROLET BEL AIR</b>	7.4L V8 454 CID	1979	<b>CHEVROLET EL CAMINO</b>	3.8L V6 231 CID			
1975	<b>CHEVROLET MALIBU</b>	7.4L V8 454 CID	1979	<b>CHEVROLET MALIBU</b>	3.8L V6 231 CID				
1975	<b>CHEVROLET MONTE CARLO</b>	7.4L V8 454 CID	1979	<b>CHEVROLET MONTE CARLO</b>	3.8L V6 231 CID				
1975-1976	<b>CHEVROLET CAPRICE</b>	7.4L V8 454 CID	1979	<b>CHEVROLET MONZA</b>	3.8L V6 231 CID				
1975-1976	<b>CHEVROLET IMPALA</b>	7.4L V8 454 CID	1979	<b>OLDSMOBILE CUTLASS CALAIS</b>	3.8L V6 231 CID				
1975-1979	<b>CHEVROLET P30</b>	7.4L V8 454 CID	1979	<b>OLDSMOBILE CUTLASS SALON</b>	3.8L V6 231 CID				
1975-1980	<b>CHEVROLET C10</b>	7.4L V8 454 CID	1979	<b>PONTIAC GRAND AM</b>	3.8L V6 3800cc 231 CID				
1975-1980	<b>CHEVROLET C10 SUBURBAN</b>	7.4L V8 454 CID	1979	<b>PONTIAC GRAND PRIX</b>	3.8L V6 231 CID				
1975-1986	<b>CHEVROLET C20</b>	7.4L V8 454 CID	1979	<b>PONTIAC LEMANS</b>	3.8L V6 231 CID				
1975-1986	<b>CHEVROLET C20 SUBURBAN</b>	7.4L V8 454 CID	1979-1980	<b>BUICK LESABRE</b>	5.7L V8 350 CID				
1975-1986	<b>CHEVROLET C30</b>	7.4L V8 454 CID	1979-1980	<b>PONTIAC BONNEVILLE</b>	5.7L V8 350 CID				
1980	<b>CHEVROLET K10</b>	7.4L V8 454 CID	1979-1985	<b>BUICK RIVIERA</b>	3.8L V6 3800cc 231 CID				
1980	<b>CHEVROLET K20</b>	7.4L V8 454 CID	1980	<b>BUICK ESTATE WAGON</b>	5.7L V8 350 CID				
1980	<b>GMC C1500</b>	7.4L V8 454 CID	1980-1981	<b>CHEVROLET CAMARO</b>	3.8L V6 3800cc 231 CID				
1980	<b>GMC C1500 SUBURBAN</b>	7.4L V8 454 CID	1980-1981	<b>OLDSMOBILE CUTLASS</b>	3.8L V6 3800cc 231 CID				
1980	<b>GMC K1500</b>	7.4L V8 454 CID	1980-1981	<b>PONTIAC GRAND LEMANS</b>	3.8L V6 3800cc 231 CID				
1980-1986	<b>CHEVROLET K30</b>	7.4L V8 454 CID	1980-1982	<b>CADILLAC DEVILLE</b>	4.1L V6 252 CID				
1980-1986	<b>GMC C2500</b>	7.4L V8 454 CID	1980-1982	<b>CADILLAC FLEETWOOD</b>	4.1L V6 252 CID				
1980-1986	<b>GMC C2500 SUBURBAN</b>	7.4L V8 454 CID	1980-1982	<b>OLDSMOBILE CUTLASS CRUISER</b>	3.8L V6 3800cc 231 CID				
1980-1986	<b>GMC C3500</b>	7.4L V8 454 CID	1980-1984	<b>BUICK ELECTRA</b>	4.1L V6 252 CID				
1980-1986	<b>GMC K3500</b>	7.4L V8 454 CID	1980-1984	<b>BUICK LESABRE</b>	4.1L V6 252 CID				
1985	<b>CHEVROLET K20 SUBURBAN</b>	7.4L V8 454 CID	1980-1984	<b>CHEVROLET CAPRICE</b>	3.8L V6 3800cc 231 CID				
1985-1999	<b>CHEVROLET P30</b>	7.4L V8 454 CID	1980-1984	<b>CHEVROLET IMPALA</b>	3.8L V6 3800cc 231 CID				
1985-1999	<b>GMC P3500</b>	7.4L V8 454 CID	1980-1984	<b>GMC CABALLERO</b>	3.8L V6 3800cc 231 CID				
1987-1988	<b>CHEVROLET R20</b>	7.4L V8 454 CID	1980-1986	<b>PONTIAC BONNEVILLE</b>	3.8L V6 3800cc 231 CID				

USMW	Years	Application	Engine	USMW	Years	Application	Engine	
<b>US1018</b>	1980-1987	<b>OLDSMOBILE CUTLASS SUPREME</b>	3.8L V6 3800cc 231 CID	<b>US1018H</b>	1982	<b>PONTIAC BONNEVILLE</b>	4.1L V6 252 CID	
	1981-1982	<b>CADILLAC ELDORADO</b>	4.1L V6 252 CID		1982	<b>PONTIAC GRAND PRIX</b>	4.1L V6 252 CID	
	1981-1982	<b>CADILLAC SEVILLE</b>	4.1L V6 252 CID		1982-1984	<b>BUICK REGAL</b>	4.1L V6 252 CID	
	1981-1983	<b>OLDSMOBILE 98</b>	4.1L V6 252 CID		1984	<b>PONTIAC PARISIENNE</b>	3.8L V6 3800cc 231 CID	
	1981-1984	<b>BUICK RIVIERA</b>	4.1L V6 252 CID		1985-1987	<b>OLDSMOBILE CUTLASS SALON</b>	3.8L V6 3800cc 231 CID	
	1981-1984	<b>OLDSMOBILE TORONADO</b>	4.1L V6 252 CID		1989	<b>PONTIAC FIREBIRD</b>	3.8L V6 3800cc 231 CID	
	1982	<b>PONTIAC BONNEVILLE</b>	4.1L V6 252 CID		<b>US1021</b>	1965	<b>JEEP J162</b>	4.2L L6 4200cc 258 CID
	1982	<b>PONTIAC GRAND PRIX</b>	4.1L V6 252 CID			1965	<b>JEEP J264D</b>	4.2L L6 4200cc 258 CID
	1982-1984	<b>BUICK REGAL</b>	4.1L V6 252 CID			1965-1971	<b>JEEP CJ5D</b>	3.8L L6 3800cc 232 CID
	1984	<b>PONTIAC PARISIENNE</b>	3.8L V6 3800cc 231 CID			1965-1971	<b>JEEP CJ5D</b>	4.2L L6 4200cc 258 CID
1985-1987	<b>OLDSMOBILE CUTLASS SALON</b>	3.8L V6 3800cc 231 CID	1965-1971	<b>JEEP CJ5S</b>		3.8L L6 3800cc 232 CID		
1989	<b>PONTIAC FIREBIRD</b>	3.8L V6 3800cc 231 CID	1965-1971	<b>JEEP CJ5S</b>		4.2L L6 4200cc 258 CID		
<b>US1018H</b>	1975	<b>BUICK APOLLO</b>	5.7L V8 350 CID	1965-1972		<b>JEEP J164</b>	4.2L L6 4200cc 258 CID	
	1975-1976	<b>OLDSMOBILE STARFIRE</b>	3.8L V6 231 CID	1965-1972		<b>JEEP J164V</b>	4.2L L6 4200cc 258 CID	
	1975-1976	<b>PONTIAC VENTURA</b>	5.7L V8 350 CID	1965-1972		<b>JEEP J364R</b>	4.2L L6 4200cc 258 CID	
	1975-1977	<b>BUICK CENTURY</b>	3.8L V6 231 CID	1965-1974		<b>JEEP CJ7</b>	3.8L L6 3800cc 232 CID	
	1975-1977	<b>BUICK REGAL</b>	3.8L V6 231 CID	1965-1974	<b>JEEP CJ7</b>	4.2L L6 4200cc 258 CID		
	1975-1977	<b>BUICK REGAL</b>	5.7L V8 350 CID	1967	<b>JEEP J264D</b>	3.8L L6 3800cc 232 CID		
	1975-1977	<b>BUICK SKYHAWK</b>	3.8L V6 231 CID	1967	<b>JEEP J264D</b>	4.2L L6 4200cc 258 CID		
	1975-1977	<b>BUICK SKYLARK</b>	3.8L V6 231 CID	1967-1972	<b>JEEP J164</b>	3.8L L6 3800cc 232 CID		
	1975-1978	<b>BUICK CENTURY</b>	5.7L V8 350 CID	1967-1972	<b>JEEP J164V</b>	3.8L L6 3800cc 232 CID		
	1975-1978	<b>BUICK SKYLARK</b>	5.7L V8 350 CID	1967-1972	<b>JEEP J364R</b>	3.8L L6 3800cc 232 CID		
1975-1980	<b>BUICK LESABRE</b>	5.7L V8 350 CID	1968-1969	<b>JEEP J162</b>	3.8L L6 3800cc 232 CID			
1976	<b>PONTIAC SUNBIRD</b>	3.8L V6 231 CID	1968-1969	<b>JEEP J162</b>	4.2L L6 4200cc 258 CID			
1976-1977	<b>BUICK LESABRE</b>	3.8L V6 231 CID	1968-1969	<b>JEEP J262S</b>	3.8L L6 3800cc 232 CID			
1977	<b>OLDSMOBILE CUTLASS</b>	3.8L V6 231 CID	1968-1969	<b>JEEP J262S</b>	4.2L L6 4200cc 258 CID			
1977	<b>OLDSMOBILE DELTA 88</b>	3.8L V6 231 CID	1971	<b>JEEP J262S</b>	3.8L L6 3800cc 232 CID			
1977	<b>OLDSMOBILE OMEGA</b>	3.8L V6 231 CID	1971	<b>JEEP J262S</b>	4.2L L6 4200cc 258 CID			
1977	<b>PONTIAC FIREBIRD</b>	3.8L V6 231 CID	1973	<b>JEEP CJ7</b>	4.6L L6 4600cc 282 CID			
1977	<b>PONTIAC LEMANS</b>	3.8L V6 231 CID	<b>US1028</b>	1965-1974	<b>FORD F350</b>	4.7L V8 4700cc 289 CID		
1977	<b>PONTIAC PHOENIX</b>	3.8L V6 231 CID		1965-1978	<b>FORD F100</b>	4.7L V8 4700cc 289 CID		
1977	<b>PONTIAC VENTURA</b>	3.8L V6 231 CID		1967-1968	<b>FORD F350</b>	5.0L V8 5000cc 302 CID		
1977-1979	<b>BUICK RIVIERA</b>	5.7L V8 350 CID		1969	<b>FORD FALCON</b>	5.0L V8 5000cc 302 CID		
1977-1980	<b>BUICK ELECTRA</b>	5.7L V8 350 CID		1969	<b>FORD GALAXIE</b>	5.8L V8 5800cc 351 CID		
1977-1980	<b>OLDSMOBILE STARFIRE</b>	3.8L V6 3800cc 231 CID		1969	<b>FORD MUSTANG</b>	5.0L V8 5000cc 302 CID		
1977-1980	<b>PONTIAC SUNBIRD</b>	3.8L V6 3800cc 231 CID		1973-1974	<b>FORD B100</b>	4.7L V8 4700cc 289 CID		
1977-1985	<b>BUICK LESABRE</b>	3.8L V6 3800cc 231 CID		1973-1974	<b>FORD B100</b>	5.0L V8 5000cc 302 CID		
1977-1985	<b>OLDSMOBILE DELTA 88</b>	3.8L V6 3800cc 231 CID		1975-1977	<b>FORD BRONCO</b>	5.0L V8 302 CID		
1978-1979	<b>BUICK CENTURY</b>	3.2L V6 196 CID		<b>US1028H</b>	1975-1977	<b>FORD BRONCO</b>	5.0L V8 302 CID	
1978-1979	<b>BUICK REGAL</b>	3.2L V6 196 CID	<b>US1040</b>		1975	<b>CHRYSLER IMPERIAL</b>	7.2L V8 440 CID	
1978-1979	<b>BUICK SKYLARK</b>	3.8L V6 3800cc 231 CID			1975	<b>PLYMOUTH FURY</b>	7.2L V8 440 CID	
1978-1979	<b>CHEVROLET MONZA</b>	3.2L V6 196 CID			1975-1976	<b>DODGE CORONET</b>	6.6L V8 400 CID	
1978-1979	<b>OLDSMOBILE OMEGA</b>	3.8L V6 3800cc 231 CID			1975-1976	<b>DODGE CORONET</b>	7.2L V8 440 CID	
1978-1979	<b>PONTIAC PHOENIX</b>	3.8L V6 3800cc 231 CID			1975-1977	<b>DODGE ROYAL MONACO</b>	6.6L V8 400 CID	
1978-1980	<b>BUICK SKYHAWK</b>	3.8L V6 3800cc 231 CID			1975-1977	<b>DODGE ROYAL MONACO</b>	7.2L V8 440 CID	
1978-1980	<b>CHEVROLET MONZA</b>	3.8L V6 3800cc 231 CID			1975-1977	<b>DODGE W100</b>	6.6L V8 400 CID	
1978-1980	<b>OLDSMOBILE CUTLASS SALON</b>	3.8L V6 3800cc 231 CID			1975-1977	<b>DODGE W100</b>	7.2L V8 440 CID	
1978-1980	<b>PONTIAC CATALINA</b>	5.7L V8 350 CID			1975-1977	<b>PLYMOUTH GRAN FURY</b>	6.6L V8 400 CID	
1978-1981	<b>BUICK CENTURY</b>	3.8L V6 3800cc 231 CID		1975-1977	<b>PLYMOUTH GRAN FURY</b>	7.2L V8 440 CID		
1978-1981	<b>PONTIAC CATALINA</b>	3.8L V6 3800cc 231 CID	1975-1978	<b>CHRYSLER CORDOBA</b>	6.6L V8 400 CID			
1978-1981	<b>PONTIAC FIREBIRD</b>	3.8L V6 3800cc 231 CID	1975-1978	<b>CHRYSLER NEWPORT</b>	6.6L V8 400 CID			
1978-1981	<b>PONTIAC LEMANS</b>	3.8L V6 3800cc 231 CID	1975-1978	<b>CHRYSLER NEWPORT</b>	7.2L V8 440 CID			
1978-1983	<b>CHEVROLET MALIBU</b>	3.8L V6 3800cc 231 CID	1975-1978	<b>CHRYSLER NEW YORKER</b>	6.6L V8 400 CID			
1978-1984	<b>CHEVROLET EL CAMINO</b>	3.8L V6 3800cc 231 CID	1975-1978	<b>CHRYSLER NEW YORKER</b>	7.2L V8 440 CID			
1978-1984	<b>CHEVROLET MONTE CARLO</b>	3.8L V6 3800cc 231 CID	1975-1978	<b>DODGE B200</b>	7.2L V8 440 CID			
1978-1984	<b>OLDSMOBILE CUTLASS CALAIS</b>	3.8L V6 3800cc 231 CID	1975-1978	<b>DODGE B300</b>	7.2L V8 440 CID			
1978-1987	<b>BUICK REGAL</b>	3.8L V6 3800cc 231 CID	1975-1978	<b>DODGE CHARGER</b>	6.6L V8 400 CID			
1978-1987	<b>PONTIAC GRAND PRIX</b>	3.8L V6 3800cc 231 CID	1975-1978	<b>DODGE D100</b>	7.2L V8 440 CID			
1979	<b>BUICK CENTURY</b>	3.8L V6 231 CID	1975-1978	<b>DODGE D200</b>	6.6L V8 400 CID			
1979	<b>BUICK REGAL</b>	3.8L V6 231 CID	1975-1978	<b>DODGE D200</b>	7.2L V8 440 CID			
1979	<b>CHEVROLET EL CAMINO</b>	3.8L V6 231 CID	1975-1978	<b>DODGE D300</b>	7.2L V8 440 CID			
1979	<b>CHEVROLET MALIBU</b>	3.8L V6 231 CID	1975-1978	<b>DODGE MONACO</b>	6.6L V8 400 CID			
1979	<b>CHEVROLET MONTE CARLO</b>	3.8L V6 231 CID	1975-1978	<b>DODGE MONACO</b>	7.2L V8 440 CID			
1979	<b>OLDSMOBILE CUTLASS CALAIS</b>	3.8L V6 231 CID	1975-1978	<b>DODGE RAMCHARGER</b>	7.2L V8 440 CID			
1979	<b>OLDSMOBILE CUTLASS SALON</b>	3.8L V6 231 CID	1975-1978	<b>DODGE W200</b>	7.2L V8 440 CID			
1979	<b>PONTIAC GRAND AM</b>	3.8L V6 3800cc 231 CID	1975-1978	<b>DODGE W300</b>	7.2L V8 440 CID			
1979	<b>PONTIAC GRAND PRIX</b>	3.8L V6 231 CID	1975-1978	<b>PLYMOUTH FURY</b>	6.6L V8 400 CID			
1979	<b>PONTIAC LEMANS</b>	3.8L V6 231 CID	1975-1978	<b>PLYMOUTH TRAILDUSTER</b>	7.2L V8 440 CID			
1979-1980	<b>PONTIAC BONNEVILLE</b>	5.7L V8 350 CID	1976-1978	<b>DODGE B200</b>	6.6L V8 400 CID			
1979-1985	<b>BUICK RIVIERA</b>	3.8L V6 3800cc 231 CID	1976-1978	<b>DODGE B300</b>	6.6L V8 400 CID			
1980	<b>BUICK ESTATE WAGON</b>	5.7L V8 350 CID	1976-1978	<b>DODGE D100</b>	6.6L V8 400 CID			
1980-1981	<b>CHEVROLET CAMARO</b>	3.8L V6 3800cc 231 CID	1976-1978	<b>DODGE D300</b>	6.6L V8 400 CID			
1980-1981	<b>OLDSMOBILE CUTLASS</b>	3.8L V6 3800cc 231 CID	1976-1978	<b>DODGE W200</b>	6.6L V8 400 CID			
1980-1981	<b>PONTIAC GRAND LEMANS</b>	3.8L V6 3800cc 231 CID	1976-1978	<b>DODGE W300</b>	6.6L V8 400 CID			
1980-1982	<b>CADILLAC DEVILLE</b>	4.1L V6 252 CID	1976-1978	<b>PLYMOUTH PB200</b>	6.6L V8 400 CID			
1980-1982	<b>CADILLAC FLEETWOOD</b>	4.1L V6 252 CID	1976-1978	<b>PLYMOUTH PB200</b>	7.2L V8 440 CID			
1980-1982	<b>OLDSMOBILE CUTLASS CRUISER</b>	3.8L V6 3800cc 231 CID	1976-1978	<b>PLYMOUTH PB300</b>	6.6L V8 400 CID			
1980-1984	<b>BUICK ELECTRA</b>	4.1L V6 252 CID	1976-1978	<b>PLYMOUTH PB300</b>	7.2L V8 440 CID			
1980-1984	<b>BUICK LESABRE</b>	4.1L V6 252 CID	1977-1978	<b>DODGE D150</b>	6.6L V8 400 CID			
1980-1984	<b>CHEVROLET CAPRICE</b>	3.8L V6 3800cc 231 CID	1977-1978	<b>DODGE RAMCHARGER</b>	6.6L V8 400 CID			
1980-1984	<b>CHEVROLET IMPALA</b>	3.8L V6 3800cc 231 CID	1977-1978	<b>PLYMOUTH FURY</b>	7.2L V8 440 CID			
1980-1984	<b>GMC CABALLERO</b>	3.8L V6 3800cc 231 CID	1977-1978	<b>PLYMOUTH TRAILDUSTER</b>	6.6L V8 400 CID			
1980-1986	<b>PONTIAC BONNEVILLE</b>	3.8L V6 3800cc 231 CID	1978	<b>DODGE D150</b>	7.2L V8 440 CID			
1980-1987	<b>OLDSMOBILE CUTLASS SUPREME</b>	3.8L V6 3800cc 231 CID	1978	<b>DODGE MAGNUM</b>	6.6L V8 400 CID			
1981-1982	<b>CADILLAC ELDORADO</b>	4.1L V6 252 CID	<b>US1042</b>	1975-1979	<b>FORD COURIER</b>	1.8L L4 110 CID		
1981-1982	<b>CADILLAC SEVILLE</b>	4.1L V6 252 CID		1977-1978	<b>MAZDA B1800</b>	1.8L L4 1796cc		
1981-1983	<b>OLDSMOBILE 98</b>	4.1L V6 252 CID		1979	<b>FORD COURIER</b>	2.0L L4 1989cc 122 CID		
1981-1984	<b>BUICK RIVIERA</b>	4.1L V6 252 CID		1979-1982	<b>MAZDA 626</b>	2.0L L4 1970cc		
1981-1984	<b>OLDSMOBILE TORONADO</b>	4.1L V6 252 CID		1979-1984	<b>MAZDA B2000</b>	2.0L L4 1970cc		

WATER PUMPS



# WATER PUMP BUYERS GUIDE



USMWW	Years	Application	Engine	USMWW	Years	Application	Engine
<b>US1042</b>	1981-1982	<b>FORD COURIER</b>	2.0L L4 1989cc 122 CID	<b>US1044</b>	1971-1972	<b>MERCURY COMET</b>	2.8L L6 170 CID
<b>US1044</b>	1960-1961	<b>FORD COUNTRY SEDAN</b>	2.4L L6 2360cc 144 CID	1971-1974	<b>MERCURY COMET</b>	3.3L L6 3278cc 200 CID	
	1960-1961	<b>FORD COUNTRY SEDAN</b>	2.8L L6 2786cc 170 CID	1971-1975	<b>MERCURY COMET</b>	3.3L L6 200 CID	
	1960-1961	<b>FORD COUNTRY SQUIRE</b>	2.4L L6 2360cc 144 CID	1973-1974	<b>FORD BRONCO</b>	3.3L L6 200 CID	
	1960-1961	<b>FORD COUNTRY SQUIRE</b>	2.8L L6 2786cc 170 CID	1973-1974	<b>FORD BRONCO</b>	3.3L L6 3277cc 200 CID	
	1960-1961	<b>FORD RANCH WAGON</b>	2.4L L6 2360cc 144 CID	1973-1974	<b>FORD BRONCO</b>	3.3L L6 3278cc 200 CID	
	1960-1963	<b>MERCURY COMET</b>	2.4L L6 2360cc 144 CID	1975	<b>FORD GRANADA</b>	3.3L L6 200 CID	
	1960-1964	<b>FORD FALCON</b>	2.4L L6 2360cc 144 CID	1975	<b>MERCURY MONARCH</b>	3.3L L6 200 CID	
	1960-1964	<b>FORD P-100</b>	2.4L L6 2360cc 144 CID	<b>US1045</b>	1975	<b>BUICK ELECTRA</b>	7.5L V8 455 CID
	1960-1964	<b>FORD RANCHERO</b>	2.4L L6 2360cc 144 CID	1975	<b>BUICK ESTATE WAGON</b>	7.5L V8 455 CID	
	1960-1969	<b>FORD FALCON</b>	2.8L L6 2786cc 170 CID	1975	<b>BUICK LESABRE</b>	7.5L V8 455 CID	
	1960-1969	<b>FORD RANCH WAGON</b>	2.8L L6 2786cc 170 CID	1975	<b>BUICK RIVIERA</b>	7.5L V8 455 CID	
	1961-1963	<b>MERCURY COMET</b>	2.4L L6 144 CID	<b>US1046</b>	1972-1974	<b>CHEVROLET LUV PICKUP</b>	1.8L L4 111 CID
	1961-1963	<b>MERCURY METEOR</b>	2.8L L6 2786cc 170 CID	1975	<b>CHEVROLET LUV</b>	1.8L L4 111 CID	
	1961-1964	<b>FORD FALCON SEDAN DELIVERY</b>	2.4L L6 2360cc 144 CID	<b>US1047</b>	1975-1978	<b>FORD MUSTANG II</b>	2.8L V6 171 CID
	1961-1965	<b>FORD ECONOLINE</b>	2.4L L6 144 CID	1975-1979	<b>FORD PINTO</b>	2.8L V6 171 CID	
	1961-1965	<b>FORD FALCON SEDAN DELIVERY</b>	2.8L L6 2786cc 170 CID	1975-1979	<b>MERCURY BOBCAT</b>	2.8L V6 171 CID	
	1961-1965	<b>FORD RANCHERO</b>	2.8L L6 2786cc 170 CID	1979	<b>FORD MUSTANG</b>	2.8L V6 171 CID	
	1961-1967	<b>FORD P-350</b>	2.8L L6 2786cc 170 CID	1979	<b>MERCURY CAPRI</b>	2.8L V6 171 CID	
	1961-1970	<b>FORD P-100</b>	2.8L L6 2786cc 170 CID	<b>US1052</b>	1974	<b>FORD E-100 ECONOLINE</b>	5.0L V8 302 CID
	1961-1972	<b>MERCURY COMET</b>	2.8L L6 2786cc 170 CID	1974	<b>FORD E-300 ECONOLINE</b>	5.0L V8 302 CID	
	1962-1963	<b>FORD CLUB WAGON</b>	2.8L L6 170 CID	<b>US1053</b>	1970-1971	<b>DODGE CHARGER</b>	5.2L V8 5200cc 318 CID
	1962-1963	<b>MERCURY METEOR</b>	2.8L L6 170 CID	1970-1971	<b>DODGE CORONET</b>	5.2L V8 5200cc 318 CID	
	1962-1963	<b>MERCURY VILLAGER</b>	2.4L L6 2360cc 144 CID	1970-1974	<b>DODGE MONACO</b>	5.2L V8 5200cc 318 CID	
	1962-1964	<b>FORD CLUB WAGON</b>	2.4L L6 2360cc 144 CID	1970-1974	<b>PLYMOUTH VALIANT</b>	5.2L V8 5212cc 318 CID	
	1962-1964	<b>FORD FALCON</b>	2.4L L6 144 CID	1972	<b>DODGE CHARGER</b>	5.9L V8 5900cc 360 CID	
	1962-1964	<b>FORD STATION BUS</b>	2.4L L6 144 CID	1972-1973	<b>DODGE MONACO</b>	5.9L V8 5900cc 360 CID	
	1962-1966	<b>FORD ECONOLINE</b>	2.8L L6 170 CID	1975	<b>DODGE ROYAL MONACO</b>	5.2L V8 318 CID	
	1962-1966	<b>FORD FAIRLANE</b>	2.8L L6 2786cc 170 CID	1975	<b>DODGE W200</b>	5.2L V8 318 CID	
	1962-1967	<b>FORD CLUB WAGON</b>	2.8L L6 2786cc 170 CID	1975-1976	<b>DODGE CORONET</b>	5.2L V8 318 CID	
	1962-1967	<b>MERCURY VILLAGER</b>	2.8L L6 2786cc 170 CID	1975-1976	<b>DODGE CORONET</b>	5.9L V8 360 CID	
	1962-1969	<b>FORD FALCON</b>	2.8L L6 170 CID	1975-1976	<b>DODGE DART</b>	5.2L V8 318 CID	
	1963	<b>FORD FORD 300</b>	3.3L L6 3277cc 200 CID	1975-1976	<b>DODGE DART</b>	5.9L V8 360 CID	
	1963	<b>FORD GALAXIE</b>	3.3L L6 3277cc 200 CID	1975-1976	<b>PLYMOUTH DUSTER</b>	5.2L V8 318 CID	
	1963	<b>FORD GALAXIE 500</b>	3.3L L6 200 CID	1975-1976	<b>PLYMOUTH DUSTER</b>	5.9L V8 360 CID	
	1963	<b>MERCURY COUNTRY CRUISER</b>	3.3L L6 3277cc 200 CID	1975-1976	<b>PLYMOUTH SCAMP</b>	5.2L V8 318 CID	
	1963	<b>MERCURY METEOR</b>	3.3L L6 3277cc 200 CID	1975-1976	<b>PLYMOUTH VALIANT</b>	5.2L V8 318 CID	
	1963-1964	<b>FORD SPRINT</b>	2.8L L6 2786cc 170 CID	1975-1977	<b>DODGE ROYAL MONACO</b>	5.9L V8 360 CID	
	1963-1964	<b>FORD SPRINT</b>	3.3L L6 3277cc 200 CID	1975-1977	<b>DODGE W100</b>	5.2L V8 5211cc 318 CID	
	1963-1967	<b>MERCURY VILLAGER</b>	3.3L L6 3277cc 200 CID	1975-1977	<b>DODGE W100</b>	5.9L V8 360 CID	
	1963-1969	<b>FORD FAIRLANE</b>	3.3L L6 3277cc 200 CID	1975-1977	<b>PLYMOUTH GRAN FURY</b>	5.2L V8 318 CID	
	1963-1970	<b>FORD RANCH WAGON</b>	3.3L L6 3277cc 200 CID	1975-1977	<b>PLYMOUTH GRAN FURY</b>	5.9L V8 360 CID	
	1963-1974	<b>MERCURY COMET</b>	3.3L L6 3277cc 200 CID	1975-1978	<b>DODGE CHARGER</b>	5.2L V8 318 CID	
	1964	<b>FORD RANCH WAGON</b>	2.4L L6 2360cc 144 CID	1975-1978	<b>DODGE CHARGER</b>	5.9L V8 360 CID	
	1964	<b>MERCURY COMET</b>	2.8L L6 170 CID	1975-1978	<b>DODGE MONACO</b>	5.2L V8 318 CID	
	1964	<b>MERCURY CYCLONE</b>	3.3L L6 3277cc 200 CID	1975-1978	<b>DODGE MONACO</b>	5.9L V8 360 CID	
	1964-1965	<b>FORD FALCON SEDAN DELIVERY</b>	3.3L L6 3277cc 200 CID	1975-1978	<b>DODGE W300</b>	5.2L V8 5211cc 318 CID	
	1964-1965	<b>FORD MUSTANG</b>	2.8L L6 2786cc 170 CID	1975-1978	<b>PLYMOUTH FURY</b>	5.2L V8 318 CID	
	1964-1967	<b>MERCURY CALIENTE</b>	3.3L L6 3277cc 200 CID	1975-1978	<b>PLYMOUTH FURY</b>	5.9L V8 360 CID	
	1964-1968	<b>FORD RANCHERO</b>	3.3L L6 3277cc 200 CID	1975-1979	<b>DODGE D100</b>	5.2L V8 5211cc 318 CID	
	1964-1970	<b>FORD FALCON</b>	3.3L L6 3277cc 200 CID	1975-1979	<b>DODGE D100</b>	5.9L V8 360 CID	
	1964-1970	<b>FORD MUSTANG</b>	3.3L L6 3277cc 200 CID	1975-1980	<b>CHRYSLER NEWPORT</b>	5.9L V8 360 CID	
	1965	<b>FORD STATION BUS</b>	2.8L L6 170 CID	1975-1980	<b>DODGE B100</b>	5.2L V8 5211cc 318 CID	
	1965	<b>MERCURY COMET</b>	3.3L L6 200 CID	1975-1980	<b>DODGE B200</b>	5.2L V8 5211cc 318 CID	
	1965-1969	<b>FORD COUNTRY SEDAN</b>	2.8L L6 2786cc 170 CID	1975-1980	<b>DODGE B200</b>	5.9L V8 360 CID	
	1965-1969	<b>FORD COUNTRY SQUIRE</b>	2.8L L6 2786cc 170 CID	1975-1980	<b>DODGE B300</b>	5.2L V8 5211cc 318 CID	
	1965-1969	<b>FORD FAIRLANE</b>	3.3L L6 200 CID	1975-1980	<b>DODGE B300</b>	5.9L V8 360 CID	
	1965-1970	<b>FORD COUNTRY SEDAN</b>	3.3L L6 3277cc 200 CID	1975-1980	<b>DODGE D200</b>	5.2L V8 5211cc 318 CID	
	1965-1970	<b>FORD COUNTRY SQUIRE</b>	3.3L L6 3277cc 200 CID	1975-1980	<b>DODGE D200</b>	5.9L V8 360 CID	
	1965-1970	<b>FORD FALCON</b>	3.3L L6 200 CID	1975-1980	<b>DODGE D300</b>	5.2L V8 5211cc 318 CID	
	1966-1967	<b>FORD CLUB WAGON</b>	2.8L L6 170 CID	1975-1980	<b>DODGE D300</b>	5.9L V8 360 CID	
	1966-1967	<b>MERCURY VOYAGER</b>	2.8L L6 2786cc 170 CID	1975-1980	<b>DODGE W200</b>	5.2L V8 5211cc 318 CID	
	1966-1967	<b>MERCURY VOYAGER</b>	3.3L L6 3277cc 200 CID	1975-1980	<b>DODGE W200</b>	5.9L V8 360 CID	
	1966-1968	<b>FORD RANCHERO</b>	3.3L L6 200 CID	1975-1980	<b>DODGE W300</b>	5.9L V8 360 CID	
	1966-1972	<b>FORD BRONCO</b>	2.8L L6 2786cc 170 CID	1975-1980	<b>PLYMOUTH PB100</b>	5.2L V8 5211cc 318 CID	
	1967-1972	<b>FORD BRONCO</b>	2.8L L6 170 CID	1975-1980	<b>PLYMOUTH PB200</b>	5.2L V8 5211cc 318 CID	
	1968	<b>FORD RANCHERO</b>	3.3L L6 3278cc 200 CID	1975-1980	<b>PLYMOUTH PB200</b>	5.9L V8 360 CID	
	1968	<b>FORD TORINO</b>	3.3L L6 200 CID	1975-1980	<b>PLYMOUTH PB300</b>	5.2L V8 5211cc 318 CID	
	1968	<b>FORD TORINO</b>	3.3L L6 3277cc 200 CID	1975-1980	<b>PLYMOUTH PB300</b>	5.9L V8 360 CID	
	1968	<b>FORD TORINO</b>	3.3L L6 3278cc 200 CID	1975-1981	<b>DODGE RAMCHARGER</b>	5.9L V8 360 CID	
	1968	<b>MERCURY COMET</b>	3.3L L6 200 CID	1975-1981	<b>PLYMOUTH TRAILDUSTER</b>	5.2L V8 5211cc 318 CID	
	1968	<b>MERCURY COMET</b>	3.3L L6 3278cc 200 CID	1975-1981	<b>PLYMOUTH TRAILDUSTER</b>	5.9L V8 360 CID	
	1968	<b>MERCURY MONTEGO</b>	3.3L L6 200 CID	1975-1982	<b>CHRYSLER CORDOBA</b>	5.9L V8 360 CID	
	1968	<b>MERCURY MONTEGO</b>	3.3L L6 3277cc 200 CID	1975-1983	<b>CHRYSLER CORDOBA</b>	5.2L V8 318 CID	
	1968	<b>MERCURY MONTEGO</b>	3.3L L6 3278cc 200 CID	1975-1991	<b>DODGE RAMCHARGER</b>	5.2L V8 5211cc 318 CID	
	1968-1969	<b>FORD FAIRLANE</b>	3.3L L6 3278cc 200 CID	1976	<b>PLYMOUTH VALIANT</b>	5.9L V8 360 CID	
	1968-1970	<b>FORD FALCON</b>	3.3L L6 3278cc 200 CID	1976-1978	<b>DODGE B100</b>	5.9L V8 360 CID	
	1968-1970	<b>FORD MUSTANG</b>	3.3L L6 200 CID	1976-1978	<b>PLYMOUTH PB100</b>	5.9L V8 360 CID	
	1968-1970	<b>FORD MUSTANG</b>	3.3L L6 3278cc 200 CID	1976-1980	<b>DODGE ASPEN</b>	5.2L V8 318 CID	
	1969-1970	<b>FORD E-300 ECONOLINE</b>	2.8L L6 170 CID	1976-1980	<b>DODGE ASPEN</b>	5.9L V8 360 CID	
	1969-1971	<b>FORD E-100 ECONOLINE</b>	2.8L L6 170 CID	1976-1980	<b>PLYMOUTH VOLARE</b>	5.2L V8 318 CID	
	1969-1971	<b>FORD E-100 ECONOLINE</b>	2.8L L6 2786cc 170 CID	1976-1980	<b>PLYMOUTH VOLARE</b>	5.9L V8 360 CID	
	1969-1971	<b>FORD E-200 ECONOLINE</b>	2.8L L6 170 CID	1977	<b>CHRYSLER LEBARON</b>	5.9L V8 5900cc 360 CID	
	1970	<b>FORD P-350</b>	2.8L L6 2786cc 170 CID	1977	<b>DODGE ROYAL MONACO</b>	5.2L V8 318 CID	
	1970-1972	<b>FORD MAVERICK</b>	2.8L L6 170 CID	1977-1978	<b>DODGE DART</b>	5.9L V8 5900cc 360 CID	
	1970-1972	<b>FORD MAVERICK</b>	2.8L L6 2786cc 170 CID	1977-1980	<b>CHRYSLER NEW YORKER</b>	5.9L V8 360 CID	
	1970-1974	<b>FORD MAVERICK</b>	3.3L L6 3277cc 200 CID	1977-1981	<b>CHRYSLER LEBARON</b>	5.2L V8 318 CID	
	1970-1974	<b>FORD MAVERICK</b>	3.3L L6 3278cc 200 CID	1977-1981	<b>DODGE W150</b>	5.9L V8 360 CID	
	1970-1975	<b>FORD MAVERICK</b>	3.3L L6 200 CID	1977-1989	<b>DODGE DIPLOMAT</b>	5.2L V8 318 CID	



USMW	Years	Application	Engine	USMW	Years	Application	Engine	
<b>US1053</b>	1977-1991	<b>DODGE</b> D150	5.2L V8 5211cc 318 CID	<b>US1053H</b>	1975-1976	<b>PLYMOUTH</b> DUSTER	5.2L V8 318 CID	
	1977-1991	<b>DODGE</b> D150	5.9L V8 360 CID		1975-1976	<b>PLYMOUTH</b> DUSTER	5.9L V8 360 CID	
	1977-1991	<b>DODGE</b> W150	5.2L V8 5211cc 318 CID		1975-1976	<b>PLYMOUTH</b> SCAMP	5.2L V8 318 CID	
	1978-1979	<b>CHRYSLER</b> TOWN & COUNTRY	5.9L V8 360 CID		1975-1976	<b>PLYMOUTH</b> VALIANT	5.2L V8 318 CID	
	1978-1979	<b>DODGE</b> DIPLOMAT	5.9L V8 360 CID		1975-1977	<b>DODGE</b> ROYAL MONACO	5.9L V8 360 CID	
	1978-1979	<b>DODGE</b> MAGNUM	5.2L V8 318 CID		1975-1977	<b>DODGE</b> W100	5.2L V8 5211cc 318 CID	
	1978-1979	<b>DODGE</b> MAGNUM	5.9L V8 360 CID		1975-1977	<b>DODGE</b> W100	5.9L V8 360 CID	
	1978-1981	<b>CHRYSLER</b> TOWN & COUNTRY	5.2L V8 318 CID		1975-1977	<b>PLYMOUTH</b> GRAN FURY	5.2L V8 318 CID	
	1978-1982	<b>CHRYSLER</b> LEBARON	5.9L V8 360 CID		1975-1977	<b>PLYMOUTH</b> GRAN FURY	5.9L V8 360 CID	
	1979-1980	<b>DODGE</b> ST. REGIS	5.9L V8 360 CID		1975-1978	<b>DODGE</b> CHARGER	5.2L V8 318 CID	
	1979-1981	<b>CHRYSLER</b> NEWPORT	5.2L V8 318 CID		1975-1978	<b>DODGE</b> CHARGER	5.9L V8 360 CID	
	1979-1981	<b>DODGE</b> ST. REGIS	5.2L V8 318 CID		1975-1978	<b>DODGE</b> MONACO	5.2L V8 318 CID	
	1979-1982	<b>CHRYSLER</b> NEW YORKER	5.2L V8 318 CID		1975-1978	<b>DODGE</b> MONACO	5.9L V8 360 CID	
	1980	<b>DODGE</b> CB300	5.2L V8 5211cc 318 CID		1975-1978	<b>DODGE</b> W300	5.2L V8 5211cc 318 CID	
	1980	<b>DODGE</b> CB300	5.9L V8 360 CID		1975-1978	<b>PLYMOUTH</b> FURY	5.2L V8 318 CID	
	1980	<b>DODGE</b> D150	5.9L V8 5900cc 360 CID		1975-1978	<b>PLYMOUTH</b> FURY	5.9L V8 360 CID	
	1980	<b>DODGE</b> D350	5.2L V8 5200cc 318 CID		1975-1979	<b>DODGE</b> D100	5.2L V8 5211cc 318 CID	
	1980	<b>DODGE</b> MIRADA	5.9L V8 360 CID		1975-1979	<b>DODGE</b> D100	5.9L V8 360 CID	
	1980	<b>DODGE</b> RD200	5.2L V8 5211cc 318 CID		1975-1980	<b>CHRYSLER</b> NEWPORT	5.9L V8 360 CID	
	1980	<b>DODGE</b> RD200	5.9L V8 360 CID		1975-1980	<b>DODGE</b> B100	5.2L V8 5211cc 318 CID	
	1980	<b>DODGE</b> W300	5.2L V8 5211cc 318 CID		1975-1980	<b>DODGE</b> B200	5.2L V8 5211cc 318 CID	
	1980	<b>PLYMOUTH</b> GRAN FURY	5.9L V8 360 CID		1975-1980	<b>DODGE</b> B200	5.9L V8 360 CID	
	1980-1982	<b>CHRYSLER</b> CORDOBA	5.9L V8 5900cc 360 CID		1975-1980	<b>DODGE</b> B300	5.2L V8 5211cc 318 CID	
	1980-1982	<b>CHRYSLER</b> LEBARON	5.9L V8 5900cc 360 CID		1975-1980	<b>DODGE</b> B300	5.9L V8 360 CID	
	1980-1982	<b>DODGE</b> DART	5.9L V8 5900cc 360 CID		1975-1980	<b>DODGE</b> D200	5.2L V8 5211cc 318 CID	
	1980-1982	<b>DODGE</b> MAGNUM	5.9L V8 5900cc 360 CID		1975-1980	<b>DODGE</b> D200	5.9L V8 360 CID	
	1980-1983	<b>DODGE</b> D350	5.9L V8 5900cc 360 CID		1975-1980	<b>DODGE</b> D300	5.2L V8 5211cc 318 CID	
	1980-1983	<b>DODGE</b> MIRADA	5.2L V8 318 CID		1975-1980	<b>DODGE</b> D300	5.9L V8 360 CID	
	1980-1989	<b>PLYMOUTH</b> GRAN FURY	5.2L V8 318 CID		1975-1980	<b>DODGE</b> W200	5.2L V8 5211cc 318 CID	
	1980-1990	<b>DODGE</b> RAMCHARGER	5.9L V8 5900cc 360 CID		1975-1980	<b>DODGE</b> W200	5.9L V8 360 CID	
	1981	<b>DODGE</b> B250	5.9L V8 360 CID		1975-1980	<b>DODGE</b> W300	5.9L V8 360 CID	
	1981	<b>PLYMOUTH</b> PB150	5.2L V8 5211cc 318 CID		1975-1980	<b>PLYMOUTH</b> PB100	5.2L V8 5211cc 318 CID	
	1981	<b>PLYMOUTH</b> PB250	5.9L V8 360 CID		1975-1980	<b>PLYMOUTH</b> PB200	5.2L V8 5211cc 318 CID	
	1981-1982	<b>DODGE</b> D250	5.9L V8 360 CID		1975-1980	<b>PLYMOUTH</b> PB200	5.9L V8 360 CID	
	1981-1982	<b>DODGE</b> W250	5.9L V8 360 CID		1975-1980	<b>PLYMOUTH</b> PB300	5.2L V8 5211cc 318 CID	
	1981-1983	<b>CHRYSLER</b> IMPERIAL	5.2L V8 318 CID		1975-1980	<b>PLYMOUTH</b> PB300	5.9L V8 360 CID	
	1981-1983	<b>DODGE</b> D350	5.2L V8 5211cc 318 CID		1975-1981	<b>DODGE</b> RAMCHARGER	5.9L V8 360 CID	
	1981-1983	<b>PLYMOUTH</b> PB250	5.2L V8 5211cc 318 CID		1975-1981	<b>PLYMOUTH</b> TRAILDUSTER	5.2L V8 5211cc 318 CID	
	1981-1983	<b>PLYMOUTH</b> PB350	5.2L V8 5211cc 318 CID		1975-1981	<b>PLYMOUTH</b> TRAILDUSTER	5.9L V8 360 CID	
	1981-1983	<b>PLYMOUTH</b> PB350	5.9L V8 360 CID		1975-1982	<b>CHRYSLER</b> CORDOBA	5.9L V8 360 CID	
	1981-1991	<b>DODGE</b> B150	5.2L V8 5211cc 318 CID		1975-1983	<b>CHRYSLER</b> CORDOBA	5.2L V8 318 CID	
	1981-1991	<b>DODGE</b> B250	5.2L V8 5211cc 318 CID		1975-1991	<b>DODGE</b> RAMCHARGER	5.2L V8 5211cc 318 CID	
	1981-1991	<b>DODGE</b> B350	5.2L V8 5211cc 318 CID		1976	<b>PLYMOUTH</b> VALIANT	5.9L V8 360 CID	
	1981-1991	<b>DODGE</b> D250	5.2L V8 5211cc 318 CID		1976-1978	<b>DODGE</b> B100	5.9L V8 360 CID	
	1981-1991	<b>DODGE</b> W250	5.2L V8 5211cc 318 CID		1976-1978	<b>PLYMOUTH</b> PB100	5.9L V8 360 CID	
	1981-1992	<b>DODGE</b> B350	5.9L V8 360 CID		1976-1980	<b>DODGE</b> ASPEN	5.2L V8 318 CID	
	1981-1992	<b>DODGE</b> D350	5.9L V8 360 CID		1976-1980	<b>DODGE</b> ASPEN	5.9L V8 360 CID	
	1981-1992	<b>DODGE</b> W350	5.9L V8 360 CID		1976-1980	<b>PLYMOUTH</b> VOLARE	5.2L V8 318 CID	
	1982	<b>DODGE</b> D350	5.2L V8 5200cc 318 CID		1976-1980	<b>PLYMOUTH</b> VOLARE	5.9L V8 360 CID	
	1982	<b>DODGE</b> DART	5.9L V8 360 CID		1977	<b>DODGE</b> ROYAL MONACO	5.2L V8 318 CID	
	1982	<b>DODGE</b> MAGNUM	5.9L V8 360 CID		1977-1980	<b>CHRYSLER</b> NEW YORKER	5.9L V8 360 CID	
	1982-1983	<b>DODGE</b> D150	5.9L V8 5900cc 360 CID		1977-1981	<b>CHRYSLER</b> LEBARON	5.2L V8 318 CID	
	1982-1983	<b>DODGE</b> W350	5.2L V8 5211cc 318 CID		1977-1981	<b>DODGE</b> W150	5.9L V8 360 CID	
	1983	<b>DODGE</b> DIPLOMAT	5.2L V8 5211cc 318 CID		1977-1989	<b>DODGE</b> DIPLOMAT	5.2L V8 318 CID	
	1983	<b>PLYMOUTH</b> PB150	5.2L V8 5211cc 318 CID		1977-1991	<b>DODGE</b> D150	5.2L V8 5211cc 318 CID	
	1983-1989	<b>CHRYSLER</b> FIFTH AVENUE	5.2L V8 318 CID		1977-1991	<b>DODGE</b> W150	5.2L V8 5211cc 318 CID	
	1984-1991	<b>DODGE</b> W150	5.9L V8 360 CID		1978-1979	<b>CHRYSLER</b> TOWN & COUNTRY	5.9L V8 360 CID	
	1984-1992	<b>DODGE</b> B250	5.9L V8 360 CID		1978-1979	<b>DODGE</b> DIPLOMAT	5.9L V8 360 CID	
	1984-1992	<b>DODGE</b> D250	5.9L V8 360 CID		1978-1979	<b>DODGE</b> MAGNUM	5.2L V8 318 CID	
	1984-1992	<b>DODGE</b> RAMCHARGER	5.9L V8 360 CID		1978-1979	<b>DODGE</b> MAGNUM	5.9L V8 360 CID	
	1984-1992	<b>DODGE</b> W250	5.9L V8 360 CID		1978-1981	<b>CHRYSLER</b> TOWN & COUNTRY	5.2L V8 318 CID	
	1985	<b>DODGE</b> DIPLOMAT	5.2L V8 5211cc 318 CID		1978-1982	<b>CHRYSLER</b> LEBARON	5.9L V8 360 CID	
	1985	<b>PLYMOUTH</b> GRAN FURY	5.2L V8 5211cc 318 CID		1979-1980	<b>DODGE</b> ST. REGIS	5.9L V8 360 CID	
	1985-1988	<b>DODGE</b> D100	5.9L V8 360 CID		1979-1981	<b>CHRYSLER</b> NEWPORT	5.2L V8 318 CID	
	1985-1989	<b>DODGE</b> D100	5.2L V8 5211cc 318 CID		1979-1981	<b>DODGE</b> ST. REGIS	5.2L V8 318 CID	
	1986-1988	<b>DODGE</b> W100	5.9L V8 360 CID		1979-1982	<b>CHRYSLER</b> NEW YORKER	5.2L V8 318 CID	
	1986-1989	<b>DODGE</b> W100	5.2L V8 5211cc 318 CID		1980	<b>DODGE</b> CB300	5.2L V8 5211cc 318 CID	
	1987-1991	<b>DODGE</b> DAKOTA	3.9L V6 3906cc 239 CID		1980	<b>DODGE</b> CB300	5.9L V8 360 CID	
	1988-1989	<b>DODGE</b> D100	3.9L V6 3906cc 239 CID		1980	<b>DODGE</b> MIRADA	5.9L V8 360 CID	
	1988-1991	<b>DODGE</b> B150	3.9L V6 3906cc 239 CID		1980	<b>DODGE</b> RD200	5.2L V8 5211cc 318 CID	
	1988-1991	<b>DODGE</b> B250	3.9L V6 3906cc 239 CID		1980	<b>DODGE</b> RD200	5.9L V8 360 CID	
	1988-1991	<b>DODGE</b> D150	3.9L V6 3906cc 239 CID		1980	<b>DODGE</b> W300	5.2L V8 5211cc 318 CID	
	1988-1991	<b>DODGE</b> D250	3.9L V6 3906cc 239 CID		1980	<b>PLYMOUTH</b> GRAN FURY	5.9L V8 360 CID	
	1988-1991	<b>DODGE</b> MICROBUS	5.9L V8 5900cc 360 CID		1980-1983	<b>DODGE</b> MIRADA	5.2L V8 318 CID	
	1989	<b>DODGE</b> DAKOTA	5.2L V8 5211cc 318 CID		1980-1989	<b>PLYMOUTH</b> GRAN FURY	5.2L V8 318 CID	
	1989	<b>DODGE</b> W100	3.9L V6 3906cc 239 CID		1981	<b>DODGE</b> B250	5.9L V8 360 CID	
	1989-1990	<b>DODGE</b> D150	5.9L V8 5900cc 360 CID		1981	<b>PLYMOUTH</b> PB150	5.2L V8 5211cc 318 CID	
	1989-1990	<b>DODGE</b> D250	5.9L V8 5900cc 360 CID		1981	<b>PLYMOUTH</b> PB250	5.9L V8 360 CID	
	1989-1990	<b>DODGE</b> D350	5.9L V8 5900cc 360 CID		1981-1982	<b>DODGE</b> D250	5.9L V8 360 CID	
	1989-1990	<b>DODGE</b> W250	5.9L V8 5900cc 360 CID		1981-1982	<b>DODGE</b> W250	5.9L V8 360 CID	
	1989-1991	<b>DODGE</b> W150	3.9L V6 3906cc 239 CID		1981-1983	<b>CHRYSLER</b> IMPERIAL	5.2L V8 318 CID	
	1991	<b>DODGE</b> DM350	5.9L V8 5904cc 360 CID		1981-1983	<b>DODGE</b> D350	5.2L V8 5211cc 318 CID	
	<b>US1053H</b>	1970-1974	<b>PLYMOUTH</b> VALIANT		5.2L V8 5212cc 318 CID	1981-1983	<b>PLYMOUTH</b> PB250	5.2L V8 5211cc 318 CID
		1975	<b>DODGE</b> ROYAL MONACO		5.2L V8 318 CID	1981-1983	<b>PLYMOUTH</b> PB350	5.2L V8 5211cc 318 CID
		1975	<b>DODGE</b> W200		5.2L V8 318 CID	1981-1983	<b>PLYMOUTH</b> PB350	5.9L V8 360 CID
		1975-1976	<b>DODGE</b> CORONET		5.2L V8 318 CID	1981-1991	<b>DODGE</b> B150	5.2L V8 5211cc 318 CID
		1975-1976	<b>DODGE</b> CORONET		5.9L V8 360 CID	1981-1991	<b>DODGE</b> B250	5.2L V8 5211cc 318 CID
		1975-1976	<b>DODGE</b> DART		5.2L V8 318 CID	1981-1991	<b>DODGE</b> B350	5.2L V8 5211cc 318 CID
		1975-1976	<b>DODGE</b> DART		5.9L V8 360 CID			

WATER PUMPS



# WATER PUMP BUYERS GUIDE



USMWW	Years	Application	Engine	USMWW	Years	Application	Engine
<b>US1053H</b>	1981-1991	<b>DODGE D250</b>	5.2L V8 5211cc 318 CID	<b>US1077</b>	1979	<b>AMERICAN MOTORS SPIRIT</b>	3.8L L6 232 CID
	1981-1991	<b>DODGE W250</b>	5.2L V8 5211cc 318 CID		1979	<b>AMERICAN MOTORS SPIRIT</b>	4.2L L6 258 CID
	1981-1992	<b>DODGE B350</b>	5.9L V8 360 CID	1980-1983	<b>JEEP J100</b>	4.6L L6 4600cc 282 CID	
	1981-1992	<b>DODGE D350</b>	5.9L V8 360 CID	<b>US1082</b>	1975	<b>FORD F-500</b>	5.4L L6 330 CID
	1981-1992	<b>DODGE W350</b>	5.9L V8 360 CID	<b>US1083</b>	1974-1975	<b>FORD F600</b>	
	1982	<b>DODGE DART</b>	5.9L V8 360 CID	<b>US1088</b>	1975	<b>CHEVROLET MONZA</b>	2.3L L4 2294cc 140 CID
	1982	<b>DODGE MAGNUM</b>	5.9L V8 360 CID		1975	<b>CHEVROLET VEGA</b>	2.3L L4 2294cc 140 CID
	1982-1983	<b>DODGE W350</b>	5.2L V8 5211cc 318 CID		1975	<b>PONTIAC ASTRE</b>	2.3L L4 2294cc 140 CID
	1983	<b>DODGE DIPLOMAT</b>	5.2L V8 5211cc 318 CID	<b>US1096</b>	1975-1977	<b>FORD F-500</b>	5.4L V8 330 CID
	1983	<b>PLYMOUTH PB150</b>	5.2L V8 5211cc 318 CID	<b>US1099</b>	1966	<b>INTERNATIONAL 1000A</b>	4.3L L6 4335cc 264 CID
	1983-1989	<b>CHRYSLER FIFTH AVENUE</b>	5.2L V8 318 CID		1966	<b>INTERNATIONAL 1000A</b>	4.3L V8 4360cc 266 CID
	1984-1991	<b>DODGE W150</b>	5.9L V8 360 CID	1966	<b>INTERNATIONAL 1000A</b>	5.0L V8 4982cc 304 CID	
	1984-1992	<b>DODGE B250</b>	5.9L V8 360 CID	1966	<b>INTERNATIONAL 1100A</b>	4.3L L6 4335cc 264 CID	
	1984-1992	<b>DODGE D250</b>	5.9L V8 360 CID	1966	<b>INTERNATIONAL 1100A</b>	4.3L V8 4360cc 266 CID	
	1984-1992	<b>DODGE RAMCHARGER</b>	5.9L V8 360 CID	1966	<b>INTERNATIONAL 1100A</b>	5.0L V8 304 CID	
	1984-1992	<b>DODGE W250</b>	5.9L V8 360 CID	1966	<b>INTERNATIONAL 1100A</b>	5.0L V8 4982cc 304 CID	
	1985	<b>DODGE DIPLOMAT</b>	5.2L V8 5211cc 318 CID	1966	<b>INTERNATIONAL 1100A</b>	5.0L V8 4983cc 304 CID	
	1985	<b>PLYMOUTH GRAN FURY</b>	5.2L V8 5211cc 318 CID	1966	<b>INTERNATIONAL 1200A</b>	4.3L L6 4335cc 264 CID	
	1985-1988	<b>DODGE D100</b>	5.9L V8 360 CID	1966	<b>INTERNATIONAL 1200A</b>	4.3L V8 4360cc 266 CID	
	1985-1989	<b>DODGE D100</b>	5.2L V8 5211cc 318 CID	1966	<b>INTERNATIONAL 1200A</b>	5.0L V8 304 CID	
	1986-1988	<b>DODGE W100</b>	5.9L V8 360 CID	1966	<b>INTERNATIONAL 1200A</b>	5.0L V8 4982cc 304 CID	
	1986-1989	<b>DODGE W100</b>	5.2L V8 5211cc 318 CID	1966	<b>INTERNATIONAL 1200A</b>	5.0L V8 4983cc 304 CID	
	1987-1991	<b>DODGE DAKOTA</b>	3.9L V6 3906cc 239 CID	1966	<b>INTERNATIONAL 1200A</b>	4.3L L6 4335cc 264 CID	
	1988-1989	<b>DODGE D100</b>	3.9L V6 3906cc 239 CID	1966	<b>INTERNATIONAL 1300A</b>	4.3L V8 4360cc 266 CID	
	1988-1991	<b>DODGE B150</b>	3.9L V6 3906cc 239 CID	1966	<b>INTERNATIONAL 1300A</b>	5.0L V8 4982cc 304 CID	
	1988-1991	<b>DODGE B250</b>	3.9L V6 3906cc 239 CID	1966-1967	<b>INTERNATIONAL 900A</b>	2.5L L4 2491cc 152 CID	
	1988-1991	<b>DODGE D150</b>	3.9L V6 3906cc 239 CID	1966-1967	<b>INTERNATIONAL M1400</b>	4.3L L6 4335cc 264 CID	
	1988-1991	<b>DODGE D250</b>	3.9L V6 3906cc 239 CID	1966-1967	<b>INTERNATIONAL M1400</b>	4.3L V8 4360cc 266 CID	
	1989	<b>DODGE DAKOTA</b>	5.2L V8 5211cc 318 CID	1966-1967	<b>INTERNATIONAL M1400</b>	5.0L V8 4982cc 304 CID	
	1989	<b>DODGE W100</b>	3.9L V6 3906cc 239 CID	1966-1970	<b>INTERNATIONAL M1100</b>	4.3L L6 4335cc 264 CID	
	1989-1991	<b>DODGE W150</b>	3.9L V6 3906cc 239 CID	1966-1970	<b>INTERNATIONAL M1100</b>	4.3L V8 4360cc 266 CID	
	<b>US1061</b>	1959-1964	<b>BUICK OPEL</b>	1.7L L4 1700cc 104 CID	1966-1970	<b>INTERNATIONAL M1200</b>	4.3L L6 4335cc 264 CID
		1965-1972	<b>BUICK OPEL</b>	2.1L L4 2100cc 128 CID	1966-1970	<b>INTERNATIONAL M1200</b>	4.3L V8 4360cc 266 CID
	<b>US1069</b>	1975-1976	<b>CHEVROLET MONZA</b>	4.3L V8 262 CID	1966-1971	<b>INTERNATIONAL M800</b>	2.5L L4 2491cc 152 CID
		1976-1979	<b>CHEVROLET MONZA</b>	5.0L V8 305 CID	1966-1971	<b>INTERNATIONAL M1100</b>	2.5L L4 2491cc 152 CID
		1977-1979	<b>OLDSMOBILE STARFIRE</b>	5.0L V8 305 CID	1966-1971	<b>INTERNATIONAL M1200</b>	2.5L L4 2491cc 152 CID
		1979	<b>PONTIAC PHOENIX</b>	5.0L V8 305 CID	1966-1971	<b>INTERNATIONAL SCOUT</b>	2.5L L4 2491cc 152 CID
		1979	<b>PONTIAC SUNBIRD</b>	5.0L V8 305 CID	1966-1972	<b>INTERNATIONAL M1100</b>	5.0L V8 4982cc 304 CID
<b>US1070</b>	1975	<b>FORD MUSTANG</b>	5.0L V8 5000cc 302 CID	1967	<b>INTERNATIONAL 908B</b>	4.3L V8 4360cc 266 CID	
	1975-1976	<b>FORD MUSTANG II</b>	5.0L V8 302 CID	1967	<b>INTERNATIONAL 908B</b>	5.0L V8 4982cc 304 CID	
<b>US1075</b>	1965-1967	<b>FORD F350</b>	5.0L V8 5000cc 302 CID	1967	<b>INTERNATIONAL 1000B</b>	4.3L L6 4335cc 264 CID	
	1965-1967	<b>FORD F350</b>	5.8L V8 5800cc 352 CID	1967	<b>INTERNATIONAL 1000B</b>	4.3L V8 4360cc 266 CID	
	1975-1976	<b>FORD F-100</b>	5.9L V8 360 CID	1967	<b>INTERNATIONAL 1000B</b>	5.0L V8 4982cc 304 CID	
	1975-1976	<b>FORD F-100</b>	6.4L V8 390 CID	1967	<b>INTERNATIONAL 1000B</b>	5.6L V8 5654cc 345 CID	
	1975-1976	<b>FORD F-150</b>	5.9L V8 360 CID	1967	<b>INTERNATIONAL 1100B</b>	4.3L L6 4335cc 264 CID	
	1975-1976	<b>FORD F-150</b>	6.4L V8 390 CID	1967	<b>INTERNATIONAL 1100B</b>	4.3L V8 4360cc 266 CID	
	1975-1976	<b>FORD F-250</b>	5.9L V8 360 CID	1967	<b>INTERNATIONAL 1100B</b>	5.0L V8 4982cc 304 CID	
	1975-1976	<b>FORD F-250</b>	6.4L V8 390 CID	1967	<b>INTERNATIONAL 1100B</b>	5.6L V8 5654cc 345 CID	
	1975-1976	<b>FORD F-350</b>	5.9L V8 360 CID	1967	<b>INTERNATIONAL 1200B</b>	4.3L L6 4335cc 264 CID	
	1975-1976	<b>FORD F-350</b>	6.4L V8 390 CID	1967	<b>INTERNATIONAL 1200B</b>	4.3L V8 4360cc 266 CID	
	1975-1976	<b>FORD F-100</b>	5.9L V8 360 CID	1967	<b>INTERNATIONAL 1200B</b>	5.0L V8 4982cc 304 CID	
	1975-1976	<b>FORD F-100</b>	6.4L V8 390 CID	1967	<b>INTERNATIONAL 1200B</b>	5.6L V8 5654cc 345 CID	
	1975-1976	<b>FORD F-150</b>	5.9L V8 360 CID	1967	<b>INTERNATIONAL 1300B</b>	4.3L L6 4335cc 264 CID	
	1975-1976	<b>FORD F-150</b>	6.4L V8 390 CID	1967	<b>INTERNATIONAL 1300B</b>	4.3L V8 4360cc 266 CID	
	1975-1976	<b>FORD F-250</b>	5.9L V8 360 CID	1967	<b>INTERNATIONAL 1300B</b>	5.0L V8 4982cc 304 CID	
<b>US1075H</b>	1975-1976	<b>FORD F-100</b>	5.9L V8 360 CID	1967	<b>INTERNATIONAL 1300B</b>	5.6L V8 5654cc 345 CID	
	1975-1976	<b>FORD F-100</b>	6.4L V8 390 CID	1967-1968	<b>INTERNATIONAL SCOUT</b>	4.3L V8 4360cc 266 CID	
	1975-1976	<b>FORD F-150</b>	5.9L V8 360 CID	1967-1970	<b>INTERNATIONAL MA1200</b>	4.3L V8 4360cc 266 CID	
	1975-1976	<b>FORD F-150</b>	6.4L V8 390 CID	1967-1971	<b>INTERNATIONAL MA1200</b>	5.0L V8 4982cc 304 CID	
	1975-1976	<b>FORD F-250</b>	5.9L V8 360 CID	1968	<b>INTERNATIONAL 1000C</b>	4.3L L6 4335cc 264 CID	
	1975-1976	<b>FORD F-250</b>	6.4L V8 390 CID	1968	<b>INTERNATIONAL 1000C</b>	4.3L V8 4360cc 266 CID	
	1975-1976	<b>FORD F-350</b>	5.9L V8 360 CID	1968	<b>INTERNATIONAL 1000C</b>	5.0L V8 4982cc 304 CID	
	1975-1976	<b>FORD F-350</b>	6.4L V8 390 CID	1968	<b>INTERNATIONAL 1000C</b>	5.6L V8 5654cc 345 CID	
	1975-1976	<b>FORD F-100</b>	5.9L V8 360 CID	1968	<b>INTERNATIONAL 1100C</b>	4.3L L6 4335cc 264 CID	
	1975-1976	<b>FORD F-100</b>	6.4L V8 390 CID	1968	<b>INTERNATIONAL 1100C</b>	4.3L V8 4360cc 266 CID	
	1975-1976	<b>FORD F-150</b>	5.9L V8 360 CID	1968	<b>INTERNATIONAL 1100C</b>	5.0L V8 4982cc 304 CID	
	1975-1976	<b>FORD F-150</b>	6.4L V8 390 CID	1968	<b>INTERNATIONAL 1100C</b>	5.6L V8 5654cc 345 CID	
	1975-1976	<b>FORD F-250</b>	5.9L V8 360 CID	1968	<b>INTERNATIONAL 1200C</b>	4.3L L6 4335cc 264 CID	
	1975-1976	<b>FORD F-250</b>	6.4L V8 390 CID	1968	<b>INTERNATIONAL 1200C</b>	4.3L V8 4360cc 266 CID	
	<b>US1077</b>	1973-1974	<b>JEEP CJ5D</b>	4.6L L6 4600cc 282 CID	1968	<b>INTERNATIONAL 1200C</b>	5.0L V8 4982cc 304 CID
1973-1979		<b>JEEP J364R</b>	4.6L L6 4600cc 282 CID	1968	<b>INTERNATIONAL 1200C</b>	5.6L V8 5654cc 345 CID	
1973-1983		<b>JEEP J164</b>	4.6L L6 4600cc 282 CID	1968	<b>INTERNATIONAL 1300C</b>	4.3L L6 4335cc 264 CID	
1973-1983		<b>JEEP J164V</b>	4.6L L6 4600cc 282 CID	1968	<b>INTERNATIONAL 1300C</b>	4.3L V8 4360cc 266 CID	
1974-1983		<b>JEEP CJ7</b>	4.6L L6 4600cc 282 CID	1968	<b>INTERNATIONAL 1300C</b>	5.0L V8 4982cc 304 CID	
1975		<b>AMERICAN MOTORS GREMLIN</b>	4.2L L6 4200cc 258 CID	1968	<b>INTERNATIONAL 1300C</b>	5.6L V8 5654cc 345 CID	
1975		<b>JEEP CJ7</b>	3.8L L6 3800cc 232 CID	1968-1969	<b>INTERNATIONAL 908C</b>	4.3L V8 4360cc 266 CID	
1975-1976		<b>AMERICAN MOTORS CLASSIC</b>	4.6L L6 4600cc 282 CID	1968-1969	<b>INTERNATIONAL 908C</b>	5.0L V8 4982cc 304 CID	
1975-1977		<b>AMERICAN MOTORS HORNET</b>	3.8L L6 232 CID	1968-1970	<b>INTERNATIONAL SCOUT</b>	2.5L L4 152 CID	
1975-1977		<b>AMERICAN MOTORS HORNET</b>	4.2L L6 258 CID	1968	<b>INTERNATIONAL 908C</b>	4.3L V8 4360cc 266 CID	
1975-1978		<b>AMERICAN MOTORS GREMLIN</b>	3.8L L6 232 CID	1969	<b>INTERNATIONAL 908C</b>	5.0L V8 4983cc 304 CID	
1975-1978		<b>AMERICAN MOTORS GREMLIN</b>	4.2L L6 258 CID	1969	<b>INTERNATIONAL M1400</b>	5.0L V8 304 CID	
1975-1978		<b>AMERICAN MOTORS MATADOR</b>	4.2L L6 258 CID	1969	<b>INTERNATIONAL M1400</b>	5.0L V8 4983cc 304 CID	
1975-1978		<b>AMERICAN MOTORS PACER</b>	3.8L L6 232 CID	1969-1970	<b>INTERNATIONAL 1000D</b>	4.3L L6 4335cc 264 CID	
1975-1978		<b>JEEP CJ7</b>	4.2L L6 4200cc 258 CID	1969-1970	<b>INTERNATIONAL 1000D</b>	4.3L V8 4360cc 266 CID	
1975-1979		<b>AMERICAN MOTORS AMERICAN</b>	4.6L L6 4600cc 282 CID	1969-1970	<b>INTERNATIONAL 1000D</b>	5.0L V8 304 CID	
1975-1979		<b>AMERICAN MOTORS PACER</b>	4.2L L6 258 CID	1969-1970	<b>INTERNATIONAL 1000D</b>	5.0L V8 4982cc 304 CID	
1975-1979		<b>AMERICAN MOTORS PACER</b>	4.6L L6 4600cc 282 CID	1969-1970	<b>INTERNATIONAL 1000D</b>	5.0L V8 4983cc 304 CID	
1975-1979		<b>JEEP CHEROKEE</b>	4.2L L6 258 CID				
1975-1979		<b>JEEP J10</b>	4.2L L6 258 CID				
1976		<b>JEEP J20</b>	4.2L L6 258 CID				
1976-1978		<b>JEEP CJ7</b>	3.8L L6 232 CID				
1976-1979		<b>JEEP CJ7</b>	4.2L L6 258 CID				
1976-1979		<b>JEEP WAGONEER</b>	4.6L L6 4600cc 282 CID				
1978-1979		<b>AMERICAN MOTORS AMERICAN</b>	4.2L L6 4200cc 258 CID				
1978-1979		<b>AMERICAN MOTORS AMX</b>	4.2L L6 258 CID				
1978-1979		<b>AMERICAN MOTORS CONCORD</b>	3.8L L6 232 CID				
1978-1979		<b>AMERICAN MOTORS CONCORD</b>	4.2L L6 258 CID				
1978-1983		<b>JEEP CJ5D</b>	4.6L L6 4600cc 282 CID				
1979		<b>AMERICAN MOTORS GREMLIN</b>	4.2L L6 4200cc 258 CID				
1979		<b>AMERICAN MOTORS GREMLIN</b>	4.6L L6 4600cc 282 CID				





USMW	Years	Application	Engine	USMW	Years	Application	Engine	
<b>US1100</b>	1977-1985	<b>OLDSMOBILE</b> CUSTOM CRUISER	5.7L V8 350 CID	<b>US1107</b>	1981-1983	<b>JEEP</b> SCRAMBLER	2.5L L4 151 CID	
	1978-1982	<b>OLDSMOBILE</b> CUTLASS CALAIS	4.3L V8 260 CID		1981-1984	<b>CHEVROLET</b> G30	4.1L L6 250 CID	
	1979-1980	<b>OLDSMOBILE</b> CUTLASS SALON	5.7L V8 350 CID		1982-1984	<b>CHEVROLET</b> CAMARO	2.5L L4 2474cc 151 CID	
	1979-1981	<b>OLDSMOBILE</b> TORONADO	5.7L V8 350 CID	1982-1984	<b>GMC</b> G3500	4.1L L6 250 CID		
	1979-1982	<b>OLDSMOBILE</b> CUTLASS CALAIS	5.7L V8 350 CID	1982-1984	<b>PONTIAC</b> FIREBIRD	2.5L L4 2474cc 151 CID		
	1980-1981	<b>OLDSMOBILE</b> 98	5.0L V8 307 CID	<b>US1109</b>	1975	<b>CHEVROLET</b> BEL AIR	6.6L V8 400 CID	
	1980-1981	<b>OLDSMOBILE</b> CUTLASS CRUISER	5.7L V8 350 CID		1975-1976	<b>CHEVROLET</b> C10	5.7L V8 350 CID	
	1980-1981	<b>OLDSMOBILE</b> CUTLASS SUPREME	5.7L V8 350 CID		1975-1976	<b>CHEVROLET</b> C10 SUBURBAN	5.7L V8 350 CID	
	1980-1981	<b>OLDSMOBILE</b> TORONADO	5.0L V8 307 CID		1975-1976	<b>CHEVROLET</b> C20	5.7L V8 350 CID	
	1980-1982	<b>OLDSMOBILE</b> CUTLASS CRUISER	4.3L V8 260 CID		1975-1976	<b>CHEVROLET</b> C20 SUBURBAN	5.7L V8 350 CID	
	1980-1982	<b>OLDSMOBILE</b> CUTLASS SUPREME	4.3L V8 260 CID		1975-1976	<b>CHEVROLET</b> C30	5.7L V8 350 CID	
	1980-1985	<b>BUICK</b> RIVIERA	5.0L V8 307 CID		1975-1976	<b>CHEVROLET</b> CAPRICE	6.6L V8 400 CID	
	1980-1985	<b>CHEVROLET</b> CAPRICE	5.7L V8 350 CID		1975-1976	<b>CHEVROLET</b> CS31003	5.7L V8 5700cc 350 CID	
	1980-1985	<b>CHEVROLET</b> IMPALA	5.7L V8 350 CID		1975-1976	<b>CHEVROLET</b> EL CAMINO	6.6L V8 400 CID	
	1980-1985	<b>OLDSMOBILE</b> CUSTOM CRUISER	5.0L V8 307 CID		1975-1976	<b>CHEVROLET</b> G10	5.7L V8 350 CID	
	1980-1985	<b>OLDSMOBILE</b> DELTA 88	5.0L V8 307 CID		1975-1976	<b>CHEVROLET</b> G20	5.7L V8 350 CID	
	1981	<b>BUICK</b> CENTURY	5.7L V8 350 CID		1975-1976	<b>CHEVROLET</b> G20	6.6L V8 400 CID	
	1981	<b>PONTIAC</b> BONNEVILLE	5.0L V8 307 CID		1975-1976	<b>CHEVROLET</b> G20	5.7L V8 350 CID	
	1981	<b>PONTIAC</b> CATALINA	5.0L V8 307 CID		1975-1976	<b>CHEVROLET</b> G30	6.6L V8 400 CID	
	1981-1983	<b>BUICK</b> ESTATE WAGON	5.0L V8 307 CID		1975-1976	<b>CHEVROLET</b> G30	6.6L V8 400 CID	
	1981-1983	<b>OLDSMOBILE</b> CUTLASS CRUISER	5.0L V8 307 CID		1975-1976	<b>CHEVROLET</b> IMPALA	6.6L V8 400 CID	
	1981-1984	<b>PONTIAC</b> GRAND PRIX	5.7L V8 350 CID		1975-1976	<b>CHEVROLET</b> K5 BLAZER	5.7L V8 350 CID	
	1981-1985	<b>BUICK</b> ELECTRA	5.0L V8 307 CID		1975-1976	<b>CHEVROLET</b> K5 BLAZER	6.6L V8 400 CID	
	1981-1985	<b>BUICK</b> LESABRE	5.0L V8 307 CID		1975-1976	<b>CHEVROLET</b> K10	5.7L V8 350 CID	
	1982-1983	<b>BUICK</b> REGAL	5.7L V8 350 CID		1975-1976	<b>CHEVROLET</b> K10	6.6L V8 400 CID	
	1982-1983	<b>CHEVROLET</b> MALIBU	5.7L V8 350 CID		1975-1976	<b>CHEVROLET</b> K10 SUBURBAN	5.7L V8 350 CID	
	1982-1984	<b>CHEVROLET</b> MONTE CARLO	5.7L V8 350 CID		1975-1976	<b>CHEVROLET</b> K10 SUBURBAN	6.6L V8 400 CID	
	1982-1984	<b>OLDSMOBILE</b> CUTLASS CALAIS	5.0L V8 307 CID		1975-1976	<b>CHEVROLET</b> K20	5.7L V8 350 CID	
	1982-1984	<b>OLDSMOBILE</b> CUTLASS SUPREME	5.0L V8 307 CID		1975-1976	<b>CHEVROLET</b> K20	6.6L V8 400 CID	
	1983	<b>OLDSMOBILE</b> CUTLASS CRUISER	5.7L V8 350 CID		1975-1976	<b>CHEVROLET</b> K20 SUBURBAN	5.7L V8 350 CID	
	1983-1984	<b>OLDSMOBILE</b> CUTLASS SUPREME	5.7L V8 350 CID		1975-1976	<b>CHEVROLET</b> K20 SUBURBAN	6.6L V8 400 CID	
	1985-1986	<b>OLDSMOBILE</b> CUTLASS SALON	5.0L V8 307 CID		1975-1976	<b>CHEVROLET</b> MALIBU	6.6L V8 400 CID	
	<b>US1107</b>	1975-1976	<b>OLDSMOBILE</b> CUTLASS		4.1L L6 250 CID	1975-1976	<b>CHEVROLET</b> MONTE CARLO	6.6L V8 400 CID
		1975-1976	<b>OLDSMOBILE</b> OMEGA		4.1L L6 250 CID	1975-1976	<b>CHEVROLET</b> P20	5.7L V8 350 CID
		1975-1976	<b>PONTIAC</b> FIREBIRD		4.1L L6 250 CID	1975-1976	<b>CHEVROLET</b> P30	5.7L V8 350 CID
		1975-1976	<b>PONTIAC</b> VENTURA		4.1L L6 250 CID	1975-1976	<b>GMC</b> C15	5.7L V8 350 CID
		1975-1977	<b>CHEVROLET</b> EL CAMINO		4.1L L6 250 CID	1975-1976	<b>GMC</b> C15 SUBURBAN	5.7L V8 350 CID
		1975-1977	<b>CHEVROLET</b> MALIBU		4.1L L6 250 CID	1975-1976	<b>GMC</b> C25	5.7L V8 350 CID
1975-1977		<b>PONTIAC</b> LEMANS	4.1L L6 250 CID		1975-1976	<b>GMC</b> C25 SUBURBAN	5.7L V8 350 CID	
1975-1979		<b>CHEVROLET</b> CAMARO	4.1L L6 250 CID		1975-1976	<b>GMC</b> G15	5.7L V8 350 CID	
1975-1979		<b>CHEVROLET</b> NOVA	4.1L L6 250 CID		1975-1976	<b>GMC</b> G25	5.7L V8 350 CID	
1975-1984		<b>CHEVROLET</b> C20	4.1L L6 250 CID	1975-1976	<b>GMC</b> G25	6.6L V8 400 CID		
1975-1984		<b>CHEVROLET</b> G20	4.1L L6 250 CID	1975-1976	<b>GMC</b> G35	5.7L V8 350 CID		
1977		<b>GMC</b> SPRINT	4.1L L6 250 CID	1975-1976	<b>GMC</b> G35	6.6L V8 400 CID		
1977		<b>PONTIAC</b> ASTRE	2.5L L4 2474cc 151 CID	1975-1976	<b>GMC</b> JIMMY	5.7L V8 350 CID		
1977		<b>PONTIAC</b> VENTURA	2.5L L4 2474cc 151 CID	1975-1976	<b>GMC</b> JIMMY	6.6L V8 400 CID		
1977-1978		<b>GMC</b> C25	4.1L L6 250 CID	1975-1976	<b>GMC</b> K15	5.7L V8 350 CID		
1977-1978		<b>PONTIAC</b> PHOENIX	2.5L L4 2474cc 151 CID	1975-1976	<b>GMC</b> K15	6.6L V8 400 CID		
1977-1979		<b>CHEVROLET</b> IMPALA	4.1L L6 250 CID	1975-1976	<b>GMC</b> K15 SUBURBAN	5.7L V8 350 CID		
1977-1980		<b>PONTIAC</b> SUNBIRD	2.5L L4 2474cc 151 CID	1975-1976	<b>GMC</b> K15 SUBURBAN	6.6L V8 400 CID		
1977-1984		<b>CHEVROLET</b> G10	4.1L L6 250 CID	1975-1976	<b>GMC</b> K25	5.7L V8 350 CID		
1978		<b>CHEVROLET</b> CS1073	4.1L L6 4100cc 250 CID	1975-1976	<b>GMC</b> K25	6.6L V8 400 CID		
1978		<b>GMC</b> C15	4.1L L6 250 CID	1975-1976	<b>GMC</b> K25 SUBURBAN	5.7L V8 350 CID		
1978		<b>GMC</b> C15 SUBURBAN	4.1L L6 250 CID	1975-1976	<b>GMC</b> K25 SUBURBAN	6.6L V8 400 CID		
1978		<b>GMC</b> G15	4.1L L6 250 CID	1975-1976	<b>GMC</b> P25	5.7L V8 350 CID		
1978		<b>GMC</b> G25	4.1L L6 250 CID	1975-1976	<b>GMC</b> P35	5.7L V8 350 CID		
1978		<b>GMC</b> K15	4.1L L6 250 CID	1976	<b>CHEVROLET</b> C10	6.6L V8 400 CID		
1978		<b>GMC</b> K15 SUBURBAN	4.1L L6 250 CID	1976	<b>CHEVROLET</b> C20	6.6L V8 400 CID		
1978-1979		<b>CHEVROLET</b> MALIBU	4.1L L6 4100cc 250 CID	1976	<b>CHEVROLET</b> C20 SUBURBAN	6.6L V8 400 CID		
1978-1980		<b>CHEVROLET</b> C10 SUBURBAN	4.1L L6 250 CID	1976	<b>CHEVROLET</b> C30	6.6L V8 400 CID		
1978-1980		<b>CHEVROLET</b> K10 SUBURBAN	4.1L L6 250 CID	1976	<b>CHEVROLET</b> CAMARO	5.0L V8 305 CID		
1978-1980		<b>CHEVROLET</b> MONZA	2.5L L4 2474cc 151 CID	1976	<b>CHEVROLET</b> CAMARO	5.7L V8 350 CID		
1978-1980		<b>OLDSMOBILE</b> STARFIRE	2.5L L4 2474cc 151 CID	1976	<b>CHEVROLET</b> CAPRICE	5.7L V8 350 CID		
1978-1982		<b>CHEVROLET</b> K5 BLAZER	4.1L L6 250 CID	1976	<b>CHEVROLET</b> EL CAMINO	5.0L V8 305 CID		
1978-1982		<b>GMC</b> JIMMY	4.1L L6 250 CID	1976	<b>CHEVROLET</b> EL CAMINO	5.7L V8 350 CID		
1978-1984		<b>CHEVROLET</b> C10	4.1L L6 250 CID	1976	<b>CHEVROLET</b> G10	6.6L V8 400 CID		
1978-1984		<b>CHEVROLET</b> K10	4.1L L6 250 CID	1976	<b>CHEVROLET</b> G10	6.6L V8 400 CID		
1979		<b>CHEVROLET</b> C10	4.1L L6 4097cc 250 CID	1976	<b>CHEVROLET</b> IMPALA	5.7L V8 350 CID		
1979		<b>CHEVROLET</b> MALIBU	4.1L L6 4097cc 250 CID	1976	<b>CHEVROLET</b> IMPALA	5.0L V8 305 CID		
1979		<b>GMC</b> G3500	4.1L L6 250 CID	1976	<b>CHEVROLET</b> MALIBU	5.0L V8 305 CID		
1979-1980		<b>GMC</b> C1500 SUBURBAN	4.1L L6 250 CID	1976	<b>CHEVROLET</b> MALIBU	5.7L V8 350 CID		
1979-1980		<b>GMC</b> K1500 SUBURBAN	4.1L L6 250 CID	1976	<b>CHEVROLET</b> MONTE CARLO	5.0L V8 305 CID		
1979-1984		<b>CHEVROLET</b> C10	4.1L L6 4100cc 250 CID	1976	<b>CHEVROLET</b> MONTE CARLO	5.7L V8 350 CID		
1979-1984		<b>GMC</b> C1500	4.1L L6 250 CID	1976	<b>CHEVROLET</b> NOVA	5.0L V8 305 CID		
1979-1984		<b>GMC</b> C2500	4.1L L6 250 CID	1976	<b>CHEVROLET</b> NOVA	5.7L V8 350 CID		
1979-1984		<b>GMC</b> G1500	4.1L L6 250 CID	1976	<b>CHEVROLET</b> P30	6.6L V8 400 CID		
1979-1984		<b>GMC</b> G2500	4.1L L6 250 CID	1976	<b>GMC</b> C15	6.6L V8 400 CID		
1979-1984		<b>GMC</b> K1500	4.1L L6 250 CID	1976	<b>GMC</b> C25	6.6L V8 400 CID		
1980		<b>CHEVROLET</b> C30	4.1L L6 250 CID	1976	<b>GMC</b> G15	6.6L V8 400 CID		
1980		<b>CHEVROLET</b> K20	4.1L L6 250 CID	<b>US1109H</b>	1975	<b>CHEVROLET</b> BEL AIR	6.6L V8 400 CID	
1980		<b>GMC</b> C3500	4.1L L6 250 CID		1975-1976	<b>CHEVROLET</b> C10	5.7L V8 350 CID	
1980		<b>GMC</b> K2500	4.1L L6 250 CID		1975-1976	<b>CHEVROLET</b> C10 SUBURBAN	5.7L V8 350 CID	
1980		<b>JEEP</b> C.J5	2.5L L4 151 CID		1975-1976	<b>CHEVROLET</b> C20	5.7L V8 350 CID	
1980-1982		<b>AMERICAN MOTORS</b> CONCORD	2.5L L4 151 CID		1975-1976	<b>CHEVROLET</b> C20 SUBURBAN	5.7L V8 350 CID	
1980-1982		<b>AMERICAN MOTORS</b> SPIRIT	2.5L L4 151 CID		1975-1976	<b>CHEVROLET</b> C30	5.7L V8 350 CID	
1980-1983		<b>JEEP</b> C.J7	2.5L L4 151 CID		1975-1976	<b>CHEVROLET</b> CAPRICE	6.6L V8 400 CID	
1980-1984		<b>GMC</b> C1500	4.1L L6 4100cc 250 CID		1975-1976	<b>CHEVROLET</b> EL CAMINO	6.6L V8 400 CID	
1981		<b>CHEVROLET</b> MALIBU	4.1L L6 4100cc 250 CID		1975-1976	<b>CHEVROLET</b> EL CAMINO	5.7L V8 350 CID	
1981-1983		<b>AMERICAN MOTORS</b> EAGLE	2.5L L4 151 CID		1975-1976	<b>CHEVROLET</b> G10	5.7L V8 350 CID	
					1975-1976	<b>CHEVROLET</b> G20	5.7L V8 350 CID	
			1975-1976		<b>CHEVROLET</b> G20	6.6L V8 400 CID		
			1975-1976		<b>CHEVROLET</b> G30	5.7L V8 350 CID		
			1975-1976		<b>CHEVROLET</b> G30	6.6L V8 400 CID		

USMW	Years	Application	Engine	USMW	Years	Application	Engine	
<b>US1109H</b>	1975-1976	CHEVROLET IMPALA	6.6L V8 400 CID	<b>US1114</b>	1977-1987	FORD E-350 ECONOLINE CLUB WAGON	7.5L V8 460 CID	
	1975-1976	CHEVROLET K5 BLAZER	5.7L V8 350 CID		1979	FORD F-100	7.5L V8 460 CID	
	1975-1976	CHEVROLET K5 BLAZER	6.6L V8 400 CID		1983-1987	FORD F-250	7.5L V8 460 CID	
	1975-1976	CHEVROLET K10	5.7L V8 350 CID		1983-1987	FORD F-350	7.5L V8 460 CID	
	1975-1976	CHEVROLET K10	6.6L V8 400 CID		1990-1991	FORD E-250 ECONOLINE CLUB WAGON	7.5L V8 460 CID	
	1975-1976	CHEVROLET K10 SUBURBAN	5.7L V8 350 CID		1990-1992	FORD E-350 ECONOLINE	7.5L V8 460 CID	
	1975-1976	CHEVROLET K10 SUBURBAN	6.6L V8 400 CID		1990-1992	FORD E-350 ECONOLINE CLUB WAGON	7.5L V8 460 CID	
	1975-1976	CHEVROLET K20	5.7L V8 350 CID		1990-1992	FORD F-250	7.5L V8 460 CID	
	1975-1976	CHEVROLET K20	6.6L V8 400 CID		1990-1992	FORD F-350	7.5L V8 460 CID	
	1975-1976	CHEVROLET K20 SUBURBAN	5.7L V8 350 CID		1990-1992	FORD F SUPER DUTY	7.5L V8 460 CID	
	1975-1976	CHEVROLET K20 SUBURBAN	6.6L V8 400 CID		<b>US1120</b>	1975	BUICK APOLLO	4.3L V8 260 CID
	1975-1976	CHEVROLET MALIBU	6.6L V8 400 CID			1975	BUICK APOLLO	5.7L V8 350 CID
	1975-1976	CHEVROLET MONTE CARLO	6.6L V8 400 CID			1975	BUICK LESABRE	6.6L V8 400 CID
	1975-1976	CHEVROLET P20	5.7L V8 350 CID			1975	OLDSMOBILE 98	6.6L V8 400 CID
	1975-1976	CHEVROLET P30	5.7L V8 350 CID			1975	OLDSMOBILE CUSTOM CRUISER	6.6L V8 400 CID
	1975-1976	GMC C15	5.7L V8 350 CID			1975	OLDSMOBILE DELTA 88	6.6L V8 400 CID
	1975-1976	GMC C15 SUBURBAN	5.7L V8 350 CID			1975-1976	BUICK SKYLARK	4.3L V8 260 CID
	1975-1976	GMC C25	5.7L V8 350 CID			1975-1976	OLDSMOBILE 98	7.5L V8 455 CID
	1975-1976	GMC C25 SUBURBAN	5.7L V8 350 CID			1975-1976	OLDSMOBILE CUSTOM CRUISER	7.5L V8 455 CID
	1975-1976	GMC G15	5.7L V8 350 CID	1975-1976		OLDSMOBILE CUTLASS	7.5L V8 455 CID	
	1975-1976	GMC G25	5.7L V8 350 CID	1975-1976		OLDSMOBILE CUTLASS SALON	7.5L V8 455 CID	
	1975-1976	GMC G25	6.6L V8 400 CID	1975-1976		OLDSMOBILE DELTA 88	7.5L V8 455 CID	
	1975-1976	GMC G35	5.7L V8 350 CID	1975-1976		OLDSMOBILE TORONADO	7.5L V8 455 CID	
	1975-1976	GMC G35	6.6L V8 400 CID	1975-1976		PONTIAC VENTURA	4.3L V8 260 CID	
	1975-1976	GMC JIMMY	5.7L V8 350 CID	1975-1977		BUICK REGAL	5.7L V8 350 CID	
	1975-1976	GMC JIMMY	6.6L V8 400 CID	1975-1977		BUICK SKYLARK	5.7L V8 350 CID	
	1975-1976	GMC K15	5.7L V8 350 CID	1975-1977		OLDSMOBILE CUTLASS SALON	5.7L V8 350 CID	
	1975-1976	GMC K15 SUBURBAN	6.6L V8 400 CID	1975-1977	OLDSMOBILE OMEGA	4.3L V8 260 CID		
	1975-1976	GMC K15 SUBURBAN	5.7L V8 350 CID	1975-1977	PONTIAC GRAND PRIX	6.6L V8 400 CID		
	1975-1976	GMC K25	6.6L V8 400 CID	1975-1977	PONTIAC LEMANS	6.6L V8 400 CID		
	1975-1976	GMC K25	5.7L V8 350 CID	1975-1978	PONTIAC BONNEVILLE	6.6L V8 400 CID		
	1975-1976	GMC K25 SUBURBAN	6.6L V8 400 CID	1975-1978	PONTIAC CATALINA	6.6L V8 400 CID		
	1975-1976	GMC K25 SUBURBAN	5.7L V8 350 CID	1975-1978	PONTIAC FIREBIRD	5.7L V8 350 CID		
	1975-1976	GMC P25	5.7L V8 350 CID	1975-1978	PONTIAC GRAND SAFARI	6.6L V8 400 CID		
	1975-1976	GMC P35	5.7L V8 350 CID	1975-1979	BUICK CENTURY	5.7L V8 350 CID		
	1976	CHEVROLET C10	6.6L V8 400 CID	1975-1979	OLDSMOBILE OMEGA	5.7L V8 350 CID		
	1976	CHEVROLET C20	6.6L V8 400 CID	1975-1979	PONTIAC FIREBIRD	6.6L V8 400 CID		
	1976	CHEVROLET C20 SUBURBAN	6.6L V8 400 CID	1975-1979	PONTIAC LEMANS	5.7L V8 350 CID		
	1976	CHEVROLET C30	6.6L V8 400 CID	1975-1980	OLDSMOBILE CUTLASS SALON	4.3L V8 260 CID		
	1976	CHEVROLET CAMARO	5.0L V8 305 CID	1975-1981	OLDSMOBILE CUTLASS	4.3L V8 260 CID		
	1976	CHEVROLET CAMARO	5.7L V8 350 CID	1975-1981	OLDSMOBILE CUTLASS	5.7L V8 350 CID		
	1976	CHEVROLET CAPRICE	5.7L V8 350 CID	1975-1985	BUICK LESABRE	5.7L V8 350 CID		
	1976	CHEVROLET EL CAMINO	5.0L V8 305 CID	1975-1985	OLDSMOBILE DELTA 88	5.7L V8 350 CID		
1976	CHEVROLET EL CAMINO	5.7L V8 350 CID	1976	OLDSMOBILE CUTLASS TIARA	4.3L V8 260 CID			
1976	CHEVROLET G10	6.6L V8 400 CID	1976	OLDSMOBILE CUTLASS TIARA	5.7L V8 455 CID			
1976	CHEVROLET IMPALA	5.7L V8 350 CID	1976	PONTIAC LEMANS	4.3L V8 260 CID			
1976	CHEVROLET MALIBU	5.0L V8 305 CID	1976	PONTIAC GRAND PRIX	5.7L V8 350 CID			
1976	CHEVROLET MALIBU	5.7L V8 350 CID	1976-1977	PONTIAC CATALINA	5.7L V8 350 CID			
1976	CHEVROLET MONTE CARLO	5.0L V8 305 CID	1976-1981	BUICK ELECTRA	5.7L V8 350 CID			
1976	CHEVROLET MONTE CARLO	5.7L V8 350 CID	1976-1985	BUICK CENTURY	6.6L V8 403 CID			
1976	CHEVROLET NOVA	5.0L V8 305 CID	1977	OLDSMOBILE CUTLASS	6.6L V8 403 CID			
1976	CHEVROLET NOVA	5.7L V8 350 CID	1977	OLDSMOBILE CUTLASS SALON	6.6L V8 403 CID			
1976	CHEVROLET P30	6.6L V8 400 CID	1977	PONTIAC GRAND PRIX	6.6L V8 403 CID			
1976	GMC C15	6.6L V8 400 CID	1977	PONTIAC GRAND SAFARI	5.7L V8 350 CID			
1976	GMC C25	6.6L V8 400 CID	1977	PONTIAC LEMANS	6.6L V8 403 CID			
1976	GMC G15	6.6L V8 400 CID	1977	PONTIAC VENTURA	5.7L V8 350 CID			
<b>US1110</b>	1975-1976	CHEVROLET G10	4.1L L6 250 CID	1977-1978	BUICK LESABRE	6.6L V8 403 CID		
	1975-1976	CHEVROLET IMPALA	4.1L L6 4100cc 250 CID	1977-1978	BUICK RIVIERA	6.6L V8 403 CID		
	1975-1977	CHEVROLET C10	4.1L L6 250 CID	1977-1978	OLDSMOBILE TORONADO	6.6L V8 403 CID		
	1975-1977	CHEVROLET C10 SUBURBAN	4.1L L6 250 CID	1977-1978	PONTIAC GRAND SAFARI	6.6L V8 403 CID		
	1975-1977	CHEVROLET CS1073	4.1L L6 4100cc 250 CID	1977-1979	BUICK ELECTRA	6.6L V8 403 CID		
	1975-1977	CHEVROLET K5 BLAZER	4.1L L6 250 CID	1977-1979	BUICK ESTATE WAGON	6.6L V8 403 CID		
	1975-1977	CHEVROLET K10	4.1L L6 250 CID	1977-1979	OLDSMOBILE 98	6.6L V8 403 CID		
	1975-1977	CHEVROLET K10 SUBURBAN	4.1L L6 250 CID	1977-1979	OLDSMOBILE CUSTOM CRUISER	6.6L V8 403 CID		
	1975-1977	GMC C15	4.1L L6 250 CID	1977-1979	OLDSMOBILE DELTA 88	6.6L V8 403 CID		
	1975-1977	GMC C15 SUBURBAN	4.1L L6 250 CID	1977-1979	PONTIAC BONNEVILLE	6.6L V8 403 CID		
	1975-1977	GMC G15	4.1L L6 250 CID	1977-1979	PONTIAC CATALINA	6.6L V8 403 CID		
	1975-1977	GMC JIMMY	4.1L L6 250 CID	1977-1979	PONTIAC FIREBIRD	6.6L V8 403 CID		
	1975-1977	GMC K15	4.1L L6 250 CID	1977-1979	PONTIAC PHOENIX	5.7L V8 350 CID		
	1975-1977	GMC K15 SUBURBAN	4.1L L6 250 CID	1977-1982	OLDSMOBILE DELTA 88	4.3L V8 260 CID		
	<b>US1114</b>	1975-1976	FORD CUSTOM 500	7.5L V8 460 CID	1977-1983	BUICK ESTATE WAGON	5.7L V8 350 CID	
		1975-1976	FORD ELITE	7.5L V8 460 CID	1977-1984	OLDSMOBILE 98	5.7L V8 350 CID	
		1975-1976	FORD THUNDERBIRD	7.5L V8 460 CID	1977-1984	PONTIAC BONNEVILLE	5.7L V8 350 CID	
		1975-1976	FORD TORINO	7.5L V8 460 CID	1977-1985	BUICK RIVIERA	5.7L V8 350 CID	
		1975-1976	LINCOLN MARK IV	7.5L V8 460 CID	1977-1985	OLDSMOBILE CUSTOM CRUISER	5.7L V8 350 CID	
		1975-1976	MERCURY COUGAR	7.5L V8 460 CID	1978-1980	OLDSMOBILE CUTLASS CALAIS	4.3L V8 260 CID	
		1975-1976	MERCURY MONTEGO	7.5L V8 460 CID	1979-1980	OLDSMOBILE CUTLASS SALON	5.7L V8 350 CID	
		1975-1977	FORD RANCHERO	7.5L V8 460 CID	1979-1984	OLDSMOBILE CUTLASS CALAIS	5.7L V8 350 CID	
		1975-1978	FORD LTD	7.5L V8 460 CID	1979-1985	OLDSMOBILE TORONADO	5.7L V8 350 CID	
		1975-1978	LINCOLN CONTINENTAL	7.5L V8 460 CID	1980-1983	OLDSMOBILE CUTLASS CRUISER	5.7L V8 350 CID	
		1975-1978	MERCURY MARQUIS	7.5L V8 460 CID	1980-1984	CADILLAC DEVILLE	5.7L V8 350 CID	
1975-1979		FORD F-150	7.5L V8 460 CID	1980-1984	OLDSMOBILE 98	5.0L V8 307 CID		
1975-1979		FORD F-250	7.5L V8 460 CID	1980-1985	BUICK RIVIERA	5.0L V8 307 CID		
1975-1979		FORD F-350	7.5L V8 460 CID	1980-1985	CADILLAC ELDORADO	5.7L V8 350 CID		
1975-1980		FORD E-250 ECONOLINE	7.5L V8 460 CID	1980-1985	CADILLAC FLEETWOOD	5.7L V8 350 CID		
1975-1987		FORD E-250 ECONOLINE CLUB WAGON	7.5L V8 460 CID	1980-1985	CADILLAC SEVILLE	5.7L V8 350 CID		
1975-1987		FORD E-350 ECONOLINE	7.5L V8 460 CID					

WATER PUMPS

USMW	Years	Application	Engine	USMW	Years	Application	Engine	
<b>US1120</b>	1980-1985	CHEVROLET CAPRICE	5.7L V8 350 CID	<b>US1120H</b>	1977-1979	PONTIAC BONNEVILLE	6.6L V8 403 CID	
	1980-1985	CHEVROLET IMPALA	5.7L V8 350 CID		1977-1979	PONTIAC CATALINA	6.6L V8 403 CID	
	1980-1985	OLDSMOBILE CUTLASS SUPREME	5.7L V8 350 CID		1977-1979	PONTIAC FIREBIRD	6.6L V8 403 CID	
	1980-1985	OLDSMOBILE DELTA 88	5.0L V8 307 CID		1977-1979	PONTIAC PHOENIX	5.7L V8 350 CID	
	1980-1985	OLDSMOBILE TORONADO	5.0L V8 307 CID		1977-1982	OLDSMOBILE DELTA 88	4.3L V8 260 CID	
	1980-1990	OLDSMOBILE CUSTOM CRUISER	5.0L V8 307 CID		1977-1983	BUICK ESTATE WAGON	5.7L V8 350 CID	
	1981	BUICK CENTURY	5.7L V8 350 CID		1977-1984	OLDSMOBILE 98	5.7L V8 350 CID	
	1981	PONTIAC BONNEVILLE	5.0L V8 307 CID		1977-1984	PONTIAC BONNEVILLE	5.7L V8 350 CID	
	1981	PONTIAC CATALINA	5.0L V8 307 CID		1977-1985	BUICK RIVIERA	5.7L V8 350 CID	
	1981-1983	BUICK ESTATE WAGON	5.0L V8 307 CID		1977-1985	OLDSMOBILE CUSTOM CRUISER	5.7L V8 350 CID	
	1981-1984	PONTIAC GRAND PRIX	5.7L V8 350 CID		1978-1980	OLDSMOBILE CUTLASS CALAIS	4.3L V8 260 CID	
	1981-1989	BUICK ELECTRA	5.0L V8 307 CID		1979-1980	OLDSMOBILE CUTLASS SALON	5.7L V8 350 CID	
	1981-1990	BUICK LESABRE	5.0L V8 307 CID		1979-1984	OLDSMOBILE CUTLASS CALAIS	5.7L V8 350 CID	
	1982	OLDSMOBILE CUTLASS CALAIS	4.3L V8 260 CID		1979-1985	OLDSMOBILE TORONADO	5.7L V8 350 CID	
	1982-1983	BUICK REGAL	5.7L V8 350 CID		1980-1983	OLDSMOBILE CUTLASS CRUISER	5.7L V8 350 CID	
	1982-1983	CHEVROLET MALIBU	5.7L V8 350 CID		1980-1984	CADILLAC DEVILLE	5.7L V8 350 CID	
	1982-1983	OLDSMOBILE CUTLASS CRUISER	5.0L V8 307 CID		1980-1984	OLDSMOBILE 98	5.0L V8 307 CID	
	1982-1983	OLDSMOBILE CUTLASS SUPREME	4.3L V6 260 CID		1980-1985	BUICK RIVIERA	5.0L V8 307 CID	
	1982-1984	CHEVROLET MONTE CARLO	5.7L V8 350 CID		1980-1985	CADILLAC ELDORADO	5.7L V8 350 CID	
	1982-1984	OLDSMOBILE CUTLASS CALAIS	5.0L V8 307 CID		1980-1985	CADILLAC FLEETWOOD	5.7L V8 350 CID	
	1982-1988	OLDSMOBILE CUTLASS SUPREME	5.0L V8 307 CID		1980-1985	CADILLAC SEVILLE	5.7L V8 350 CID	
	1983-1984	CHEVROLET EL CAMINO	5.7L V8 350 CID		1980-1985	CHEVROLET CAPRICE	5.7L V8 350 CID	
	1983-1984	GMC CABALLERO	5.7L V8 350 CID		1980-1985	CHEVROLET IMPALA	5.7L V8 350 CID	
	1983-1985	PONTIAC PARISIENNE	5.7L V8 350 CID		1980-1985	OLDSMOBILE CUTLASS SUPREME	5.7L V8 350 CID	
	1985	BUICK REGAL	5.7L V8 350 CID		1980-1985	OLDSMOBILE DELTA 88	5.0L V8 307 CID	
	1985	OLDSMOBILE CUTLASS SALON	5.7L V8 350 CID		1980-1985	OLDSMOBILE TORONADO	5.0L V8 307 CID	
	1985-1987	OLDSMOBILE CUTLASS SALON	5.0L V8 307 CID		1980-1990	OLDSMOBILE CUSTOM CRUISER	5.0L V8 307 CID	
	1986	CADILLAC FLEETWOOD	5.0L V8 307 CID		1981	BUICK CENTURY	5.7L V8 350 CID	
	1986	PONTIAC PARISIENNE	5.0L V8 307 CID		1981	PONTIAC BONNEVILLE	5.0L V8 307 CID	
	1986-1987	BUICK REGAL	5.0L V8 307 CID		1981	PONTIAC CATALINA	5.0L V8 307 CID	
	1986-1990	CHEVROLET CAPRICE	5.0L V8 307 CID		1981-1983	BUICK ESTATE WAGON	5.0L V8 307 CID	
	1987-1989	PONTIAC SAFARI	5.0L V8 307 CID		1981-1984	PONTIAC GRAND PRIX	5.7L V8 350 CID	
	1987-1990	CADILLAC BROUGHAM	5.0L V8 307 CID		1981-1989	BUICK ELECTRA	5.0L V8 307 CID	
	<b>US1120H</b>	1975	BUICK APOLLO		4.3L V8 260 CID	1981-1990	BUICK LESABRE	5.0L V8 307 CID
		1975	BUICK APOLLO		5.7L V8 350 CID	1982	OLDSMOBILE CUTLASS CALAIS	4.3L V8 260 CID
		1975	BUICK LESABRE		6.6L V8 400 CID	1982-1983	BUICK REGAL	5.7L V8 350 CID
		1975	OLDSMOBILE 98		6.6L V8 400 CID	1982-1983	CHEVROLET MALIBU	5.7L V8 350 CID
		1975	OLDSMOBILE CUSTOM CRUISER		6.6L V8 400 CID	1982-1983	OLDSMOBILE CUTLASS CRUISER	5.0L V8 307 CID
		1975	OLDSMOBILE DELTA 88		6.6L V8 400 CID	1982-1983	OLDSMOBILE CUTLASS SUPREME	4.3L V6 260 CID
		1975-1976	BUICK SKYLARK		4.3L V8 260 CID	1982-1984	CHEVROLET MONTE CARLO	5.7L V8 350 CID
1975-1976		OLDSMOBILE 98	7.5L V8 455 CID	1982-1984	OLDSMOBILE CUTLASS CALAIS	5.0L V8 307 CID		
1975-1976		OLDSMOBILE CUSTOM CRUISER	7.5L V8 455 CID	1982-1988	OLDSMOBILE CUTLASS SUPREME	5.0L V8 307 CID		
1975-1976		OLDSMOBILE CUTLASS	7.5L V8 455 CID	1983-1984	CHEVROLET EL CAMINO	5.7L V8 350 CID		
1975-1976		OLDSMOBILE CUTLASS SALON	7.5L V8 455 CID	1983-1984	GMC CABALLERO	5.7L V8 350 CID		
1975-1976		OLDSMOBILE DELTA 88	7.5L V8 455 CID	1983-1985	PONTIAC PARISIENNE	5.7L V8 350 CID		
1975-1976		OLDSMOBILE TORONADO	7.5L V8 455 CID	1985	BUICK REGAL	5.7L V8 350 CID		
1975-1976		PONTIAC VENTURA	4.3L V8 260 CID	1985	OLDSMOBILE CUTLASS SALON	5.7L V8 350 CID		
1975-1977		BUICK REGAL	5.7L V8 350 CID	1985-1987	OLDSMOBILE CUTLASS SALON	5.0L V8 307 CID		
1975-1977		BUICK SKYLARK	5.7L V8 350 CID	1986	CADILLAC FLEETWOOD	5.0L V8 307 CID		
1975-1977		OLDSMOBILE CUTLASS SALON	5.7L V8 350 CID	1986	PONTIAC PARISIENNE	5.0L V8 307 CID		
1975-1977		OLDSMOBILE OMEGA	4.3L V8 260 CID	1986-1987	BUICK REGAL	5.0L V8 307 CID		
1975-1977		PONTIAC GRAND PRIX	6.6L V8 400 CID	1986-1990	CHEVROLET CAPRICE	5.0L V8 307 CID		
1975-1977		PONTIAC LEMANS	6.6L V8 400 CID	1987-1989	PONTIAC SAFARI	5.0L V8 307 CID		
1975-1978		PONTIAC BONNEVILLE	6.6L V8 400 CID	1987-1990	CADILLAC BROUGHAM	5.0L V8 307 CID		
1975-1978		PONTIAC CATALINA	6.6L V8 400 CID	<b>US1121</b>	1977	CHEVROLET MONTE CARLO	5.7L V8 350 CID	
1975-1978		PONTIAC FIREBIRD	5.7L V8 350 CID		1977	GMC SPRINT	5.0L V8 305 CID	
1975-1978		PONTIAC GRAND SAFARI	6.6L V8 400 CID		1977	GMC SPRINT	5.7L V8 350 CID	
1975-1979		BUICK CENTURY	5.7L V8 350 CID		1977	PONTIAC VENTURA	5.0L V8 305 CID	
1975-1979		OLDSMOBILE OMEGA	5.7L V8 350 CID		1977-1978	CHEVROLET CS31003	5.7L V8 5700cc 350 CID	
1975-1979		PONTIAC FIREBIRD	6.6L V8 400 CID		1977-1978	CHEVROLET K20	5.0L V8 305 CID	
1975-1979		PONTIAC LEMANS	5.7L V8 350 CID		1977-1978	CHEVROLET K20 SUBURBAN	5.0L V8 305 CID	
1975-1980		OLDSMOBILE CUTLASS SALON	4.3L V8 260 CID		1977-1978	GMC C15	5.0L V8 305 CID	
1975-1981		OLDSMOBILE CUTLASS	4.3L V8 260 CID		1977-1978	GMC C15	5.7L V8 350 CID	
1975-1981		OLDSMOBILE CUTLASS	5.7L V8 350 CID		1977-1978	GMC C15 SUBURBAN	5.0L V8 305 CID	
1975-1985		BUICK LESABRE	5.7L V8 350 CID		1977-1978	GMC C15 SUBURBAN	5.7L V8 350 CID	
1975-1985		OLDSMOBILE DELTA 88	5.7L V8 350 CID		1977-1978	GMC C25	5.0L V8 305 CID	
1976		OLDSMOBILE CUTLASS TIARA	4.3L V8 260 CID		1977-1978	GMC C25	5.7L V8 350 CID	
1976		OLDSMOBILE CUTLASS TIARA	5.7L V8 350 CID		1977-1978	GMC C25	6.6L V8 400 CID	
1976		OLDSMOBILE CUTLASS TIARA	7.5L V8 455 CID		1977-1978	GMC C25 SUBURBAN	5.0L V8 305 CID	
1976		PONTIAC LEMANS	4.3L V8 260 CID		1977-1978	GMC C25 SUBURBAN	5.7L V8 350 CID	
1976-1977		PONTIAC GRAND PRIX	5.7L V8 350 CID		1977-1978	GMC G15	5.0L V8 305 CID	
1976-1981		PONTIAC CATALINA	5.7L V8 350 CID		1977-1978	GMC G15	5.7L V8 350 CID	
1976-1985		BUICK ELECTRA	5.7L V8 350 CID		1977-1978	GMC G25	5.0L V8 305 CID	
1977	BUICK CENTURY	6.6L V8 403 CID	1977-1978		GMC G25	5.7L V8 350 CID		
1977	OLDSMOBILE CUTLASS	6.6L V8 403 CID	1977-1978		GMC G25	6.6L V8 400 CID		
1977	OLDSMOBILE CUTLASS SALON	6.6L V8 403 CID	1977-1978		GMC G35	5.7L V8 350 CID		
1977	PONTIAC GRAND PRIX	6.6L V8 403 CID	1977-1978		GMC G35	6.6L V8 400 CID		
1977	PONTIAC GRAND SAFARI	5.7L V8 350 CID	1977-1978		GMC K15	5.0L V8 305 CID		
1977	PONTIAC LEMANS	6.6L V8 403 CID	1977-1978		GMC K15	5.7L V8 350 CID		
1977	PONTIAC VENTURA	5.7L V8 350 CID	1977-1978		GMC K15	6.6L V8 400 CID		
1977-1978	BUICK LESABRE	6.6L V8 403 CID	1977-1978		GMC K15 SUBURBAN	5.0L V8 305 CID		
1977-1978	BUICK RIVIERA	6.6L V8 403 CID	1977-1978		GMC K15 SUBURBAN	5.7L V8 350 CID		
1977-1978	OLDSMOBILE TORONADO	6.6L V8 403 CID	1977-1978		GMC K15 SUBURBAN	6.6L V8 400 CID		
1977-1978	PONTIAC GRAND SAFARI	6.6L V8 403 CID	1977-1978		GMC K25	5.0L V8 305 CID		
1977-1979	BUICK ELECTRA	6.6L V8 403 CID	1977-1978		GMC K25	5.7L V8 350 CID		
1977-1979	BUICK ESTATE WAGON	6.6L V8 403 CID	1977-1978		GMC K25	6.6L V8 400 CID		
1977-1979	OLDSMOBILE 98	6.6L V8 403 CID	1977-1978		GMC K25 SUBURBAN	5.0L V8 305 CID		
1977-1979	OLDSMOBILE CUSTOM CRUISER	6.6L V8 403 CID	1977-1978		GMC K25 SUBURBAN	5.7L V8 350 CID		
1977-1979	OLDSMOBILE DELTA 88	6.6L V8 403 CID	1977-1978		GMC K25 SUBURBAN	6.6L V8 400 CID		



USMW	Years	Application	Engine	USMW	Years	Application	Engine
<b>US1121</b>	1977-1978	<b>GMC K35</b>	5.7L V8 350 CID	<b>US1121</b>	1979-1980	<b>GMC K2500</b>	6.6L V8 400 CID
	1977-1978	<b>GMC K35</b>	6.6L V8 400 CID		1979-1980	<b>GMC K2500 SUBURBAN</b>	6.6L V8 400 CID
	1977-1978	<b>GMC P25</b>	5.7L V8 350 CID		1979-1980	<b>GMC K3500</b>	6.6L V8 400 CID
	1977-1978	<b>GMC P35</b>	5.7L V8 350 CID		1979-1981	<b>CHEVROLET MALIBU</b>	5.7L V8 350cc 350 CID
	1977-1978	<b>PONTIAC PHOENIX</b>	5.0L V8 305 CID		1979-1985	<b>CHEVROLET C30</b>	5.7L V8 5700cc 350 CID
	1977-1978	<b>PONTIAC PHOENIX</b>	5.7L V8 350 CID		1979-1986	<b>GMC C1500</b>	5.0L V8 305 CID
	1977-1979	<b>BUICK SKYLARK</b>	5.0L V8 305 CID		1979-1986	<b>GMC C1500</b>	5.7L V8 350 CID
	1977-1979	<b>CHEVROLET C30</b>	6.6L V8 400 CID		1979-1986	<b>GMC C1500 SUBURBAN</b>	5.0L V8 305 CID
	1977-1979	<b>CHEVROLET EL CAMINO</b>	5.7L V8 350 CID		1979-1986	<b>GMC C1500 SUBURBAN</b>	5.7L V8 350 CID
	1977-1979	<b>CHEVROLET K5 BLAZER</b>	6.6L V8 400 CID		1979-1986	<b>GMC C2500</b>	5.0L V8 305 CID
	1977-1979	<b>CHEVROLET K10</b>	5.0L V8 305 CID		1979-1986	<b>GMC C2500</b>	5.7L V8 350 CID
	1977-1979	<b>CHEVROLET K10 SUBURBAN</b>	6.6L V8 400 CID		1979-1986	<b>GMC C2500 SUBURBAN</b>	5.7L V8 350 CID
	1977-1979	<b>CHEVROLET NOVA</b>	5.0L V8 305 CID		1979-1986	<b>GMC G1500</b>	5.0L V8 305 CID
	1977-1979	<b>CHEVROLET NOVA</b>	5.7L V8 350 CID		1979-1986	<b>GMC G1500</b>	5.7L V8 350 CID
	1977-1979	<b>GMC JIMMY</b>	6.6L V8 400 CID		1979-1986	<b>GMC G2500</b>	5.0L V8 305 CID
	1977-1980	<b>BUICK CENTURY</b>	5.0L V8 305 CID		1979-1986	<b>GMC G2500</b>	5.7L V8 350 CID
	1977-1980	<b>BUICK REGAL</b>	5.0L V8 305 CID		1979-1986	<b>GMC K1500</b>	5.7L V8 350 CID
	1977-1980	<b>CHEVROLET C10</b>	6.6L V8 400 CID		1979-1986	<b>GMC K1500 SUBURBAN</b>	5.7L V8 350 CID
	1977-1980	<b>CHEVROLET C20</b>	6.6L V8 400 CID		1979-1986	<b>GMC K2500</b>	5.7L V8 350 CID
	1977-1980	<b>CHEVROLET C20 SUBURBAN</b>	6.6L V8 400 CID		1979-1986	<b>GMC K2500 SUBURBAN</b>	5.7L V8 350 CID
	1977-1980	<b>CHEVROLET CAPRICE</b>	5.7L V8 350 CID		1979-1986	<b>GMC K3500</b>	5.7L V8 350 CID
	1977-1980	<b>CHEVROLET G20</b>	6.6L V8 400 CID		1979-1988	<b>GMC G3500</b>	5.7L V8 350 CID
	1977-1980	<b>CHEVROLET G30</b>	6.6L V8 400 CID		1979-1989	<b>GMC P2500</b>	5.7L V8 350 CID
	1977-1980	<b>CHEVROLET K10</b>	6.6L V8 400 CID		1979-1995	<b>GMC P3500</b>	5.7L V8 350 CID
	1977-1980	<b>CHEVROLET K20</b>	6.6L V8 400 CID		1980	<b>CHEVROLET K20</b>	5.0L V8 305 CID
	1977-1980	<b>CHEVROLET K20 SUBURBAN</b>	6.6L V8 400 CID		1980	<b>GMC C2500 SUBURBAN</b>	6.6L V8 400 CID
	1977-1980	<b>CHEVROLET K30</b>	6.6L V8 400 CID		1980	<b>OLDSMOBILE CUTLASS</b>	5.0L V8 305 CID
	1977-1980	<b>PONTIAC LEMANS</b>	5.0L V8 305 CID		1980	<b>OLDSMOBILE CUTLASS CALAIS</b>	5.0L V8 305 CID
	1977-1981	<b>CHEVROLET CAMARO</b>	5.7L V8 350 CID		1980	<b>OLDSMOBILE CUTLASS CRUISER</b>	5.0L V8 305 CID
	1977-1981	<b>CHEVROLET MALIBU</b>	5.7L V8 350 CID		1980	<b>OLDSMOBILE CUTLASS SALON</b>	5.0L V8 305 CID
	1977-1983	<b>CHEVROLET MALIBU</b>	5.0L V8 305 CID		1980	<b>OLDSMOBILE CUTLASS SUPREME</b>	5.0L V8 305 CID
	1977-1985	<b>CHEVROLET IMPALA</b>	5.0L V8 305 CID		1980	<b>PONTIAC GRAND LEMANS</b>	3.8L V6 229 CID
	1977-1985	<b>CHEVROLET IMPALA</b>	5.7L V8 350 CID		1980	<b>PONTIAC GRAND LEMANS</b>	5.0L V8 305 CID
	1977-1986	<b>CHEVROLET C10</b>	5.0L V8 305 CID		1980	<b>PONTIAC LEMANS</b>	3.8L V6 229 CID
	1977-1986	<b>CHEVROLET C10</b>	5.7L V8 350 CID		1980-1981	<b>CHEVROLET CAMARO</b>	3.8L V6 229 CID
	1977-1986	<b>CHEVROLET C10 SUBURBAN</b>	5.0L V8 305 CID		1980-1981	<b>CHEVROLET CAMARO</b>	4.4L V8 267 CID
	1977-1986	<b>CHEVROLET C10 SUBURBAN</b>	5.7L V8 350 CID		1980-1982	<b>CHEVROLET CAPRICE</b>	4.4L V8 267 CID
	1977-1986	<b>CHEVROLET C20</b>	5.0L V8 305 CID		1980-1982	<b>CHEVROLET EL CAMINO</b>	4.4L V8 267 CID
	1977-1986	<b>CHEVROLET C20</b>	5.7L V8 350 CID		1980-1982	<b>CHEVROLET IMPALA</b>	4.4L V8 267 CID
	1977-1986	<b>CHEVROLET C20 SUBURBAN</b>	5.0L V8 305 CID		1980-1982	<b>CHEVROLET MALIBU</b>	4.4L V8 267 CID
	1977-1986	<b>CHEVROLET C20 SUBURBAN</b>	5.7L V8 350 CID		1980-1982	<b>CHEVROLET MONTE CARLO</b>	4.4L V8 267 CID
	1977-1986	<b>CHEVROLET C30</b>	5.7L V8 350 CID		1980-1982	<b>GMC CABALLERO</b>	4.4L V8 267 CID
	1977-1986	<b>CHEVROLET G10</b>	5.0L V8 305 CID		1980-1983	<b>CHEVROLET MALIBU</b>	3.8L V6 229 CID
	1977-1986	<b>CHEVROLET G10</b>	5.7L V8 350 CID		1980-1984	<b>CHEVROLET CAPRICE</b>	3.8L V6 229 CID
	1977-1986	<b>CHEVROLET G20</b>	5.0L V8 305 CID		1980-1984	<b>CHEVROLET EL CAMINO</b>	3.8L V6 229 CID
	1977-1986	<b>CHEVROLET G20</b>	5.7L V8 350 CID		1980-1984	<b>CHEVROLET IMPALA</b>	3.8L V6 229 CID
	1977-1986	<b>CHEVROLET K5 BLAZER</b>	5.0L V8 305 CID		1980-1984	<b>CHEVROLET MONTE CARLO</b>	3.8L V6 229 CID
	1977-1986	<b>CHEVROLET K5 BLAZER</b>	5.7L V8 350 CID		1980-1984	<b>GMC CABALLERO</b>	3.8L V6 229 CID
	1977-1986	<b>CHEVROLET K10</b>	5.7L V8 350 CID		1980-1985	<b>GMC C3500</b>	5.7L V8 5700cc 350 CID
	1977-1986	<b>CHEVROLET K10 SUBURBAN</b>	5.0L V8 305 CID		1980-1986	<b>GMC C3500</b>	5.7L V8 350 CID
	1977-1986	<b>CHEVROLET K10 SUBURBAN</b>	5.7L V8 350 CID		1981	<b>CHEVROLET CAPRICE</b>	5.7L V8 5700cc 350 CID
	1977-1986	<b>CHEVROLET K20</b>	5.7L V8 350 CID		1981	<b>GMC G3500</b>	5.0L V8 305 CID
	1977-1986	<b>CHEVROLET K20 SUBURBAN</b>	5.7L V8 350 CID		1981-1985	<b>CHEVROLET C10</b>	5.7L V8 5700cc 350 CID
	1977-1986	<b>CHEVROLET K30</b>	5.7L V8 350 CID		1981-1985	<b>GMC C1500</b>	5.7L V8 5700cc 350 CID
	1977-1987	<b>CHEVROLET CAMARO</b>	5.0L V8 305 CID		1981-1986	<b>CHEVROLET K10</b>	5.0L V8 305 CID
	1977-1987	<b>CHEVROLET EL CAMINO</b>	5.0L V8 305 CID		1981-1986	<b>GMC K1500</b>	5.0L V8 305 CID
	1977-1987	<b>GMC JIMMY</b>	5.0L V8 305 CID		1982	<b>CHEVROLET CAPRICE</b>	5.7L V8 5736cc 350 CID
	1977-1987	<b>PONTIAC FIREBIRD</b>	5.0L V8 305 CID		1982	<b>CHEVROLET G30</b>	5.0L V8 305 CID
	1977-1988	<b>CHEVROLET CAPRICE</b>	5.0L V8 305 CID		1982	<b>OLDSMOBILE CUTLASS CRUISER</b>	5.0L V8 305 CID
	1977-1988	<b>CHEVROLET G30</b>	5.7L V8 350 CID		1982-1983	<b>CHEVROLET MONTE CARLO</b>	5.7L V8 5700cc 350 CID
	1977-1988	<b>CHEVROLET MONTE CARLO</b>	5.0L V8 305 CID		1982-1985	<b>GMC K1500 SUBURBAN</b>	5.0L V8 305 CID
	1977-1988	<b>GMC JIMMY</b>	5.7L V8 350 CID		1982-1986	<b>GMC C2500 SUBURBAN</b>	5.0L V8 305 CID
	1977-1989	<b>CHEVROLET P20</b>	5.7L V8 350 CID		1983-1986	<b>PONTIAC BONNEVILLE</b>	5.0L V8 305 CID
	1977-1996	<b>CHEVROLET P30</b>	5.7L V8 350 CID		1983-1986	<b>PONTIAC PARISIENNE</b>	5.0L V8 305 CID
	1978	<b>BUICK LESABRE</b>	5.0L V8 305 CID		1983-1987	<b>PONTIAC GRAND PRIX</b>	5.0L V8 305 CID
	1978	<b>GMC C15</b>	6.6L V8 400 CID		1985	<b>CHEVROLET C20</b>	5.7L V8 5700cc 350 CID
	1978	<b>GMC C25 SUBURBAN</b>	6.6L V8 400 CID		1985	<b>CHEVROLET G30</b>	5.0L V8 305 CID
	1978	<b>PONTIAC SUNBIRD</b>	5.0L V8 305 CID		1985	<b>CHEVROLET IMPALA</b>	4.3L V6 262 CID
	1978-1979	<b>BUICK SKYLARK</b>	5.7L V8 350 CID		1985	<b>CHEVROLET K20</b>	4.3L V6 262 CID
	1978-1979	<b>CHEVROLET C30</b>	5.0L V8 305 CID		1985	<b>CHEVROLET K20</b>	5.0L V8 305 CID
	1978-1979	<b>CHEVROLET EL CAMINO</b>	3.3L V6 200 CID		1985	<b>GMC C2500</b>	5.7L V8 5700cc 350 CID
	1978-1979	<b>CHEVROLET G30</b>	5.0L V8 305 CID		1985	<b>GMC K2500</b>	4.3L V6 262 CID
	1978-1979	<b>CHEVROLET MALIBU</b>	3.3L V6 200 CID		1985-1986	<b>CHEVROLET ASTRO</b>	4.3L V6 262 CID
	1978-1979	<b>CHEVROLET MONTE CARLO</b>	3.3L V6 200 CID		1985-1986	<b>CHEVROLET C10</b>	4.3L V6 262 CID
	1978-1979	<b>GMC CABALLERO</b>	3.3L V6 200 CID		1985-1986	<b>CHEVROLET C20</b>	4.3L V6 262 CID
	1978-1979	<b>GMC CABALLERO</b>	5.7L V8 350 CID		1985-1986	<b>CHEVROLET G10</b>	4.3L V6 262 CID
	1978-1980	<b>PONTIAC GRAND AM</b>	5.0L V8 305 CID		1985-1986	<b>CHEVROLET G20</b>	4.3L V6 262 CID
	1978-1980	<b>PONTIAC GRAND PRIX</b>	5.0L V8 305 CID		1985-1986	<b>CHEVROLET G30</b>	4.3L V6 262 CID
	1978-1987	<b>GMC CABALLERO</b>	5.0L V8 305 CID		1985-1986	<b>CHEVROLET K10</b>	4.3L V6 262 CID
	1979	<b>GMC C2500</b>	6.6L V8 400 CID		1985-1986	<b>CHEVROLET K20 SUBURBAN</b>	5.0L V8 305 CID
	1979	<b>GMC G1500</b>	6.6L V8 400 CID		1985-1986	<b>GMC C1500</b>	4.3L V6 262 CID
	1979	<b>GMC K1500</b>	5.0L V8 305 CID		1985-1986	<b>GMC C2500</b>	4.3L V6 262 CID
	1979	<b>GMC K1500 SUBURBAN</b>	5.0L V8 305 CID		1985-1986	<b>GMC G1500</b>	4.3L V6 262 CID
	1979	<b>GMC K1500 SUBURBAN</b>	6.6L V8 400 CID		1985-1986	<b>GMC G2500</b>	4.3L V6 262 CID
	1979	<b>PONTIAC FIREBIRD</b>	5.7L V8 350 CID		1985-1986	<b>GMC G3500</b>	4.3L V6 262 CID
	1979-1980	<b>GMC C1500</b>	6.6L V8 400 CID		1985-1986	<b>GMC K1500</b>	4.3L V6 262 CID
	1979-1980	<b>GMC G2500</b>	6.6L V8 400 CID		1985-1986	<b>GMC SAFARI</b>	4.3L V6 262 CID
	1979-1980	<b>GMC G3500</b>	6.6L V8 400 CID		1985-1986	<b>PONTIAC PARISIENNE</b>	4.3L V6 262 CID
	1979-1980	<b>GMC K1500</b>	6.6L V8 400 CID		1985-1987	<b>CHEVROLET EL CAMINO</b>	4.3L V6 262 CID

**WATER PUMPS**

USMW	Years	Application	Engine	USMW	Years	Application	Engine
<b>US1121</b>	1985-1987	<b>GMC CABALLERO</b>	4.3L V6 262 CID	<b>US1121H</b>	1977-1978	<b>GMC K25 SUBURBAN</b>	6.6L V8 400 CID
	1985-1988	<b>CHEVROLET CAPRICE</b>	4.3L V6 262 CID		1977-1978	<b>GMC K35</b>	5.7L V8 350 CID
	1985-1988	<b>CHEVROLET MONTE CARLO</b>	4.3L V6 262 CID		1977-1978	<b>GMC K35</b>	6.6L V8 400 CID
	1986	<b>GMC C3500</b>	5.0L V8 305 CID		1977-1978	<b>GMC P25</b>	5.7L V8 350 CID
	1986	<b>PONTIAC BONNEVILLE</b>	4.3L V6 262 CID		1977-1978	<b>GMC P35</b>	5.7L V8 350 CID
	1986-1987	<b>CHEVROLET MICROBUS</b>	5.7L V8 5700cc 350 CID		1977-1979	<b>BUICK SKYLARK</b>	5.0L V8 305 CID
	1986-1987	<b>PONTIAC GRAND PRIX</b>	4.3L V6 262 CID		1977-1979	<b>CHEVROLET C30</b>	6.6L V8 400 CID
	1987	<b>CHEVROLET BLAZER</b>	5.0L V8 305 CID		1977-1979	<b>CHEVROLET EL CAMINO</b>	5.7L V8 350 CID
	1987	<b>CHEVROLET C10</b>	5.7L V8 5700cc 350 CID		1977-1979	<b>CHEVROLET K5 BLAZER</b>	6.6L V8 400 CID
	1987	<b>CHEVROLET C20</b>	5.7L V8 5700cc 350 CID		1977-1979	<b>CHEVROLET K10</b>	5.0L V8 305 CID
	1987	<b>CHEVROLET C35</b>	5.7L V8 5700cc 350 CID		1977-1979	<b>CHEVROLET K10 SUBURBAN</b>	6.6L V8 400 CID
	1987	<b>CHEVROLET CAMARO</b>	5.7L V8 350 CID		1977-1979	<b>CHEVROLET NOVA</b>	5.0L V8 305 CID
	1987	<b>CHEVROLET R10</b>	4.3L V6 262 CID		1977-1979	<b>CHEVROLET NOVA</b>	5.7L V8 350 CID
	1987	<b>CHEVROLET R10</b>	5.0L V8 305 CID		1977-1979	<b>CHEVROLET P20</b>	5.7L V8 350 CID
	1987	<b>CHEVROLET R10 SUBURBAN</b>	5.0L V8 305 CID		1977-1979	<b>CHEVROLET P30</b>	5.7L V8 350 CID
	1987	<b>CHEVROLET R20</b>	4.3L V6 262 CID		1977-1979	<b>GMC JIMMY</b>	6.6L V8 400 CID
	1987	<b>CHEVROLET R20</b>	5.0L V8 305 CID		1977-1979	<b>PONTIAC FIREBIRD</b>	5.7L V8 350 CID
	1987	<b>CHEVROLET R20</b>	5.0L V8 305 CID		1977-1979	<b>PONTIAC LEMANS</b>	5.7L V8 350 CID
	1987	<b>CHEVROLET V10</b>	4.3L V6 262 CID		1977-1979	<b>PONTIAC PHOENIX</b>	5.0L V8 305 CID
	1987	<b>CHEVROLET V10</b>	5.0L V8 305 CID		1977-1979	<b>PONTIAC PHOENIX</b>	5.7L V8 350 CID
	1987	<b>CHEVROLET V10</b>	5.7L V8 350 CID		1977-1980	<b>BUICK CENTURY</b>	5.0L V8 305 CID
	1987	<b>CHEVROLET V20</b>	5.7L V8 350 CID		1977-1980	<b>BUICK REGAL</b>	5.0L V8 305 CID
	1987	<b>CHEVROLET V20 SUBURBAN</b>	5.7L V8 350 CID		1977-1980	<b>CHEVROLET C10</b>	6.6L V8 400 CID
	1987	<b>GMC R1500</b>	4.3L V6 262 CID		1977-1980	<b>CHEVROLET C20</b>	6.6L V8 400 CID
	1987	<b>GMC R1500</b>	5.0L V8 305 CID		1977-1980	<b>CHEVROLET C20 SUBURBAN</b>	6.6L V8 400 CID
	1987	<b>GMC R1500</b>	5.7L V8 350 CID		1977-1980	<b>CHEVROLET CAPRICE</b>	5.7L V8 350 CID
	1987	<b>GMC R1500 SUBURBAN</b>	5.0L V8 305 CID		1977-1980	<b>CHEVROLET G20</b>	6.6L V8 400 CID
	1987	<b>GMC R2500</b>	4.3L V6 262 CID		1977-1980	<b>CHEVROLET G30</b>	6.6L V8 400 CID
	1987	<b>GMC R2500</b>	5.0L V8 305 CID		1977-1980	<b>CHEVROLET K10</b>	6.6L V8 400 CID
	1987	<b>GMC V1500</b>	4.3L V6 262 CID		1977-1980	<b>CHEVROLET K20</b>	6.6L V8 400 CID
	1987	<b>GMC V1500</b>	5.0L V8 305 CID		1977-1980	<b>CHEVROLET K20 SUBURBAN</b>	6.6L V8 400 CID
	1987	<b>GMC V1500</b>	5.7L V8 350 CID		1977-1980	<b>CHEVROLET K30</b>	6.6L V8 400 CID
	1987	<b>GMC V2500</b>	5.7L V8 350 CID		1977-1980	<b>PONTIAC LEMANS</b>	5.0L V8 305 CID
	1987	<b>PONTIAC FIREBIRD</b>	5.7L V8 350 CID		1977-1981	<b>CHEVROLET CAMARO</b>	5.7L V8 350 CID
	1987-1988	<b>CHEVROLET BLAZER</b>	5.7L V8 350 CID		1977-1981	<b>CHEVROLET MALIBU</b>	5.7L V8 350 CID
	1987-1988	<b>CHEVROLET R20</b>	5.7L V8 350 CID		1977-1983	<b>CHEVROLET MALIBU</b>	5.0L V8 305 CID
	1987-1988	<b>CHEVROLET R30</b>	5.7L V8 350 CID		1977-1985	<b>CHEVROLET IMPALA</b>	5.0L V8 305 CID
	1987-1988	<b>CHEVROLET V30</b>	5.7L V8 350 CID		1977-1985	<b>CHEVROLET IMPALA</b>	5.7L V8 350 CID
	1987-1988	<b>GMC C1500</b>	5.7L V8 5700cc 350 CID		1977-1986	<b>CHEVROLET C10</b>	5.0L V8 305 CID
	1987-1988	<b>GMC C2500</b>	5.7L V8 5700cc 350 CID		1977-1986	<b>CHEVROLET C10</b>	5.7L V8 350 CID
	1987-1988	<b>GMC C3500</b>	5.7L V8 5700cc 350 CID		1977-1986	<b>CHEVROLET C10 SUBURBAN</b>	5.0L V8 305 CID
	1987-1988	<b>GMC R1500 SUBURBAN</b>	5.7L V8 350 CID		1977-1986	<b>CHEVROLET C10 SUBURBAN</b>	5.7L V8 350 CID
	1987-1988	<b>GMC R2500 SUBURBAN</b>	5.7L V8 350 CID		1977-1986	<b>CHEVROLET C20</b>	5.0L V8 305 CID
	1987-1988	<b>GMC V1500 SUBURBAN</b>	5.7L V8 350 CID		1977-1986	<b>CHEVROLET C20</b>	5.7L V8 350 CID
	1987-1988	<b>GMC V2500 SUBURBAN</b>	5.7L V8 350 CID		1977-1986	<b>CHEVROLET C20 SUBURBAN</b>	5.0L V8 305 CID
	1987-1989	<b>GMC R2500</b>	5.7L V8 350 CID		1977-1986	<b>CHEVROLET C20 SUBURBAN</b>	5.7L V8 350 CID
	1987-1991	<b>GMC R3500</b>	5.7L V8 350 CID		1977-1986	<b>CHEVROLET C30</b>	5.7L V8 350 CID
	1987-1991	<b>GMC V3500</b>	5.7L V8 350 CID		1977-1986	<b>CHEVROLET G10</b>	5.0L V8 305 CID
	1989	<b>CHEVROLET R2500</b>	5.7L V8 350 CID		1977-1986	<b>CHEVROLET G10</b>	5.7L V8 350 CID
	1989-1991	<b>CHEVROLET R3500</b>	5.7L V8 350 CID		1977-1986	<b>CHEVROLET G20</b>	5.0L V8 305 CID
1989-1991	<b>CHEVROLET V3500</b>	5.7L V8 350 CID	1977-1986	<b>CHEVROLET G20</b>	5.7L V8 350 CID		
1990-1995	<b>CHEVROLET P30</b>	4.3L V6 262 CID	1977-1986	<b>CHEVROLET K5 BLAZER</b>	5.0L V8 305 CID		
1990-1995	<b>GMC P3500</b>	4.3L V6 262 CID	1977-1986	<b>CHEVROLET K5 BLAZER</b>	5.7L V8 350 CID		
1991-1995	<b>CHEVROLET P31 VAN</b>	5.7L V8 5737cc 350 CID	1977-1986	<b>CHEVROLET K10</b>	5.7L V8 350 CID		
<b>US1121H</b>	1977	<b>CHEVROLET MONTE CARLO</b>	5.7L V8 350 CID	1977-1986	<b>CHEVROLET K10 SUBURBAN</b>	5.0L V8 305 CID	
	1977	<b>GMC SPRINT</b>	5.0L V8 305 CID	1977-1986	<b>CHEVROLET K10 SUBURBAN</b>	5.7L V8 350 CID	
	1977	<b>GMC SPRINT</b>	5.7L V8 350 CID	1977-1986	<b>CHEVROLET K20</b>	5.7L V8 350 CID	
	1977	<b>PONTIAC GRAND PRIX</b>	5.7L V8 350 CID	1977-1986	<b>CHEVROLET K20 SUBURBAN</b>	5.7L V8 350 CID	
	1977	<b>PONTIAC VENTURA</b>	5.0L V8 305 CID	1977-1986	<b>CHEVROLET K30</b>	5.7L V8 350 CID	
	1977	<b>PONTIAC VENTURA</b>	5.7L V8 350 CID	1977-1987	<b>CHEVROLET CAMARO</b>	5.0L V8 305 CID	
	1977-1978	<b>CHEVROLET K20</b>	5.0L V8 305 CID	1977-1987	<b>CHEVROLET EL CAMINO</b>	5.0L V8 305 CID	
	1977-1978	<b>CHEVROLET K20 SUBURBAN</b>	5.0L V8 305 CID	1977-1987	<b>GMC JIMMY</b>	5.0L V8 305 CID	
	1977-1978	<b>GMC C15</b>	5.0L V8 305 CID	1977-1987	<b>PONTIAC FIREBIRD</b>	5.0L V8 305 CID	
	1977-1978	<b>GMC C15</b>	5.7L V8 350 CID	1977-1988	<b>CHEVROLET CAPRICE</b>	5.0L V8 305 CID	
	1977-1978	<b>GMC C15 SUBURBAN</b>	5.0L V8 305 CID	1977-1988	<b>CHEVROLET G30</b>	5.7L V8 350 CID	
	1977-1978	<b>GMC C15 SUBURBAN</b>	5.7L V8 350 CID	1977-1988	<b>CHEVROLET MONTE CARLO</b>	5.0L V8 305 CID	
	1977-1978	<b>GMC C25</b>	5.0L V8 305 CID	1977-1988	<b>GMC JIMMY</b>	5.7L V8 350 CID	
	1977-1978	<b>GMC C25</b>	5.7L V8 350 CID	1978	<b>BUICK LESABRE</b>	5.0L V8 305 CID	
	1977-1978	<b>GMC C25</b>	6.6L V8 400 CID	1978	<b>GMC C15</b>	6.6L V8 400 CID	
	1977-1978	<b>GMC C25 SUBURBAN</b>	5.0L V8 305 CID	1978	<b>GMC C25 SUBURBAN</b>	6.6L V8 400 CID	
	1977-1978	<b>GMC C25 SUBURBAN</b>	5.7L V8 350 CID	1978-1979	<b>CHEVROLET C30</b>	5.0L V8 305 CID	
	1977-1978	<b>GMC G15</b>	5.0L V8 305 CID	1978-1979	<b>CHEVROLET EL CAMINO</b>	3.3L V6 200 CID	
	1977-1978	<b>GMC G15</b>	5.7L V8 350 CID	1978-1979	<b>CHEVROLET G30</b>	5.0L V8 305 CID	
	1977-1978	<b>GMC G25</b>	5.0L V8 305 CID	1978-1979	<b>CHEVROLET MALIBU</b>	3.3L V6 200 CID	
	1977-1978	<b>GMC G25</b>	5.7L V8 350 CID	1978-1979	<b>CHEVROLET MONTE CARLO</b>	3.3L V6 200 CID	
	1977-1978	<b>GMC G25</b>	6.6L V8 400 CID	1978-1979	<b>GMC CABALLERO</b>	3.3L V6 200 CID	
	1977-1978	<b>GMC G35</b>	5.7L V8 350 CID	1978-1979	<b>GMC CABALLERO</b>	5.7L V8 350 CID	
	1977-1978	<b>GMC G35</b>	6.6L V8 400 CID	1978-1979	<b>PONTIAC SUNBIRD</b>	5.0L V8 305 CID	
	1977-1978	<b>GMC K15</b>	5.0L V8 305 CID	1978-1980	<b>PONTIAC GRAND AM</b>	5.0L V8 305 CID	
	1977-1978	<b>GMC K15</b>	5.7L V8 350 CID	1978-1980	<b>PONTIAC GRAND PRIX</b>	5.0L V8 305 CID	
	1977-1978	<b>GMC K15</b>	6.6L V8 400 CID	1978-1987	<b>GMC CABALLERO</b>	5.0L V8 305 CID	
	1977-1978	<b>GMC K15 SUBURBAN</b>	5.0L V8 305 CID	1979	<b>BUICK CENTURY</b>	5.7L V8 350 CID	
	1977-1978	<b>GMC K15 SUBURBAN</b>	5.7L V8 350 CID	1979	<b>BUICK SKYLARK</b>	5.7L V8 350 CID	
	1977-1978	<b>GMC K15 SUBURBAN</b>	6.6L V8 400 CID	1979	<b>GMC C2500</b>	6.6L V8 400 CID	
	1977-1978	<b>GMC K25</b>	5.0L V8 305 CID	1979	<b>GMC G1500</b>	6.6L V8 400 CID	
	1977-1978	<b>GMC K25</b>	5.7L V8 350 CID	1979	<b>GMC K1500</b>	5.0L V8 305 CID	
	1977-1978	<b>GMC K25</b>	6.6L V8 400 CID	1979	<b>GMC K1500 SUBURBAN</b>	5.0L V8 305 CID	
	1977-1978	<b>GMC K25 SUBURBAN</b>	5.0L V8 305 CID	1979	<b>GMC K1500 SUBURBAN</b>	6.6L V8 400 CID	
	1977-1978	<b>GMC K25 SUBURBAN</b>	5.7L V8 350 CID	1979	<b>GMC P2500</b>	5.7L V8 350 CID	

USMW	Years	Application	Engine	USMW	Years	Application	Engine	
<b>US1121H</b>	1979	GMC P3500	5.7L V8 350 CID	<b>US1121H</b>	1986-1987	PONTIAC GRAND PRIX	4.3L V6 262 CID	
	1979-1980	GMC C1500	6.6L V8 400 CID		1987	CHEVROLET BLAZER	5.0L V8 305 CID	
	1979-1980	GMC G2500	6.6L V8 400 CID		1987	CHEVROLET CAMARO	5.7L V8 350 CID	
	1979-1980	GMC G3500	6.6L V8 400 CID		1987	CHEVROLET R10	4.3L V6 262 CID	
	1979-1980	GMC K1500	6.6L V8 400 CID		1987	CHEVROLET R10	5.0L V8 305 CID	
	1979-1980	GMC K2500	6.6L V8 400 CID		1987	CHEVROLET R10	5.7L V8 350 CID	
	1979-1980	GMC K2500 SUBURBAN	6.6L V8 400 CID		1987	CHEVROLET R10 SUBURBAN	5.0L V8 305 CID	
	1979-1980	GMC K3500	6.6L V8 400 CID		1987	CHEVROLET R20	4.3L V6 262 CID	
	1979-1986	GMC C1500	5.0L V8 305 CID		1987	CHEVROLET R20	5.0L V8 305 CID	
	1979-1986	GMC C1500	5.7L V8 350 CID		1987	CHEVROLET V10	4.3L V6 262 CID	
	1979-1986	GMC C1500 SUBURBAN	5.0L V8 305 CID		1987	CHEVROLET V10	5.0L V8 305 CID	
	1979-1986	GMC C1500 SUBURBAN	5.7L V8 350 CID		1987	CHEVROLET V10	5.7L V8 350 CID	
	1979-1986	GMC C2500	5.0L V8 305 CID		1987	CHEVROLET V20	5.7L V8 350 CID	
	1979-1986	GMC C2500	5.7L V8 350 CID		1987	CHEVROLET V20 SUBURBAN	5.7L V8 350 CID	
	1979-1986	GMC C2500 SUBURBAN	5.7L V8 350 CID		1987	GMC R1500	4.3L V6 262 CID	
	1979-1986	GMC G1500	5.0L V8 305 CID		1987	GMC R1500	5.0L V8 305 CID	
	1979-1986	GMC G1500	5.7L V8 350 CID		1987	GMC R1500	5.7L V8 350 CID	
	1979-1986	GMC G2500	5.0L V8 305 CID		1987	GMC R1500 SUBURBAN	5.0L V8 305 CID	
	1979-1986	GMC G2500	5.7L V8 350 CID		1987	GMC R2500	4.3L V6 262 CID	
	1979-1986	GMC K1500	5.7L V8 350 CID		1987	GMC R2500	5.0L V8 305 CID	
	1979-1986	GMC K1500 SUBURBAN	5.7L V8 350 CID		1987	GMC V1500	4.3L V6 262 CID	
	1979-1986	GMC K2500	5.7L V8 350 CID		1987	GMC V1500	5.0L V8 305 CID	
	1979-1986	GMC K2500 SUBURBAN	5.7L V8 350 CID		1987	GMC V1500	5.7L V8 350 CID	
	1979-1986	GMC K3500	5.7L V8 350 CID		1987	GMC V2500	5.7L V8 350 CID	
	1979-1988	GMC G3500	5.7L V8 350 CID		1987	PONTIAC FIREBIRD	5.7L V8 350 CID	
	1980	CHEVROLET K20	5.0L V8 305 CID		1987-1988	CHEVROLET BLAZER	5.7L V8 350 CID	
	1980	GMC C2500 SUBURBAN	6.6L V8 400 CID		1987-1988	CHEVROLET R20	5.7L V8 350 CID	
	1980	OLDSMOBILE CUTLASS	5.0L V8 305 CID		1987-1988	CHEVROLET R30	5.7L V8 350 CID	
	1980	OLDSMOBILE CUTLASS CALAIS	5.0L V8 305 CID		1987-1988	CHEVROLET V30	5.7L V8 350 CID	
	1980	OLDSMOBILE CUTLASS CRUISER	5.0L V8 305 CID		1987-1988	GMC R1500 SUBURBAN	5.7L V8 350 CID	
	1980	OLDSMOBILE CUTLASS SALON	5.0L V8 305 CID		1987-1988	GMC R2500 SUBURBAN	5.7L V8 350 CID	
	1980	OLDSMOBILE CUTLASS SUPREME	5.0L V8 305 CID		1987-1988	GMC V1500 SUBURBAN	5.7L V8 350 CID	
	1980	PONTIAC GRAND LEMANS	3.8L V6 229 CID		1987-1988	GMC V2500 SUBURBAN	5.7L V8 350 CID	
	1980	PONTIAC GRAND LEMANS	5.0L V8 305 CID		1987-1989	GMC R2500	5.7L V8 350 CID	
	1980	PONTIAC LEMANS	3.8L V6 229 CID		1987-1991	GMC R3500	5.7L V8 350 CID	
	1980-1981	CHEVROLET CAMARO	3.8L V6 229 CID		1987-1991	GMC V3500	5.7L V8 350 CID	
	1980-1981	CHEVROLET CAMARO	4.4L V8 267 CID		1989-1991	CHEVROLET R3500	5.7L V8 350 CID	
	1980-1982	CHEVROLET CAPRICE	4.4L V8 267 CID		1989-1991	CHEVROLET V3500	5.7L V8 350 CID	
	1980-1982	CHEVROLET EL CAMINO	4.4L V8 267 CID		1990-1995	CHEVROLET P30	4.3L V6 262 CID	
	1980-1982	CHEVROLET IMPALA	4.4L V8 267 CID		1990-1995	GMC P3500	4.3L V6 262 CID	
	1980-1982	CHEVROLET MALIBU	4.4L V8 267 CID		<b>US1124</b>	1975	DODGE COLT	2.0L L4 1995cc 122 CID
	1980-1982	CHEVROLET MONTE CARLO	4.4L V8 267 CID		<b>US1127</b>	1975-1982	CHEVROLET LUV	1.8L L4 111 CID
	1980-1982	GMC CABALLERO	4.4L V8 267 CID		1981-1982	ISUZU PICKUP	1.8L L4 1817cc	
	1980-1983	CHEVROLET MALIBU	3.8L V6 229 CID		1981-1985	ISUZU I-MARK	1.8L L4 1817cc	
	1980-1984	CHEVROLET CAPRICE	3.8L V6 229 CID		1983-1987	ISUZU IMPULSE	1.9L L4 1949cc	
	1980-1984	CHEVROLET EL CAMINO	3.8L V6 229 CID		1983-1987	ISUZU PICKUP	1.9L L4 1949cc	
	1980-1984	CHEVROLET IMPALA	3.8L V6 229 CID		1984	ISUZU TROOPER	2.2L L4 2238cc	
	1980-1984	CHEVROLET MONTE CARLO	3.8L V6 229 CID		1984-1985	ISUZU TROOPER	1.9L L4 1949cc	
	1980-1984	GMC CABALLERO	3.8L V6 229 CID		<b>US1137</b>	1975-1977	CHEVROLET C20	4.8L L6 292 CID
	1980-1986	GMC C3500	5.7L V8 350 CID		1975-1977	CHEVROLET C20 SUBURBAN	4.8L L6 292 CID	
	1981	GMC G3500	5.0L V8 305 CID		1975-1977	CHEVROLET C30	4.8L L6 292 CID	
	1981-1986	CHEVROLET K10	5.0L V8 305 CID		1975-1977	CHEVROLET CS1073	4.8L L6 4800cc 292 CID	
	1981-1986	GMC K1500	5.0L V8 305 CID		1975-1977	CHEVROLET CS31003	4.8L L6 4800cc 292 CID	
	1982	CHEVROLET G30	5.0L V8 305 CID		1975-1977	CHEVROLET G20	4.8L L6 292 CID	
	1982	OLDSMOBILE CUTLASS CRUISER	5.0L V8 305 CID		1975-1977	CHEVROLET G30	4.8L L6 292 CID	
	1982-1985	GMC K1500 SUBURBAN	5.0L V8 305 CID		1975-1977	CHEVROLET K20	4.8L L6 292 CID	
	1982-1986	GMC C2500 SUBURBAN	5.0L V8 305 CID		1975-1977	CHEVROLET K20 SUBURBAN	4.8L L6 292 CID	
	1983-1986	PONTIAC BONNEVILLE	5.0L V8 305 CID		1975-1977	CHEVROLET P20	4.8L L6 292 CID	
	1983-1986	PONTIAC PARISIENNE	5.0L V8 305 CID		1975-1977	CHEVROLET P30	4.8L L6 292 CID	
	1983-1987	PONTIAC GRAND PRIX	5.0L V8 305 CID		1975-1977	GMC C25	4.8L L6 292 CID	
	1985	CHEVROLET G30	5.0L V8 305 CID		1975-1977	GMC C25 SUBURBAN	4.8L L6 292 CID	
	1985	CHEVROLET IMPALA	4.3L V6 262 CID		1975-1977	GMC G25	4.8L L6 292 CID	
	1985	CHEVROLET K20	4.3L V6 262 CID		1975-1977	GMC G35	4.8L L6 292 CID	
	1985	CHEVROLET K20	5.0L V8 305 CID		1975-1977	GMC K25	4.8L L6 292 CID	
	1985	GMC K2500	4.3L V6 262 CID		1975-1977	GMC K25 SUBURBAN	4.8L L6 292 CID	
	1985-1986	CHEVROLET ASTRO	4.3L V6 262 CID		1975-1977	GMC P25	4.8L L6 292 CID	
	1985-1986	CHEVROLET C10	4.3L V6 262 CID		1975-1977	GMC P35	4.8L L6 292 CID	
	1985-1986	CHEVROLET C20	4.3L V6 262 CID		1991	CHEVROLET P31 VAN	4.8L L6 4800cc 292 CID	
	1985-1986	CHEVROLET G10	4.3L V6 262 CID		<b>US1137H</b>	1975-1977	CHEVROLET C20	4.8L L6 292 CID
	1985-1986	CHEVROLET G20	4.3L V6 262 CID		1975-1977	CHEVROLET C20 SUBURBAN	4.8L L6 292 CID	
	1985-1986	CHEVROLET G30	4.3L V6 262 CID		1975-1977	CHEVROLET C30	4.8L L6 292 CID	
	1985-1986	CHEVROLET K10	4.3L V6 262 CID		1975-1977	CHEVROLET G20	4.8L L6 292 CID	
	1985-1986	CHEVROLET K20 SUBURBAN	5.0L V8 305 CID		1975-1977	CHEVROLET G30	4.8L L6 292 CID	
	1985-1986	GMC C1500	4.3L V6 262 CID		1975-1977	CHEVROLET K20	4.8L L6 292 CID	
	1985-1986	GMC C2500	4.3L V6 262 CID		1975-1977	CHEVROLET K20 SUBURBAN	4.8L L6 292 CID	
	1985-1986	GMC G1500	4.3L V6 262 CID		1975-1977	CHEVROLET P20	4.8L L6 292 CID	
	1985-1986	GMC G2500	4.3L V6 262 CID		1975-1977	CHEVROLET P30	4.8L L6 292 CID	
	1985-1986	GMC G3500	4.3L V6 262 CID		1975-1977	GMC C25	4.8L L6 292 CID	
	1985-1986	GMC K1500	4.3L V6 262 CID		1975-1977	GMC C25 SUBURBAN	4.8L L6 292 CID	
	1985-1986	GMC SAFARI	4.3L V6 262 CID		1975-1977	GMC G25	4.8L L6 292 CID	
	1985-1986	PONTIAC PARISIENNE	4.3L V6 262 CID		1975-1977	GMC G35	4.8L L6 292 CID	
	1985-1987	CHEVROLET EL CAMINO	4.3L V6 262 CID		1975-1977	GMC K25	4.8L L6 292 CID	
	1985-1987	GMC CABALLERO	4.3L V6 262 CID		1975-1977	GMC K25 SUBURBAN	4.8L L6 292 CID	
	1985-1988	CHEVROLET CAPRICE	4.3L V6 262 CID		1975-1977	GMC P25	4.8L L6 292 CID	
	1985-1988	CHEVROLET MONTE CARLO	4.3L V6 262 CID		1975-1977	GMC P35	4.8L L6 292 CID	
	1985-1995	GMC P3500	5.7L V8 350 CID		<b>US3400</b>	1977-1978	AMERICAN MOTORS GREMLIN	2.0L L4 121 CID
	1985-1996	CHEVROLET P30	5.7L V8 350 CID		1978-1979	AMERICAN MOTORS CONCORD	2.0L L4 121 CID	
	1986	GMC C3500	5.0L V8 305 CID		1979	AMERICAN MOTORS SPIRIT	2.0L L4 121 CID	
	1986	PONTIAC BONNEVILLE	4.3L V6 262 CID		<b>US3401</b>	1975-1976	AMERICAN MOTORS GREMLIN	5.0L V8 304 CID

WATER PUMPS



USMWW	Years	Application	Engine	USMWW	Years	Application	Engine	
<b>US3401</b>	1975-1976	<b>AMERICAN MOTORS</b> MATADOR	6.6L V8 401 CID	<b>US3409</b>	1985	<b>JEEP</b> WAGONEER	2.1L L4 126 CID	
	1975-1977	<b>AMERICAN MOTORS</b> HORNET	5.0L V8 304 CID		1985-1987	<b>JEEP</b> CHEROKEE	2.1L L4 126 CID	
	1975-1977	<b>AMERICAN MOTORS</b> MATADOR	5.0L V8 304 CID	1986-1987	<b>JEEP</b> COMANCHE	2.1L L4 126 CID		
	1975-1978	<b>AMERICAN MOTORS</b> MATADOR	5.9L V8 360 CID	<b>US3410</b>	1982-1983	<b>RENAULT</b> FUEGO	1.6L L4 1647cc 100 CID	
	1975-1978	<b>JEEP</b> CHEROKEE	6.6L V8 401 CID		1984-1985	<b>RENAULT</b> FUEGO	2.2L L4 2152cc 131 CID	
	1975-1978	<b>JEEP</b> J10	6.6L V8 401 CID		1984-1986	<b>RENAULT</b> R18I	2.2L L4 2152cc 131 CID	
	1975-1978	<b>JEEP</b> J20	6.6L V8 401 CID	1988-1989	<b>EAGLE</b> MEDALLION	2.2L L4 2163cc 132 CID		
	1975-1978	<b>JEEP</b> WAGONEER	6.6L V8 401 CID	<b>US3411</b>	1988-1991	<b>EAGLE</b> PREMIER	3.0L V6 2972cc 182 CID	
	1975-1983	<b>JEEP</b> CHEROKEE	5.9L V8 360 CID		1990-1991	<b>DODGE</b> MONACO	3.0L V6 2972cc 182 CID	
	1975-1983	<b>JEEP</b> WAGONEER	5.9L V8 360 CID	<b>US3412</b>	1987-1990	<b>JEEP</b> WAGONEER	4.0L L6 242 CID	
	1975-1988	<b>JEEP</b> J10	5.9L V8 360 CID		1987-1992	<b>JEEP</b> COMANCHE	4.0L L6 242 CID	
	1975-1988	<b>JEEP</b> J20	5.9L V8 360 CID		1987-2001	<b>JEEP</b> CHEROKEE	4.0L L6 242 CID	
	1976-1981	<b>JEEP</b> CJ7	5.0L V8 304 CID	1988-1989	<b>EAGLE</b> PREMIER	2.5L L4 150 CID		
	1978-1979	<b>AMERICAN MOTORS</b> AMX	5.0L V8 304 CID	<b>US3413</b>	1980-1983	<b>JEEP</b> CJ5	4.2L L6 258 CID	
	1978-1979	<b>AMERICAN MOTORS</b> CONCORD	5.0L V8 304 CID		1981-1982	<b>JEEP</b> CJ7	2.5L L4 151 CID	
	1978-1979	<b>AMERICAN MOTORS</b> PACER	5.0L V8 304 CID		1981-1982	<b>JEEP</b> SCRAMBLER	2.5L L4 151 CID	
	1980-1981	<b>JEEP</b> CJ5	5.0L V8 304 CID		1981-1983	<b>JEEP</b> CHEROKEE	4.2L L6 258 CID	
	1984-1991	<b>JEEP</b> GRAND WAGONEER	5.9L V8 360 CID		1981-1983	<b>JEEP</b> CJ5	2.5L L4 151 CID	
	<b>US3401H</b>	1975-1976	<b>AMERICAN MOTORS</b> GREMLIN		5.0L V8 304 CID	1981-1983	<b>JEEP</b> WAGONEER	4.2L L6 258 CID
		1975-1976	<b>AMERICAN MOTORS</b> MATADOR		6.6L V8 401 CID	1981-1985	<b>JEEP</b> SCRAMBLER	4.2L L6 258 CID
1975-1977		<b>AMERICAN MOTORS</b> HORNET	5.0L V8 304 CID		1981-1986	<b>JEEP</b> CJ7	4.2L L6 258 CID	
1975-1977		<b>AMERICAN MOTORS</b> MATADOR	5.0L V8 304 CID		1981-1987	<b>JEEP</b> J10	4.2L L6 258 CID	
1975-1978		<b>AMERICAN MOTORS</b> MATADOR	5.9L V8 360 CID		1983-1985	<b>JEEP</b> SCRAMBLER	2.5L L4 150 CID	
1975-1978		<b>JEEP</b> CHEROKEE	6.6L V8 401 CID	1983-1986	<b>JEEP</b> CJ7	2.5L L4 150 CID		
1975-1978		<b>JEEP</b> J10	6.6L V8 401 CID	1984	<b>AMERICAN MOTORS</b> EAGLE	2.5L L4 150 CID		
1975-1978		<b>JEEP</b> J20	6.6L V8 401 CID	1984-1986	<b>JEEP</b> GRAND WAGONEER	4.2L L6 258 CID		
1975-1978		<b>JEEP</b> WAGONEER	6.6L V8 401 CID	1984-1987	<b>JEEP</b> WAGONEER	2.5L L4 150 CID		
1975-1983		<b>JEEP</b> CHEROKEE	5.9L V8 360 CID	1984-1988	<b>AMERICAN MOTORS</b> EAGLE	4.2L L6 258 CID		
1975-1983		<b>JEEP</b> WAGONEER	5.9L V8 360 CID	1984-1990	<b>JEEP</b> CHEROKEE	2.5L L4 150 CID		
1975-1988		<b>JEEP</b> J10	5.9L V8 360 CID	1986-1990	<b>JEEP</b> COMANCHE	2.5L L4 150 CID		
1975-1988		<b>JEEP</b> J20	5.9L V8 360 CID	1987-1990	<b>JEEP</b> WRANGLER	2.5L L4 150 CID		
1976-1981		<b>JEEP</b> CJ7	5.0L V8 304 CID	1987-1990	<b>JEEP</b> WRANGLER	4.2L L6 258 CID		
1978-1979		<b>AMERICAN MOTORS</b> AMX	5.0L V8 304 CID	<b>US3414</b>	1980	<b>AMERICAN MOTORS</b> AMX	4.2L L6 258 CID	
1978-1979		<b>AMERICAN MOTORS</b> CONCORD	5.0L V8 304 CID		1980	<b>AMERICAN MOTORS</b> PACER	4.2L L6 258 CID	
1978-1979		<b>AMERICAN MOTORS</b> PACER	5.0L V8 304 CID		1980-1983	<b>AMERICAN MOTORS</b> CONCORD	4.2L L6 258 CID	
1980-1981		<b>JEEP</b> CJ5	5.0L V8 304 CID		1980-1983	<b>AMERICAN MOTORS</b> SPIRIT	4.2L L6 258 CID	
1984-1991		<b>JEEP</b> GRAND WAGONEER	5.9L V8 360 CID		1980-1983	<b>JEEP</b> CHEROKEE	4.2L L6 258 CID	
1975-1978		<b>JEEP</b> CJ5D	4.2L L6 4200cc 258 CID		1980-1983	<b>JEEP</b> CJ5	4.2L L6 258 CID	
1975-1986	<b>JEEP</b> CJ5D	4.6L L6 4600cc 282 CID	1980-1983		<b>JEEP</b> WAGONEER	4.2L L6 258 CID		
1980	<b>AMERICAN MOTORS</b> AMX	4.2L L6 258 CID	1980-1986		<b>JEEP</b> CJ7	4.2L L6 258 CID		
1980	<b>AMERICAN MOTORS</b> PACER	4.2L L6 258 CID	1980-1987		<b>JEEP</b> J10	4.2L L6 258 CID		
1980-1983	<b>AMERICAN MOTORS</b> AMERICAN	4.2L L6 4200cc 258 CID	1980-1988		<b>AMERICAN MOTORS</b> EAGLE	4.2L L6 258 CID		
1980-1983	<b>AMERICAN MOTORS</b> AMERICAN	4.6L L6 4600cc 282 CID	1981-1982	<b>JEEP</b> CJ7	2.5L L4 151 CID			
1980-1983	<b>AMERICAN MOTORS</b> CONCORD	4.2L L6 258 CID	1981-1982	<b>JEEP</b> SCRAMBLER	2.5L L4 151 CID			
1980-1983	<b>AMERICAN MOTORS</b> GREMLIN	4.2L L6 4200cc 258 CID	1981-1983	<b>JEEP</b> CJ5	2.5L L4 151 CID			
1980-1983	<b>AMERICAN MOTORS</b> GREMLIN	4.6L L6 4600cc 282 CID	1981-1985	<b>JEEP</b> SCRAMBLER	4.2L L6 258 CID			
1980-1983	<b>AMERICAN MOTORS</b> LERMA	4.6L L6 4600cc 282 CID	1983-1984	<b>AMERICAN MOTORS</b> EAGLE	2.5L L4 150 CID			
1980-1983	<b>AMERICAN MOTORS</b> SPIRIT	4.2L L6 258 CID	1983-1985	<b>JEEP</b> SCRAMBLER	2.5L L4 150 CID			
1980-1983	<b>JEEP</b> CHEROKEE	4.2L L6 258 CID	1983-1986	<b>JEEP</b> CJ7	2.5L L4 150 CID			
1980-1983	<b>JEEP</b> CJ5	4.2L L6 258 CID	1984-1986	<b>JEEP</b> GRAND WAGONEER	4.2L L6 258 CID			
1980-1983	<b>JEEP</b> WAGONEER	4.2L L6 258 CID	1984-1987	<b>JEEP</b> WAGONEER	2.5L L4 150 CID			
1980-1984	<b>JEEP</b> J364R	4.6L L6 4600cc 282 CID	1984-1990	<b>JEEP</b> CHEROKEE	2.5L L4 150 CID			
1980-1986	<b>JEEP</b> CJ7	4.2L L6 258 CID	1986-1990	<b>JEEP</b> COMANCHE	2.5L L4 150 CID			
1980-1986	<b>JEEP</b> CJ7	4.6L L6 4600cc 282 CID	1987-1990	<b>JEEP</b> WRANGLER	2.5L L4 150 CID			
1980-1986	<b>JEEP</b> J100	4.6L L6 4600cc 282 CID	1987-1990	<b>JEEP</b> WRANGLER	4.2L L6 258 CID			
1980-1986	<b>JEEP</b> J164	4.6L L6 4600cc 282 CID	<b>US3705</b>	1980	<b>INTERNATIONAL</b> CARGOSTAR	6.6L V8 404 CID		
1980-1986	<b>JEEP</b> J164V	4.6L L6 4600cc 282 CID		1980	<b>INTERNATIONAL</b> CARGOSTAR	7.3L V8 446 CID		
1980-1986	<b>JEEP</b> WAGONEER	4.6L L6 4600cc 282 CID		1980	<b>INTERNATIONAL</b> S1723	6.6L V8 404 CID		
1980-1987	<b>JEEP</b> J10	4.2L L6 258 CID		1980	<b>INTERNATIONAL</b> S1724	6.6L V8 404 CID		
1980-1988	<b>AMERICAN MOTORS</b> EAGLE	4.2L L6 258 CID		1980	<b>INTERNATIONAL</b> S1823	6.6L V8 404 CID		
1981-1982	<b>JEEP</b> CJ7	2.5L L4 151 CID		1980	<b>INTERNATIONAL</b> S1823	7.3L V8 446 CID		
1981-1982	<b>JEEP</b> SCRAMBLER	2.5L L4 151 CID		1980	<b>INTERNATIONAL</b> S1824	6.6L V8 404 CID		
1981-1983	<b>AMERICAN MOTORS</b> RALLY	4.2L L6 4200cc 258 CID		1980	<b>INTERNATIONAL</b> S1824	7.3L V8 446 CID		
1981-1983	<b>AMERICAN MOTORS</b> RALLY	4.6L L6 4600cc 282 CID		1980	<b>INTERNATIONAL</b> S1924	7.3L V8 446 CID		
1981-1983	<b>JEEP</b> CJ5	2.5L L4 151 CID		1980	<b>INTERNATIONAL</b> S1925	6.6L V8 404 CID		
1981-1985	<b>JEEP</b> SCRAMBLER	4.2L L6 258 CID		1980	<b>INTERNATIONAL</b> S1925	7.3L V8 446 CID		
1983-1984	<b>AMERICAN MOTORS</b> EAGLE	2.5L L4 150 CID		1984-1986	<b>INTERNATIONAL</b> CARGOSTAR	6.8L V8 420 CID		
1983-1985	<b>JEEP</b> SCRAMBLER	2.5L L4 150 CID		1984-1988	<b>INTERNATIONAL</b> S1654	6.8L V8 420 CID		
1983-1986	<b>JEEP</b> CJ7	2.5L L4 150 CID		1984-1988	<b>INTERNATIONAL</b> S1753	6.8L V8 420 CID		
1984-1985	<b>JEEP</b> CJ10	4.6L L6 4600cc 282 CID		1986	<b>INTERNATIONAL</b> F1954	6.8L V8 420 CID		
1984-1986	<b>JEEP</b> CJ5D	4.2L L6 4200cc 258 CID		1987	<b>INTERNATIONAL</b> M1400 METRO II	6.8L V8 420 CID		
1984-1986	<b>JEEP</b> GRAND WAGONEER	4.2L L6 258 CID		1987	<b>INTERNATIONAL</b> M1600 METRO II	6.8L V8 420 CID		
1984-1987	<b>JEEP</b> WAGONEER	2.5L L4 150 CID		1988	<b>INTERNATIONAL</b> S1754	7.3L V8 444 CID		
1984-1990	<b>JEEP</b> CHEROKEE	2.5L L4 150 CID		1988	<b>INTERNATIONAL</b> S1853	6.8L V8 420 CID		
1986-1990	<b>JEEP</b> COMANCHE	2.5L L4 150 CID		1988-1989	<b>INTERNATIONAL</b> S1654	7.3L V8 444 CID		
1987-1990	<b>JEEP</b> WRANGLER	2.5L L4 150 CID	1988-1989	<b>INTERNATIONAL</b> S1654LP	7.3L V8 444 CID			
1987-1990	<b>JEEP</b> WRANGLER	4.2L L6 258 CID	1988-1989	<b>INTERNATIONAL</b> S1753	7.3L V8 444 CID			
<b>US3404</b>	1981-1983	<b>AMERICAN MOTORS</b> CONCORD	4.2L L6 258 CID	1988-1990	<b>INTERNATIONAL</b> M1400 METRO II	7.3L V8 444 CID		
	1981-1983	<b>AMERICAN MOTORS</b> EAGLE	4.2L L6 258 CID	1988-1990	<b>INTERNATIONAL</b> M1600 METRO II	7.3L V8 444 CID		
	1981-1983	<b>AMERICAN MOTORS</b> SPIRIT	4.2L L6 258 CID	1990	<b>INTERNATIONAL</b> 1652UPS	6.8L V8 420 CID		
	1983	<b>AMERICAN MOTORS</b> EAGLE	2.5L L4 150 CID	1990	<b>INTERNATIONAL</b> 3800	7.3L V8 444 CID		
<b>US3406</b>	1975-1979	<b>RENAULT</b> R12	1.6L L4 1647cc 100 CID	1990-1991	<b>INTERNATIONAL</b> 1652UPS	7.3L V8 444 CID		
	1975-1980	<b>RENAULT</b> R12	1.6L L4 1600cc 98 CID	1990-1993	<b>INTERNATIONAL</b> 3700	7.3L V8 444 CID		
	1980	<b>RENAULT</b> R18	1.6L L4 1600cc 98 CID	1990-1993	<b>INTERNATIONAL</b> 4600LP	7.3L V8 444 CID		
	1981-1983	<b>RENAULT</b> R18I	1.6L L4 1647cc 100 CID	1991	<b>INTERNATIONAL</b> 3700	6.8L V8 420 CID		
	1982-1984	<b>RENAULT</b> FUEGO	1.6L L4 1565cc	1991	<b>INTERNATIONAL</b> 3800	6.8L V8 420 CID		
	1984	<b>RENAULT</b> R18	1.6L L4 1600cc 98 CID	1991	<b>INTERNATIONAL</b> 4900	7.3L V8 444 CID		
	<b>US3408</b>	1985-1986	<b>RENAULT</b> ENCORE	1.7L L4 105 CID	1992-1993	<b>INTERNATIONAL</b> 3600	7.3L V8 444 CID	
		1985-1987	<b>RENAULT</b> ALLIANCE	1.7L L4 105 CID	<b>US4002</b>	1975-1977	<b>FORD</b> GRANADA	3.3L L6 200 CID

USMW	Years	Application	Engine	USMW	Years	Application	Engine	
<b>US4002</b>	1975-1977	FORD MAVERICK	3.3L L6 200 CID	<b>US4018</b>	1983-1987	FORD E-350 ECONOLINE	6.9L V8 420 CID	
	1975-1977	MERCURY COMET	3.3L L6 200 CID		1983-1987	FORD E-350 ECONOLINE CLUB WAGON	6.9L V8 420 CID	
	1975-1977	MERCURY MONARCH	3.3L L6 200 CID		1983-1987	FORD F-250	6.9L V8 420 CID	
	1978-1983	FORD FAIRMONT	3.3L L6 200 CID		1983-1987	FORD F-350	6.9L V8 420 CID	
	1978-1983	MERCURY ZEPHYR	3.3L L6 200 CID		1988-1991	FORD E-250 ECONOLINE CLUB WAGON	7.3L V8 445 CID	
	1979-1982	FORD MUSTANG	3.3L L6 200 CID		1988-1994	FORD E-350 ECONOLINE	7.3L V8 445 CID	
	1979-1982	MERCURY CAPRI	3.3L L6 200 CID		1988-1994	FORD E-350 ECONOLINE CLUB WAGON	7.3L V8 445 CID	
	1980-1982	FORD THUNDERBIRD	3.3L L6 200 CID		1988-1994	FORD F-250	7.3L V8 445 CID	
	1980-1982	MERCURY COUGAR	3.3L L6 200 CID		1988-1994	FORD F-350	7.3L V8 445 CID	
	1981-1982	FORD GRANADA	3.3L L6 200 CID		1988-1994	FORD F SUPER DUTY	7.3L V8 445 CID	
	1983	FORD LTD	3.3L L6 200 CID		1993-1997	FORD F59	7.3L V8 445 CID	
	1983	MERCURY MARQUIS	3.3L L6 200 CID					
	<b>US4003</b>	1978-1980	FORD FIESTA		1.6L L4 1598cc 98 CID	<b>US4020</b>	1983	FORD E-100 ECONOLINE
<b>US4005</b>	1975-1977	MERCURY CAPRI	2.3L L4 140 CID	1983	FORD E-100 ECONOLINE CLUB WAGON		4.9L L6 4917cc 300 CID	
	1975-1978	FORD MUSTANG II	2.3L L4 140 CID	1983	FORD F-100		4.9L L6 4917cc 300 CID	
	1975-1980	FORD PINTO	2.3L L4 140 CID	1983-1986	FORD BRONCO		4.9L L6 4917cc 300 CID	
	1975-1980	MERCURY BOBCAT	2.3L L4 140 CID	1983-1986	FORD E-150 ECONOLINE		4.9L L6 4917cc 300 CID	
	1977-1982	FORD COURIER	2.3L L4 140 CID	1983-1986	FORD E-150 ECONOLINE CLUB WAGON		4.9L L6 4917cc 300 CID	
	1978-1982	FORD FAIRMONT	2.3L L4 140 CID	1983-1986	FORD E-250 ECONOLINE		4.9L L6 4917cc 300 CID	
	1978-1982	MERCURY ZEPHYR	2.3L L4 140 CID	1983-1986	FORD E-250 ECONOLINE CLUB WAGON		4.9L L6 4917cc 300 CID	
	1979-1982	FORD MUSTANG	2.3L L4 140 CID	1983-1986	FORD E-350 ECONOLINE		4.9L L6 4917cc 300 CID	
	1979-1982	MERCURY CAPRI	2.3L L4 140 CID	1983-1986	FORD E-350 ECONOLINE CLUB WAGON		4.9L L6 4917cc 300 CID	
	1981-1982	FORD GRANADA	2.3L L4 140 CID	1983-1986	FORD F-150		4.9L L6 4917cc 300 CID	
	1979-1981	MERCURY GRAND MARQUIS	5.8L V8 351 CID	1983-1986	FORD F-250		4.9L L6 4917cc 300 CID	
	1979-1988	MERCURY GRAND MARQUIS	5.0L V8 302 CID	1983-1986	FORD F-350		4.9L L6 4917cc 300 CID	
	1980	LINCOLN CONTINENTAL	5.8L V8 351 CID	<b>US4022</b>	1984-1985	FORD TOPAZ	2.3L L4 2300cc 140 CID	
1980	LINCOLN MARK VI	5.8L V8 351 CID	1984-1989		MERCURY TOPAZ	2.3L L4 2300cc 140 CID		
1980-1981	FORD THUNDERBIRD	5.0L V8 302 CID	1984-1991		FORD TEMPO	2.3L L4 140 CID		
1980-1981	MERCURY COUGAR	5.0L V8 302 CID	1984-1991		MERCURY TOPAZ	2.3L L4 140 CID		
1980-1981	MERCURY MARQUIS	5.8L V8 351 CID	1986-1991		FORD TOPAZ	2.3L L4 2294cc 140 CID		
1980-1982	FORD THUNDERBIRD	4.2L V8 255 CID	1990		FORD GHIA	2.3L L4 2300cc 140 CID		
1980-1982	MERCURY COUGAR	4.2L V8 255 CID	<b>US4023</b>		1983-1985	FORD RANGER	2.8L V6 171 CID	
1980-1982	MERCURY MARQUIS	5.0L V8 302 CID			1984-1985	FORD BRONCO II	2.8L V6 171 CID	
1980-1983	LINCOLN MARK VI	5.0L V8 302 CID	1986		FORD AEROSTAR	2.8L V6 171 CID		
1980-1986	FORD LTD	5.0L V8 302 CID	<b>US4024</b>		1974	FORD MUSTANG	5.0L V8 5000cc 302 CID	
1980-1986	FORD LTD	5.8L V8 351 CID			1979	FORD MUSTANG	5.0L V8 302 CID	
1981-1982	FORD LTD	4.2L V8 255 CID			1979	MERCURY CAPRI	5.0L V8 302 CID	
1981-1982	MERCURY GRAND MARQUIS	4.2L V8 255 CID			1979-1981	FORD MUSTANG	5.0L V8 5000cc 302 CID	
1981-1982	MERCURY MARQUIS	4.2L V8 255 CID		1980-1982	FORD MUSTANG	4.2L V8 255 CID		
1982-1988	LINCOLN TOWN CAR	5.0L V8 302 CID		1980-1982	MERCURY CAPRI	4.2L V8 255 CID		
1983-1984	LINCOLN CONTINENTAL	5.0L V8 302 CID		1982-1985	FORD MUSTANG	5.0L V8 302 CID		
1983-1985	FORD THUNDERBIRD	5.0L V8 302 CID		1982-1985	MERCURY CAPRI	5.0L V8 302 CID		
1983-1985	MERCURY COUGAR	5.0L V8 302 CID		1983-1984	FORD MUSTANG	5.0L V8 5000cc 302 CID		
1984	LINCOLN MARK VII	5.0L V8 302 CID		1985	FORD LTD	5.0L V8 302 CID		
1986	MERCURY GRAND MARQUIS	5.8L V8 351 CID		1985	LINCOLN CONTINENTAL	5.0L V8 302 CID		
1987-1988	FORD COUNTRY SQUIRE	5.0L V8 302 CID		1985	LINCOLN MARK VII	5.0L V8 302 CID		
1987-1988	FORD LTD CROWN VICTORIA	5.0L V8 302 CID		<b>US4024H</b>	1979	FORD MUSTANG	5.0L V8 302 CID	
1987-1988	MERCURY COLONY PARK	5.0L V8 302 CID	1979		MERCURY CAPRI	5.0L V8 302 CID		
1987-1991	FORD LTD CROWN VICTORIA	5.8L V8 351 CID	1980-1982		FORD MUSTANG	4.2L V8 255 CID		
<b>US4014H</b>	1979-1981	MERCURY GRAND MARQUIS	5.8L V8 351 CID		1980-1982	MERCURY CAPRI	4.2L V8 255 CID	
	1979-1988	MERCURY GRAND MARQUIS	5.0L V8 302 CID		1982-1985	FORD MUSTANG	5.0L V8 302 CID	
	1980	LINCOLN CONTINENTAL	5.8L V8 351 CID		1982-1985	MERCURY CAPRI	5.0L V8 302 CID	
	1980	LINCOLN MARK VI	5.8L V8 351 CID		1985	FORD LTD	5.0L V8 302 CID	
	1980-1981	FORD THUNDERBIRD	5.0L V8 302 CID		1985	LINCOLN CONTINENTAL	5.0L V8 302 CID	
	1980-1981	MERCURY COUGAR	5.0L V8 302 CID		1985	LINCOLN MARK VII	5.0L V8 302 CID	
	1980-1981	MERCURY MARQUIS	5.8L V8 351 CID		<b>US4030N</b>	1975-1978	FORD F-350	4.9L L6 4917cc 300 CID
	1980-1982	FORD THUNDERBIRD	4.2L V8 255 CID			1975-1982	FORD E-100 ECONOLINE	4.9L L6 4917cc 300 CID
	1980-1982	MERCURY COUGAR	4.2L V8 255 CID			1975-1982	FORD E-100 ECONOLINE CLUB WAGON	4.9L L6 4917cc 300 CID
	1980-1982	MERCURY MARQUIS	5.0L V8 302 CID			1975-1982	FORD E-150 ECONOLINE	4.9L L6 4917cc 300 CID
	1980-1983	LINCOLN MARK VI	5.0L V8 302 CID	1975-1982		FORD E-150 ECONOLINE CLUB WAGON	4.9L L6 4917cc 300 CID	
	1980-1986	FORD LTD	5.0L V8 302 CID	1975-1982		FORD E-250 ECONOLINE	4.9L L6 4917cc 300 CID	
	1980-1986	FORD LTD	5.8L V8 351 CID	1975-1982		FORD E-350 ECONOLINE	4.9L L6 4917cc 300 CID	
1981-1982	FORD LTD	4.2L V8 255 CID	1975-1982	FORD F-100		4.9L L6 4917cc 300 CID		
1981-1982	MERCURY GRAND MARQUIS	4.2L V8 255 CID	1975-1982	FORD F-150		4.9L L6 4917cc 300 CID		
1981-1982	MERCURY MARQUIS	4.2L V8 255 CID	1975-1982	FORD F-250		4.9L L6 4917cc 300 CID		
1982-1988	LINCOLN TOWN CAR	5.0L V8 302 CID	1977-1980	FORD E-250 ECONOLINE CLUB WAGON		4.9L L6 4917cc 300 CID		
1983-1984	LINCOLN CONTINENTAL	5.0L V8 302 CID	1977-1982	FORD E-350 ECONOLINE CLUB WAGON		4.9L L6 4917cc 300 CID		
1983-1985	FORD THUNDERBIRD	5.0L V8 302 CID	1979	FORD F-350		5.8L V8 351 CID		
1983-1985	MERCURY COUGAR	5.0L V8 302 CID	1980-1982	FORD BRONCO	4.9L L6 4917cc 300 CID			
1984	LINCOLN MARK VII	5.0L V8 302 CID	1980-1982	FORD F-350	4.9L L6 4917cc 300 CID			
1986	MERCURY GRAND MARQUIS	5.8L V8 351 CID	<b>US4033</b>	1975-1977	FORD E-150 ECONOLINE	4.9L L6 4917cc 300 CID		
1987-1988	FORD COUNTRY SQUIRE	5.0L V8 302 CID		1975-1977	FORD E-150 ECONOLINE CLUB WAGON	4.9L L6 4917cc 300 CID		
1987-1988	FORD LTD CROWN VICTORIA	5.0L V8 302 CID		1975-1977	FORD E-250 ECONOLINE	4.9L L6 4917cc 300 CID		
1987-1988	MERCURY COLONY PARK	5.0L V8 302 CID		1975-1977	FORD E-350 ECONOLINE	4.9L L6 4917cc 300 CID		
1987-1991	FORD LTD CROWN VICTORIA	5.8L V8 351 CID		1975-1977	FORD F-150	4.9L L6 4917cc 300 CID		
<b>US4016</b>	1982	FORD GRANADA		3.8L V6 232 CID	1975-1977	FORD F-250	4.9L L6 4917cc 300 CID	
	1982	LINCOLN CONTINENTAL		3.8L V6 232 CID	1975-1977	FORD F-350	4.9L L6 4917cc 300 CID	
	1982-1983	FORD F-100		3.8L V6 232 CID	1977	FORD E-250 ECONOLINE CLUB WAGON	4.9L L6 4917cc 300 CID	
	1982-1987	FORD THUNDERBIRD		3.8L V6 232 CID	1977	FORD E-350 ECONOLINE CLUB WAGON	4.9L L6 4917cc 300 CID	
	1982-1987	MERCURY COUGAR		3.8L V6 232 CID				
	1983-1986	FORD LTD		3.8L V6 232 CID				
	1983-1986	FORD MUSTANG		3.8L V6 232 CID				
	1983-1986	MERCURY CAPRI		3.8L V6 232 CID				
	1983-1986	MERCURY MARQUIS	3.8L V6 232 CID					
	1984	FORD THUNDERBIRD	3.8L V6 3800cc 232 CID					
	1984-1990	FORD F150	3.8L V6 3800cc 232 CID					
	1985-1987	FORD COUGAR	3.8L V6 3800cc 232 CID					
	1987	FORD COUGAR	3.8L V6 3802cc 232 CID					
<b>US4018</b>	1983-1987	FORD E-250 ECONOLINE CLUB WAGON	6.9L V8 420 CID					

WATER PUMPS

USMW	Years	Application	Engine	USMW	Years	Application	Engine		
<b>US4034</b>	1986-1994	<b>FORD TAURUS</b>	3.0L V6 2986cc 182 CID	<b>US4044</b>	1994-1997	<b>FORD F350</b>	5.0L V8 5000cc 302 CID		
	1986-1994	<b>MERCURY SABLE</b>	3.0L V6 2986cc 182 CID		1996	<b>FORD ECONOLINE SUPER DUTY</b>	5.8L V8 351 CID		
<b>US4035</b>	1984-1985	<b>FORD MUSTANG</b>	5.0L V8 302 CID	1997	<b>FORD F250</b>	5.0L V8 5000cc 302 CID			
	1985	<b>MERCURY CAPRI</b>	5.0L V8 302 CID	1999-2002	<b>FORD ECONOLINE WAGON</b>	5.0L V8 5000cc 305 CID			
<b>US4037</b>	1980-1985	<b>FORD L800</b>	6.1L V8 370 CID	<b>US4044H</b>	1987-1989	<b>FORD F-250</b>	5.0L V8 302 CID		
	1980-1985	<b>FORD L800</b>	7.0L V8 429 CID		1987-1991	<b>FORD E-250 ECONOLINE</b>	5.0L V8 302 CID		
	1980-1985	<b>FORD LN600</b>	6.1L V8 370 CID		1987-1996	<b>FORD BRONCO</b>	5.0L V8 302 CID		
	1980-1985	<b>FORD LN700</b>	6.1L V8 370 CID		1987-1996	<b>FORD E-150 ECONOLINE</b>	5.0L V8 302 CID		
	1980-1985	<b>FORD LN700</b>	7.0L V8 429 CID		1987-1996	<b>FORD E-150 ECONOLINE CLUB WAGON</b>	5.0L V8 302 CID		
	1980-1985	<b>FORD LN800</b>	6.1L V8 370 CID		1987-1996	<b>FORD F-150</b>	5.0L V8 302 CID		
	1980-1985	<b>FORD LN800</b>	7.0L V8 429 CID		1988-1991	<b>FORD E-250 ECONOLINE CLUB WAGON</b>	5.8L V8 351 CID		
	1980-1986	<b>FORD C600</b>	6.1L V8 370 CID		1988-1996	<b>FORD BRONCO</b>	5.8L V8 351 CID		
	1980-1986	<b>FORD C700</b>	6.1L V8 370 CID		1988-1996	<b>FORD E-150 ECONOLINE</b>	5.8L V8 351 CID		
	1980-1986	<b>FORD C700</b>	7.0L V8 429 CID		1988-1996	<b>FORD E-150 ECONOLINE CLUB WAGON</b>	5.8L V8 351 CID		
	1980-1986	<b>FORD C800</b>	6.1L V8 370 CID		1988-1996	<b>FORD E-250 ECONOLINE</b>	5.8L V8 351 CID		
	1980-1986	<b>FORD C800</b>	7.0L V8 429 CID		1988-1996	<b>FORD E-350 ECONOLINE</b>	5.8L V8 351 CID		
	1980-1986	<b>FORD FT800</b>	6.1L V8 370 CID		1988-1996	<b>FORD E-350 ECONOLINE CLUB WAGON</b>	5.8L V8 351 CID		
	1980-1986	<b>FORD FT800</b>	7.0L V8 429 CID		1988-1996	<b>FORD F-150</b>	5.8L V8 351 CID		
	1980-1989	<b>FORD B600</b>	6.1L V8 370 CID		1988-1996	<b>FORD F-250</b>	5.8L V8 351 CID		
	1980-1989	<b>FORD B700</b>	6.1L V8 370 CID		1988-1997	<b>FORD F-350</b>	5.8L V8 351 CID		
	1980-1989	<b>FORD B700</b>	7.0L V8 429 CID		1991-1996	<b>FORD F-250</b>	5.0L V8 302 CID		
	1980-1990	<b>FORD F800</b>	7.0L V8 429 CID		1996	<b>FORD ECONOLINE SUPER DUTY</b>	5.8L V8 351 CID		
	1980-1991	<b>FORD F600</b>	6.1L V8 370 CID		<b>US4048</b>	1987-1989	<b>FORD F-350</b>	4.9L L6 4917cc 300 CID	
	1980-1991	<b>FORD F700</b>	6.1L V8 370 CID			1987-1991	<b>FORD E-150 ECONOLINE</b>	4.9L L6 4917cc 300 CID	
	1980-1991	<b>FORD F800</b>	6.1L V8 370 CID			1987-1991	<b>FORD E-150 ECONOLINE CLUB WAGON</b>	4.9L L6 4917cc 300 CID	
	1980-1994	<b>FORD F600</b>	7.0L V8 429 CID			1987-1991	<b>FORD E-250 ECONOLINE</b>	4.9L L6 4917cc 300 CID	
	1980-1994	<b>FORD F700</b>	7.0L V8 429 CID			1987-1991	<b>FORD E-250 ECONOLINE CLUB WAGON</b>	4.9L L6 4917cc 300 CID	
	1988-1989	<b>FORD B600</b>	7.0L V8 429 CID			1987-1991	<b>FORD E-350 ECONOLINE</b>	4.9L L6 4917cc 300 CID	
	1988-1990	<b>FORD FT800</b>	6.1L V8 370 CID			1987-1991	<b>FORD E-350 ECONOLINE CLUB WAGON</b>	4.9L L6 4917cc 300 CID	
	1988-1990	<b>FORD FT800</b>	7.0L V8 429 CID			1987-1992	<b>FORD BRONCO</b>	4.9L L6 4917cc 300 CID	
	1988-1990	<b>FORD FT800</b>	7.0L V8 429 CID			1987-1992	<b>FORD F-150</b>	4.9L L6 4917cc 300 CID	
	1997-1998	<b>FORD F800</b>	7.0L V8 429 CID			1987-1992	<b>FORD F-250</b>	4.9L L6 4917cc 300 CID	
	<b>US4038</b>	1985-1992	<b>LINCOLN MARK VII</b>		5.0L V8 302 CID	<b>US4049</b>	1986	<b>MAZDA FAMILIA</b>	1.5L L4 1490cc 91 CID
		1986	<b>MERCURY CAPRI</b>		5.0L V8 302 CID		1986	<b>MAZDA FAMILIA</b>	1.6L L4 1597cc 97 CID
		1986-1987	<b>LINCOLN CONTINENTAL</b>		5.0L V8 302 CID		1986-1994	<b>MAZDA 323</b>	1.6L L4 1597cc
		1986-1988	<b>FORD THUNDERBIRD</b>		5.0L V8 302 CID		1988-1989	<b>MERCURY TRACER</b>	1.6L L4 1598cc 98 CID
		1986-1988	<b>MERCURY COUGAR</b>		5.0L V8 302 CID		1988-1993	<b>FORD FESTIVA</b>	1.3L L4 1295cc
1986-1993	<b>FORD MUSTANG</b>	5.0L V8 302 CID	1990-1994	<b>MAZDA PROTEGE</b>	1.8L L4 1839cc				
<b>US4038H</b>	1985-1992	<b>LINCOLN MARK VII</b>	5.0L V8 302 CID	1992-1993	<b>MAZDA MX-3</b>		1.6L L4 1597cc		
	1986	<b>MERCURY CAPRI</b>	5.0L V8 302 CID	1994-1995	<b>KIA SEPHIA</b>		1.6L L4 1597cc		
	1986-1987	<b>LINCOLN CONTINENTAL</b>	5.0L V8 302 CID	1994-1997	<b>FORD ASPIRE</b>		1.3L L4 1295cc		
	1986-1988	<b>FORD THUNDERBIRD</b>	5.0L V8 302 CID	<b>US4050</b>	1988-1989		<b>FORD COUGAR</b>	3.8L V6 3800cc 232 CID	
	1986-1988	<b>MERCURY COUGAR</b>	5.0L V8 302 CID		1988-1993	<b>FORD COUGAR</b>	3.8L V6 3802cc 232 CID		
1986-1993	<b>FORD MUSTANG</b>	5.0L V8 302 CID	1988-1993		<b>FORD THUNDERBIRD</b>	3.8L V6 232 CID			
<b>US4039</b>	1986-1994	<b>FORD AEROSTAR</b>	3.0L V6 2986cc 182 CID		1988-1993	<b>MERCURY COUGAR</b>	3.8L V6 232 CID		
	1991-1994	<b>FORD RANGER</b>	3.0L V6 2986cc 182 CID		1990-1994	<b>FORD COUGAR</b>	3.8L V6 3797cc 232 CID		
	1994	<b>MAZDA B3000</b>	3.0L V6 2986cc 182 CID		<b>US4051</b>	1988-1993	<b>FORD TAURUS</b>	3.8L V6 232 CID	
	<b>US4040</b>	1981-1985	<b>FORD ESCORT</b>			1.6L L4 1598cc 98 CID	1988-1993	<b>LINCOLN CONTINENTAL</b>	3.8L V6 232 CID
		1981-1985	<b>MERCURY LYNX</b>			1.6L L4 1598cc 98 CID	1988-1993	<b>MERCURY SABLE</b>	3.8L V6 232 CID
1982-1983		<b>MERCURY LN7</b>	1.6L L4 1598cc 98 CID		1991-1993	<b>FORD F150</b>	3.8L V6 3800cc 232 CID		
1982-1985		<b>FORD EXP</b>	1.6L L4 1598cc 98 CID		<b>US4052</b>	1979-1980	<b>FORD LTD</b>	5.8L V8 5800cc 351 CID	
1985-1987		<b>MERCURY LYNX</b>	1.9L L4 116 CID	1979-1981		<b>MERCURY GRAND MARQUIS</b>	5.8L V8 5800cc 351 CID		
1985-1990	<b>FORD ESCORT</b>	1.9L L4 116 CID	1988-1990	<b>LINCOLN TOWN CAR</b>		5.0L V8 302 CID			
1986-1988	<b>FORD EXP</b>	1.9L L4 116 CID	1988-1991	<b>FORD COUNTRY SQUIRE</b>		5.0L V8 302 CID			
<b>US4041</b>	1991-1992	<b>FORD GHIA</b>	2.3L L4 2300cc 140 CID	1988-1991		<b>FORD LTD CROWN VICTORIA</b>	5.0L V8 302 CID		
	1992-1994	<b>FORD TEMPO</b>	2.3L L4 140 CID	1988-1991	<b>MERCURY COLONY PARK</b>	5.0L V8 302 CID			
	1992-1994	<b>FORD TOPAZ</b>	2.3L L4 2294cc 140 CID	1988-1991	<b>MERCURY GRAND MARQUIS</b>	5.0L V8 302 CID			
	1992-1994	<b>MERCURY TOPAZ</b>	2.3L L4 140 CID	1991-1992	<b>FORD GRAND MARQUIS</b>	5.0L V8 5000cc 302 CID			
	<b>US4042</b>	1986-1990	<b>FORD BRONCO II</b>	2.9L V6 177 CID	<b>US4052H</b>	1988-1990	<b>LINCOLN TOWN CAR</b>	5.0L V8 302 CID	
1986-1992		<b>FORD RANGER</b>	2.9L V6 177 CID	1988-1991		<b>FORD COUNTRY SQUIRE</b>	5.0L V8 302 CID		
1988-1989		<b>MERKUR SCORPIO</b>	2.9L V6 177 CID	1988-1991		<b>FORD LTD CROWN VICTORIA</b>	5.0L V8 302 CID		
1997		<b>FORD BRONCO</b>	2.9L L6 2901cc 177 CID	1988-1991		<b>MERCURY COLONY PARK</b>	5.0L V8 302 CID		
<b>US4044</b>		1986-1990	<b>FORD F150</b>	5.0L V8 5000cc 302 CID		1988-1991	<b>MERCURY GRAND MARQUIS</b>	5.0L V8 302 CID	
	1986-1990	<b>FORD F200</b>	5.0L V8 5000cc 302 CID	<b>US4053</b>		1987-1993	<b>MAZDA B2200</b>	2.2L L4 2184cc	
	1986-1990	<b>FORD F200</b>	5.8L V8 5800cc 351 CID			1988-1992	<b>MAZDA 626</b>	2.2L L4 2184cc	
	1987-1989	<b>FORD F-250</b>	5.0L V8 302 CID			1988-1992	<b>MAZDA MX-6</b>	2.2L L4 2184cc	
	1987-1990	<b>FORD F350</b>	5.8L V8 5800cc 351 CID			1989-1992	<b>FORD PROBE</b>	2.2L L4 133 CID	
	1987-1991	<b>FORD E-250 ECONOLINE</b>	5.0L V8 302 CID			1995	<b>KIA SPORTAGE</b>	2.0L L4 1998cc 122 CID	
	1987-1992	<b>FORD B200</b>	5.0L V8 5000cc 302 CID		<b>US4054</b>	1983	<b>FORD FAIRMONT</b>	2.3L L4 140 CID	
	1987-1992	<b>FORD F350</b>	5.0L V8 5000cc 302 CID			1983	<b>MERCURY ZEPHYR</b>	2.3L L4 140 CID	
	1987-1996	<b>FORD BRONCO</b>	5.0L V8 302 CID			1983-1986	<b>FORD LTD</b>	2.3L L4 140 CID	
	1987-1996	<b>FORD E-150 ECONOLINE</b>	5.0L V8 302 CID			1983-1986	<b>MERCURY CAPRI</b>	2.3L L4 140 CID	
	1987-1996	<b>FORD E-150 ECONOLINE CLUB WAGON</b>	5.0L V8 302 CID			1983-1986	<b>MERCURY MARQUIS</b>	2.3L L4 140 CID	
	1987-1996	<b>FORD F-150</b>	5.0L V8 302 CID	1983-1988		<b>FORD RANGER</b>	2.0L L4 1989cc 122 CID		
	1988-1991	<b>FORD E-250 ECONOLINE CLUB WAGON</b>	5.8L V8 351 CID	1983-1988		<b>FORD THUNDERBIRD</b>	2.3L L4 140 CID		
	1988-1996	<b>FORD BRONCO</b>	5.8L V8 351 CID	1983-1993		<b>FORD MUSTANG</b>	2.3L L4 140 CID		
	1988-1996	<b>FORD E-150 ECONOLINE</b>	5.8L V8 351 CID	1983-1994		<b>FORD RANGER</b>	2.3L L4 140 CID		
	1988-1996	<b>FORD E-150 ECONOLINE CLUB WAGON</b>	5.8L V8 351 CID	1984-1986		<b>MERCURY COUGAR</b>	2.3L L4 140 CID		
	1988-1996	<b>FORD E-250 ECONOLINE</b>	5.8L V8 351 CID	1985-1989	<b>MERKUR XR4TI</b>	2.3L L4 140 CID			
	1988-1996	<b>FORD E-350 ECONOLINE</b>	5.8L V8 351 CID	1986-1987	<b>FORD AEROSTAR</b>	2.3L L4 140 CID			
	1988-1996	<b>FORD E-350 ECONOLINE CLUB WAGON</b>	5.8L V8 351 CID	1994	<b>MAZDA B2300</b>	2.3L L4 140 CID			
	1988-1996	<b>FORD F-150</b>	5.8L V8 351 CID	<b>US4055</b>	1990	<b>MERCURY COUGAR</b>	3.8L V6 232 CID		
	1988-1996	<b>FORD F-250</b>	5.8L V8 351 CID		1990-1995	<b>FORD THUNDERBIRD</b>	3.8L V6 232 CID		
	1988-1997	<b>FORD F-350</b>	5.8L V8 351 CID		<b>US4056</b>	1986	<b>MERCURY SABLE</b>	2.5L L4 153 CID	
	1988-1997	<b>FORD P350</b>	5.8L V8 5800cc 351 CID						
1989-1991	<b>FORD P350</b>	5.0L V8 5000cc 302 CID							
1991-1996	<b>FORD F-250</b>	5.0L V8 302 CID							



USMW	Years	Application	Engine	USMW	Years	Application	Engine
<b>US4056</b>	1986-1991	<b>FORD TAURUS</b>	2.5L L4 153 CID	<b>US4088</b>	1994-1995	<b>FORD MYSTIQUE</b>	2.0L L4 1984cc 121 CID
<b>US4057</b>	1991-1993	<b>FORD COUGAR</b>	5.0L V8 5000cc 302 CID	1995-1997	<b>FORD CONTOUR</b>	2.0L L4 1989cc 121 CID	
	1991-1993	<b>FORD THUNDERBIRD</b>	5.0L V8 302 CID	1995-1997	<b>MERCURY MYSTIQUE</b>	2.0L L4 1989cc 121 CID	
	1991-1993	<b>MERCURY COUGAR</b>	5.0L V8 302 CID	<b>US4089</b>	1994	<b>FORD WINDSTAR</b>	3.8L V6 3800cc 232 CID
	1994	<b>FORD COUGAR</b>	4.9L V8 4900cc 299 CID	1994	<b>LINCOLN CONTINENTAL</b>	3.8L V6 232 CID	
<b>US4059</b>	1990-1992	<b>FORD PROBE</b>	3.0L V6 2986cc 182 CID	1994-1995	<b>FORD F150</b>	3.8L V6 3800cc 232 CID	
<b>US4060</b>	1990	<b>FORD EXPLORER</b>	4.0L L6 4018cc 245 CID	1994-1995	<b>FORD SABLE</b>	3.8L V6 3800cc 232 CID	
	1990-1997	<b>FORD AEROSTAR</b>	4.0L V6 245 CID	1994-1995	<b>FORD TAURUS</b>	3.8L V6 232 CID	
	1990-2000	<b>FORD RANGER</b>	4.0L V6 245 CID	1994-1995	<b>MERCURY SABLE</b>	3.8L V6 232 CID	
	1991-1994	<b>MAZDA NAVAJO</b>	4.0L V6 4016cc	1995	<b>FORD WINDSTAR</b>	3.8L V6 232 CID	
	1991-2000	<b>FORD EXPLORER</b>	4.0L V6 245 CID	<b>US4090</b>	1994-1995	<b>FORD COUGAR</b>	3.8L V6 3802cc 232 CID
	1994-2000	<b>MAZDA B4000</b>	4.0L V6 4016cc	1994-1995	<b>FORD MUSTANG</b>	3.8L V6 232 CID	
<b>US4061</b>	1989-1995	<b>FORD TAURUS</b>	3.0L V6 2986cc 182 CID	1994-1995	<b>FORD THUNDERBIRD</b>	3.8L V6 232 CID	
<b>US4062</b>	1986-1990	<b>FORD CF6000</b>	6.6L L6 401 CID	1994-1995	<b>MERCURY COUGAR</b>	3.8L V6 232 CID	
	1986-1990	<b>FORD CF7000</b>	6.6L L6 401 CID	<b>US4091</b>	1995-2000	<b>FORD CONTOUR</b>	2.5L V6 2450cc 155 CID
	1986-1990	<b>FORD F600</b>	6.6L L6 401 CID	1995-2000	<b>FORD MYSTIQUE</b>	2.5L V6 2544cc 155 CID	
	1986-1990	<b>FORD F700</b>	6.6L L6 401 CID	1995-2000	<b>MERCURY MYSTIQUE</b>	2.5L V6 2450cc 155 CID	
	1986-1990	<b>FORD F800</b>	7.8L L6 473 CID	1999-2002	<b>MERCURY COUGAR</b>	2.5L V6 2450cc 155 CID	
	1987	<b>FORD B700</b>	7.8L L6 473 CID	2000-2001	<b>MAZDA MPV</b>	2.5L V6 2450cc 155 CID	
	1987	<b>FORD CF8000</b>	6.6L L6 401 CID	2001-2003	<b>FORD ESCAPE</b>	3.0L V6 2968cc 181 CID	
	1987-1988	<b>FORD LN7000</b>	7.8L L6 473 CID	2001-2003	<b>FORD TAURUS</b>	3.0L V6 2968cc 181 CID	
	1987-1989	<b>FORD F600</b>	7.8L L6 473 CID	2001-2003	<b>MERCURY SABLE</b>	3.0L V6 2968cc 181 CID	
	1987-1990	<b>FORD B600</b>	6.6L L6 401 CID	2001-2004	<b>MAZDA TRIBUTE</b>	3.0L V6 2968cc 181 CID	
	1987-1990	<b>FORD B700</b>	6.6L L6 401 CID	2001-2007	<b>FORD MONDEO</b>	2.5L V6 2544cc 155 CID	
	1987-1990	<b>FORD CF8000</b>	7.8L L6 473 CID	2002-2003	<b>MAZDA MPV</b>	3.0L V6 2968cc 181 CID	
	1987-1990	<b>FORD F700</b>	7.8L L6 473 CID	2005	<b>FORD MONDEO</b>	3.0L V6 2966cc 181 CID	
	1987-1990	<b>FORD F800</b>	6.6L L6 401 CID	<b>US4091-2</b>	1995-2000	<b>FORD CONTOUR</b>	2.5L V6 2450cc 155 CID
	1987-1990	<b>FORD LN7000</b>	6.6L L6 401 CID	1995-2000	<b>MERCURY MYSTIQUE</b>	2.5L V6 2450cc 155 CID	
	1987-1990	<b>FORD LN8000</b>	7.8L L6 473 CID	1999-2002	<b>MERCURY COUGAR</b>	2.5L V6 2450cc 155 CID	
	1990	<b>FORD B700</b>	7.8L L6 473 CID	2001-2003	<b>FORD ESCAPE</b>	3.0L V6 2968cc 181 CID	
	1990	<b>FORD F600 LPO</b>	6.6L L6 401 CID	2001-2003	<b>FORD TAURUS</b>	3.0L V6 2968cc 181 CID	
<b>US4065</b>	1991	<b>FORD ESCORT</b>	1.9L L4 116 CID	2001-2003	<b>MERCURY SABLE</b>	3.0L V6 2968cc 181 CID	
	1991	<b>MERCURY TRACER</b>	1.9L L4 116 CID	<b>US4093</b>	1995-1997	<b>FORD RANGER</b>	2.3L L4 140 CID
<b>US4066</b>	1991-1997	<b>LINCOLN TOWN CAR</b>	4.6L V8 281 CID	1995-1997	<b>MAZDA B2300</b>	2.3L L4 140 CID	
	1992-1997	<b>FORD CROWN VICTORIA</b>	4.6L V8 281 CID	1998-2001	<b>FORD RANGER</b>	2.5L L4 153 CID	
	1992-1997	<b>FORD GRAND MARQUIS</b>	4.6L V8 4608cc 281 CID	1998-2001	<b>MAZDA B2500</b>	2.5L L4 2492cc	
	1992-1997	<b>MERCURY GRAND MARQUIS</b>	4.6L V8 281 CID	<b>US4094</b>	1995-2000	<b>FORD WINDSTAR</b>	3.0L V6 2966cc 182 CID
<b>US4068</b>	1988-1989	<b>MAZDA 323</b>	1.6L L4 1597cc	1995-2005	<b>MERCURY SABLE</b>	3.0L V6 2966cc 182 CID	
	1990-1992	<b>MAZDA PROTEGE</b>	1.8L L4 1839cc	1995-2007	<b>FORD TAURUS</b>	3.0L V6 2966cc 182 CID	
	1990-1993	<b>MAZDA MIATA</b>	1.6L L4 1597cc	1996-1997	<b>FORD SABLE</b>	3.0L V6 3000cc 183 CID	
	1991-1994	<b>MERCURY CAPRI</b>	1.6L L4 1598cc 98 CID	1998-2002	<b>FORD SABLE</b>	3.0L V6 2966cc 181 CID	
	1991-1996	<b>FORD ESCORT</b>	1.8L L4 112 CID	2003	<b>MERCURY SABLE</b>	3.0L V6 2968cc 181 CID	
	1991-1996	<b>MERCURY TRACER</b>	1.8L L4 112 CID	<b>US4095</b>	1995-1996	<b>MAZDA B3000</b>	3.0L V6 2966cc 182 CID
<b>US4069</b>	1991-1996	<b>FORD ESCORT</b>	1.9L L4 116 CID	1995-1997	<b>FORD AEROSTAR</b>	3.0L V6 2966cc 182 CID	
	1991-1996	<b>MERCURY TRACER</b>	1.9L L4 116 CID	1995-2008	<b>FORD RANGER</b>	3.0L V6 2966cc 182 CID	
	1996-1997	<b>FORD VAGONETA</b>	1.9L L4 1900cc 114 CID	1998-2007	<b>MAZDA B3000</b>	3.0L V6 2966cc 182 CID	
<b>US4070</b>	1992-1993	<b>FORD TOPAZ</b>	3.0L V6 2985cc 182 CID	<b>US4096</b>	1994	<b>FORD F59</b>	7.3L V8 445 CID
	1992-1994	<b>FORD GHIA</b>	3.0L V6 2985cc 182 CID	1994-1996	<b>FORD F-250</b>	7.3L V8 445 CID	
	1992-1994	<b>FORD TEMPO</b>	3.0L V6 2986cc 182 CID	1994-1996	<b>FORD F-350</b>	7.3L V8 445 CID	
	1992-1994	<b>MERCURY TOPAZ</b>	3.0L V6 2986cc 182 CID	1995-1996	<b>FORD E-350 ECONOLINE</b>	7.3L V8 445 CID	
<b>US4077</b>	1992-1994	<b>FORD E-350 ECONOLINE</b>	7.5L V8 460 CID	1995-1996	<b>FORD E-350 ECONOLINE CLUB WAGON</b>	7.3L V8 445 CID	
	1992-1994	<b>FORD E-350 ECONOLINE CLUB WAGON</b>	7.5L V8 460 CID	1995-1996	<b>FORD F SUPER DUTY</b>	7.3L V8 445 CID	
	1992-1994	<b>FORD F-250</b>	7.5L V8 460 CID	1996	<b>FORD ECONOLINE SUPER DUTY</b>	7.3L V8 445 CID	
	1992-1994	<b>FORD F-350</b>	7.5L V8 460 CID	<b>US4097</b>	1995-2002	<b>LINCOLN CONTINENTAL</b>	4.6L V8 281 CID
	1992-1994	<b>FORD F SUPER DUTY</b>	7.5L V8 460 CID	<b>US4098</b>	1996-2000	<b>FORD TAURUS</b>	3.0L V6 2968cc 181 CID
<b>US4078</b>	1993-1997	<b>FORD PROBE</b>	2.0L L4 1989cc 122 CID	1996-2000	<b>MERCURY SABLE</b>	3.0L V6 2968cc 181 CID	
	1993-1997	<b>MAZDA MX-6</b>	2.0L L4 1991cc	<b>US4099</b>	1993-1994	<b>FORD F-350</b>	4.9L L6 4917cc 300 CID
	1993-2002	<b>MAZDA 626</b>	2.0L L4 1991cc	1993-1996	<b>FORD E-150 ECONOLINE</b>	4.9L L6 4917cc 300 CID	
	1999-2000	<b>MAZDA PROTEGE</b>	1.8L L4 1839cc	1993-1996	<b>FORD E-150 ECONOLINE CLUB WAGON</b>	4.9L L6 4917cc 300 CID	
	2001-2003	<b>MAZDA PROTEGE</b>	2.0L L4 2000cc	1993-1996	<b>FORD E-250 ECONOLINE</b>	4.9L L6 4917cc 300 CID	
	2002-2003	<b>MAZDA PROTEGE5</b>	2.0L L4 2000cc	1993-1996	<b>FORD E-350 ECONOLINE</b>	4.9L L6 4917cc 300 CID	
<b>US4079</b>	1992	<b>FORD E-150 ECONOLINE</b>	4.9L L6 4917cc 300 CID	1993-1996	<b>FORD E-350 ECONOLINE CLUB WAGON</b>	4.9L L6 4917cc 300 CID	
	1992	<b>FORD E-150 ECONOLINE CLUB WAGON</b>	4.9L L6 4917cc 300 CID	1993-1996	<b>FORD F-150</b>	4.9L L6 4917cc 300 CID	
	1992	<b>FORD E-250 ECONOLINE</b>	4.9L L6 4917cc 300 CID	1993-1996	<b>FORD F-250</b>	4.9L L6 4917cc 300 CID	
	1992	<b>FORD E-350 ECONOLINE</b>	4.9L L6 4917cc 300 CID	1997	<b>FORD F150</b>	4.9L L6 4900cc 300 CID	
	1992	<b>FORD E-350 ECONOLINE CLUB WAGON</b>	4.9L L6 4917cc 300 CID	<b>US4101</b>	1996-2001	<b>FORD EXPLORER</b>	5.0L V8 302 CID
<b>US4081</b>	1987-1989	<b>FORD E-350 ECONOLINE</b>	7.5L V8 460 CID	1997-2001	<b>MERCURY MOUNTAINEER</b>	5.0L V8 302 CID	
	1988-1989	<b>FORD E-250 ECONOLINE CLUB WAGON</b>	7.5L V8 460 CID	<b>US4102</b>	1996-2003	<b>FORD WINDSTAR</b>	3.8L V6 232 CID
	1988-1989	<b>FORD E-350 ECONOLINE CLUB WAGON</b>	7.5L V8 460 CID	2004-2007	<b>FORD FREESTAR</b>	3.9L V6 238 CID	
	1988-1989	<b>FORD F-250</b>	7.5L V8 460 CID	2004-2007	<b>FORD FREESTAR</b>	4.2L V6 256 CID	
	1988-1989	<b>FORD F-350</b>	7.5L V8 460 CID	2004-2007	<b>MERCURY MONTEREY</b>	4.2L V6 256 CID	
<b>US4082</b>	1993-1995	<b>FORD TAURUS</b>	3.2L V6 195 CID	<b>US4103</b>	1996	<b>FORD COUGAR</b>	3.8L L6 3802cc 232 CID
<b>US4083</b>	1984	<b>FORD E-250 ECONOLINE</b>	4.9L L6 4917cc 300 CID	1996-1997	<b>FORD THUNDERBIRD</b>	3.8L V6 232 CID	
	1984	<b>FORD E-250 ECONOLINE CLUB WAGON</b>	4.9L L6 4917cc 300 CID	1996-1997	<b>MERCURY COUGAR</b>	3.8L V6 232 CID	
	1984	<b>FORD E-350 ECONOLINE</b>	4.9L L6 4917cc 300 CID	1996-2004	<b>FORD MUSTANG</b>	3.8L V6 232 CID	
	1984	<b>FORD E-350 ECONOLINE CLUB WAGON</b>	4.9L L6 4917cc 300 CID	2004	<b>FORD MUSTANG</b>	3.9L V6 238 CID	
<b>US4086</b>	1995-1996	<b>FORD E-350 ECONOLINE</b>	7.5L V8 460 CID	<b>US4104</b>	1998-2000	<b>FORD FIESTA</b>	1.4L L4 1388cc 85 CID
	1995-1996	<b>FORD E-350 ECONOLINE CLUB WAGON</b>	7.5L V8 460 CID	<b>US4105</b>	1997-2002	<b>FORD E-150 ECONOLINE</b>	4.2L V6 256 CID
	1995-1997	<b>FORD F-250</b>	7.5L V8 460 CID	1997-2002	<b>FORD E-150 ECONOLINE CLUB WAGON</b>	4.2L V6 256 CID	
	1995-1997	<b>FORD F-350</b>	7.5L V8 460 CID	1997-2002	<b>FORD E-250 ECONOLINE</b>	4.2L V6 256 CID	
	1995-1997	<b>FORD F SUPER DUTY</b>	7.5L V8 460 CID	1997-2003	<b>FORD F-150</b>	4.2L V6 256 CID	
	1996	<b>FORD ECONOLINE SUPER DUTY</b>	7.5L V8 460 CID	1999-2002	<b>FORD ECONOLINE WAGON</b>	4.2L V6 4195cc 256 CID	
<b>US4087</b>	1994-1995	<b>FORD MUSTANG</b>	5.0L V8 302 CID	2003	<b>FORD E-150</b>	4.2L V6 256 CID	
				2003	<b>FORD E-150 CLUB WAGON</b>	4.2L V6 256 CID	
				2003	<b>FORD E-250</b>	4.2L V6 256 CID	
				2004	<b>FORD F-150 HERITAGE</b>	4.2L V6 256 CID	

WATER PUMPS

USMW	Years	Application	Engine	USMW	Years	Application	Engine
<b>US4105</b>	2005-2008	<b>FORD F-150</b>	4.2L V6 256 CID	<b>US4124</b>	2002-2005	<b>FORD THUNDERBIRD</b>	3.9L V8 242 CID
<b>US4106</b>	1996-1999	<b>FORD TAURUS</b>	3.4L V8 207 CID	2003-2006	<b>JAGUAR XK8</b>		4.2L V8 4196cc
<b>US4107</b>	1997-1999	<b>MERCURY TRACER</b>	2.0L L4 1989cc 121 CID	2003-2008	<b>JAGUAR S-TYPE</b>		4.2L V8 4196cc
	1997-2002	<b>FORD ESCORT</b>	2.0L L4 1989cc 121 CID	2003-2009	<b>JAGUAR XKR</b>		4.2L V8 4196cc
<b>US4108</b>	1997-2010	<b>FORD EXPLORER</b>	4.0L V6 245 CID	2004-2009	<b>JAGUAR VANDEN PLAS</b>		4.2L V8 4196cc
	1998-2010	<b>MERCURY MOUNTAINEER</b>	4.0L V6 245 CID	2004-2009	<b>JAGUAR XJ8</b>		4.2L V8 4196cc
	2001-2005	<b>FORD EXPLORER SPORT TRAC</b>	4.0L V6 245 CID	2004-2009	<b>JAGUAR XJR</b>		4.2L V8 4196cc
	2001-2009	<b>MAZDA B4000</b>	4.0L V6 4016cc	2005-2009	<b>JAGUAR SUPER V8</b>		4.2L V8 4196cc
	2001-2011	<b>FORD RANGER</b>	4.0L V6 245 CID	2005-2009	<b>LAND ROVER LR3</b>		4.4L V8 4394cc
	2005-2010	<b>FORD MUSTANG</b>	4.0L V6 245 CID	2006-2009	<b>LAND ROVER RANGE ROVER</b>		4.2L V8 4196cc
	2007-2010	<b>FORD EXPLORER SPORT TRAC</b>	4.0L V6 245 CID	2006-2009	<b>LAND ROVER RANGE ROVER</b>		4.4L V8 4394cc
<b>US4109</b>	1997-1998	<b>FORD E-350 ECONOLINE</b>	6.8L V10 415 CID	2006-2009	<b>LAND ROVER RANGE ROVER SPORT</b>		4.2L V8 4196cc
	1997-1999	<b>FORD ECONOLINE SUPER DUTY</b>	6.8L V10 415 CID	2006-2009	<b>LAND ROVER RANGE ROVER SPORT</b>		4.4L V8 4394cc
	1997-2002	<b>FORD E-350 ECONOLINE CLUB WAGON</b>	6.8L V10 415 CID	2007-2009	<b>JAGUAR XK</b>		4.2L V8 4196cc
	1999-2008	<b>FORD F-450 SUPER DUTY</b>	6.8L V10 415 CID	2009-2010	<b>JAGUAR XF</b>		4.2L V8 4196cc
	1999-2008	<b>FORD F-550 SUPER DUTY</b>	6.8L V10 415 CID	<b>US4125</b>	1999-2010	<b>FORD LOBO</b>	5.4L V8 5409cc 330 CID
	1999-2009	<b>FORD E-350 SUPER DUTY</b>	6.8L V10 415 CID	2001-2003	<b>FORD F-150</b>		5.4L V8 330 CID
	1999-2009	<b>FORD F-250 SUPER DUTY</b>	6.8L V10 415 CID	2004	<b>FORD F-150 HERITAGE</b>		5.4L V8 330 CID
	1999-2009	<b>FORD F-350 SUPER DUTY</b>	6.8L V10 415 CID	2007	<b>FORD LOBO</b>		4.6L V8 4608cc 281 CID
	2000-2002	<b>FORD E-450 ECONOLINE SUPER DUTY</b>	6.8L V10 415 CID	<b>US4126</b>	2001-2007	<b>FORD MONDEO</b>	2.0L L4 1999cc 122 CID
	2000-2005	<b>FORD EXCURSION</b>	6.8L V10 415 CID	2001-2009	<b>MAZDA B2300</b>		2.3L L4 140 CID
	2002	<b>FORD E-550 ECONOLINE SUPER DUTY</b>	6.8L V10 415 CID	2001-2011	<b>FORD RANGER</b>		2.3L L4 140 CID
	2003	<b>FORD E-350 CLUB WAGON</b>	6.8L V10 415 CID	2003-2007	<b>FORD FOCUS</b>		2.3L L4 140 CID
	2003	<b>FORD E-550 SUPER DUTY</b>	6.8L V10 415 CID	2003-2008	<b>MAZDA 6</b>		2.3L L4 2260cc
	2003-2009	<b>FORD E-450 SUPER DUTY</b>	6.8L V10 415 CID	2004-2005	<b>MAZDA 3</b>		2.0L L4 2000cc 122 CID
	2005	<b>FORD E-350 CLUB WAGON</b>	6.8L V10 415 CID	2004-2005	<b>MAZDA 3</b>		2.3L L4 2260cc
	2014	<b>FORD F-450</b>	6.8L V10 6751cc 412 CID	2005-2006	<b>MAZDA TRIBUTE</b>		2.3L L4 140 CID
	2014	<b>FORD F-550</b>	6.8L V10 6751cc 412 CID	2005-2008	<b>FORD ESCAPE</b>		2.3L L4 140 CID
	2015-2018	<b>FORD F53</b>	6.8L V10 415 CID	2005-2008	<b>MERCURY MARINER</b>		2.3L L4 140 CID
	2015-2018	<b>FORD F59</b>	6.8L V10 415 CID	2005-2011	<b>FORD ECOSPORT</b>		2.0L L4 1999cc 122 CID
	2016-2017	<b>FORD E-450 SUPER DUTY</b>	6.8L V10 415 CID	2005-2018	<b>FORD FOCUS</b>		2.0L L4 1999cc 122 CID
	2016-2018	<b>FORD E-350 SUPER DUTY</b>	6.8L V10 415 CID	2006-2007	<b>MAZDA 5</b>		2.3L L4 2260cc
	2016-2018	<b>FORD F-450 SUPER DUTY</b>	6.8L V10 415 CID	2006-2009	<b>FORD FUSION</b>		2.3L L4 140 CID
	2016-2018	<b>FORD F-550 SUPER DUTY</b>	6.8L V10 415 CID	2006-2009	<b>MERCURY MILAN</b>		2.3L L4 140 CID
<b>US4113</b>	1993-1998	<b>LINCOLN MARK VIII</b>	4.6L V8 281 CID	2007-2011	<b>FORD FOCUS</b>		2.0L L4 1989cc 121 CID
	1994-1997	<b>FORD THUNDERBIRD</b>	4.6L V8 281 CID	2007-2012	<b>MAZDA CX-7</b>		2.3L L4 2260cc
	1994-1997	<b>MERCURY COUGAR</b>	4.6L V8 281 CID	2007-2013	<b>MAZDA 3</b>		2.3L L4 2260cc
	1996-1998	<b>FORD MUSTANG</b>	4.6L V8 281 CID	2008	<b>MAZDA TRIBUTE</b>		2.3L L4 140 CID
	1998-2001	<b>FORD GRAND MARQUIS</b>	4.6L V8 4608cc 281 CID	2009-2010	<b>MAZDA 6</b>		2.5L L4 2488cc 152 CID
	1998-2002	<b>FORD CROWN VICTORIA</b>	4.6L V8 281 CID	2009-2011	<b>MAZDA TRIBUTE</b>		2.5L L4 2488cc 152 CID
	1998-2002	<b>LINCOLN TOWN CAR</b>	4.6L V8 281 CID	2009-2011	<b>MERCURY MARINER</b>		2.5L L4 2488cc 152 CID
	1998-2002	<b>MERCURY GRAND MARQUIS</b>	4.6L V8 281 CID	2009-2018	<b>FORD ESCAPE</b>		2.5L L4 2488cc 152 CID
	2005-2006	<b>FORD MUSTANG</b>	4.6L V8 281 CID	2010-2011	<b>MERCURY MILAN</b>		2.5L L4 2488cc 152 CID
<b>US4114</b>	1996	<b>FORD F-250</b>	7.3L V8 445 CID	2010-2013	<b>FORD TRANSIT CONNECT</b>		2.0L L4 1999cc 122 CID
	1996-1997	<b>FORD F-350</b>	7.3L V8 445 CID	2010-2018	<b>FORD FUSION</b>		2.5L L4 2488cc 152 CID
	1996-1997	<b>FORD F SUPER DUTY</b>	7.3L V8 445 CID	2011-2012	<b>LINCOLN MKZ</b>		2.5L L4 2488cc 152 CID
	1996-1998	<b>FORD E-350 ECONOLINE</b>	7.3L V8 445 CID	2012-2015	<b>FORD EDGE</b>		2.0L L4 1999cc 122 CID
	1996-1999	<b>FORD ECONOLINE SUPER DUTY</b>	7.3L V8 445 CID	2012-2015	<b>FORD EXPLORER</b>		2.0L L4 1999cc 122 CID
	1996-2002	<b>FORD E-350 ECONOLINE CLUB WAGON</b>	7.3L V8 445 CID	2013-2016	<b>FORD ESCAPE</b>		2.0L L4 1999cc 122 CID
	1999-2003	<b>FORD E-350 SUPER DUTY</b>	7.3L V8 445 CID	2013-2016	<b>FORD FUSION</b>		2.0L L4 1999cc 122 CID
	1999-2003	<b>FORD F-250 SUPER DUTY</b>	7.3L V8 445 CID	2013-2016	<b>LINCOLN MKT</b>		2.0L L4 1999cc 122 CID
	1999-2003	<b>FORD F-350 SUPER DUTY</b>	7.3L V8 445 CID	2013-2016	<b>LINCOLN MKZ</b>		2.0L L4 1999cc 122 CID
	1999-2003	<b>FORD F-450 SUPER DUTY</b>	7.3L V8 445 CID	2013-2017	<b>FORD TAURUS</b>		2.0L L4 1999cc 122 CID
	1999-2003	<b>FORD F-550 SUPER DUTY</b>	7.3L V8 445 CID	2014-2018	<b>FORD SPECIAL SERVICE POLICE SEDAN</b>		2.0L L4 1999cc 122 CID
	2000-2002	<b>FORD E-450 ECONOLINE SUPER DUTY</b>	7.3L V8 445 CID	2014-2018	<b>FORD TRANSIT CONNECT</b>		2.5L L4 2488cc 152 CID
	2000-2003	<b>FORD EXCURSION</b>	7.3L V8 445 CID	2015-2016	<b>LINCOLN MKC</b>		2.0L L4 1999cc 122 CID
	2002	<b>FORD E-550 ECONOLINE SUPER DUTY</b>	7.3L V8 445 CID	2018	<b>FORD ECOSPORT</b>		2.0L L4 1999cc 122 CID
	2003	<b>FORD E-350 CLUB WAGON</b>	7.3L V8 445 CID	<b>US4128</b>	2001-2004	<b>FORD MUSTANG</b>	4.6L V8 281 CID
	2003	<b>FORD E-450 SUPER DUTY</b>	7.3L V8 445 CID	2001-2011	<b>FORD CROWN VICTORIA</b>		4.6L V8 281 CID
	2003	<b>FORD E-550 SUPER DUTY</b>	7.3L V8 445 CID	2001-2011	<b>LINCOLN TOWN CAR</b>		4.6L V8 281 CID
<b>US4115</b>	1998-2000	<b>FORD CONTOUR</b>	2.0L L4 1989cc 121 CID	2001-2011	<b>MERCURY GRAND MARQUIS</b>		4.6L V8 281 CID
	1998-2000	<b>MERCURY MYSTIQUE</b>	2.0L L4 1989cc 121 CID	2002-2004	<b>FORD GRAND MARQUIS</b>		4.6L V8 4608cc 281 CID
	1998-2003	<b>FORD ESCORT</b>	2.0L L4 1989cc 121 CID	2003	<b>LINCOLN BLACKWOOD</b>		5.4L V8 5409cc 330 CID
	1999	<b>FORD CONTOUR</b>	2.5L V6 2450cc 155 CID	2003-2004	<b>MERCURY MARAUDER</b>		4.6L V8 281 CID
	1999-2002	<b>MERCURY COUGAR</b>	2.0L L4 1989cc 121 CID	<b>US4129</b>	2003-2005	<b>LINCOLN LS</b>	3.0L V6 2968cc 181 CID
	2000-2004	<b>FORD FOCUS</b>	2.0L L4 1989cc 121 CID	2003-2008	<b>JAGUAR S-TYPE</b>		3.0L V6 2968cc 181 CID
	2001-2004	<b>FORD ESCAPE</b>	2.0L L4 1989cc 121 CID	<b>US4132</b>	2003-2005	<b>FORD TAURUS</b>	3.0L V6 2968cc 181 CID
	2001-2004	<b>MAZDA TRIBUTE</b>	2.0L L4 1989cc 121 CID	2003-2005	<b>MERCURY SABLE</b>		3.0L V6 2968cc 181 CID
	2004	<b>FORD ECOSPORT</b>	2.0L L4 1984cc 121 CID	2003-2006	<b>FORD ESCAPE</b>		3.0L V6 2968cc 181 CID
<b>US4118</b>	2000-2002	<b>JAGUAR S-TYPE</b>	3.0L V6 2968cc 181 CID	2003-2006	<b>MAZDA MPV</b>		3.0L V6 2968cc 181 CID
	2000-2002	<b>LINCOLN LS</b>	3.0L V6 2968cc 181 CID	2005-2006	<b>MAZDA TRIBUTE</b>		3.0L V6 2968cc 181 CID
<b>US4119</b>	1999-2004	<b>FORD MUSTANG</b>	4.6L V8 281 CID	2005-2006	<b>MERCURY MARINER</b>		3.0L V6 2968cc 181 CID
	2007-2010	<b>FORD MUSTANG</b>	4.6L V8 281 CID	2008	<b>MAZDA TRIBUTE</b>		3.0L V6 2968cc 181 CID
<b>US4121</b>	1999-2001	<b>FORD F-150</b>	5.4L V8 330 CID	<b>US4132-2</b>	2003-2005	<b>FORD TAURUS</b>	3.0L V6 2968cc 181 CID
	2000	<b>FORD F350</b>	5.4L V8 5409cc 330 CID	2003-2005	<b>MERCURY SABLE</b>		3.0L V6 2968cc 181 CID
<b>US4123</b>	2000-2004	<b>FORD FOCUS</b>	2.0L L4 1989cc 121 CID	2003-2006	<b>FORD ESCAPE</b>		3.0L V6 2968cc 181 CID
<b>US4124</b>	1997-2002	<b>JAGUAR XK8</b>	4.0L V8 3996cc 244 CID	2005-2006	<b>MERCURY MARINER</b>		3.0L V6 2968cc 181 CID
	1998-2003	<b>JAGUAR VANDEN PLAS</b>	4.0L V8 3996cc 244 CID	<b>US5000</b>	1980-1983	<b>CHEVROLET CITATION</b>	2.5L L4 2474cc 151 CID
	1998-2003	<b>JAGUAR XJ8</b>	4.0L V8 3996cc 244 CID	1980-1984	<b>OLDSMOBILE OMEGA</b>		2.5L L4 2474cc 151 CID
	1998-2003	<b>JAGUAR XJR</b>	4.0L V8 3996cc 244 CID	1980-1984	<b>PONTIAC PHOENIX</b>		2.5L L4 2474cc 151 CID
	2000-2002	<b>JAGUAR S-TYPE</b>	4.0L V8 3996cc 244 CID	1980-1991	<b>BUICK SKYLARK</b>		2.5L L4 2474cc 151 CID
	2000-2002	<b>JAGUAR XKR</b>	4.0L V8 3996cc 244 CID	1982-1986	<b>BUICK CENTURY</b>		2.5L L4 2474cc 151 CID
	2000-2006	<b>LINCOLN LS</b>	3.9L V8 242 CID	1982-1986	<b>CHEVROLET CELEBRITY</b>		2.5L L4 2474cc 151 CID
				1982-1986	<b>OLDSMOBILE CUTLASS CIERA</b>		2.5L L4 2474cc 151 CID
				1982-1986	<b>PONTIAC 6000</b>		2.5L L4 2474cc 151 CID
				1984-1985	<b>CHEVROLET CITATION II</b>		2.5L L4 2474cc 151 CID
				1984-1988	<b>PONTIAC FIERO</b>		2.5L L4 2474cc 151 CID

USMW	Years	Application	Engine	USMW	Years	Application	Engine
<b>US5000</b>	1985	<b>BUICK SOMERSET REGAL</b>	2.5L L4 2474cc 151 CID	<b>US5008</b>	1982-1986	<b>GMC K2500 SUBURBAN</b>	6.2L V8 379 CID
	1985-1987	<b>OLDSMOBILE CALAIS</b>	2.5L L4 2474cc 151 CID		1982-1986	<b>GMC K3500</b>	6.2L V8 379 CID
	1985-1991	<b>PONTIAC GRAND AM</b>	2.5L L4 2474cc 151 CID		1982-1989	<b>CHEVROLET P20</b>	6.2L V8 379 CID
	1986-1987	<b>BUICK SOMERSET</b>	2.5L L4 2474cc 151 CID		1982-1989	<b>GMC P2500</b>	6.2L V8 379 CID
	1988-1991	<b>OLDSMOBILE CUTLASS CALAIS</b>	2.5L L4 2474cc 151 CID		1982-1991	<b>GMC JIMMY</b>	6.2L V8 379 CID
<b>US5000P</b>	1980-1983	<b>CHEVROLET CITATION</b>	2.5L L4 2474cc 151 CID	1982-1993	<b>CHEVROLET P30</b>	6.2L V8 379 CID	
	1980-1984	<b>OLDSMOBILE OMEGA</b>	2.5L L4 2474cc 151 CID	1982-1993	<b>GMC P3500</b>	6.2L V8 379 CID	
	1980-1984	<b>PONTIAC PHOENIX</b>	2.5L L4 2474cc 151 CID	1983-1993	<b>CHEVROLET G20</b>	6.2L V8 379 CID	
	1980-1985	<b>BUICK SKYLARK</b>	2.5L L4 2474cc 151 CID	1983-1993	<b>CHEVROLET G30</b>	6.2L V8 379 CID	
	1982-1986	<b>BUICK CENTURY</b>	2.5L L4 2474cc 151 CID	1983-1993	<b>GMC G2500</b>	6.2L V8 379 CID	
	1982-1986	<b>CHEVROLET CELEBRITY</b>	2.5L L4 2474cc 151 CID	1983-1993	<b>GMC G3500</b>	6.2L V8 379 CID	
	1982-1986	<b>OLDSMOBILE CUTLASS CIERA</b>	2.5L L4 2474cc 151 CID	1987	<b>CHEVROLET R10</b>	6.2L V8 379 CID	
	1982-1986	<b>PONTIAC 6000</b>	2.5L L4 2474cc 151 CID	1987	<b>CHEVROLET V10</b>	6.2L V8 379 CID	
	1984-1985	<b>CHEVROLET CITATION II</b>	2.5L L4 2474cc 151 CID	1987	<b>CHEVROLET V20</b>	6.2L V8 379 CID	
	1987	<b>BUICK SOMERSET</b>	2.5L L4 2474cc 151 CID	1987	<b>GMC R1500</b>	6.2L V8 379 CID	
	<b>US5001</b>	1980-1983	<b>CHEVROLET CITATION</b>	2.8L V6 173 CID	1987	<b>GMC R1500 SUBURBAN</b>	6.2L V8 379 CID
1980-1984		<b>OLDSMOBILE OMEGA</b>	2.8L V6 173 CID	1987	<b>GMC R2500 SUBURBAN</b>	6.2L V8 379 CID	
1980-1984		<b>PONTIAC PHOENIX</b>	2.8L V6 173 CID	1987	<b>GMC V1500</b>	6.2L V8 379 CID	
1980-1985		<b>BUICK SKYLARK</b>	2.8L V6 173 CID	1987	<b>GMC V1500 SUBURBAN</b>	6.2L V8 379 CID	
1982-1986		<b>CHEVROLET CELEBRITY</b>	2.8L V6 173 CID	1987	<b>GMC V2500</b>	6.2L V8 379 CID	
1982-1986		<b>PONTIAC 6000</b>	2.8L V6 173 CID	1987	<b>GMC V2500 SUBURBAN</b>	6.2L V8 379 CID	
1984-1985		<b>CHEVROLET CITATION II</b>	2.8L V6 173 CID	1987-1988	<b>CHEVROLET R10 SUBURBAN</b>	6.2L V8 379 CID	
1984-1988		<b>CHEVROLET CITATION</b>	2.8L V6 2800cc 173 CID	1987-1988	<b>CHEVROLET R20</b>	6.2L V8 379 CID	
1985-1986		<b>CHEVROLET CAMARO</b>	2.8L V6 173 CID	1987-1988	<b>CHEVROLET R20 SUBURBAN</b>	6.2L V8 379 CID	
1985-1986		<b>PONTIAC FIREBIRD</b>	2.8L V6 173 CID	1987-1988	<b>CHEVROLET R30</b>	6.2L V8 379 CID	
1985-1988		<b>PONTIAC FIERO</b>	2.8L V6 173 CID	1987-1988	<b>CHEVROLET V10 SUBURBAN</b>	6.2L V8 379 CID	
1986		<b>BUICK CENTURY</b>	2.8L V6 173 CID	1987-1988	<b>CHEVROLET V20 SUBURBAN</b>	6.2L V8 379 CID	
1986		<b>OLDSMOBILE CUTLASS CIERA</b>	2.8L V6 173 CID	1987-1988	<b>CHEVROLET V30</b>	6.2L V8 379 CID	
<b>US5003</b>		1968-1969	<b>CADILLAC ELDORADO</b>	7.7L V8 472 CID	1987-1989	<b>GMC R2500</b>	6.2L V8 379 CID
		1968-1969	<b>CADILLAC ELDORADO</b>	7.7L V8 7735cc 472 CID	1987-1991	<b>CHEVROLET BLAZER</b>	6.2L V8 379 CID
	1968-1973	<b>CADILLAC CALAIS</b>	7.7L V8 472 CID	1987-1991	<b>GMC R3500</b>	6.2L V8 379 CID	
	1968-1973	<b>CADILLAC CALAIS</b>	7.7L V8 7735cc 472 CID	1987-1991	<b>GMC V3500</b>	6.2L V8 379 CID	
	1968-1973	<b>CADILLAC COMMERCIAL CHASSIS</b>	7.7L V8 7735cc 472 CID	1989	<b>CHEVROLET R2500</b>	6.2L V8 379 CID	
	1968-1973	<b>CADILLAC DEVILLE</b>	7.7L V8 472 CID	1989-1991	<b>CHEVROLET R3500</b>	6.2L V8 379 CID	
	1968-1973	<b>CADILLAC DEVILLE</b>	7.7L V8 7735cc 472 CID	1989-1991	<b>CHEVROLET V3500</b>	6.2L V8 379 CID	
	1968-1973	<b>CADILLAC FLEETWOOD</b>	7.7L V8 472 CID	1992-1993	<b>AM GENERAL HUMMER</b>	6.2L V8 379 CID	
	1968-1973	<b>CADILLAC FLEETWOOD</b>	7.7L V8 7735cc 472 CID	<b>US5010</b>	1982-1984	<b>CADILLAC DEVILLE</b>	4.1L V8 250 CID
	1970-1973	<b>CADILLAC ELDORADO</b>	8.2L V8 500 CID		1982-1985	<b>CADILLAC ELDORADO</b>	4.1L V8 250 CID
	1970-1973	<b>CADILLAC ELDORADO</b>	8.2L V8 8193cc 500 CID		1982-1985	<b>CADILLAC FLEETWOOD</b>	4.1L V8 250 CID
	1972-1973	<b>CADILLAC ELDORADO</b>	8.2L V8 8195cc 500 CID	1982-1985	<b>CADILLAC SEVILLE</b>	4.1L V8 250 CID	
	1977-1978	<b>CADILLAC ELDORADO</b>	7.0L V8 425 CID	1982-1983	<b>CHEVROLET MALIBU</b>	4.3L V6 260 CID	
	1977-1979	<b>CADILLAC DEVILLE</b>	7.0L V8 425 CID	1982-1983	<b>CHEVROLET MONTE CARLO</b>	4.3L V6 260 CID	
	1977-1979	<b>CADILLAC FLEETWOOD</b>	7.0L V8 425 CID	1982-1984	<b>BUICK REGAL</b>	4.3L V6 260 CID	
	1980-1981	<b>CADILLAC DEVILLE</b>	6.0L V8 368 CID	1982-1984	<b>OLDSMOBILE CUTLASS CALAIS</b>	4.3L V6 260 CID	
	1980-1981	<b>CADILLAC ELDORADO</b>	6.0L V8 368 CID	1984	<b>OLDSMOBILE CUTLASS SUPREME</b>	4.3L V6 260 CID	
	1980-1981	<b>CADILLAC SEVILLE</b>	6.0L V8 368 CID	<b>US5013</b>	1982-1985	<b>CHEVROLET S10</b>	1.9L L4 119 CID
	1980-1984	<b>CADILLAC COMMERCIAL CHASSIS</b>	6.0L V8 368 CID		1982-1985	<b>GMC S15</b>	1.9L L4 119 CID
	1980-1984	<b>CADILLAC FLEETWOOD</b>	6.0L V8 368 CID		1983-1984	<b>CHEVROLET S10 BLAZER</b>	1.9L L4 119 CID
	<b>US5004</b>	1976-1987	<b>CHEVROLET CHEVETTE</b>	1.6L L4 98 CID	1983-1984	<b>GMC S15 JIMMY</b>	1.9L L4 119 CID
1981-1987		<b>PONTIAC T1000</b>	1.6L L4 98 CID	<b>US5014</b>	1982-1985	<b>BUICK CENTURY</b>	4.3L V6 260 CID
<b>US5006</b>	1982-1984	<b>CHEVROLET CAMARO</b>	2.8L V6 173 CID		1982-1985	<b>CHEVROLET CELEBRITY</b>	4.3L V6 260 CID
	1982-1984	<b>PONTIAC FIREBIRD</b>	2.8L V6 173 CID		1982-1985	<b>OLDSMOBILE CUTLASS CIERA</b>	4.3L V6 260 CID
	1982-1986	<b>CHEVROLET S10</b>	2.8L V6 173 CID		1982-1985	<b>PONTIAC 6000</b>	4.3L V6 260 CID
	1982-1986	<b>GMC S15</b>	2.8L V6 173 CID		1985	<b>BUICK ELECTRA</b>	4.3L V6 260 CID
	1983-1986	<b>CHEVROLET S10 BLAZER</b>	2.8L V6 173 CID		1985	<b>CADILLAC COMMERCIAL CHASSIS</b>	4.3L V6 260 CID
	1983-1986	<b>GMC S15 JIMMY</b>	2.8L V6 173 CID		1985	<b>CADILLAC DEVILLE</b>	4.3L V6 260 CID
	1984-1986	<b>JEEP CHEROKEE</b>	2.8L V6 173 CID		1985	<b>CADILLAC FLEETWOOD</b>	4.3L V6 260 CID
	1984-1986	<b>JEEP WAGONEER</b>	2.8L V6 173 CID		1985	<b>OLDSMOBILE 98</b>	4.3L V6 260 CID
1986	<b>JEEP COMANCHE</b>	2.8L V6 173 CID	<b>US5014P</b>		1982-1985	<b>BUICK CENTURY</b>	4.3L V6 260 CID
<b>US5007</b>	1982	<b>BUICK SKYHAWK</b>		1.8L L4 112 CID	1982-1985	<b>CHEVROLET CELEBRITY</b>	4.3L V6 260 CID
	1982	<b>CADILLAC CIMARRON</b>		1.8L L4 112 CID	1982-1985	<b>OLDSMOBILE CUTLASS CIERA</b>	4.3L V6 260 CID
	1982	<b>CHEVROLET CAVALIER</b>		1.8L L4 112 CID	1982-1985	<b>PONTIAC 6000</b>	4.3L V6 260 CID
	1982	<b>OLDSMOBILE FIRENZA</b>		1.8L L4 112 CID	1985	<b>BUICK ELECTRA</b>	4.3L V6 260 CID
	1982	<b>PONTIAC J2000</b>		1.8L L4 112 CID	1985	<b>CADILLAC COMMERCIAL CHASSIS</b>	4.3L V6 260 CID
	1983-1986	<b>BUICK SKYHAWK</b>		2.0L L4 122 CID	1985	<b>CADILLAC DEVILLE</b>	4.3L V6 260 CID
	1983-1986	<b>CADILLAC CIMARRON</b>		2.0L L4 122 CID	1985	<b>CADILLAC FLEETWOOD</b>	4.3L V6 260 CID
	1983-1986	<b>CHEVROLET CAVALIER</b>		2.0L L4 122 CID	1985	<b>OLDSMOBILE 98</b>	4.3L V6 260 CID
	1983-1986	<b>OLDSMOBILE FIRENZA</b>		2.0L L4 122 CID	<b>US5015</b>	1983-1984	<b>CHEVROLET S10</b>
	1984-1985	<b>PONTIAC J2000 SUNBIRD</b>	2.0L L4 122 CID	1983-1984		<b>CHEVROLET S10 BLAZER</b>	2.0L L4 122 CID
1986	<b>PONTIAC SUNBIRD</b>	2.0L L4 122 CID	1983-1984	<b>GMC S15</b>		2.0L L4 122 CID	
1983-1984	<b>CHEVROLET C10</b>	6.2L V8 379 CID	1983-1984	<b>GMC S15 JIMMY</b>		2.0L L4 122 CID	
<b>US5008</b>	1982-1986	<b>CHEVROLET C10 SUBURBAN</b>	6.2L V8 379 CID	<b>US5016</b>	1984-1991	<b>CHEVROLET CORVETTE</b>	5.7L V8 350 CID
	1982-1986	<b>CHEVROLET C20</b>	6.2L V8 379 CID	<b>US5016H</b>	1984-1991	<b>CHEVROLET CORVETTE</b>	5.7L V8 350 CID
	1982-1986	<b>CHEVROLET C20 SUBURBAN</b>	6.2L V8 379 CID	<b>US5017</b>	1982-1986	<b>BUICK SKYHAWK</b>	1.8L L4 112 CID
	1982-1986	<b>CHEVROLET C30</b>	6.2L V8 379 CID	1982-1986	<b>OLDSMOBILE FIRENZA</b>	1.8L L4 112 CID	
	1982-1986	<b>CHEVROLET K5 BLAZER</b>	6.2L V8 379 CID	1985	<b>PONTIAC J2000 SUNBIRD</b>	1.8L L4 112 CID	
	1982-1986	<b>CHEVROLET K10</b>	6.2L V8 379 CID	1986	<b>PONTIAC SUNBIRD</b>	1.8L L4 112 CID	
	1982-1986	<b>CHEVROLET K10 SUBURBAN</b>	6.2L V8 379 CID	<b>US5019</b>	1966-1969	<b>CHEVROLET CORVETTE</b>	7.0L V8 6998cc 427 CID
	1982-1986	<b>CHEVROLET K20</b>	6.2L V8 379 CID		1968-1969	<b>CHEVROLET CORVETTE</b>	7.0L V8 427 CID
	1982-1986	<b>CHEVROLET K20 SUBURBAN</b>	6.2L V8 379 CID		<b>US5019H</b>	1966-1969	<b>CHEVROLET CORVETTE</b>
	1982-1986	<b>CHEVROLET K30</b>	6.2L V8 379 CID	1968-1969		<b>CHEVROLET CORVETTE</b>	7.0L V8 427 CID
	1982-1986	<b>GMC C1500</b>	6.2L V8 379 CID	<b>US5020</b>		1985-1986	<b>CADILLAC CIMARRON</b>
	1982-1986	<b>GMC C1500 SUBURBAN</b>	6.2L V8 379 CID		1985-1986	<b>CHEVROLET CAVALIER</b>	2.8L V6 173 CID
	1982-1986	<b>GMC C2500</b>	6.2L V8 379 CID		1985-1986	<b>OLDSMOBILE FIRENZA</b>	2.8L V6 173 CID
	1982-1986	<b>GMC C2500 SUBURBAN</b>	6.2L V8 379 CID	<b>US5022</b>	1985-1986	<b>CHEVROLET ASTRO</b>	2.5L L4 2474cc 151 CID
	1982-1986	<b>GMC C3500</b>	6.2L V8 379 CID		1985-1986	<b>CHEVROLET CAMARO</b>	2.5L L4 2474cc 151 CID
1982-1986	<b>GMC K1500 SUBURBAN</b>	6.2L V8 379 CID	1985-1986		<b>CHEVROLET S10</b>	2.5L L4 2474cc 151 CID	
1982-1986	<b>GMC K1500 SUBURBAN</b>	6.2L V8 379 CID	1985-1986		<b>CHEVROLET S10 BLAZER</b>	2.5L L4 2474cc 151 CID	
1982-1986	<b>GMC K2500</b>	6.2L V8 379 CID	1985-1986		<b>GMC S15</b>	2.5L L4 2474cc 151 CID	

WATER PUMPS



USMW	Years	Application	Engine	USMW	Years	Application	Engine
<b>US5022</b>	1985-1986	<b>GMC S15 JIMMY</b>	2.5L L4 2474cc 151 CID	<b>US5031</b>	1985-1988	<b>CHEVROLET SPECTRUM</b>	1.5L L4 1471cc 92 CID
	1985-1986	<b>GMC SAFARI</b>	2.5L L4 2474cc 151 CID		1985-1989	<b>ISUZU I-MARK</b>	1.5L L4 1471cc
	1985-1986	<b>PONTIAC FIREBIRD</b>	2.5L L4 2474cc 151 CID		1989	<b>GEO SPECTRUM</b>	1.5L L4 1471cc 92 CID
<b>US5023</b>	1985-1987	<b>CADILLAC COMMERCIAL CHASSIS</b>	4.1L V8 250 CID	<b>US5032</b>	1987-1988	<b>OLDSMOBILE FIRENZA</b>	2.0L L4 122 CID
	1985-1987	<b>CADILLAC DEVILLE</b>	4.1L V8 250 CID		1987-1989	<b>BUICK SKYHAWK</b>	2.0L L4 122 CID
	1985-1987	<b>CADILLAC FLEETWOOD</b>	4.1L V8 250 CID		1987-1989	<b>CHEVROLET BERETTA</b>	2.0L L4 122 CID
	1986-1987	<b>CADILLAC ELDORADO</b>	4.1L V8 250 CID		1987-1989	<b>CHEVROLET CAVALIER</b>	2.0L L4 122 CID
	1986-1987	<b>CADILLAC SEVILLE</b>	4.1L V8 250 CID		1987-1989	<b>CHEVROLET CORSICA</b>	2.0L L4 122 CID
	1987-1988	<b>CADILLAC ALLANTE</b>	4.1L V8 250 CID		1990-1991	<b>CHEVROLET BERETTA</b>	2.2L L4 134 CID
	1988-1990	<b>CADILLAC COMMERCIAL CHASSIS</b>	4.5L V8 273 CID		1990-1991	<b>CHEVROLET CAVALIER</b>	2.2L L4 134 CID
	1988-1990	<b>CADILLAC DEVILLE</b>	4.5L V8 273 CID		1990-1991	<b>CHEVROLET CORSICA</b>	2.2L L4 134 CID
	1988-1990	<b>CADILLAC ELDORADO</b>	4.5L V8 273 CID		1992-1996	<b>CHEVROLET BERETTA</b>	2.2L L4 2190cc 134 CID
	1988-1990	<b>CADILLAC FLEETWOOD</b>	4.5L V8 273 CID		1992-1996	<b>CHEVROLET CORSICA</b>	2.2L L4 2190cc 134 CID
	1988-1990	<b>CADILLAC SEVILLE</b>	4.5L V8 273 CID		1992-2002	<b>CHEVROLET CAVALIER</b>	2.2L L4 2190cc 134 CID
	1989-1992	<b>CADILLAC ALLANTE</b>	4.5L V8 273 CID		1993-1996	<b>BUICK CENTURY</b>	2.2L L4 2190cc 134 CID
	1991-1992	<b>CADILLAC FLEETWOOD</b>	4.9L V8 300 CID		1993-1996	<b>OLDSMOBILE CUTLASS CIERA</b>	2.2L L4 2190cc 134 CID
	1991-1993	<b>CADILLAC COMMERCIAL CHASSIS</b>	4.9L V8 300 CID		1994-1995	<b>CHEVROLET LLV</b>	2.2L L4 2190cc 134 CID
	1991-1993	<b>CADILLAC ELDORADO</b>	4.9L V8 300 CID		1994-2003	<b>CHEVROLET S10</b>	2.2L L4 2190cc 134 CID
	1991-1993	<b>CADILLAC SEVILLE</b>	4.9L V8 300 CID		1994-2003	<b>GMC SONOMA</b>	2.2L L4 2190cc 134 CID
	1991-1995	<b>CADILLAC DEVILLE</b>	4.9L V8 300 CID		1995-2002	<b>PONTIAC SUNFIRE</b>	2.2L L4 2190cc 134 CID
1993	<b>CADILLAC 60 SPECIAL</b>	4.9L V8 300 CID	1996-2000	<b>ISUZU HOMBRE</b>	2.2L L4 2190cc 134 CID		
<b>US5027</b>	1983-1984	<b>ISUZU I-MARK</b>	1.8L L4 1817cc	1997-1999	<b>CHEVROLET LUV</b>	2.2L L4 2190cc 133 CID	
	1985-1986	<b>CHEVROLET CHEVETTE</b>	1.8L L4 1819cc 110 CID	2001-2002	<b>CHEVROLET S10</b>	2.2L L4 2200cc 134 CID	
<b>US5028</b>	1982-1985	<b>BUICK CENTURY</b>	3.0L V6 181 CID	<b>US5033</b>	1982-1984	<b>CHEVROLET CELEBRITY</b>	2.8L V6 2835cc 173 CID
	1982-1985	<b>OLDSMOBILE CUTLASS CIERA</b>	3.0L V6 181 CID		1983-1986	<b>CHEVROLET CENTURY</b>	2.8L V6 2800cc 173 CID
	1984-1985	<b>BUICK CENTURY</b>	3.8L V6 3800cc 231 CID		1986-1989	<b>CHEVROLET CUTLASS</b>	2.8L V6 2835cc 173 CID
	1984-1985	<b>OLDSMOBILE CUTLASS CIERA</b>	3.8L V6 3800cc 231 CID		1986-1997	<b>CHEVROLET CUTLASS</b>	3.1L V6 3130cc 191 CID
	1985	<b>BUICK ELECTRA</b>	3.0L V6 181 CID		1987	<b>OLDSMOBILE FIRENZA</b>	2.8L V6 173 CID
	1985	<b>BUICK ELECTRA</b>	3.8L V6 3800cc 231 CID		1987-1988	<b>CADILLAC CIMARRON</b>	2.8L V6 173 CID
	1985	<b>OLDSMOBILE 98</b>	3.0L V6 181 CID		1987-1989	<b>BUICK CENTURY</b>	2.8L V6 173 CID
	1985	<b>OLDSMOBILE 98</b>	3.8L V6 3800cc 231 CID		1987-1989	<b>CHEVROLET BERETTA</b>	2.8L V6 173 CID
<b>US5029</b>	1985-1988	<b>CHEVROLET SPRINT</b>	1.0L L3 993cc 61 CID	1987-1989	<b>CHEVROLET CAVALIER</b>	2.8L V6 173 CID	
	1986-1989	<b>SUZUKI SAMURAI</b>	1.3L L4 1325cc 81 CID	1987-1989	<b>CHEVROLET CELEBRITY</b>	2.8L V6 173 CID	
	1989	<b>SUZUKI SIDEKICK</b>	1.3L L4 1325cc 81 CID	1987-1989	<b>CHEVROLET CORSICA</b>	2.8L V6 173 CID	
1990-1995	<b>SUZUKI SAMURAI</b>	1.3L L4 1298cc 79 CID	1987-1989	<b>OLDSMOBILE CUTLASS CIERA</b>	2.8L V6 173 CID		
	1987-1989	<b>OLDSMOBILE CUTLASS CRUISER</b>	2.8L V6 173 CID				
	1987-1989	<b>PONTIAC 6000</b>	2.8L V6 173 CID				
<b>US5030</b>	1975-1978	<b>GMC P15</b>	4.8L L6 292 CID	1988-1989	<b>BUICK REGAL</b>	2.8L V6 173 CID	
	1975-1980	<b>CHEVROLET P10</b>	4.8L L6 292 CID	1988-1989	<b>OLDSMOBILE CUTLASS SUPREME</b>	2.8L V6 173 CID	
	1977-1978	<b>GMC K35</b>	4.8L L6 292 CID	1988-1989	<b>PONTIAC GRAND PRIX</b>	2.8L V6 173 CID	
	1977-1986	<b>CHEVROLET K30</b>	4.8L L6 292 CID	1988-1991	<b>PONTIAC 6000</b>	3.1L V6 189 CID	
	1978	<b>CHEVROLET CS1073</b>	4.8L L6 4800cc 292 CID	1989-1996	<b>BUICK REGAL</b>	3.1L V6 189 CID	
	1978	<b>CHEVROLET CS31003</b>	4.8L L6 4800cc 292 CID	1989-1997	<b>CHEVROLET CENTURY</b>	3.1L V6 3130cc 191 CID	
	1978	<b>CHEVROLET G20</b>	4.8L L6 292 CID	1989-1997	<b>OLDSMOBILE CUTLASS SUPREME</b>	3.1L V6 189 CID	
	1978	<b>CHEVROLET G30</b>	4.8L L6 292 CID	1989-2003	<b>PONTIAC GRAND PRIX</b>	3.1L V6 189 CID	
	1978	<b>GMC C25</b>	4.8L L6 292 CID	1990	<b>CHEVROLET CELEBRITY</b>	2.8L V6 2800cc 173 CID	
	1978	<b>GMC C25 SUBURBAN</b>	4.8L L6 292 CID	1990	<b>CHEVROLET CELEBRITY</b>	3.1L V6 189 CID	
	1978	<b>GMC G25</b>	4.8L L6 292 CID	1990	<b>CHEVROLET CENTURY</b>	2.8L V6 2800cc 173 CID	
	1978	<b>GMC G35</b>	4.8L L6 292 CID	1990-1994	<b>CHEVROLET CAVALIER</b>	2.8L V6 2800cc 173 CID	
	1978	<b>GMC K25</b>	4.8L L6 292 CID	1990-1994	<b>CHEVROLET CAVALIER</b>	3.1L V6 189 CID	
	1978	<b>GMC K25 SUBURBAN</b>	4.8L L6 292 CID	1990-1994	<b>CHEVROLET S10 BLAZER</b>	3.1L V6 3100cc 191 CID	
	1978	<b>GMC P25</b>	4.8L L6 292 CID	1990-1994	<b>OLDSMOBILE SILHOUETTE</b>	3.1L V6 189 CID	
	1978	<b>GMC P35</b>	4.8L L6 292 CID	1990-1995	<b>CHEVROLET LUMINA APV</b>	3.1L V6 189 CID	
	1978-1982	<b>CHEVROLET C20 SUBURBAN</b>	4.8L L6 292 CID	1990-1995	<b>PONTIAC TRANS SPORT</b>	3.1L V6 189 CID	
	1978-1982	<b>CHEVROLET K20 SUBURBAN</b>	4.8L L6 292 CID	1990-1996	<b>CHEVROLET BERETTA</b>	3.1L V6 189 CID	
	1978-1986	<b>CHEVROLET C20</b>	4.8L L6 292 CID	1990-1996	<b>CHEVROLET CORSICA</b>	3.1L V6 189 CID	
	1978-1986	<b>CHEVROLET C30</b>	4.8L L6 292 CID	1990-2001	<b>CHEVROLET LUMINA</b>	3.1L V6 189 CID	
	1978-1986	<b>CHEVROLET K20</b>	4.8L L6 292 CID	1991-1994	<b>PONTIAC SUNBIRD</b>	3.1L V6 189 CID	
	1978-1989	<b>CHEVROLET P20</b>	4.8L L6 292 CID	1991-1996	<b>CHEVROLET EUROSPOUR</b>	3.1L V6 3135cc 191 CID	
	1978-1989	<b>CHEVROLET P30</b>	4.8L L6 292 CID	1991-1996	<b>OLDSMOBILE CUTLASS SUPREME</b>	3.4L V6 207 CID	
	1979-1980	<b>GMC P1500</b>	4.8L L6 292 CID	1991-1996	<b>PONTIAC GRAND PRIX</b>	3.4L V6 207 CID	
	1979-1982	<b>GMC C2500 SUBURBAN</b>	4.8L L6 292 CID	1991-1997	<b>CHEVROLET LUMINA</b>	3.4L V6 207 CID	
	1979-1982	<b>GMC K2500 SUBURBAN</b>	4.8L L6 292 CID	1994	<b>OLDSMOBILE CUTLASS CRUISER</b>	3.1L V6 189 CID	
	1979-1986	<b>GMC C2500</b>	4.8L L6 292 CID	1994-1996	<b>CHEVROLET CUTLASS</b>	2.2L L4 2196cc 134 CID	
	1979-1986	<b>GMC K2500</b>	4.8L L6 292 CID	1994-1996	<b>OLDSMOBILE CUTLASS CIERA</b>	3.1L V6 189 CID	
	1979-1986	<b>GMC K3500</b>	4.8L L6 292 CID	1994-1998	<b>BUICK SKYLARK</b>	3.1L V6 189 CID	
	1979-1987	<b>GMC P2500</b>	4.8L L6 292 CID	1994-1998	<b>OLDSMOBILE ACHIEVA</b>	3.1L V6 189 CID	
	1979-1989	<b>GMC P3500</b>	4.8L L6 292 CID	1994-1998	<b>PONTIAC GRAND AM</b>	3.1L V6 189 CID	
	1980	<b>CHEVROLET C10</b>	4.8L L6 292 CID	1994-2005	<b>BUICK CENTURY</b>	3.1L V6 189 CID	
	1980	<b>CHEVROLET G20</b>	4.8L L6 292 CID	1995	<b>CHEVROLET CENTURY</b>	2.2L L4 2196cc 134 CID	
	1980	<b>CHEVROLET K10</b>	4.8L L6 292 CID	1995-1997	<b>CHEVROLET MONTE CARLO</b>	3.4L V6 207 CID	
	1980	<b>GMC C1500</b>	4.8L L6 292 CID	1995-1999	<b>CHEVROLET MONTE CARLO</b>	3.1L V6 189 CID	
	1980	<b>GMC K1500</b>	4.8L L6 292 CID	1996	<b>CHEVROLET LUMINA APV</b>	3.4L V6 207 CID	
	1980-1986	<b>GMC C3500</b>	4.8L L6 292 CID	1996-1998	<b>PONTIAC TRANS SPORT</b>	3.4L V6 207 CID	
	1981-1982	<b>CHEVROLET C10</b>	4.8L L6 4800cc 292 CID	1996-2004	<b>OLDSMOBILE SILHOUETTE</b>	3.4L V6 207 CID	
	1981-1986	<b>GMC C1500</b>	4.8L L6 4800cc 292 CID	1997	<b>CHEVROLET LUMINA</b>	3.3L V6 3343cc 204 CID	
	1984	<b>GMC C2500 SUBURBAN</b>	4.8L L6 292 CID	1997-1999	<b>OLDSMOBILE CUTLASS</b>	3.1L V6 189 CID	
	1984	<b>GMC K2500 SUBURBAN</b>	4.8L L6 292 CID	1997-2003	<b>CHEVROLET MALIBU</b>	3.1L V6 189 CID	
	1984-1986	<b>CHEVROLET C10</b>	4.8L L6 4800cc 292 CID	1997-2005	<b>CHEVROLET VENTURE</b>	3.4L V6 207 CID	
	1987	<b>CHEVROLET C35</b>	4.8L L6 4800cc 292 CID	1999-2004	<b>OLDSMOBILE ALERO</b>	3.4L V6 207 CID	
	1987	<b>CHEVROLET V20</b>	4.8L L6 292 CID	1999-2005	<b>PONTIAC GRAND AM</b>	3.4L V6 207 CID	
	1987	<b>GMC V2500</b>	4.8L L6 292 CID	1999-2005	<b>PONTIAC MONTANA</b>	3.4L V6 207 CID	
	1987-1988	<b>CHEVROLET R20</b>	4.8L L6 292 CID	2000-2005	<b>CHEVROLET IMPALA</b>	3.4L V6 207 CID	
	1987-1988	<b>CHEVROLET R30</b>	4.8L L6 292 CID	2000-2005	<b>CHEVROLET MONTE CARLO</b>	3.4L V6 207 CID	
1987-1988	<b>CHEVROLET V30</b>	4.8L L6 292 CID	2001-2005	<b>PONTIAC AZTEK</b>	3.4L V6 207 CID		
1987-1988	<b>GMC R2500</b>	4.8L L6 292 CID	2002-2005	<b>BUICK RENDEZVOUS</b>	3.4L V6 207 CID		
1987-1988	<b>GMC R3500</b>	4.8L L6 292 CID	2004-2006	<b>CHEVROLET MALIBU</b>	3.5L V6 213 CID		
1987-1988	<b>GMC V3500</b>	4.8L L6 292 CID	2005	<b>PONTIAC G6</b>	3.5L V6 211 CID		
1989	<b>GMC P2500</b>	4.8L L6 292 CID	2005-2006	<b>BUICK TERRAZA</b>	3.5L V6 213 CID		
1998	<b>CHEVROLET C1500</b>	4.1L L6 4100cc 250 CID					
1998-2002	<b>CHEVROLET P30 VAN</b>	4.1L L6 4100cc 250 CID					

USMW	Years	Application	Engine	USMW	Years	Application	Engine
<b>US5033</b>	2005-2006	CHEVROLET UPLANDER	3.5L V6 213 CID	<b>US5043</b>	1995	PONTIAC SUNFIRE	2.3L L4 138 CID
	2005-2006	PONTIAC MONTANA	3.5L V6 213 CID	<b>US5045</b>	1988-1990	PONTIAC LEMANS	1.6L L4 1588cc 98 CID
	2005-2006	SATURN RELAY	3.5L V6 213 CID	<b>US5048</b>	1989-1997	GEO TRACKER	1.6L L4 1588cc 98 CID
	2006	PONTIAC G6	3.5L V6 214 CID		1989-1998	SUZUKI SIDEKICK	1.6L L4 1590cc 97 CID
	2006-2007	BUICK RENDEZVOUS	3.5L V6 213 CID		1995-1996	SUZUKI ESTEEM	1.6L L4 1590cc 97 CID
<b>US5035</b>	1987-1989	CHEVROLET S10 BLAZER	2.8L V6 173 CID		1996-1998	SUZUKI X-90	1.6L L4 1590cc 97 CID
	1987-1989	GMC S15 JIMMY	2.8L V6 173 CID		1998	CHEVROLET TRACKER	1.6L L4 1588cc 98 CID
	1987-1990	GMC S15	2.8L V6 173 CID	1999-2001	CHEVROLET TRACKER	2.2L L4 2196cc 134 CID	
	1987-1993	CHEVROLET S10	2.8L V6 173 CID	2005	CHEVROLET TRACKER	2.2L L4 2190cc 134 CID	
	1989-1991	ISUZU TROOPER	2.8L V6 2827cc	<b>US5049</b>	1987-1988	CHEVROLET R10 SUBURBAN	5.7L V8 350 CID
	1991-1992	ISUZU RODEO	3.1L V6 3137cc		1987-1988	CHEVROLET R20 SUBURBAN	5.7L V8 350 CID
	1991-1993	GMC SONOMA	2.8L V6 173 CID		1987-1988	CHEVROLET V10 SUBURBAN	5.7L V8 350 CID
1991-1994	ISUZU PICKUP	3.1L V6 3137cc	1987-1993		CHEVROLET G10	5.7L V8 350 CID	
<b>US5036</b>	1982-1983	PONTIAC J2000	1.8L L4 112 CID		1987-1993	GMC G1500	5.7L V8 350 CID
	1984	PONTIAC J2000 SUNBIRD	1.8L L4 112 CID		1987-1995	CHEVROLET ASTRO	4.3L V6 262 CID
	1987-1988	BUICK SKYHAWK	2.0L L4 122 CID		1987-1995	CHEVROLET G10	4.3L V6 262 CID
	1987-1988	OLDSMOBILE FIRENZA	2.0L L4 122 CID		1987-1995	CHEVROLET G10	5.0L V8 305 CID
	1987-1989	PONTIAC GRAND AM	2.0L L4 122 CID		1987-1995	CHEVROLET G20	4.3L V6 262 CID
	1987-1994	PONTIAC SUNBIRD	2.0L L4 122 CID		1987-1995	CHEVROLET G20	5.0L V8 305 CID
	1989-1990	PONTIAC LEMANS	2.0L L4 122 CID		1987-1995	CHEVROLET G20	5.7L V8 350 CID
	1987-1989	CHEVROLET CAMARO	2.8L V6 173 CID		1987-1995	GMC G1500	4.3L V6 262 CID
	1987-1989	PONTIAC FIREBIRD	2.8L V6 173 CID		1987-1995	GMC G1500	5.0L V8 305 CID
	1990-1992	CHEVROLET CAMARO	3.1L V6 189 CID		1987-1995	GMC G2500	4.3L V6 262 CID
<b>US5037</b>	1990-1992	PONTIAC FIREBIRD	3.1L V6 189 CID		1987-1995	GMC G2500	5.0L V8 305 CID
	1992-1999	CHEVROLET G30	7.4L V8 454 CID	1987-1995	GMC G2500	5.7L V8 350 CID	
<b>US5038</b>	1988-1996	GMC G3500	7.4L V8 454 CID	1987-1995	GMC G3500	4.3L V6 262 CID	
	1988-2000	CHEVROLET C3500	7.4L V8 454 CID	1987-1995	GMC SAFARI	4.3L V6 262 CID	
	1988-2000	CHEVROLET K3500	7.4L V8 454 CID	1987-1996	CHEVROLET G30	4.3L V6 262 CID	
	1988-2000	GMC C3500	7.4L V8 454 CID	1987-1996	CHEVROLET G30	5.7L V8 350 CID	
	1988-2000	GMC K3500	7.4L V8 454 CID	1987-1996	GMC G3500	5.7L V8 350 CID	
	1989-1991	CHEVROLET R2500 SUBURBAN	7.4L V8 454 CID	1988	CHEVROLET V20 SUBURBAN	5.7L V8 350 CID	
	1989-1991	GMC R2500 SUBURBAN	7.4L V8 454 CID	1988-1990	GMC S15	4.3L V6 262 CID	
	1990-1993	CHEVROLET C1500	7.4L V8 454 CID	1988-1991	CHEVROLET C1500	5.7L V8 5700cc 350 CID	
	1991-2000	CHEVROLET C2500	7.4L V8 454 CID	1988-1991	CHEVROLET C2500	5.7L V8 5700cc 350 CID	
	1991-2000	CHEVROLET K2500	7.4L V8 454 CID	1988-1991	GMC S15 JIMMY	4.3L V6 262 CID	
	1991-2000	GMC C2500	7.4L V8 454 CID	1988-1992	CHEVROLET CAMARO	5.0L V8 305 CID	
	1991-2000	GMC K2500	7.4L V8 454 CID	1988-1992	CHEVROLET CAMARO	5.7L V8 305 CID	
	1992-1999	CHEVROLET C2500 SUBURBAN	7.4L V8 454 CID	1988-1992	PONTIAC FIREBIRD	5.0L V8 305 CID	
	1992-1999	CHEVROLET K2500 SUBURBAN	7.4L V8 454 CID	1988-1992	PONTIAC FIREBIRD	5.7L V8 350 CID	
	1992-1999	GMC C2500 SUBURBAN	7.4L V8 454 CID	1988-1994	CHEVROLET C3500	5.7L V8 5700cc 350 CID	
	1992-1999	GMC K2500 SUBURBAN	7.4L V8 454 CID	1988-1994	CHEVROLET S10 BLAZER	4.3L V6 262 CID	
	1996-2000	CHEVROLET EXPRESS 3500	7.4L V8 454 CID	1988-1995	CHEVROLET C1500	4.3L V6 262 CID	
	1996-2000	GMC SAVANA 3500	7.4L V8 454 CID	1988-1995	CHEVROLET C1500	5.0L V8 305 CID	
	<b>US5038H</b>	1988-1996	CHEVROLET G30	7.4L V8 454 CID	1988-1995	CHEVROLET C1500	5.7L V8 350 CID
		1988-1996	GMC G3500	7.4L V8 454 CID	1988-1995	CHEVROLET C2500	4.3L V6 262 CID
		1988-2000	CHEVROLET C3500	7.4L V8 454 CID	1988-1995	CHEVROLET C2500	5.0L V8 305 CID
		1988-2000	CHEVROLET K3500	7.4L V8 454 CID	1988-1995	CHEVROLET C2500	5.7L V8 350 CID
		1988-2000	GMC C3500	7.4L V8 454 CID	1988-1995	CHEVROLET C3500	5.7L V8 350 CID
		1988-2000	GMC K3500	7.4L V8 454 CID	1988-1995	CHEVROLET K1500	4.3L V6 262 CID
		1989-1991	CHEVROLET R2500 SUBURBAN	7.4L V8 454 CID	1988-1995	CHEVROLET K1500	5.0L V8 305 CID
1989-1991		GMC R2500 SUBURBAN	7.4L V8 454 CID	1988-1995	CHEVROLET K1500	5.7L V8 350 CID	
1990-1993		CHEVROLET C1500	7.4L V8 454 CID	1988-1995	CHEVROLET K2500	4.3L V6 262 CID	
1991-2000		CHEVROLET C2500	7.4L V8 454 CID	1988-1995	CHEVROLET K2500	5.0L V8 305 CID	
1991-2000		CHEVROLET K2500	7.4L V8 454 CID	1988-1995	CHEVROLET K2500	5.7L V8 350 CID	
1991-2000		GMC C2500	7.4L V8 454 CID	1988-1995	CHEVROLET K3500	5.7L V8 350 CID	
1991-2000		GMC K2500	7.4L V8 454 CID	1988-1995	CHEVROLET S10	4.3L V6 262 CID	
1992-1999		CHEVROLET C2500 SUBURBAN	7.4L V8 454 CID	1988-1995	GMC C1500	4.3L V6 262 CID	
1992-1999		CHEVROLET K2500 SUBURBAN	7.4L V8 454 CID	1988-1995	GMC C1500	5.0L V8 305 CID	
1992-1999		GMC C2500 SUBURBAN	7.4L V8 454 CID	1988-1995	GMC C1500	5.7L V8 350 CID	
1992-1999		GMC K2500 SUBURBAN	7.4L V8 454 CID	1988-1995	GMC C2500	4.3L V6 262 CID	
1996-2000		CHEVROLET EXPRESS 3500	7.4L V8 454 CID	1988-1995	GMC C2500	5.0L V8 305 CID	
1996-2000		GMC SAVANA 3500	7.4L V8 454 CID	1988-1995	GMC C2500	5.7L V8 350 CID	
<b>US5040</b>		1987-1988	CHEVROLET S10 BLAZER	2.5L L4 2474cc 151 CID	1988-1995	GMC C3500	5.7L V8 350 CID
		1987-1988	GMC S15 JIMMY	2.5L L4 2474cc 151 CID	1988-1995	GMC K1500	4.3L V6 262 CID
		1987-1990	CHEVROLET ASTRO	2.5L L4 2474cc 151 CID	1988-1995	GMC K1500	5.0L V8 305 CID
		1987-1990	GMC S15	2.5L L4 2474cc 151 CID	1988-1995	GMC K1500	5.7L V8 350 CID
		1987-1990	GMC SAFARI	2.5L L4 2474cc 151 CID	1988-1995	GMC K2500	4.3L V6 262 CID
		1987-1993	CHEVROLET LLV	2.5L L4 2474cc 151 CID	1988-1995	GMC K2500	5.0L V8 305 CID
	1987-1993	CHEVROLET S10	2.5L L4 2474cc 151 CID	1988-1995	GMC K2500	5.7L V8 350 CID	
	1991-1993	GMC SONOMA	2.5L L4 2474cc 151 CID	1988-1995	GMC K3500	5.7L V8 350 CID	
	<b>US5041</b>	1987-1990	CHEVROLET CELEBRITY	2.5L L4 2474cc 151 CID	1989-1990	CHEVROLET CAPRICE	4.3L V6 262 CID
		1987-1990	OLDSMOBILE CUTLASS CRUISER	2.5L L4 2474cc 151 CID	1989-1990	CHEVROLET CAPRICE	5.0L V8 305 CID
		1987-1991	PONTIAC 6000	2.5L L4 2474cc 151 CID	1989-1990	CHEVROLET CAPRICE	5.7L V8 350 CID
		1987-1992	BUICK CENTURY	2.5L L4 2474cc 151 CID	1989-1990	GMC C1500	5.7L V8 5700cc 350 CID
		1987-1992	OLDSMOBILE CUTLASS CIERA	2.5L L4 2474cc 151 CID	1989-1991	CHEVROLET P30 VAN	5.7L V8 5700cc 350 CID
		1990-1992	CHEVROLET LUMINA	2.5L L4 2474cc 151 CID	1989-1991	CHEVROLET R1500 SUBURBAN	5.7L V8 350 CID
		1989-1991	CHEVROLET R2500 SUBURBAN	5.7L V8 350 CID	1989-1991	CHEVROLET R2500 SUBURBAN	5.7L V8 350 CID
<b>US5043</b>	1987	OLDSMOBILE CALAIS	2.3L L4 138 CID	1989-1991	CHEVROLET V1500 SUBURBAN	5.7L V8 350 CID	
	1988-1991	OLDSMOBILE CUTLASS CALAIS	2.3L L4 138 CID	1989-1991	CHEVROLET V2500 SUBURBAN	5.7L V8 350 CID	
	1988-1995	BUICK SKYLARK	2.3L L4 138 CID	1989-1991	GMC C2500	5.7L V8 5700cc 350 CID	
	1988-1995	PONTIAC GRAND AM	2.3L L4 138 CID	1989-1991	GMC C3500	5.7L V8 5700cc 350 CID	
	1989-1991	OLDSMOBILE CUTLASS CALAIS	2.3L L4 140 CID	1989-1991	GMC JIMMY	5.7L V8 350 CID	
	1989-1994	PONTIAC GRAND AM	2.3L L4 140 CID	1989-1991	GMC P3500	5.7L V8 5700cc 350 CID	
	1990	OLDSMOBILE CUTLASS SUPREME	2.3L L4 140 CID	1989-1991	GMC R1500 SUBURBAN	5.7L V8 350 CID	
	1990-1991	OLDSMOBILE CUTLASS SUPREME	2.3L L4 138 CID	1989-1991	GMC R2500 SUBURBAN	5.7L V8 350 CID	
	1990-1991	PONTIAC GRAND PRIX	2.3L L4 138 CID	1989-1991	GMC V1500 SUBURBAN	5.7L V8 350 CID	
	1990-1994	CHEVROLET BERETTA	2.3L L4 140 CID	1989-1991	GMC V2500 SUBURBAN	5.7L V8 350 CID	
	1992-1994	OLDSMOBILE ACHIEVA	2.3L L4 140 CID	1989-1994	CHEVROLET BLAZER	5.7L V8 350 CID	
	1992-1995	OLDSMOBILE ACHIEVA	2.3L L4 138 CID	1990-1991	GMC MICROBUS	5.7L V8 5700cc 350 CID	
	1995	CHEVROLET CAVALIER	2.3L L4 138 CID				

WATER PUMPS

USMW	Years	Application	Engine	USMW	Years	Application	Engine		
<b>US5049</b>	1990-1992	CADILLAC BROUGHAM	5.7L V8 350 CID	<b>US5049H</b>	1989-1991	CHEVROLET R2500 SUBURBAN	5.7L V8 350 CID		
	1990-1996	CHEVROLET MICROBUS	5.7L V8 5700cc 350 CID		1989-1991	CHEVROLET V1500 SUBURBAN	5.7L V8 350 CID		
	1991	GMC SYCLONE	4.3L V6 262 CID		1989-1991	CHEVROLET V2500 SUBURBAN	5.7L V8 350 CID		
	1991-1992	CADILLAC BROUGHAM	5.0L V8 305 CID		1989-1991	GMC JIMMY	5.7L V8 350 CID		
	1991-1994	OLDSMOBILE BRAVADA	4.3L V6 262 CID		1989-1991	GMC R1500 SUBURBAN	5.7L V8 350 CID		
	1991-1995	GMC SONOMA	4.3L V6 262 CID		1989-1991	GMC R2500 SUBURBAN	5.7L V8 350 CID		
	1992-1993	CADILLAC COMMERCIAL CHASSIS	5.7L V8 350 CID		1989-1991	GMC V1500 SUBURBAN	5.7L V8 350 CID		
	1992-1993	CHEVROLET CAPRICE	4.3L V6 262 CID		1989-1991	GMC V2500 SUBURBAN	5.7L V8 350 CID		
	1992-1993	GMC TYPHOON	4.3L V6 262 CID		1989-1994	CHEVROLET BLAZER	5.7L V8 350 CID		
	1992-1995	CHEVROLET C25	5.7L V8 5700cc 350 CID		1990-1992	CADILLAC BROUGHAM	5.7L V8 350 CID		
	1992-1995	CHEVROLET C1500 SUBURBAN	5.7L V8 350 CID		1991	GMC SYCLONE	4.3L V6 262 CID		
	1992-1995	CHEVROLET C2500 SUBURBAN	5.7L V8 350 CID		1991-1992	CADILLAC BROUGHAM	5.0L V8 305 CID		
	1992-1995	CHEVROLET K1500 SUBURBAN	5.7L V8 350 CID		1991-1994	OLDSMOBILE BRAVADA	4.3L V6 262 CID		
	1992-1995	CHEVROLET K2500 SUBURBAN	5.7L V8 350 CID		1991-1995	GMC SONOMA	4.3L V6 262 CID		
	1992-1995	GMC C1500 SUBURBAN	5.7L V8 350 CID		1992-1993	CADILLAC COMMERCIAL CHASSIS	5.7L V8 350 CID		
	1992-1995	GMC C2500 SUBURBAN	5.7L V8 350 CID		1992-1993	CHEVROLET CAPRICE	4.3L V6 262 CID		
	1992-1995	GMC JIMMY	4.3L V6 262 CID		1992-1993	GMC TYPHOON	4.3L V6 262 CID		
	1992-1995	GMC K1500 SUBURBAN	5.7L V8 350 CID		1992-1995	CHEVROLET C1500 SUBURBAN	5.7L V8 350 CID		
	1992-1995	GMC K2500 SUBURBAN	5.7L V8 350 CID		1992-1995	CHEVROLET C2500 SUBURBAN	5.7L V8 350 CID		
	1992-1995	GMC YUKON	5.7L V8 350 CID		1992-1995	CHEVROLET K1500 SUBURBAN	5.7L V8 350 CID		
	1993	CADILLAC FLEETWOOD	5.7L V8 350 CID		1992-1995	CHEVROLET K2500 SUBURBAN	5.7L V8 350 CID		
	1995	CHEVROLET BLAZER	4.3L V6 262 CID		1992-1995	GMC C1500 SUBURBAN	5.7L V8 350 CID		
	1995	CHEVROLET SILVERADO	5.7L V8 5700cc 350 CID		1992-1995	GMC C2500 SUBURBAN	5.7L V8 350 CID		
	1995	CHEVROLET TAHOE	5.7L V8 350 CID		1992-1995	GMC JIMMY	4.3L V6 262 CID		
	1995-1996	AM GENERAL HUMMER	5.7L V8 350 CID		1992-1995	GMC K1500 SUBURBAN	5.7L V8 350 CID		
	1996	CHEVROLET P31 VAN	5.7L V8 5737cc 350 CID		1992-1995	GMC K2500 SUBURBAN	5.7L V8 350 CID		
	2000-2002	CHEVROLET SONORA	5.7L V8 5737cc 350 CID		1992-1995	GMC YUKON	5.7L V8 350 CID		
	<b>US5049H</b>	1987-1988	CHEVROLET R10 SUBURBAN		5.7L V8 350 CID	1993	CADILLAC FLEETWOOD	5.7L V8 350 CID	
		1987-1988	CHEVROLET R20 SUBURBAN		5.7L V8 350 CID	1995	CHEVROLET BLAZER	4.3L V6 262 CID	
		1987-1988	CHEVROLET V10 SUBURBAN		5.7L V8 350 CID	1995	CHEVROLET TAHOE	5.7L V8 350 CID	
		1987-1993	CHEVROLET G10		5.7L V8 350 CID	1995-1996	AM GENERAL HUMMER	5.7L V8 350 CID	
		1987-1993	GMC G1500		5.7L V8 350 CID	<b>US5050</b>	1985	BUICK SOMERSET REGAL	3.0L V6 181 CID
		1987-1995	CHEVROLET ASTRO		4.3L V6 262 CID		1985-1987	OLDSMOBILE CALAIS	3.0L V6 181 CID
		1987-1995	CHEVROLET G10		4.3L V6 262 CID		1985-1987	PONTIAC GRAND AM	3.0L V6 181 CID
		1987-1995	CHEVROLET G10		5.0L V8 305 CID		1986	BUICK LESABRE	3.0L V6 181 CID
		1987-1995	CHEVROLET G20		4.3L V6 262 CID		1986	OLDSMOBILE DELTA 88	3.0L V6 181 CID
		1987-1995	CHEVROLET G20		5.0L V8 305 CID		1986-1987	BUICK SOMERSET	3.0L V6 181 CID
		1987-1995	CHEVROLET G20		5.7L V8 350 CID		1986-1988	BUICK CENTURY	3.8L V6 3800cc 231 CID
		1987-1995	GMC G1500		4.3L V6 262 CID		1986-1988	BUICK SKYLARK	3.0L V6 181 CID
		1987-1995	GMC G1500		5.0L V8 305 CID		1986-1988	OLDSMOBILE CUTLASS CIERA	3.8L V6 3800cc 231 CID
1987-1995		GMC G2500	4.3L V6 262 CID	1986-1990	BUICK ELECTRA		3.8L V6 3800cc 231 CID		
1987-1995		GMC G2500	5.0L V8 305 CID	1986-1991	OLDSMOBILE DELTA 88		3.8L V6 3800cc 231 CID		
1987-1995		GMC G2500	5.7L V8 350 CID	1986-1992	OLDSMOBILE TORONADO		3.8L V6 3800cc 231 CID		
1987-1995		GMC G3500	4.3L V6 262 CID	1986-1993	BUICK RIVIERA		3.8L V6 3800cc 231 CID		
1987-1995		GMC SAFARI	4.3L V6 262 CID	1986-1995	BUICK LESABRE		3.8L V6 3800cc 231 CID		
1987-1996		CHEVROLET G30	4.3L V6 262 CID	1986-1995	OLDSMOBILE 98		3.8L V6 3800cc 231 CID		
1987-1996		CHEVROLET G30	5.7L V8 350 CID	1987-1988	OLDSMOBILE CUTLASS CRUISER		3.8L V6 3800cc 231 CID		
1987-1996		GMC G3500	5.7L V8 350 CID	1987-1995	PONTIAC BONNEVILLE		3.8L V6 3800cc 231 CID		
1988		CHEVROLET V20 SUBURBAN	5.7L V8 350 CID	1988	OLDSMOBILE CUTLASS CALAIS		3.0L V6 181 CID		
1988-1990		GMC S15	4.3L V6 262 CID	1988-1991	BUICK REATTA		3.8L V6 3800cc 231 CID		
1988-1991		GMC S15 JIMMY	4.3L V6 262 CID	1989-1991	OLDSMOBILE CUTLASS CALAIS		3.3L V6 204 CID		
1988-1992		CHEVROLET CAMARO	5.0L V8 305 CID	1989-1993	BUICK CENTURY		3.3L V6 204 CID		
1988-1992		CHEVROLET CAMARO	5.7L V8 350 CID	1989-1993	BUICK SKYLARK		3.3L V6 204 CID		
1988-1992		PONTIAC FIREBIRD	5.0L V8 305 CID	1989-1993	OLDSMOBILE CUTLASS CIERA		3.3L V6 204 CID		
1988-1992		PONTIAC FIREBIRD	5.7L V8 350 CID	1989-1993	OLDSMOBILE CUTLASS CRUISER		3.3L V6 204 CID		
1988-1994		CHEVROLET S10 BLAZER	4.3L V6 262 CID	1990-1995	BUICK REGAL		3.8L V6 3800cc 231 CID		
1988-1995		CHEVROLET C1500	4.3L V6 262 CID	1991-1995	BUICK PARK AVENUE		3.8L V6 3800cc 231 CID		
1988-1995		CHEVROLET C1500	5.0L V8 305 CID	1992-1993	OLDSMOBILE ACHIEVA		3.3L V6 204 CID		
1988-1995		CHEVROLET C1500	5.7L V8 350 CID	1992-1993	PONTIAC GRAND AM		3.3L V6 204 CID		
1988-1995		CHEVROLET C2500	4.3L V6 262 CID	1992-1995	CHEVROLET LUMINA APV		3.8L V6 3800cc 231 CID		
1988-1995		CHEVROLET C2500	5.0L V8 305 CID	1992-1995	OLDSMOBILE 88		3.8L V6 3800cc 231 CID		
1988-1995		CHEVROLET C2500	5.7L V8 350 CID	1992-1995	OLDSMOBILE SILHOUETTE		3.8L V6 3800cc 231 CID		
1988-1995		CHEVROLET C3500	5.7L V8 350 CID	1992-1995	PONTIAC TRANS SPORT		3.8L V6 3800cc 231 CID		
1988-1995		CHEVROLET K1500	4.3L V6 262 CID	1995	BUICK RIVIERA		3.8L V6 3800cc 231 CID		
1988-1995		CHEVROLET K1500	5.0L V8 305 CID	1995	CHEVROLET CAMARO		3.8L V6 3800cc 231 CID		
1988-1995		CHEVROLET K1500	5.7L V8 350 CID	1995	PONTIAC FIREBIRD		3.8L V6 3800cc 231 CID		
1988-1995		CHEVROLET K2500	4.3L V6 262 CID	<b>US5051</b>	1991		BUICK COMMERCIAL CHASSIS	5.0L V8 305 CID	
1988-1995	CHEVROLET K2500	5.0L V8 305 CID	1991		BUICK ROADMASTER		5.0L V8 305 CID		
1988-1995	CHEVROLET K2500	5.7L V8 350 CID	1991-1992		OLDSMOBILE CUSTOM CRUISER		5.0L V8 305 CID		
1988-1995	CHEVROLET K3500	5.7L V8 350 CID	1991-1993		CHEVROLET CAPRICE		5.0L V8 305 CID		
1988-1995	CHEVROLET S10	4.3L V6 262 CID	1991-1993		CHEVROLET CAPRICE		5.7L V8 350 CID		
1988-1995	GMC C1500	4.3L V6 262 CID	1992		OLDSMOBILE CUSTOM CRUISER	5.7L V8 350 CID			
1988-1995	GMC C1500	5.0L V8 305 CID	1992-1993		BUICK COMMERCIAL CHASSIS	5.7L V8 350 CID			
1988-1995	GMC C1500	5.7L V8 350 CID	1992-1993		BUICK ROADMASTER	5.7L V8 350 CID			
1988-1995	GMC C2500	4.3L V6 262 CID	<b>US5054</b>		1991-1992	SATURN SC	1.9L L4 116 CID		
1988-1995	GMC C2500	5.0L V8 305 CID			1991-2002	SATURN SL	1.9L L4 116 CID		
1988-1995	GMC C2500	5.7L V8 350 CID			1991-2002	SATURN SL1	1.9L L4 116 CID		
1988-1995	GMC C3500	5.7L V8 350 CID			1991-2002	SATURN SL2	1.9L L4 116 CID		
1988-1995	GMC K1500	4.3L V6 262 CID			1993-1999	SATURN SW1	1.9L L4 116 CID		
1988-1995	GMC K1500	5.0L V8 305 CID			1993-2001	SATURN SW2	1.9L L4 116 CID		
1988-1995	GMC K1500	5.7L V8 350 CID			1993-2002	SATURN SC1	1.9L L4 116 CID		
1988-1995	GMC K2500	4.3L V6 262 CID			1993-2002	SATURN SC2	1.9L L4 116 CID		
1988-1995	GMC K2500	5.0L V8 305 CID			<b>US5056</b>	1990-1995	CHEVROLET CORVETTE	5.7L V8 350 CID	
1988-1995	GMC K2500	5.7L V8 350 CID				<b>US5057</b>	1991-1993	PONTIAC LEMANS	1.6L L4 1588cc 98 CID
1988-1995	GMC K3500	5.7L V8 350 CID	1994-1995				CHEVROLET JOY	1.4L L4 1400cc 85 CID	
1989-1990	CHEVROLET CAPRICE	4.3L V6 262 CID	1994-1995				CHEVROLET SWING	1.4L L4 1400cc 85 CID	
1989-1990	CHEVROLET CAPRICE	5.0L V8 305 CID	1996-2001				CHEVROLET POP	1.4L L4 1400cc 85 CID	
1989-1990	CHEVROLET CAPRICE	5.7L V8 350 CID	1996-2003				CHEVROLET JOY	1.6L L4 1600cc 98 CID	
1989-1991	CHEVROLET R1500 SUBURBAN	5.7L V8 350 CID	1996-2003		CHEVROLET SWING		1.6L L4 1600cc 98 CID		



USMW	Years	Application	Engine	USMW	Years	Application	Engine	
<b>US5057</b>	1997-2003	CHEVROLET MONZA	1.6L L4 1600cc 98 CID	<b>US5072</b>	1993	CADILLAC DEVILLE	4.6L V8 4573cc 279 CID	
	1999	CHEVROLET TIGRA	1.6L L4 1600cc 98 CID		1995-1999	OLDSMOBILE AURORA	4.0L V8 244 CID	
	1999-2003	CHEVROLET CHEVY	1.6L L4 1600cc 98 CID		1995-2002	CADILLAC ELDRADO	4.6L V8 281 CID	
	2000	CHEVROLET MILENIO	1.6L L4 1600cc 98 CID		1995-2004	CADILLAC SEVILLE	4.6L V8 281 CID	
	2000-2002	CHEVROLET VAGONETA	1.6L L4 1600cc 98 CID		1995-2005	CADILLAC DEVILLE	4.6L V8 281 CID	
	2002	CHEVROLET CORSA	1.4L L4 1389cc 85 CID		1996-1997	CADILLAC DEVILLE	4.9L V8 4900cc 300 CID	
	2002	CHEVROLET MONZA POP	1.4L L4 1400cc 85 CID		2001-2003	OLDSMOBILE AURORA	4.0L V8 244 CID	
	2002-2003	CHEVROLET POP	1.6L L4 1600cc 98 CID		2004-2005	PONTIAC BONNEVILLE	4.6L V8 281 CID	
	2004-2009	CHEVROLET CHEVY	1.6L L4 1606cc 98 CID		<b>US5073</b>	1992	CHEVROLET C1500	5.7L V8 350 CID
	2010-2012	CHEVROLET CHEVY	1.6L L4 1598cc 98 CID			1992	CHEVROLET C1500 SUBURBAN	5.7L V8 350 CID
<b>US5058</b>	1989-1997	GEO METRO	1.0L L3 993cc 61 CID	1992		CHEVROLET C2500 SUBURBAN	5.7L V8 350 CID	
	1989-2001	SUZUKI SWIFT	1.3L L4 1298cc 79 CID	1992		CHEVROLET K1500 SUBURBAN	5.7L V8 350 CID	
	1995-1997	GEO METRO	1.3L L4 1295cc 79 CID	1992		CHEVROLET K2500 SUBURBAN	5.7L V8 350 CID	
	1998-2000	CHEVROLET METRO	1.0L L3 993cc 61 CID	1992		GMC C1500	5.7L V8 350 CID	
	1998-2001	CHEVROLET METRO	1.3L L4 1295cc 79 CID	1992		GMC C1500 SUBURBAN	5.7L V8 350 CID	
	<b>US5062</b>	1988-1991	GMC R1500 SUBURBAN	6.2L V8 379 CID		1992	GMC C2500 SUBURBAN	5.7L V8 350 CID
		1988-1991	GMC R2500 SUBURBAN	6.2L V8 379 CID		1992	GMC K1500 SUBURBAN	5.7L V8 350 CID
		1988-1991	GMC V1500 SUBURBAN	6.2L V8 379 CID		1992	GMC K2500 SUBURBAN	5.7L V8 350 CID
		1988-1991	GMC V2500 SUBURBAN	6.2L V8 379 CID	<b>US5074</b>	1996-1997	GMC C1500	6.5L V8 395 CID
		1988-1993	CHEVROLET C1500	6.2L V8 379 CID		1996-1997	GMC YUKON	6.5L V8 395 CID
1988-1993		CHEVROLET C2500	6.2L V8 379 CID	1996-1998		AM GENERAL HUMMER	6.5L V8 395 CID	
1988-1993		CHEVROLET C3500	6.2L V8 379 CID	1996-1998		CHEVROLET C1500	6.5L V8 395 CID	
1988-1993		CHEVROLET K1500	6.2L V8 379 CID	1996-1998		CHEVROLET EXPRESS 2500	6.5L V8 395 CID	
1988-1993		CHEVROLET K2500	6.2L V8 379 CID	1996-1998		CHEVROLET EXPRESS 3500	6.5L V8 395 CID	
1988-1993		CHEVROLET K3500	6.2L V8 379 CID	1996-1998		CHEVROLET K1500	6.5L V8 395 CID	
1988-1993	GMC C1500	6.2L V8 379 CID	1996-1998	GMC K1500		6.5L V8 395 CID		
1988-1993	GMC C2500	6.2L V8 379 CID	1996-1998	GMC SAVANA 2500		6.5L V8 395 CID		
1988-1993	GMC C3500	6.2L V8 379 CID	1996-1998	GMC SAVANA 3500		6.5L V8 395 CID		
1988-1993	GMC K1500	6.2L V8 379 CID	1996-1999	CHEVROLET C1500 SUBURBAN	6.5L V8 395 CID			
1988-1993	GMC K2500	6.2L V8 379 CID	1996-1999	CHEVROLET C2500	6.5L V8 395 CID			
1988-1993	GMC K3500	6.2L V8 379 CID	1996-1999	CHEVROLET C2500 SUBURBAN	6.5L V8 395 CID			
1989-1991	CHEVROLET R1500 SUBURBAN	6.2L V8 379 CID	1996-1999	CHEVROLET C3500	6.5L V8 395 CID			
1989-1991	CHEVROLET R2500 SUBURBAN	6.2L V8 379 CID	1996-1999	CHEVROLET K1500 SUBURBAN	6.5L V8 395 CID			
1989-1991	CHEVROLET V1500 SUBURBAN	6.2L V8 379 CID	1996-1999	CHEVROLET K2500	6.5L V8 395 CID			
1989-1991	CHEVROLET V2500 SUBURBAN	6.2L V8 379 CID	1996-1999	CHEVROLET K2500 SUBURBAN	6.5L V8 395 CID			
1992-1996	CHEVROLET C2500	6.5L V8 395 CID	1996-1999	CHEVROLET K3500	6.5L V8 395 CID			
1992-1996	CHEVROLET C3500	6.5L V8 395 CID	1996-1999	CHEVROLET TAHOE	6.5L V8 395 CID			
1992-1996	CHEVROLET K2500	6.5L V8 395 CID	1996-1999	GMC C1500 SUBURBAN	6.5L V8 395 CID			
1992-1996	CHEVROLET K3500	6.5L V8 395 CID	1996-1999	GMC C2500	6.5L V8 395 CID			
1992-1996	GMC C2500	6.5L V8 395 CID	1996-1999	GMC C2500 SUBURBAN	6.5L V8 395 CID			
1992-1996	GMC C3500	6.5L V8 395 CID	1996-1999	GMC C3500	6.5L V8 395 CID			
1992-1996	GMC K2500	6.5L V8 395 CID	1996-1999	GMC K1500 SUBURBAN	6.5L V8 395 CID			
1992-1996	GMC K3500	6.5L V8 395 CID	1996-1999	GMC K2500	6.5L V8 395 CID			
1994	CHEVROLET BLAZER	6.5L V8 395 CID	1996-1999	GMC K2500 SUBURBAN	6.5L V8 395 CID			
1994-1995	CHEVROLET G20	6.5L V8 395 CID	1996-1999	GMC K3500	6.5L V8 395 CID			
1994-1995	GMC G2500	6.5L V8 395 CID	1997-1998	CHEVROLET P30	6.5L V8 395 CID			
1994-1996	AM GENERAL HUMMER	6.5L V8 395 CID	1997-1998	GMC P3500	6.5L V8 395 CID			
1994-1996	CHEVROLET C1500	6.5L V8 395 CID	<b>US5075</b>	1996	OLDSMOBILE 98	3.8L V6 3800cc 231 CID		
1994-1996	CHEVROLET C2500 SUBURBAN	6.5L V8 395 CID		1996-1999	BUICK RIVIERA	3.8L V6 3800cc 231 CID		
1994-1996	CHEVROLET G30	6.5L V8 395 CID		1996-1999	OLDSMOBILE 88	3.8L V6 3800cc 231 CID		
1994-1996	CHEVROLET K1500	6.5L V8 395 CID		1996-1999	OLDSMOBILE LSS	3.8L V6 3800cc 231 CID		
1994-1996	CHEVROLET K2500 SUBURBAN	6.5L V8 395 CID		1996-2002	CHEVROLET CAMARO	3.8L V6 3800cc 231 CID		
1994-1996	CHEVROLET P30	6.5L V8 395 CID		1996-2002	PONTIAC FIREBIRD	3.8L V6 3800cc 231 CID		
1994-1996	GMC C1500	6.5L V8 395 CID		1996-2004	BUICK REGAL	3.8L V6 3800cc 231 CID		
1994-1996	GMC C2500 SUBURBAN	6.5L V8 395 CID		1996-2005	BUICK LESABRE	3.8L V6 3800cc 231 CID		
1994-1996	GMC G3500	6.5L V8 395 CID		1996-2005	BUICK PARK AVENUE	3.8L V6 3800cc 231 CID		
1994-1996	GMC K1500	6.5L V8 395 CID		1996-2005	PONTIAC BONNEVILLE	3.8L V6 3800cc 231 CID		
1994-1996	GMC K2500 SUBURBAN	6.5L V8 395 CID	1997-1998	OLDSMOBILE REGENCY	3.8L V6 3800cc 231 CID			
1994-1996	GMC P3500	6.5L V8 395 CID	1997-2008	PONTIAC GRAND PRIX	3.8L V6 3800cc 231 CID			
1994-1996	GMC YUKON	6.5L V8 395 CID	1998-1999	CHEVROLET LUMINA	3.8L V6 3800cc 231 CID			
1995-1996	CHEVROLET C1500 SUBURBAN	6.5L V8 395 CID	1998-1999	OLDSMOBILE INTRIGUE	3.8L V6 3800cc 231 CID			
1995-1996	CHEVROLET K1500 SUBURBAN	6.5L V8 395 CID	1998-2005	CHEVROLET MONTE CARLO	3.8L V6 3800cc 231 CID			
1995-1996	CHEVROLET TAHOE	6.5L V8 395 CID	2000-2005	CHEVROLET IMPALA	3.8L V6 3800cc 231 CID			
1995-1996	GMC C1500 SUBURBAN	6.5L V8 395 CID	2005-2009	BUICK LACROSSE	3.8L V6 3800cc 231 CID			
1995-1996	GMC K1500 SUBURBAN	6.5L V8 395 CID	2006-2008	BUICK LUCERNE	3.8L V6 3800cc 231 CID			
<b>US5063</b>	1992	CHEVROLET CORVETTE	5.7L V8 350 CID	<b>US5076</b>	1996-1998	BUICK SKYLARK	2.4L L4 2392cc 146 CID	
	<b>US5064</b>	1993	CADILLAC ALLANTE		4.6L V8 281 CID	1996-1998	OLDSMOBILE ACHIEVA	2.4L L4 2392cc 146 CID
1993-1994		CADILLAC ELDRADO	4.6L V8 281 CID		1996-2001	PONTIAC GRAND AM	2.4L L4 2392cc 146 CID	
1993-1994		CADILLAC SEVILLE	4.6L V8 281 CID		1996-2002	CHEVROLET CAVALIER	2.4L L4 2392cc 146 CID	
1994		CADILLAC DEVILLE	4.6L V8 281 CID		1996-2002	PONTIAC SUNFIRE	2.4L L4 2392cc 146 CID	
<b>US5066</b>	1993-1996	CHEVROLET CORVETTE	5.7L V8 350 CID		1997-1999	CHEVROLET MALIBU	2.4L L4 2392cc 146 CID	
	<b>US5067</b>	1985	BUICK SOMERSET REGAL		2.5L L4 2474cc 151 CID	1999-2001	OLDSMOBILE ALERO	2.4L L4 2392cc 146 CID
1985-1987		OLDSMOBILE CALAIS	2.5L L4 2474cc 151 CID		2000-2001	CHEVROLET MALIBU	2.4L L4 2395cc 146 CID	
1985-1987		OLDSMOBILE CUTLASS CIERA	2.5L L4 2474cc 151 CID		1996-1997	CHEVROLET BOSS TRUCK	5.7L V8 5700cc 350 CID	
1985-1991		PONTIAC GRAND AM	2.5L L4 2474cc 151 CID		1996-1997	CHEVROLET C25	5.7L V8 5700cc 350 CID	
1986-1987		BUICK SOMERSET	2.5L L4 2474cc 151 CID	1996-1997	CHEVROLET SILVERADO	5.7L V8 5700cc 350 CID		
1986-1991		BUICK SKYLARK	2.5L L4 2474cc 151 CID	1996-1998	CHEVROLET C1500	4.3L V6 262 CID		
1987		OLDSMOBILE CUTLASS CRUISER	2.5L L4 2474cc 151 CID	1996-1998	CHEVROLET C2500	5.0L V8 305 CID		
<b>US5068</b>		1993-1997	CHEVROLET CAMARO	5.7L V8 350 CID	1996-1998	CHEVROLET K1500	4.3L V6 262 CID	
		1993-1997	PONTIAC FIREBIRD	5.7L V8 350 CID	1996-1998	GMC C1500	4.3L V6 262 CID	
<b>US5069</b>		1994-1996	BUICK COMMERCIAL CHASSIS	5.7L V8 350 CID	1996-1998	GMC C2500	5.0L V8 305 CID	
	1994-1996	BUICK ROADMASTER	5.7L V8 350 CID	1996-1998	GMC K1500	4.3L V6 262 CID		
	1994-1996	CADILLAC COMMERCIAL CHASSIS	5.7L V8 350 CID	1996-1999	CHEVROLET C1500	5.0L V8 305 CID		
	1994-1996	CADILLAC FLEETWOOD	5.7L V8 350 CID	1996-1999	CHEVROLET C1500	5.7L V8 350 CID		
	1994-1996	CHEVROLET CAPRICE	4.3L V8 265 CID	1996-1999	CHEVROLET C1500 SUBURBAN	5.7L V8 350 CID		
	1994-1996	CHEVROLET CAPRICE	5.7L V8 350 CID	1996-1999	CHEVROLET C2500 SUBURBAN	5.7L V8 350 CID		
<b>US5070</b>	1993-1995	CHEVROLET IMPALA	5.7L V8 350 CID	1996-1999	CHEVROLET K1500	5.0L V8 305 CID		
	1993-1995	CHEVROLET CAMARO	3.4L V6 207 CID	1996-1999	CHEVROLET K1500	5.7L V8 350 CID		
	1993-1995	PONTIAC FIREBIRD	3.4L V6 207 CID	1996-1999	CHEVROLET K1500 SUBURBAN	5.7L V8 350 CID		

WATER PUMPS

USMW	Years	Application	Engine	USMW	Years	Application	Engine	
<b>US5077</b>	1996-1999	CHEVROLET K2500 SUBURBAN	5.7L V8 350 CID	<b>US5077H</b>	1996-1999	GMC K2500 SUBURBAN	5.7L V8 350 CID	
	1996-1999	CHEVROLET P30	4.3L V6 262 CID		1996-1999	GMC P3500	4.3L V6 262 CID	
	1996-1999	GMC C1500	5.0L V8 305 CID		1996-1999	GMC P3500	5.7L V8 350 CID	
	1996-1999	GMC C1500	5.7L V8 350 CID		1996-1999	GMC YUKON	5.7L V8 350 CID	
	1996-1999	GMC C1500 SUBURBAN	5.7L V8 350 CID		1996-2000	CHEVROLET C2500	5.7L V8 350 CID	
	1996-1999	GMC C2500 SUBURBAN	5.7L V8 350 CID		1996-2000	CHEVROLET C3500	5.7L V8 350 CID	
	1996-1999	GMC K1500	5.0L V8 305 CID		1996-2000	CHEVROLET K2500	5.7L V8 350 CID	
	1996-1999	GMC K1500	5.7L V8 350 CID		1996-2000	CHEVROLET K3500	5.7L V8 350 CID	
	1996-1999	GMC K1500 SUBURBAN	5.7L V8 350 CID		1996-2000	CHEVROLET TAHOE	5.7L V8 350 CID	
	1996-1999	GMC K2500 SUBURBAN	5.7L V8 350 CID		1996-2000	GMC C2500	5.7L V8 350 CID	
	1996-1999	GMC P3500	4.3L V6 262 CID		1996-2000	GMC C3500	5.7L V8 350 CID	
	1996-1999	GMC P3500	5.7L V8 350 CID		1996-2000	GMC K2500	5.7L V8 350 CID	
	1996-2000	CHEVROLET C2500	5.7L V8 350 CID		1996-2000	GMC K3500	5.7L V8 350 CID	
	1996-2000	CHEVROLET C3500	5.7L V8 350 CID		1996-2001	GMC JIMMY	4.3L V6 262 CID	
	1996-2000	CHEVROLET K2500	5.7L V8 350 CID		1996-2001	OLDSMOBILE BRAVADA	4.3L V6 262 CID	
	1996-2000	CHEVROLET K3500	5.7L V8 350 CID		1996-2002	CHEVROLET EXPRESS 1500	5.0L V8 305 CID	
	1996-2000	CHEVROLET TAHOE	5.7L V8 350 CID		1996-2002	CHEVROLET EXPRESS 1500	5.7L V8 350 CID	
	1996-2000	GMC C2500	5.7L V8 350 CID		1996-2002	CHEVROLET EXPRESS 2500	5.0L V8 305 CID	
	1996-2000	GMC C3500	5.7L V8 350 CID		1996-2002	CHEVROLET EXPRESS 2500	5.7L V8 350 CID	
	1996-2000	GMC K2500	5.7L V8 350 CID		1996-2002	CHEVROLET EXPRESS 3500	5.7L V8 350 CID	
	1996-2000	GMC K3500	5.7L V8 350 CID		1996-2002	GMC SAVANA 1500	5.0L V8 305 CID	
	1996-2000	GMC YUKON	5.7L V8 350 CID		1996-2002	GMC SAVANA 1500	5.7L V8 350 CID	
	1996-2001	GMC JIMMY	4.3L V6 262 CID		1996-2002	GMC SAVANA 2500	5.0L V8 305 CID	
	1996-2001	OLDSMOBILE BRAVADA	4.3L V6 262 CID		1996-2002	GMC SAVANA 2500	5.7L V8 350 CID	
	1996-2002	CHEVROLET EXPRESS 1500	5.0L V8 305 CID		1996-2002	GMC SAVANA 3500	5.7L V8 350 CID	
	1996-2002	CHEVROLET EXPRESS 1500	5.7L V8 350 CID		1996-2004	CHEVROLET S10	4.3L V6 262 CID	
	1996-2002	CHEVROLET EXPRESS 2500	5.0L V8 305 CID		1996-2004	GMC SONOMA	4.3L V6 262 CID	
	1996-2002	CHEVROLET EXPRESS 2500	5.7L V8 350 CID		1996-2005	CHEVROLET ASTRO	4.3L V6 262 CID	
	1996-2002	CHEVROLET EXPRESS 3500	5.7L V8 350 CID		1996-2005	CHEVROLET BLAZER	4.3L V6 262 CID	
	1996-2002	GMC SAVANA 1500	5.0L V8 305 CID		1996-2005	CHEVROLET EXPRESS 2500	4.3L V6 262 CID	
	1996-2002	GMC SAVANA 1500	5.7L V8 350 CID		1996-2005	GMC SAFARI	4.3L V6 262 CID	
	1996-2002	GMC SAVANA 2500	5.0L V8 305 CID		1996-2005	GMC SAVANA 2500	4.3L V6 262 CID	
	1996-2002	GMC SAVANA 2500	5.7L V8 350 CID		1996-2011	CHEVROLET EXPRESS 1500	4.3L V6 262 CID	
	1996-2002	GMC SAVANA 3500	5.7L V8 350 CID		1996-2011	GMC SAVANA 1500	4.3L V6 262 CID	
	1996-2004	CHEVROLET S10	4.3L V6 262 CID		1997-1999	CHEVROLET P30	5.7L V8 350 CID	
	1996-2004	GMC SONOMA	4.3L V6 262 CID		1997-1999	ISUZU HOMBRE	4.3L V6 4294cc	
	1996-2005	CHEVROLET ASTRO	4.3L V6 262 CID		1998	CHEVROLET K2500	5.0L V8 305 CID	
	1996-2005	CHEVROLET BLAZER	4.3L V6 262 CID		1998	GMC K2500	5.0L V8 305 CID	
	1996-2005	CHEVROLET EXPRESS 2500	4.3L V6 262 CID		1999-2000	CADILLAC ESCALADE	5.7L V8 350 CID	
	1996-2005	GMC SAFARI	4.3L V6 262 CID		1999-2011	CHEVROLET SILVERADO 1500	4.3L V6 262 CID	
	1996-2005	GMC SAVANA 2500	4.3L V6 262 CID		1999-2011	GMC SIERRA 1500	4.3L V6 262 CID	
	1996-2012	CHEVROLET EXPRESS 1500	4.3L V6 262 CID		2000	ISUZU HOMBRE	4.3L V6 262 CID	
	1996-2012	GMC SAVANA 1500	4.3L V6 262 CID		2001	CHEVROLET P30	4.3L V6 4300cc 262 CID	
	1997-1999	CHEVROLET P30	5.7L V8 350 CID		2001-2002	CHEVROLET SUBURBAN 1500	5.7L V8 350 CID	
	1997-1999	ISUZU HOMBRE	4.3L V6 4294cc		<b>US5078</b>	1990	CHEVROLET C60	6.0L V8 366 CID
	1998	CHEVROLET C2500	5.7L V8 5700cc 350 CID			1990	CHEVROLET C60	7.0L V8 427 CID
	1998	CHEVROLET K2500	5.0L V8 305 CID			1990	CHEVROLET C70	6.0L V8 366 CID
	1998	GMC K2500	5.0L V8 305 CID			1990	CHEVROLET C70	7.0L V8 427 CID
	1998-1999	CHEVROLET P31 VAN	5.7L V8 5737cc 350 CID			1990	CHEVROLET P60	7.0L V8 6998cc 427 CID
	1999	CHEVROLET C1500	4.3L V6 4300cc 262 CID			1990	GMC C6000	6.0L V8 366 CID
	1999-2000	CADILLAC ESCALADE	5.7L V8 350 CID			1990	GMC C6000	7.0L V8 427 CID
	1999-2012	CHEVROLET SILVERADO 1500	4.3L V6 262 CID			1990	GMC C7000	6.0L V8 366 CID
	1999-2013	GMC SIERRA 1500	4.3L V6 262 CID			1990	GMC C7000	7.0L V8 427 CID
	2000	CHEVROLET C1500	5.7L V8 5737cc 350 CID			1990	GMC P6000	7.0L V8 6998cc 427 CID
	2000	CHEVROLET K1500	5.7L V8 5737cc 350 CID			1990-1991	CHEVROLET B60	6.0L V8 366 CID
	2000	CHEVROLET K2500	5.7L V8 5737cc 350 CID			1990-1991	CHEVROLET C5500 KODIAK	6.0L V8 366 CID
	2000	ISUZU HOMBRE	4.3L V6 262 CID			1990-1991	GMC B6000	6.0L V8 366 CID
2001	CHEVROLET P30 VAN	4.3L V6 4300cc 262 CID	1990-1991	GMC C5000 TOPKICK		6.0L V8 366 CID		
2003	CHEVROLET SONORA	4.3L V6 4300cc 262 CID	1990-1996	CHEVROLET C60 KODIAK		6.0L V8 366 CID		
2007	CHEVROLET SILVERADO 1500 CLASSIC	4.3L V6 262 CID	1990-1996	CHEVROLET C60 KODIAK		7.0L V8 6998cc 427 CID		
2007	GMC SIERRA 1500 CLASSIC	4.3L V6 262 CID	1990-1996	CHEVROLET C70 KODIAK		6.0L V8 366 CID		
2010-2013	CHEVROLET EXPRESS	4.3L V6 4300cc 262 CID	1990-1996	CHEVROLET C70 KODIAK		7.0L V8 6998cc 427 CID		
2013	CHEVROLET SILVERADO 1500	4.3L V6 4293cc 262 CID	1990-1996	GMC C6000 TOPKICK		6.0L V8 366 CID		
2013	GMC SAVANA 1500	4.3L V6 4293cc 262 CID	1990-1996	GMC C6000 TOPKICK		7.0L V8 6998cc 427 CID		
2013-2014	CHEVROLET EXPRESS 1500	4.3L V6 4293cc 262 CID	1990-1996	GMC C7000 TOPKICK		6.0L V8 366 CID		
2013-2014	CHEVROLET SILVERADO 1500	4.3L V6 4300cc 262 CID	1990-1996	GMC C7000 TOPKICK		7.0L V8 6998cc 427 CID		
2014	GMC SAVANA 1500	4.3L V6 262 CID	1992-1996	CHEVROLET P60		7.0L V8 6998cc 427 CID		
<b>US5077H</b>	1996-1998	CHEVROLET C1500	4.3L V6 262 CID	1992-1996		CHEVROLET P6000	7.0L V8 6998cc 427 CID	
	1996-1998	CHEVROLET C2500	5.0L V8 305 CID	1992-1996		GMC P6500	6.0L V8 366 CID	
	1996-1998	CHEVROLET K1500	4.3L V6 262 CID	1992-1996		GMC P6500	7.0L V8 6998cc 427 CID	
	1996-1998	GMC C1500	4.3L V6 262 CID	1993-1998		CHEVROLET B7	6.0L V8 366 CID	
	1996-1998	GMC C2500	5.0L V8 305 CID	1993-1998		GMC B7	6.0L V8 366 CID	
	1996-1998	GMC K1500	4.3L V6 262 CID	1994-1998		CHEVROLET B7	7.0L V8 6998cc 427 CID	
	1996-1999	CHEVROLET C1500	5.0L V8 305 CID	1994-1998		GMC B7	7.0L V8 6998cc 427 CID	
	1996-1999	CHEVROLET C1500	5.7L V8 350 CID	1997-1998		CHEVROLET C6500 KODIAK	6.0L V8 366 CID	
	1996-1999	CHEVROLET C1500 SUBURBAN	5.7L V8 350 CID	1997-1998		CHEVROLET C6500 KODIAK	7.0L V8 6998cc 427 CID	
	1996-1999	CHEVROLET C2500 SUBURBAN	5.7L V8 350 CID	1997-1998		CHEVROLET C7500 KODIAK	6.0L V8 366 CID	
	1996-1999	CHEVROLET K1500	5.0L V8 305 CID	1997-1998		CHEVROLET C7500 KODIAK	7.0L V8 6998cc 427 CID	
	1996-1999	CHEVROLET K1500	5.7L V8 350 CID	1997-1998		CHEVROLET T6500	6.0L V8 366 CID	
	1996-1999	CHEVROLET K1500 SUBURBAN	5.7L V8 350 CID	1997-1998		CHEVROLET T7500	6.0L V8 366 CID	
	1996-1999	CHEVROLET K2500 SUBURBAN	5.7L V8 350 CID	1997-1998		GMC C6500 TOPKICK	6.0L V8 366 CID	
	1996-1999	CHEVROLET P30	4.3L V6 262 CID	1997-1998		GMC C6500 TOPKICK	7.0L V8 6998cc 427 CID	
	1996-1999	GMC C1500	5.0L V8 305 CID	1997-1998		GMC C7500 TOPKICK	6.0L V8 366 CID	
	1996-1999	GMC C1500	5.7L V8 350 CID	1997-1998		GMC T6500	6.0L V8 366 CID	
	1996-1999	GMC C1500 SUBURBAN	5.7L V8 350 CID	1997-1998		GMC T7500	6.0L V8 366 CID	
	1996-1999	GMC C2500 SUBURBAN	5.7L V8 350 CID	<b>US5079</b>		1994-1997	SAAB 900	2.5L V6 2498cc
	1996-1999	GMC K1500	5.0L V8 305 CID			1995-1997	SAAB 9000	3.0L V6 2961cc 181 CID
	1996-1999	GMC K1500	5.7L V8 350 CID			1997-2001	CADILLAC CATERA	3.0L V6 2962cc 181 CID
	1996-1999	GMC K1500 SUBURBAN	5.7L V8 350 CID					

USMW	Years	Application	Engine	USMW	Years	Application	Engine
<b>US5079</b>	1999-2003	<b>SAAB 9-5</b>	3.0L V6 2961cc 181 CID	<b>US5089H</b>	2001-2006	<b>CHEVROLET SUBURBAN 2500</b>	8.1L V8 496 CID
	2000	<b>SATURN LS2</b>	3.0L V6 3000cc 181 CID		2001-2006	<b>GMC SIERRA 2500 HD</b>	8.1L V8 496 CID
	2000	<b>SATURN LW2</b>	3.0L V6 3000cc 181 CID		2001-2006	<b>GMC SIERRA 3500</b>	8.1L V8 496 CID
	2001-2003	<b>SATURN LW300</b>	3.0L V6 3000cc 181 CID		2001-2006	<b>GMC YUKON XL 2500</b>	8.1L V8 496 CID
	2001-2005	<b>SATURN L300</b>	3.0L V6 3000cc 181 CID		2002-2006	<b>CHEVROLET AVALANCHE 2500</b>	8.1L V8 496 CID
	2002-2003	<b>SATURN VUE</b>	3.0L V6 3000cc 181 CID		2007	<b>CHEVROLET SILVERADO 2500 HD CLASSIC</b>	8.1L V8 496 CID
	2003	<b>CHEVROLET VECTRA</b>	3.2L V6 3199cc 195 CID		2007	<b>CHEVROLET SILVERADO 3500 CLASSIC</b>	8.1L V8 496 CID
	2003-2004	<b>CADILLAC CTS</b>	3.2L V6 197 CID		2007	<b>GMC SIERRA 2500 HD CLASSIC</b>	8.1L V8 496 CID
	2004-2005	<b>CHEVROLET VECTRA</b>	3.2L V6 3171cc 193 CID		2007	<b>GMC SIERRA 3500 CLASSIC</b>	8.1L V8 496 CID
	<b>US5081</b>	1997-2004	<b>CHEVROLET CORVETTE</b>		5.7L V8 350 CID	<b>US5090</b>	2001-2002
1998-2002		<b>CHEVROLET CAMARO</b>	5.7L V8 350 CID	2001-2002	<b>GMC SAVANA 3500</b>		8.1L V8 496 CID
1998-2002		<b>PONTIAC FIREBIRD</b>	5.7L V8 350 CID	<b>US5092</b>	2000	<b>SATURN LS</b>	2.2L L4 2198cc 134 CID
2004		<b>PONTIAC GTO</b>	5.7L V8 350 CID		2000	<b>SATURN LS1</b>	2.2L L4 2198cc 134 CID
<b>US5084</b>	1966-1967	<b>CHEVROLET C50</b>	6.0L V8 5999cc 366 CID		2000	<b>SATURN LW1</b>	2.2L L4 2198cc 134 CID
	1966-1967	<b>CHEVROLET C60</b>	6.0L V8 5999cc 366 CID		2001-2002	<b>SATURN L100</b>	2.2L L4 2198cc 134 CID
	1980	<b>CHEVROLET C70</b>	7.4L V8 454 CID		2001-2003	<b>SATURN L200</b>	2.2L L4 2198cc 134 CID
	1980	<b>GMC C7000</b>	7.4L V8 454 CID		2001-2003	<b>SATURN LW200</b>	2.2L L4 2198cc 134 CID
	1980-1985	<b>CHEVROLET B60</b>	7.0L V8 427 CID		2002-2004	<b>OLDSMOBILE ALERO</b>	2.2L L4 2198cc 134 CID
	1980-1985	<b>GMC B6000</b>	7.0L V8 427 CID		2002-2005	<b>CHEVROLET CAVALIER</b>	2.2L L4 2198cc 134 CID
	1980-1990	<b>CHEVROLET B60</b>	6.0L V8 366 CID		2002-2005	<b>PONTIAC GRAND AM</b>	2.2L L4 2198cc 134 CID
	1980-1990	<b>CHEVROLET C60</b>	6.0L V8 366 CID		2002-2005	<b>PONTIAC SUNFIRE</b>	2.2L L4 2198cc 134 CID
	1980-1990	<b>CHEVROLET C70</b>	6.0L V8 366 CID	2002-2006	<b>CHEVROLET ZAFIRA</b>	2.2L L4 2190cc 134 CID	
	1980-1990	<b>CHEVROLET C70</b>	7.0L V8 427 CID	2002-2007	<b>SATURN VUE</b>	2.2L L4 2198cc 134 CID	
1980-1990	<b>GMC B6000</b>	6.0L V8 366 CID	2003-2005	<b>CHEVROLET VECTRA</b>	2.2L L4 2190cc 134 CID		
1980-1990	<b>GMC C6000</b>	6.0L V8 366 CID	2003-2007	<b>SATURN ION</b>	2.2L L4 2198cc 134 CID		
1980-1990	<b>GMC C7000</b>	6.0L V8 366 CID	2003-2011	<b>SAAB 9-3</b>	2.0L L4 1985cc		
1980-1990	<b>GMC C7000</b>	7.0L V8 427 CID	2004	<b>SATURN L300</b>	2.2L L4 2198cc 134 CID		
1990	<b>CHEVROLET C60</b>	7.0L V8 427 CID	2004-2005	<b>CHEVROLET CLASSIC</b>	2.2L L4 2198cc 134 CID		
1990	<b>CHEVROLET C60 KODIAK</b>	6.0L V8 366 CID	2004-2007	<b>SATURN ION</b>	2.0L L4 122 CID		
1990	<b>CHEVROLET C60 KODIAK</b>	7.0L V8 6998cc 427 CID	2004-2008	<b>CHEVROLET MALIBU</b>	2.2L L4 2198cc 134 CID		
1990	<b>CHEVROLET C70 KODIAK</b>	6.0L V8 366 CID	2005-2006	<b>PONTIAC G4</b>	2.2L L4 2190cc 134 CID		
1990	<b>CHEVROLET C70 KODIAK</b>	7.0L V8 6998cc 427 CID	2005-2007	<b>CHEVROLET COBALT</b>	2.0L L4 122 CID		
1990	<b>CHEVROLET C5500 KODIAK</b>	6.0L V8 366 CID	2005-2010	<b>CHEVROLET COBALT</b>	2.2L L4 2198cc 134 CID		
1990	<b>CHEVROLET P60</b>	7.0L V8 6998cc 427 CID	2006	<b>PONTIAC G4</b>	2.4L L4 2395cc 146 CID		
1990	<b>GMC C5000 TOPKICK</b>	6.0L V8 366 CID	2006-2007	<b>SATURN ION</b>	2.4L L4 2384cc 145 CID		
1990	<b>GMC C6000</b>	7.0L V8 427 CID	2006-2008	<b>CHEVROLET COBALT</b>	2.4L L4 2384cc 145 CID		
1990	<b>GMC C6000 TOPKICK</b>	6.0L V8 366 CID	2006-2009	<b>PONTIAC SOLSTICE</b>	2.4L L4 2384cc 145 CID		
1990	<b>GMC C6000 TOPKICK</b>	7.0L V8 6998cc 427 CID	2006-2010	<b>PONTIAC G6</b>	2.4L L4 2384cc 145 CID		
1990	<b>GMC C7000 TOPKICK</b>	6.0L V8 366 CID	2006-2011	<b>CHEVROLET HHR</b>	2.2L L4 2198cc 134 CID		
1990	<b>GMC C7000 TOPKICK</b>	7.0L V8 6998cc 427 CID	2006-2011	<b>CHEVROLET HHR</b>	2.4L L4 2384cc 145 CID		
1990	<b>GMC P6000</b>	7.0L V8 6998cc 427 CID	2007-2008	<b>PONTIAC G5</b>	2.4L L4 2384cc 145 CID		
<b>US5085</b>	1999-2002	<b>OLDSMOBILE INTRIGUE</b>	3.5L V6 214 CID	2007-2009	<b>PONTIAC G5</b>	2.2L L4 2198cc 134 CID	
	2001-2002	<b>OLDSMOBILE AURORA</b>	3.5L V6 214 CID	2007-2009	<b>PONTIAC SOLSTICE</b>	2.0L L4 1998cc 122 CID	
<b>US5086</b>	1999	<b>CHEVROLET C1500 SUBURBAN</b>	6.5L V8 395 CID	2007-2009	<b>SATURN AURA</b>	2.4L L4 2384cc 145 CID	
	1999	<b>CHEVROLET C2500 SUBURBAN</b>	6.5L V8 395 CID	2007-2010	<b>SATURN SKY</b>	2.0L L4 1998cc 122 CID	
	1999	<b>CHEVROLET K1500 SUBURBAN</b>	6.5L V8 395 CID	2007-2010	<b>SATURN SKY</b>	2.4L L4 2384cc 145 CID	
	1999	<b>CHEVROLET K2500 SUBURBAN</b>	6.5L V8 395 CID	2007-2010	<b>SATURN VUE</b>	2.4L L4 2384cc 145 CID	
	1999	<b>CHEVROLET P30</b>	6.5L V8 395 CID	2008-2010	<b>CHEVROLET COBALT</b>	2.0L L4 1998cc 122 CID	
	1999	<b>GMC C1500 SUBURBAN</b>	6.5L V8 395 CID	2008-2010	<b>CHEVROLET HHR</b>	2.0L L4 1998cc 122 CID	
	1999	<b>GMC C2500 SUBURBAN</b>	6.5L V8 395 CID	2008-2014	<b>CHEVROLET MALIBU</b>	2.4L L4 2384cc 145 CID	
	1999	<b>GMC K1500 SUBURBAN</b>	6.5L V8 395 CID	2010-2011	<b>SAAB 9-3X</b>	2.0L L4 1985cc	
	1999	<b>GMC K2500 SUBURBAN</b>	6.5L V8 395 CID	2010-2015	<b>CHEVROLET CAPTIVA SPORT</b>	2.4L L4 2409cc 147 CID	
	1999	<b>GMC P3500</b>	6.5L V8 395 CID	2010-2016	<b>BUICK LACROSSE</b>	2.4L L4 2384cc 145 CID	
	1999-2000	<b>CHEVROLET C2500</b>	6.5L V8 395 CID	2010-2017	<b>CHEVROLET EQUINOX</b>	2.4L L4 2384cc 145 CID	
	1999-2000	<b>CHEVROLET C3500</b>	6.5L V8 395 CID	2010-2017	<b>GMC TERRAIN</b>	2.4L L4 2384cc 145 CID	
	1999-2000	<b>CHEVROLET K2500</b>	6.5L V8 395 CID	2011-2013	<b>BUICK REGAL</b>	2.0L L4 1998cc 122 CID	
	1999-2000	<b>CHEVROLET K3500</b>	6.5L V8 395 CID	2011-2017	<b>BUICK REGAL</b>	2.4L L4 2384cc 145 CID	
	1999-2000	<b>GMC C2500</b>	6.5L V8 395 CID	2012-2015	<b>CHEVROLET CAPTIVA SPORT</b>	2.4L L4 2384cc 145 CID	
	1999-2000	<b>GMC C3500</b>	6.5L V8 395 CID	2012-2017	<b>BUICK VERANO</b>	2.4L L4 2384cc 145 CID	
	1999-2000	<b>GMC K2500</b>	6.5L V8 395 CID	2013-2016	<b>BUICK VERANO</b>	2.0L L4 1998cc 122 CID	
	1999-2000	<b>GMC K3500</b>	6.5L V8 395 CID	2014	<b>CHEVROLET IMPALA</b>	2.4L L4 2384cc 145 CID	
	1999-2001	<b>AM GENERAL HUMMER</b>	6.5L V8 395 CID	<b>US5097</b>	2002-2004	<b>OLDSMOBILE BRAVADA</b>	4.2L L6 256 CID
	1999-2002	<b>CHEVROLET EXPRESS 2500</b>	6.5L V8 395 CID		2002-2006	<b>CHEVROLET TRAILBLAZER EXT</b>	4.2L L6 256 CID
1999-2002	<b>CHEVROLET EXPRESS 3500</b>	6.5L V8 395 CID	2002-2006		<b>GMC ENVOY XL</b>	4.2L L6 256 CID	
1999-2002	<b>GMC SAVANA 2500</b>	6.5L V8 395 CID	2002-2009		<b>CHEVROLET TRAILBLAZER</b>	4.2L L6 256 CID	
1999-2002	<b>GMC SAVANA 3500</b>	6.5L V8 395 CID	2002-2009		<b>GMC ENVOY</b>	4.2L L6 256 CID	
2002-2004	<b>HUMMER H1</b>	6.5L V8 395 CID	2003-2008		<b>ISUZU ASCENDER</b>	4.2L L6 256 CID	
<b>US5087</b>	2000	<b>CHEVROLET C2500</b>	5.7L V8 5737cc 350 CID		2004-2005	<b>GMC ENVOY XUV</b>	4.2L L6 256 CID
	2001	<b>CHEVROLET SILVERADO 2500</b>	5.7L V8 5737cc 350 CID		2004-2006	<b>CHEVROLET COLORADO</b>	2.8L L4 2770cc 169 CID
	2001	<b>CHEVROLET SUBURBAN 1500</b>	5.7L V8 5737cc 350 CID		2004-2006	<b>CHEVROLET COLORADO</b>	3.5L L5 3460cc 211 CID
	2001-2003	<b>CHEVROLET SILVERADO 3500</b>	5.7L V8 5737cc 350 CID		2004-2006	<b>GMC CANYON</b>	2.8L L4 2770cc 169 CID
	2002	<b>CHEVROLET SUBURBAN 1500</b>	5.7L V8 5733cc 350 CID	2004-2006	<b>GMC CANYON</b>	3.5L L5 3460cc 211 CID	
	2002	<b>CHEVROLET SILVERADO 2500</b>	5.3L V8 5300cc 323 CID	2004-2007	<b>BUICK RAINIER</b>	4.2L L6 256 CID	
	2003	<b>CHEVROLET SONORA</b>	6.0L V8 6000cc 364 CID	2005-2009	<b>SAAB 9-7X</b>	4.2L L6 256 CID	
	2003-2004	<b>CHEVROLET SONORA</b>	5.3L V8 5300cc 323 CID	2006	<b>HUMMER H3</b>	3.5L L5 3460cc 211 CID	
	<b>US5089</b>	2001-2006	<b>CHEVROLET SILVERADO 2500 HD</b>	8.1L V8 496 CID	2006	<b>ISUZU I-280</b>	2.8L L4 2770cc 169 CID
		2001-2006	<b>CHEVROLET SILVERADO 3500</b>	8.1L V8 496 CID	2006	<b>ISUZU I-350</b>	3.5L L5 3460cc 211 CID
2001-2006		<b>CHEVROLET SUBURBAN 2500</b>	8.1L V8 496 CID	2007-2008	<b>ISUZU I-290</b>	2.9L L4 2921cc 178 CID	
2001-2006		<b>GMC SIERRA 2500 HD</b>	8.1L V8 496 CID	2007-2008	<b>ISUZU I-370</b>	3.7L L5 3654cc 223 CID	
2001-2006		<b>GMC SIERRA 3500</b>	8.1L V8 496 CID	2007-2010	<b>HUMMER H3</b>	3.7L L5 3654cc 223 CID	
2001-2006		<b>GMC YUKON XL 2500</b>	8.1L V8 496 CID	2007-2012	<b>CHEVROLET COLORADO</b>	2.9L L4 2921cc 178 CID	
2002-2006		<b>CHEVROLET AVALANCHE 2500</b>	8.1L V8 496 CID	2007-2012	<b>CHEVROLET COLORADO</b>	3.7L L5 3654cc 223 CID	
2007		<b>CHEVROLET SILVERADO 2500 HD CLASSIC</b>	8.1L V8 496 CID	2007-2012	<b>GMC CANYON</b>	2.9L L4 2921cc 178 CID	
2007		<b>CHEVROLET SILVERADO 3500 CLASSIC</b>	8.1L V8 496 CID	2007-2012	<b>GMC CANYON</b>	3.7L L5 3654cc 223 CID	
2007		<b>GMC SIERRA 2500 HD CLASSIC</b>	8.1L V8 496 CID	2009-2010	<b>HUMMER H3T</b>	3.7L L5 3654cc 223 CID	
2007	<b>GMC SIERRA 3500 CLASSIC</b>	8.1L V8 496 CID	<b>US5099</b>	2003-2008	<b>PONTIAC VIBE</b>	1.8L L4 1794cc	
<b>US5089H</b>	2001-2006	<b>CHEVROLET SILVERADO 2500 HD</b>		8.1L V8 496 CID	2004-2005	<b>AUDI ALLROAD QUATTRO</b>	4.2L V8 4172cc
	2001-2006	<b>CHEVROLET SILVERADO 3500</b>	8.1L V8 496 CID	2004-2009	<b>AUDI S4</b>	4.2L V8 4163cc	

WATER PUMPS



USMW	Years	Application	Engine	USMW	Years	Application	Engine
<b>US6000</b>	2005-2006	<b>AUDI A6 QUATTRO</b>	4.2L V8 4163cc	<b>US6009</b>	2009-2010	<b>HUMMER H3T</b>	5.3L V8 5328cc 325 CID
	2007-2008	<b>AUDI RS4</b>	4.2L V8 4172cc		2009-2012	<b>CHEVROLET COLORADO</b>	5.3L V8 5328cc 325 CID
<b>US6001</b>	2002-2008	<b>MINI COOPER</b>	1.6L L4 1600cc	2009-2012	<b>GMC CANYON</b>	5.3L V8 5328cc 325 CID	
<b>US6003</b>	2002-2004	<b>BMW 745I</b>	4.4L V8 4398cc	2009-2013	<b>CADILLAC ESCALADE</b>	6.0L V8 5967cc 364 CID	
	2003-2005	<b>BMW 760LI</b>	6.0L V12 5972cc	2009-2013	<b>CHEVROLET SILVERADO 1500</b>	6.2L V8 6162cc 376 CID	
<b>US6006</b>	2004-2005	<b>BMW 760I</b>	6.0L V12 5972cc	2009-2014	<b>CHEVROLET EXPRESS 4500</b>	6L V8 5967cc 364 CID	
	2010-2014	<b>FORD F-150</b>	6.2L V8 6210cc 379 CID	2009-2014	<b>GMC SAVANA 4500</b>	6L V8 5967cc 364 CID	
	2011-2014	<b>FORD F-350 XL</b>	6.2L V8 6200cc 378 CID	2010-2011	<b>CHEVROLET EXPRESS</b>	5.3L V8 5300cc 323 CID	
	2011-2014	<b>FORD F-350 XLT</b>	6.2L V8 6200cc 378 CID	2010-2011	<b>CHEVROLET SILVERADO 2500</b>	4.8L V8 4800cc 293 CID	
	2011-2014	<b>FORD LOBO</b>	6.2L V8 6200cc 378 CID	2010-2011	<b>CHEVROLET SILVERADO 2500</b>	5.3L V8 5300cc 323 CID	
	2011-2018	<b>FORD F-250 SUPER DUTY</b>	6.2L V8 6210cc 379 CID	2010-2012	<b>CHEVROLET SUBURBAN</b>	5.3L V8 5300cc 325 CID	
	2011-2018	<b>FORD F-350 SUPER DUTY</b>	6.2L V8 6210cc 379 CID	2010-2012	<b>GMC SIERRA</b>	5.3L V8 5300cc 323 CID	
	2015	<b>FORD F-350</b>	6.2L V8 6200cc 378 CID	2010-2013	<b>CHEVROLET EXPRESS</b>	6.0L V8 5967cc 364 CID	
	2017-2018	<b>FORD E-350 SUPER DUTY</b>	6.2L V8 6210cc 379 CID	2011	<b>CHEVROLET CHEYENNE 2500</b>	5.3L V8 5300cc 323 CID	
	<b>US6007</b>	2004-2006	<b>DODGE SPRINTER 2500</b>	2.7L L5 2687cc 165 CID	2011-2014	<b>GMC YUKON</b>	6.2L V8 6162cc 376 CID
2004-2006		<b>DODGE SPRINTER 3500</b>	2.7L L5 2687cc 165 CID	2012-2013	<b>CHEVROLET EXPRESS</b>	5.3L V8 5328cc 325 CID	
<b>US6008</b>	2004-2006	<b>MERCEDES-BENZ SPRINTER</b>	2.7L L5 2685cc 165 CID	2012-2015	<b>CHEVROLET CHEYENNE 2500</b>	5.3L V8 5328cc 325 CID	
	2003	<b>DODGE SPRINTER 2500</b>	2.7L L5 2687cc 165 CID	2013	<b>CHEVROLET SILVERADO 2500</b>	4.8L V8 4800cc 293 CID	
<b>US6009</b>	2003	<b>DODGE SPRINTER 3500</b>	2.7L L5 2687cc 165 CID	2013	<b>CHEVROLET SILVERADO 2500</b>	5.3L V8 5328cc 325 CID	
	2007	<b>BUICK RAINIER</b>	5.3L V8 5328cc 325 CID	2014	<b>CHEVROLET SILVERADO 2500</b>	5.3L V8 5328cc 323 CID	
	2007	<b>CHEVROLET SILVERADO 1500 CLASSIC</b>	4.8L V8 294 CID	2014	<b>GMC SIERRA</b>	5.3L V8 5300cc 323 CID	
	2007	<b>CHEVROLET SILVERADO 1500 CLASSIC</b>	5.3L V8 5328cc 325 CID	2015-2016	<b>CHEVROLET EXPRESS 4500</b>	6.0L V8 5967cc 364 CID	
	2007	<b>CHEVROLET SILVERADO 1500 CLASSIC</b>	6.0L V8 5967cc 364 CID	2015-2016	<b>CHEVROLET SILVERADO 2500</b>	5.3L V8 5328cc 325 CID	
	2007	<b>CHEVROLET SILVERADO 1500 HD CLASSIC</b>	6.0L V8 5967cc 364 CID	2015-2016	<b>CHEVROLET SILVERADO 3500</b>	6.0L V8 5967cc 364 CID	
	2007	<b>CHEVROLET SILVERADO 2500 HD CLASSIC</b>	6.0L V8 5967cc 364 CID	2015-2016	<b>GMC SAVANA 4500</b>	6.0L V8 5967cc 364 CID	
	2007	<b>CHEVROLET SILVERADO 3500 CLASSIC</b>	6.0L V8 5967cc 364 CID	2016-2017	<b>CHEVROLET SUBURBAN 3500 HD</b>	6.0L V8 5967cc 364 CID	
	2007	<b>GMC SIERRA 1500 CLASSIC</b>	4.8L V8 294 CID	<b>US6009-T</b>	2007	<b>BUICK RAINIER</b>	5.3L V8 5328cc 325 CID
	2007	<b>GMC SIERRA 1500 CLASSIC</b>	5.3L V8 5328cc 325 CID	2007	<b>CHEVROLET SILVERADO 1500 CLASSIC</b>	4.8L V8 294 CID	
	2007	<b>GMC SIERRA 1500 CLASSIC</b>	6.0L V8 5967cc 364 CID	2007	<b>CHEVROLET SILVERADO 1500 CLASSIC</b>	5.3L V8 5328cc 325 CID	
	2007	<b>GMC SIERRA 1500 HD CLASSIC</b>	6.0L V8 5967cc 364 CID	2007	<b>CHEVROLET SILVERADO 1500 CLASSIC</b>	6.0L V8 5967cc 364 CID	
	2007	<b>GMC SIERRA 2500 HD CLASSIC</b>	6.0L V8 5967cc 364 CID	2007	<b>CHEVROLET SILVERADO 1500 HD CLASSIC</b>	6.0L V8 5967cc 364 CID	
	2007	<b>GMC SIERRA 3500 CLASSIC</b>	6.0L V8 5967cc 364 CID	2007	<b>CHEVROLET SILVERADO 2500 HD CLASSIC</b>	6.0L V8 5967cc 364 CID	
	2007	<b>HUMMER H2</b>	6.0L V8 5967cc 364 CID	2007	<b>CHEVROLET SILVERADO 3500 CLASSIC</b>	6.0L V8 5967cc 364 CID	
	2007-2008	<b>CHEVROLET TRAILBLAZER</b>	5.3L V8 5328cc 325 CID	2007	<b>GMC SIERRA 1500 CLASSIC</b>	4.8L V8 294 CID	
	2007-2009	<b>CHEVROLET AVALANCHE</b>	6.0L V8 5967cc 364 CID	2007	<b>GMC SIERRA 1500 CLASSIC</b>	5.3L V8 5328cc 325 CID	
	2007-2009	<b>CHEVROLET SUBURBAN 1500</b>	6.0L V8 5967cc 364 CID	2007	<b>GMC SIERRA 1500 CLASSIC</b>	6.0L V8 5967cc 364 CID	
	2007-2009	<b>CHEVROLET TAHOE</b>	4.8L V8 294 CID	2007	<b>GMC SIERRA 1500 HD CLASSIC</b>	6.0L V8 5967cc 364 CID	
	2007-2009	<b>CHEVROLET TRAILBLAZER</b>	6.0L V8 5967cc 364 CID	2007	<b>GMC SIERRA 2500 HD CLASSIC</b>	6.0L V8 5967cc 364 CID	
	2007-2009	<b>GMC ENVOY</b>	5.3L V8 5328cc 325 CID	2007	<b>GMC SIERRA 3500 CLASSIC</b>	6.0L V8 5967cc 364 CID	
	2007-2009	<b>GMC YUKON</b>	4.8L V8 294 CID	2007	<b>HUMMER H2</b>	6.0L V8 5967cc 364 CID	
	2007-2009	<b>GMC YUKON</b>	6.2L V8 6162cc 376 CID	2007-2008	<b>CHEVROLET TRAILBLAZER</b>	5.3L V8 5328cc 325 CID	
	2007-2009	<b>GMC YUKON XL 1500</b>	6.0L V8 5967cc 364 CID	2007-2009	<b>CHEVROLET AVALANCHE</b>	6.0L V8 5967cc 364 CID	
	2007-2009	<b>SAAB 9-7X</b>	5.3L V8 5328cc 325 CID	2007-2009	<b>CHEVROLET SUBURBAN 1500</b>	6.0L V8 5967cc 364 CID	
	2007-2010	<b>CHEVROLET CHEYENNE</b>	5.3L V8 5300cc 323 CID	2007-2009	<b>CHEVROLET TAHOE</b>	4.8L V8 294 CID	
	2007-2013	<b>CADILLAC ESCALADE EXT</b>	6.2L V8 6162cc 376 CID	2007-2009	<b>CHEVROLET TRAILBLAZER</b>	6.0L V8 5967cc 364 CID	
	2007-2013	<b>CHEVROLET AVALANCHE</b>	5.3L V8 5328cc 325 CID	2007-2009	<b>GMC ENVOY</b>	5.3L V8 5328cc 325 CID	
	2007-2013	<b>CHEVROLET SILVERADO 1500</b>	4.8L V8 294 CID	2007-2009	<b>GMC YUKON</b>	4.8L V8 294 CID	
	2007-2013	<b>CHEVROLET SILVERADO 1500</b>	5.3L V8 5328cc 325 CID	2007-2009	<b>GMC YUKON</b>	6.2L V8 6162cc 376 CID	
	2007-2013	<b>CHEVROLET SILVERADO 1500</b>	6.0L V8 5967cc 364 CID	2007-2009	<b>GMC YUKON XL 1500</b>	6.0L V8 5967cc 364 CID	
	2007-2013	<b>CHEVROLET SUBURBAN 2500</b>	6.0L V8 5967cc 364 CID	2007-2009	<b>SAAB 9-7X</b>	5.3L V8 5328cc 325 CID	
	2007-2013	<b>GMC SIERRA 1500</b>	4.8L V8 294 CID	2007-2013	<b>CADILLAC ESCALADE EXT</b>	6.2L V8 6162cc 376 CID	
	2007-2013	<b>GMC SIERRA 1500</b>	5.3L V8 5328cc 325 CID	2007-2013	<b>CHEVROLET AVALANCHE</b>	5.3L V8 5328cc 325 CID	
	2007-2013	<b>GMC SIERRA 1500</b>	6.0L V8 5967cc 364 CID	2007-2013	<b>CHEVROLET SILVERADO 1500</b>	4.8L V8 294 CID	
	2007-2013	<b>GMC SIERRA 1500</b>	6.2L V8 6162cc 376 CID	2007-2013	<b>CHEVROLET SILVERADO 1500</b>	5.3L V8 5328cc 325 CID	
	2007-2014	<b>GMC YUKON XL 2500</b>	6.0L V8 5967cc 364 CID	2007-2013	<b>CHEVROLET SILVERADO 1500</b>	6.0L V8 5967cc 364 CID	
	2007-2014	<b>CADILLAC ESCALADE</b>	6.2L V8 6162cc 376 CID	2007-2013	<b>CHEVROLET SUBURBAN 2500</b>	6.0L V8 5967cc 364 CID	
	2007-2014	<b>CADILLAC ESCALADE ESV</b>	6.2L V8 6162cc 376 CID	2007-2013	<b>GMC SIERRA 1500</b>	4.8L V8 294 CID	
	2007-2014	<b>CHEVROLET EXPRESS 1500</b>	5.3L V8 5328cc 325 CID	2007-2013	<b>GMC SIERRA 1500</b>	5.3L V8 5328cc 325 CID	
	2007-2014	<b>CHEVROLET SUBURBAN 1500</b>	5.3L V8 5328cc 325 CID	2007-2013	<b>GMC SIERRA 1500</b>	6.0L V8 5967cc 364 CID	
	2007-2014	<b>CHEVROLET TAHOE</b>	5.3L V8 5328cc 325 CID	2007-2013	<b>GMC SIERRA 1500</b>	6.2L V8 6162cc 376 CID	
	2007-2014	<b>GMC SAVANA 1500</b>	5.3L V8 5328cc 325 CID	2007-2013	<b>GMC SIERRA 1500</b>	6.0L V8 5967cc 364 CID	
	2007-2014	<b>GMC YUKON</b>	5.3L V8 5328cc 325 CID	2007-2013	<b>GMC SIERRA 1500</b>	6.0L V8 5967cc 364 CID	
	2007-2014	<b>GMC YUKON XL 1500</b>	5.3L V8 5328cc 325 CID	2007-2013	<b>GMC SIERRA 1500</b>	6.2L V8 6162cc 376 CID	
	2007-2014	<b>GMC YUKON XL 1500</b>	6.2L V8 6162cc 376 CID	2007-2014	<b>CADILLAC ESCALADE ESV</b>	6.2L V8 6162cc 376 CID	
2007-2017	<b>CHEVROLET EXPRESS 2500</b>	4.8L V8 294 CID	2007-2014	<b>CHEVROLET EXPRESS 1500</b>	5.3L V8 5328cc 325 CID		
2007-2017	<b>CHEVROLET EXPRESS 2500</b>	6.0L V8 5967cc 364 CID	2007-2014	<b>CHEVROLET EXPRESS 2500</b>	4.8L V8 294 CID		
2007-2017	<b>CHEVROLET EXPRESS 3500</b>	4.8L V8 294 CID	2007-2014	<b>CHEVROLET EXPRESS 2500</b>	6.0L V8 5967cc 364 CID		
2007-2017	<b>CHEVROLET EXPRESS 3500</b>	6.0L V8 5967cc 364 CID	2007-2014	<b>CHEVROLET EXPRESS 3500</b>	4.8L V8 294 CID		
2007-2017	<b>CHEVROLET SILVERADO 2500 HD</b>	6.0L V8 5967cc 364 CID	2007-2014	<b>CHEVROLET EXPRESS 3500</b>	6.0L V8 5967cc 364 CID		
2007-2017	<b>CHEVROLET SILVERADO 3500 HD</b>	6.0L V8 5967cc 364 CID	2007-2014	<b>CHEVROLET SILVERADO 2500 HD</b>	6.0L V8 5967cc 364 CID		
2007-2017	<b>GMC SAVANA 2500</b>	4.8L V8 294 CID	2007-2014	<b>CHEVROLET SILVERADO 3500 HD</b>	6.0L V8 5967cc 364 CID		
2007-2017	<b>GMC SAVANA 2500</b>	6.0L V8 5967cc 364 CID	2007-2014	<b>CHEVROLET SUBURBAN 1500</b>	5.3L V8 5328cc 325 CID		
2007-2017	<b>GMC SAVANA 3500</b>	4.8L V8 294 CID	2007-2014	<b>CHEVROLET TAHOE</b>	5.3L V8 5328cc 325 CID		
2007-2017	<b>GMC SAVANA 3500</b>	6.0L V8 5967cc 364 CID	2007-2014	<b>GMC SAVANA 1500</b>	5.3L V8 5328cc 325 CID		
2007-2017	<b>GMC SAVANA 3500</b>	6.0L V8 5967cc 364 CID	2007-2014	<b>GMC SAVANA 2500</b>	4.8L V8 294 CID		
2007-2017	<b>GMC SIERRA 2500 HD</b>	6.0L V8 5967cc 364 CID	2007-2014	<b>GMC SAVANA 2500</b>	6.0L V8 5967cc 364 CID		
2007-2017	<b>GMC SIERRA 3500 HD</b>	6.0L V8 5967cc 364 CID	2007-2014	<b>GMC SAVANA 3500</b>	4.8L V8 294 CID		
2008	<b>CHEVROLET EXPRESS</b>	5.3L V8 5300cc 323 CID	2007-2014	<b>GMC SAVANA 3500</b>	6.0L V8 5967cc 364 CID		
2008-2009	<b>CHEVROLET TAHOE</b>	6.2L V8 6162cc 376 CID	2007-2014	<b>GMC SIERRA 2500 HD</b>	6.0L V8 5967cc 364 CID		
2008-2009	<b>HUMMER H2</b>	6.2L V8 6162cc 376 CID	2007-2014	<b>GMC SIERRA 3500 HD</b>	6.0L V8 5967cc 364 CID		
2008-2009	<b>SAAB 9-7X</b>	6.0L V8 5967cc 364 CID	2007-2014	<b>GMC YUKON</b>	5.3L V8 5328cc 325 CID		
2008-2010	<b>HUMMER H3</b>	5.3L V8 5328cc 325 CID	2007-2014	<b>GMC YUKON XL 1500</b>	5.3L V8 5328cc 325 CID		
2008-2013	<b>CHEVROLET SILVERADO 3500</b>	6.0L V8 5967cc 364 CID	2007-2014	<b>GMC YUKON XL 1500</b>	6.2L V8 6162cc 376 CID		
2008-2013	<b>CHEVROLET TAHOE</b>	6.0L V8 5967cc 364 CID	2008-2009	<b>CHEVROLET TAHOE</b>	6.2L V8 6162cc 376 CID		
2008-2013	<b>GMC YUKON</b>	6.0L V8 5967cc 364 CID	2008-2009	<b>HUMMER H2</b>	6.2L V8 6162cc 376 CID		
2009	<b>GMC YUKON</b>	6.2L V8 6162cc 378 CID	2008-2009	<b>SAAB 9-7X</b>	6.0L V8 5967cc 364 CID		

USMW	Years	Application	Engine	USMW	Years	Application	Engine		
<b>US6009-T</b>	2008-2010	<b>HUMMER H3</b>	5.3L V8 5328cc 325 CID	<b>US6038</b>	2014-2018	<b>JEEP CHEROKEE</b>	2.4L L4 2360cc 144 CID		
	2008-2013	<b>CHEVROLET TAHOE</b>	6.0L V8 5967cc 364 CID		2015-2018	<b>JEEP RENEGADE</b>	2.4L L4 2360cc 144 CID		
	2008-2013	<b>GMC YUKON</b>	6.0L V8 5967cc 364 CID		2015-2018	<b>RAM PROMASTER CITY</b>	2.4L L4 2360cc 144 CID		
	2009-2010	<b>HUMMER H3T</b>	5.3L V8 5328cc 325 CID		2016-2018	<b>FIAT 500X</b>	2.4L L4 2360cc 144 CID		
	2009-2012	<b>CHEVROLET COLORADO</b>	5.3L V8 5328cc 325 CID		<b>US6046</b>	2004-2008	<b>CHEVROLET AVEO</b>	1.6L L4 1598cc 98 CID	
	2009-2012	<b>GMC CANYON</b>	5.3L V8 5328cc 325 CID			2005-2007	<b>PONTIAC WAVE</b>	1.6L L4 1598cc 98 CID	
	2009-2013	<b>CADILLAC ESCALADE</b>	6.0L V8 5967cc 364 CID			2006-2008	<b>PONTIAC G3</b>	1.6L L4 1606cc 98 CID	
	2009-2013	<b>CHEVROLET SILVERADO 1500</b>	6.2L V8 6162cc 376 CID			2007-2008	<b>CHEVROLET AVEO5</b>	1.6L L4 1598cc 98 CID	
	2009-2014	<b>CHEVROLET EXPRESS 4500</b>	6L V8 5967cc 364 CID			2010-2016	<b>CHEVROLET AVEO</b>	1.6L L4 1598cc 97 CID	
	2011-2014	<b>GMC YUKON</b>	6.2L V8 6162cc 376 CID		2012	<b>CHEVROLET CRUZE</b>	1.8L L4 1796cc 110 CID		
	<b>US6018</b>	2006	<b>HONDA FIT</b>		1.5L H4 1496cc 91 CID	<b>US6047</b>	2005-2017	<b>TOYOTA AVALON</b>	3.5L V6 3456cc
2007-2008		<b>HONDA FIT</b>	1.5L L4 1497cc	2006-2012	<b>TOYOTA RAV4</b>		3.5L V6 3456cc		
<b>US6020</b>	2006	<b>CHEVROLET MONTE CARLO</b>	3.9L V6 3880cc 237 CID	2007-2015	<b>LEXUS RX350</b>		3.5L V6 3456cc		
	2006-2007	<b>BUICK TERRAZA</b>	3.9L V6 3880cc 237 CID	2007-2016	<b>TOYOTA SIENNA</b>		3.5L V6 3456cc		
	2006-2007	<b>CHEVROLET MALIBU</b>	3.9L V6 3880cc 237 CID	2007-2017	<b>LEXUS ES350</b>		3.5L V6 3456cc		
	2006-2007	<b>CHEVROLET MONTE CARLO</b>	3.5L V6 3490cc 213 CID	2007-2017	<b>TOYOTA CAMRY</b>		3.5L V6 3456cc		
	2006-2007	<b>SATURN RELAY</b>	3.9L V6 3880cc 237 CID	2008-2016	<b>TOYOTA HIGHLANDER</b>		3.5L V6 3456cc		
	2006-2009	<b>CHEVROLET UPLANDER</b>	3.9L V6 3880cc 237 CID	2009-2015	<b>TOYOTA VENZA</b>		3.5L V6 3456cc		
	2006-2009	<b>PONTIAC G6</b>	3.9L V6 3880cc 237 CID	2010-2015	<b>LEXUS RX450H</b>		3.5L V6 3456cc		
	2006-2009	<b>PONTIAC MONTANA</b>	3.9L V6 3880cc 237 CID	<b>US6048</b>	2006-2010		<b>HYUNDAI SONATA</b>	3.3L V6 3342cc	
	2006-2011	<b>CHEVROLET IMPALA</b>	3.5L V6 3490cc 213 CID		2006-2010	<b>KIA SEDONA</b>	3.8L V6 3778cc		
	2006-2011	<b>CHEVROLET IMPALA</b>	3.9L V6 3880cc 237 CID		2006-2011	<b>HYUNDAI AZERA</b>	3.8L V6 3778cc		
	2007-2008	<b>SATURN AURA</b>	3.5L V6 3490cc 213 CID		2007-2008	<b>HYUNDAI ENTOURAGE</b>	3.8L V6 3778cc		
	2007-2010	<b>CHEVROLET MALIBU</b>	3.5L V6 3490cc 213 CID		2007-2009	<b>HYUNDAI SANTA FE</b>	3.3L V6 3342cc		
	2007-2010	<b>PONTIAC G6</b>	3.5L V6 3490cc 213 CID		2007-2009	<b>KIA AMANTI</b>	3.8L V6 3778cc		
	2008-2009	<b>SATURN VUE</b>	3.5L V6 3490cc 213 CID		2007-2009	<b>KIA SORENTO</b>	3.8L V6 3778cc		
	2009-2011	<b>BUICK LUCERNE</b>	3.9L V6 3880cc 237 CID		2007-2012	<b>HYUNDAI VERACRUZ</b>	3.8L V6 3778cc		
	<b>US6022</b>	2005-2009	<b>AUDI A4</b>		2.0L L4 1984cc 121 CID	2007-2017	<b>HYUNDAI AZERA</b>	3.3L V6 3342cc	
		2005-2009	<b>AUDI A4 QUATTRO</b>		2.0L L4 1984cc 121 CID	2008-2009	<b>KIA SORENTO</b>	3.8L V6 3778cc	
2006-2007		<b>AUDI A3</b>	2.0L H4 1984cc 121 CID		2009	<b>KIA BORREGO</b>	3.3L V6 3342cc		
2006-2008		<b>AUDI A3</b>	2.0L L4 1984cc 121 CID		2009-2014	<b>HYUNDAI GENESIS</b>	3.8L V6 3778cc		
2006-2008		<b>VOLKSWAGEN GTI</b>	2.0L L4 1984cc 121 CID		2010-2012	<b>HYUNDAI SANTA FE</b>	3.5L V6 3470cc		
2006-2008		<b>VOLKSWAGEN JETTA</b>	2.0L L4 1984cc 121 CID		2010-2016	<b>HYUNDAI GENESIS COUPE</b>	3.8L V6 3778cc		
2006-2008		<b>VOLKSWAGEN PASSAT</b>	2.0L L4 1984cc 121 CID		2011-2012	<b>KIA SEDONA</b>	3.5L V6 3470cc		
2007-2009		<b>VOLKSWAGEN EOS</b>	2.0L L4 1984cc 121 CID		2011-2013	<b>KIA SORENTO</b>	3.5L V6 3470cc		
2007-2010		<b>VOLKSWAGEN BORA</b>	2.0L H4 1984cc 121 CID	2013-2017	<b>HYUNDAI SANTA FE</b>	3.3L V6 3342cc			
2008-2009		<b>AUDI TT</b>	2.0L L4 1984cc 121 CID	2014	<b>KIA SEDONA</b>	3.5L V6 3470cc			
2009-2015		<b>AUDI TT QUATTRO</b>	2.0L L4 1984cc 121 CID	2014-2016	<b>KIA CADENZA</b>	3.3L V6 3342cc			
2010		<b>VOLKSWAGEN JETTA</b>	2.0L H4 1984cc 121 CID	2014-2017	<b>KIA SORENTO</b>	3.3L V6 3342cc			
2010		<b>VOLKSWAGEN PASSAT</b>	2.0L H4 1985cc 121 CID	2015-2017	<b>KIA SEDONA</b>	3.3L V6 3342cc			
2012		<b>VOLKSWAGEN CLASICO</b>	2.0L H4 1984cc 121 CID	2016-2017	<b>KIA K900</b>	3.8L V6 3778cc			
<b>US6023</b>		2007	<b>MAZDA CX-9</b>	3.5L V6 3496cc 213 CID	<b>US6049</b>	2006-2010	<b>SUBARU FORESTER</b>	2.5L H4 2458cc	
	2007-2010	<b>FORD EDGE</b>	3.5L V6 3496cc 213 CID	2006-2011		<b>SUBARU IMPREZA</b>	2.5L H4 2458cc		
	2007-2010	<b>LINCOLN MKX</b>	3.5L V6 3496cc 213 CID	2006-2012		<b>SUBARU LEGACY</b>	2.5L H4 2458cc		
	2007-2011	<b>LINCOLN MKZ</b>	3.5L V6 3496cc 213 CID	2006-2012		<b>SUBARU OUTBACK</b>	2.5L H4 2458cc		
	2008-2009	<b>FORD TAURUS X</b>	3.5L V6 3496cc 213 CID	2010-2011		<b>SUBARU IMPREZA</b>	2.5L L4 2457cc 150 CID		
	2008-2009	<b>MERCURY SABLE</b>	3.5L V6 3496cc 213 CID	2011-2013		<b>SUBARU LEGACY</b>	2.5L L4 2457cc 150 CID		
	2008-2010	<b>FORD TAURUS</b>	3.5L V6 3496cc 213 CID	2013		<b>SUBARU OUTBACK</b>	2.5L L4 2457cc 150 CID		
	2008-2010	<b>MAZDA CX-9</b>	3.7L V6 3726cc 227 CID	<b>US6050</b>		2005-2009	<b>VOLKSWAGEN BORA</b>	2.5L L5 2480cc 151 CID	
	2009-2010	<b>FORD FLEX</b>	3.5L V6 3496cc 213 CID			2005-2014	<b>VOLKSWAGEN JETTA</b>	2.5L L5 2480cc 151 CID	
	2009-2010	<b>LINCOLN MKS</b>	3.7L V6 3726cc 227 CID			2006-2009	<b>VOLKSWAGEN RABBIT</b>	2.5L L5 2480cc 151 CID	
	2009-2010	<b>MAZDA 6</b>	3.7L V6 3726cc 227 CID		2006-2010	<b>VOLKSWAGEN BEETLE</b>	2.5L L5 2480cc 151 CID		
	2010	<b>LINCOLN MKS</b>	3.5L V6 3496cc 213 CID	2008-2011	<b>VOLKSWAGEN CRAFTER</b>	2.5L L5 2459cc 151 CID			
	2010	<b>LINCOLN MKT</b>	3.5L V6 3496cc 213 CID	2010-2014	<b>VOLKSWAGEN GOLF</b>	2.5L L5 2480cc 151 CID			
	2010	<b>LINCOLN MKT</b>	3.7L V6 3726cc 227 CID	2012-2014	<b>VOLKSWAGEN BEETLE</b>	2.5L L5 2480cc 151 CID			
2010-2011	<b>FORD FUSION</b>	3.5L V6 3496cc 213 CID	2012-2014	<b>VOLKSWAGEN PASSAT</b>	2.5L L5 2480cc 151 CID				
<b>US6030</b>	2003-2005	<b>MERCEDES-BENZ C230</b>	1.8L L4 1796cc	<b>US6056</b>	2006-2011	<b>HONDA CIVIC</b>	1.8L L4 1799cc		
	2004-2005	<b>VOLKSWAGEN JETTA</b>	1.9L L4 1896cc 116 CID		<b>US6075</b>	2005-2006	<b>MERCEDES-BENZ SLK350</b>	3.5L V6 3498cc	
<b>US6034</b>	2004-2005	<b>VOLKSWAGEN PASSAT</b>	2.0L L4 1967cc 120 CID	2006		<b>MERCEDES-BENZ C230</b>	2.5L V6 2496cc		
	2004-2006	<b>VOLKSWAGEN BEETLE</b>	1.9L L4 1896cc 116 CID	2006		<b>MERCEDES-BENZ C280</b>	3.0L V6 2996cc		
	2004-2006	<b>VOLKSWAGEN GOLF</b>	1.9L L4 1896cc 116 CID	2006		<b>MERCEDES-BENZ C350</b>	3.5L V6 3498cc		
	2009	<b>VOLKSWAGEN JETTA</b>	1.9L L4 1896cc 116 CID	2006		<b>MERCEDES-BENZ CLK350</b>	3.5L V6 3498cc		
	2009-2014	<b>VOLKSWAGEN JETTA</b>	2.0L L4 1968cc 120 CID	2006		<b>MERCEDES-BENZ E350</b>	3.5L V6 3498cc		
	2010-2013	<b>AUDI A3</b>	2.0L L4 1968cc 120 CID	2006		<b>MERCEDES-BENZ ML350</b>	3.5L V6 3498cc		
	2010-2014	<b>VOLKSWAGEN GOLF</b>	2.0L L4 1968cc 120 CID	2006		<b>MERCEDES-BENZ R350</b>	3.5L V6 3498cc		
	2013-2014	<b>VOLKSWAGEN BEETLE</b>	2.0L L4 1968cc 120 CID	2006		<b>MERCEDES-BENZ SLK280</b>	3.0L V6 2996cc		
	<b>US6037</b>	2003-2009	<b>TOYOTA 4RUNNER</b>	4.0L V6 3956cc 241 CID		<b>US6142</b>	2005-2011	<b>MERCEDES-BENZ SLK350</b>	3.5L V6 3498cc
		2005-2011	<b>TOYOTA TUNDRA</b>	4.0L V6 3956cc 241 CID			2006-2007	<b>MERCEDES-BENZ C230</b>	2.5L V6 2496cc
2005-2015		<b>TOYOTA TACOMA</b>	4.0L V6 3956cc 241 CID	2006-2007	<b>MERCEDES-BENZ C280</b>		3.0L V6 2996cc		
2007-2009		<b>TOYOTA FJ CRUISER</b>	4.0L V6 3956cc 241 CID	2006-2008	<b>MERCEDES-BENZ SLK280</b>		3.0L V6 2996cc		
<b>US6038</b>	2007-2009	<b>DODGE CALIBER</b>	1.8L L4 1798cc 110 CID	2006-2009	<b>MERCEDES-BENZ CLK350</b>		3.5L V6 3498cc		
	2007-2010	<b>CHRYSLER SEBRING</b>	2.4L L4 2360cc 144 CID	2006-2011	<b>MERCEDES-BENZ C350</b>		3.5L V6 3498cc		
	2007-2011	<b>DODGE CALIBER</b>	2.4L L4 2360cc 144 CID	2006-2011	<b>MERCEDES-BENZ E350</b>		3.5L V6 3498cc		
	2007-2012	<b>DODGE CALIBER</b>	2.0L L4 1998cc 122 CID	2006-2011	<b>MERCEDES-BENZ ML350</b>		3.5L V6 3498cc		
	2007-2017	<b>JEEP PATRIOT</b>	2.0L L4 1998cc 122 CID	2006-2011	<b>MERCEDES-BENZ R350</b>		3.5L V6 3498cc		
	2007-2017	<b>JEEP PATRIOT</b>	2.4L L4 2360cc 144 CID	2007	<b>MERCEDES-BENZ E280</b>		3.0L V6 2996cc 183 CID		
	2007-2018	<b>JEEP COMPASS</b>	2.4L L4 2360cc 144 CID	2008-2012	<b>MERCEDES-BENZ C300</b>		3.0L V6 2996cc		
	2008-2010	<b>DODGE AVENGER</b>	2.0L L4 2000cc 122 CID	2009-2011	<b>MERCEDES-BENZ SLK300</b>	3.0L V6 2996cc			
	2008-2011	<b>MITSUBISHI LANCER</b>	2.0L L4 1998cc 122 CID	2010-2012	<b>MERCEDES-BENZ GLK350</b>	3.5L V6 3498cc			
	2008-2011	<b>MITSUBISHI OUTLANDER</b>	2.4L L4 2360cc 144 CID	<b>US6143</b>	2006	<b>LEXUS GS300</b>	3.0L V6 2994cc		
	2008-2014	<b>DODGE AVENGER</b>	2.4L L4 2360cc 144 CID		2006-2015	<b>LEXUS IS250</b>	2.5L V6 2499cc		
	2008-2017	<b>JEEP COMPASS</b>	2.0L L4 1998cc 122 CID		2006-2017	<b>LEXUS IS350</b>	3.5L V6 3456cc		
	2009-2011	<b>MITSUBISHI LANCER</b>	2.4L L4 2360cc 144 CID		2007-2011	<b>LEXUS GS350</b>	3.5L V6 3456cc		
	2009-2018	<b>DODGE JOURNEY</b>	2.4L L4 2360cc 144 CID		2007-2011	<b>LEXUS GS450H</b>	3.5L V6 3456cc		
	2010	<b>CHRYSLER CIRRUS</b>	2.4L L4 2360cc 144 CID		2013-2015	<b>LEXUS GS350</b>	3.5L V6 3456cc		
2011	<b>MITSUBISHI OUTLANDER SPORT</b>	2.0L L4 1998cc 122 CID	2013-2017	<b>LEXUS GS450H</b>	3.5L V6 3456cc				
2011-2017	<b>CHRYSLER 200</b>	2.4L L4 2360cc 144 CID	2015-2017	<b>LEXUS RC350</b>	3.5L V6 3456cc				
2013-2016	<b>DODGE DART</b>	2.0L L4 1995cc 122 CID	2016-2017	<b>LEXUS IS300</b>	3.5L V6 3456cc				
2013-2016	<b>DODGE DART</b>	2.4L L4 2360cc 144 CID	2016-2017	<b>LEXUS RC300</b>	3.5L V6 3456cc				

WATER PUMPS

USMWW	Years	Application	Engine	USMWW	Years	Application	Engine	
<b>US6144</b>	2006-2009	FORD F-150	5.4L V8 330 CID	<b>US6198</b>	2013-2016	NISSAN PATHFINDER	3.5L V6 3498cc	
	2007-2008	FORD EXPEDITION	5.4L V8 330 CID		2014-2016	INFINITI QX60	3.5L V6 3498cc	
	2007-2008	FORD F-150	4.6L V8 281 CID	2016-2017	NISSAN MAXIMA	3.5L V6 3498cc		
	2007-2008	LINCOLN MARK LT	5.4L V8 330 CID	<b>US6211</b>	2014-2017	LEXUS ES300H	2.5L L4 2494cc 152 CID	
	2007-2008	LINCOLN NAVIGATOR	5.4L V8 330 CID		2014-2017	TOYOTA AVALON	2.5L L4 2494cc 152 CID	
	2009-2015	FORD F-550 SUPER DUTY	6.8L V10 415 CID	2014-2017	TOYOTA CAMRY	2.5L L4 2494cc 152 CID		
	2010	FORD F-250 SUPER DUTY	6.8L V10 415 CID	<b>US6212</b>	2005-2007	VOLKSWAGEN JETTA	1.9L L4 1896cc 116 CID	
	2010	FORD F-350 SUPER DUTY	6.8L V10 415 CID		2006-2008	VOLKSWAGEN EUROVAN	1.9L L4 1896cc 116 CID	
	2010-2015	FORD E-350 SUPER DUTY	6.8L V10 415 CID		2007-2010	VOLKSWAGEN BORA	1.9L L4 1896cc 116 CID	
	2010-2015	FORD E-450 SUPER DUTY	6.8L V10 415 CID		2010	VOLKSWAGEN JETTA	1.9L L4 1896cc 116 CID	
	2010-2015	FORD F-450 SUPER DUTY	6.8L V10 415 CID	<b>US6213</b>	2012-2015	HONDA CIVIC	2.4L L4 2354cc 144 CID	
	2011-2014	FORD F53	6.8L V10 415 CID		2013-2015	ACURA ILX	2.4L L4 2354cc 144 CID	
	2014	FORD F59	6.8L V10 415 CID	<b>US6215</b>	2006-2010	KIA OPTIMA	2.7L V6 2656cc	
	<b>US6145</b>	2005-2009	CHEVROLET EQUINOX		3.4L V6 207 CID	2007-2009	HYUNDAI SANTA FE	2.7L V6 2656cc
2006-2009		PONTIAC TORRENT	3.4L V6 207 CID		2007-2010	KIA RONDO	2.7L V6 2656cc	
<b>US6146</b>	2005-2008	AUDI A6 QUATTRO	3.2L V6 3123cc	<b>US6216</b>	2003-2011	HONDA CIVIC	1.3L L4 1339cc	
	2005-2009	AUDI A4 QUATTRO	3.2L V6 3123cc		2008	DODGE MAGNUM	2.7L V6 2736cc 167 CID	
	2006-2008	AUDI A4	3.2L V6 3123cc	2008-2010	CHRYSLER 300	2.7L V6 2736cc 167 CID		
	2006-2009	AUDI A6	3.2L V6 3123cc	2008-2010	CHRYSLER SEBRING	2.7L V6 2736cc 167 CID		
	2009-2011	AUDI A6 QUATTRO	3.0L V6 2995cc	2008-2010	DODGE AVENGER	2.7L V6 2736cc 167 CID		
	2009-2012	AUDI Q7	3.0L V6 2967cc 181 CID	2008-2010	DODGE CHARGER	2.7L V6 2736cc 167 CID		
	2009-2012	VOLKSWAGEN TOUAREG	3.0L V6 2967cc 181 CID	<b>US6218</b>	2007-2012	NISSAN SENTRA	2.0L L4 1997cc 122 CID	
	2010	AUDI A4	3.2L V6 3200cc 195 CID		2007-2012	NISSAN VERSA	1.8L L4 1798cc	
	2010-2012	AUDI S4	3.0L V6 2995cc		2009-2014	NISSAN CUBE	1.8L L4 1798cc	
	2010-2012	AUDI S5	3.0L V6 2995cc		2010-2012	NISSAN TIIDA	1.8L L4 1798cc 110 CID	
	2011-2013	AUDI Q7	3.0L V6 2967cc 182 CID	2013-2017	NISSAN NV200	2.0L L4 1997cc		
	2011-2015	AUDI Q7	3.0L V6 2995cc	2015-2017	CHEVROLET CITY EXPRESS	2.0L L4 1997cc		
	2012	AUDI Q5	3.0L V6 2967cc 182 CID	<b>US6219</b>	2006-2008	MAZDA MX-5	2.0L L4 1999cc 122 CID	
	2012	VOLKSWAGEN TOUAREG	3.0L V6 2967cc 182 CID		2006-2009	MAZDA 3	2.3L L4 2260cc	
<b>US6149</b>	2004	MITSUBISHI GALANT	2.4L L4 2351cc		2006-2013	MAZDA 3	2.0L L4 2000cc 122 CID	
	2004	MITSUBISHI LANCER	2.4L L4 2400cc		2006-2015	MAZDA MX-5 MIATA	2.0L L4 2000cc 122 CID	
	2004	MITSUBISHI OUTLANDER	2.4L L4 2351cc		2008-2010	MAZDA 5	2.3L L4 2260cc	
	2005-2006	MITSUBISHI LANCER	2.4L L4 2378cc		2010	MAZDA MX-5 GRAND TOURING	2.0L L4 1999cc 122 CID	
	2005-2006	MITSUBISHI OUTLANDER	2.4L L4 2378cc		2010-2011	MAZDA MX-5	2.0L L4 1999cc 122 CID	
	2005-2011	MITSUBISHI GALANT	2.4L L4 2378cc		2010-2012	MAZDA CX-7	2.5L L4 2488cc 152 CID	
	2006-2011	MITSUBISHI ECLIPSE	2.4L L4 2378cc		2010-2013	MAZDA 3	2.5L L4 2488cc 152 CID	
	<b>US6152</b>	2005-2006	MERCEDES-BENZ E320		3.2L L6 3222cc	2011-2013	MAZDA 6	2.5L L4 2488cc 152 CID
		2005-2008	PONTIAC GRAND PRIX	5.3L V8 5328cc 325 CID	2012	MAZDA MX-5 GRAND TOURING	2.0L L4 1999cc 122 CID	
	<b>US6154</b>	2006-2007	CHEVROLET MONTE CARLO	5.3L V8 5328cc 325 CID	2012-2015	MAZDA 5	2.5L L4 2488cc 152 CID	
		2006-2009	CHEVROLET IMPALA	5.3L V8 5328cc 325 CID	2013	MAZDA 3	2.0L L4 1998cc 122 CID	
	2008-2009	BUICK LACROSSE	5.3L V8 5328cc 325 CID	2013-2014	MAZDA MX-5	2.0L L4 1999cc 122 CID		
	<b>US6155</b>	2007-2008	MERCEDES-BENZ R320	3.0L V6 2987cc	<b>US6220</b>	2006-2010	HYUNDAI SONATA	2.4L L4 2359cc
		2007-2009	DODGE SPRINTER 2500	3.0L V6 2987cc		2006-2010	KIA OPTIMA	2.4L L4 2359cc
2007-2009		DODGE SPRINTER 3500	3.0L V6 2987cc	2007-2010		KIA RONDO	2.4L L4 2359cc	
2007-2009		JEEP GRAND CHEROKEE	3.0L V6 2985cc 182 CID	2010-2011		HYUNDAI TUCSON	2.4L L4 2359cc	
2007-2009		MERCEDES-BENZ E320	3.0L V6 2987cc	2010-2012		HYUNDAI SANTA FE	2.4L L4 2359cc	
2007-2009		MERCEDES-BENZ GL320	3.0L V6 2987cc	2010-2013		KIA FORTE	2.0L L4 1998cc 122 CID	
2007-2009		MERCEDES-BENZ ML320	3.0L V6 2987cc	2010-2013		KIA FORTE	2.4L L4 2359cc	
2010-2012		MERCEDES-BENZ R350	3.0L V6 2987cc	2010-2013		KIA FORTE KOUP	2.0L L4 1998cc 122 CID	
2010-2012		MERCEDES-BENZ SPRINTER 2500	3.0L V6 2987cc	2010-2013		KIA FORTE KOUP	2.4L L4 2359cc	
2010-2012		MERCEDES-BENZ SPRINTER 3500	3.0L V6 2987cc	2011		HYUNDAI TUCSON	2.0L L4 1975cc	
2010-2013		MERCEDES-BENZ GL350	3.0L V6 2987cc	2011-2013		KIA SORENTO	2.4L L4 2359cc	
2010-2013		MERCEDES-BENZ ML350	3.0L V6 2987cc	2011-2014		HYUNDAI SONATA	2.0L L4 1998cc 122 CID	
2011-2013		MERCEDES-BENZ E350	3.0L V6 2987cc	2011-2015		KIA OPTIMA	2.0L L4 1998cc 122 CID	
2012-2013		MERCEDES-BENZ S350	3.0L V6 2987cc	2011-2016		KIA SPORTAGE	2.0L L4 1998cc 122 CID	
<b>US6156</b>	2004-2008	MAZDA RX-8	1.3L R2 1308cc	2014	HYUNDAI TUCSON	2.4L L4 2359cc		
	<b>US6159</b>	2003-2004	MITSUBISHI LANCER	2.0L L4 2000cc	2014-2015	KIA OPTIMA	2.4L L4 2359cc	
2005		MITSUBISHI LANCER	2.0L L4 1997cc 122 CID	2014-2016	HYUNDAI SANTA FE SPORT	2.0L L4 1998cc 122 CID		
<b>US6160</b>	2006	SUBARU FORESTER	2.5L H4 2458cc	2014-2016	KIA SPORTAGE	2.4L L4 2359cc		
	<b>US6184</b>	2008	SATURN ASTRA	1.8L L4 1796cc 110 CID	<b>US6221</b>	2006-2009	VOLKSWAGEN PASSAT	3.6L V6 3597cc 219 CID
2009-2010		PONTIAC G3	1.6L L4 1598cc 98 CID	2007-2010		AUDI Q7	3.6L V6 3597cc 219 CID	
2009-2011		CHEVROLET AVEO	1.6L L4 1598cc 98 CID	2007-2010	VOLKSWAGEN TOUAREG	3.6L V6 3597cc 219 CID		
2009-2011		CHEVROLET AVEO5	1.6L L4 1598cc 98 CID	2009-2016	VOLKSWAGEN CC	3.6L V6 3597cc 219 CID		
2010-2012		CHEVROLET AVEO	1.6L L4 1598cc 97 CID	2012-2017	VOLKSWAGEN PASSAT	3.6L V6 3597cc 219 CID		
2010-2016		CHEVROLET CRUZE	1.8L L4 1796cc 110 CID	<b>US6222</b>	2007-2010	DODGE RAM 2500	6.7L L6 408 CID	
2012-2013		CHEVROLET SONIC	1.6L L4 1598cc 97 CID		2007-2010	DODGE RAM 3500	6.7L L6 408 CID	
2012-2017		CHEVROLET SONIC	1.8L L4 1796cc 110 CID		2010-2013	DODGE RAM 4000	6.7L L6 6700cc 409 CID	
2013-2015		CHEVROLET TRAX	1.8L L4 1796cc 110 CID		2011-2012	RAM 2500	6.7L L6 408 CID	
2014-2016		CHEVROLET SONIC	1.6L L4 1600cc 98 CID		2011-2012	RAM 3500	6.7L L6 408 CID	
2016		CHEVROLET CRUZE LIMITED	1.8L L4 1796cc 110 CID		2011-2012	RAM 4500	6.7L L6 408 CID	
2016		CHEVROLET CRUZE LIMITED	1.8L L4 1796cc 110 CID		2011-2012	RAM 5500	6.7L L6 408 CID	
<b>US6186</b>		2005-2007	FORD FIVE HUNDRED	3.0L V6 2968cc 181 CID	<b>US6223</b>	2007-2012	ACURA RDX	2.3L L4 2300cc
		2005-2007	FORD FREESTYLE	3.0L V6 2968cc 181 CID		2003-2005	INFINITI FX45	4.5L V8 4500cc
2005-2007	MERCURY MONTEGO	3.0L V6 2968cc 181 CID	2005-2006	INFINITI Q45	4.5L V8 4494cc			
<b>US6197</b>	2007-2017	TOYOTA TUNDRA	5.7L V8 5663cc 345 CID	2006-2008	INFINITI FX45	4.5L V8 4494cc		
	2008-2011	LEXUS LX570	5.7L V8 5663cc 345 CID	2006-2010	INFINITI M45	4.5L V8 4494cc		
	2008-2011	TOYOTA LAND CRUISER	5.7L V8 5663cc 345 CID	<b>US6228</b>	2003	MITSUBISHI OUTLANDER	2.4L L4 2351cc	
	2008-2017	TOYOTA SEQUOIA	5.7L V8 5663cc 345 CID		1998-2004	MERCEDES-BENZ SLK230	2.3L L4 2295cc	
	2013-2017	LEXUS LX570	5.7L V8 5663cc 345 CID	2002	MERCEDES-BENZ C230	2.3L L4 2295cc		
	2013-2017	TOYOTA LAND CRUISER	5.7L V8 5663cc 345 CID	<b>US6231</b>	2008	CHRYSLER TOWN & COUNTRY	3.8L V6 230 CID	
<b>US6198</b>	2007	INFINITI G35	3.5L V6 3498cc		2008	DODGE GRAND CARAVAN	3.8L V6 230 CID	
	2007	NISSAN MURANO	3.5L V6 3498cc		2008-2010	CHRYSLER TOWN & COUNTRY	3.3L V6 3301cc 201 CID	
2007-2008	INFINITI FX35	3.5L V6 3498cc	2008-2010		DODGE GRAND CARAVAN	3.3L V6 3301cc 201 CID		
2007-2008	INFINITI M35	3.5L V6 3498cc	2009-2010		CHRYSLER TOWN & COUNTRY	3.8L V6 3778cc 231 CID		
2007-2017	NISSAN ALTIMA	3.5L V6 3498cc	2009-2010		DODGE GRAND CARAVAN	3.8L V6 3778cc 231 CID		
2009-2014	NISSAN MAXIMA	3.5L V6 3498cc	2009-2010		VOLKSWAGEN ROUTAN	3.8L V6 3778cc 231 CID		
2009-2017	NISSAN MURANO	3.5L V6 3498cc	2010		CHRYSLER TOWN & COUNTRY	3.8L V6 3800cc 231 CID		
2011-2012	INFINITI G25	2.5L V6 2496cc 152 CID	2010		VOLKSWAGEN ROUTAN	3.8L V6 3778cc 230 CID		
2011-2017	NISSAN QUEST	3.5L V6 3498cc	<b>US6232</b>		2008-2014	SCION XD	1.8L L4 1798cc	
2013	INFINITI JX35	3.5L V6 3498cc						



USMW	Years	Application	Engine	USMW	Years	Application	Engine	
<b>US6232</b>	2009-2010	PONTIAC VIBE	1.8L L4 1798cc	<b>US6287</b>	2002-2004	INFINITI Q45	4.5L V8 4494cc	
	2009-2013	TOYOTA MATRIX	1.8L L4 1798cc		2003-2004	INFINITI M45	4.5L V8 4500cc	
	2009-2017	TOYOTA COROLLA	1.8L L4 1798cc	<b>US6292</b>	2009-2013	SUZUKI GRAND VITARA	2.4L L4 2393cc	
<b>US6233</b>	2008-2012	HONDA ACCORD	2.4L L4 2354cc 144 CID		2010-2013	SUZUKI KIZASHI	2.4L L4 2388cc 146 CID	
	2009-2014	ACURA TSX	2.4L L4 2354cc 144 CID		2010-2013	SUZUKI SX4	2.0L L4 1995cc	
2010-2011	HONDA CR-V	2.4L L4 2354cc 144 CID	<b>US6295</b>		2010-2015	SUZUKI GRAND VITARA	2.4L L4 2393cc 146 CID	
<b>US6235</b>	2007-2009	MERCEDES-BENZ CLK550		5.5L V8 5461cc	2011-2014	MAZDA 2	1.5L L4 1498cc 91 CID	
	2007-2009	MERCEDES-BENZ SL550	5.5L V8 5461cc	<b>US6336</b>	2010-2012	TOYOTA SEQUOIA	4.6L V8 4608cc	
	2007-2010	MERCEDES-BENZ CL550	5.5L V8 5461cc		2010-2017	LEXUS GX460	4.6L V8 4608cc	
	2007-2011	MERCEDES-BENZ CLS550	5.5L V8 5461cc	2010-2017	TOYOTA TUNDRA	4.6L V8 4608cc		
	2007-2011	MERCEDES-BENZ E550	5.5L V8 5461cc	<b>US6338</b>	2007-2017	LEXUS LS460	4.6L V8 4608cc	
	2007-2011	MERCEDES-BENZ S550	5.5L V8 5461cc		2008-2011	LEXUS GS460	4.6L V8 4608cc	
	2007-2012	MERCEDES-BENZ GL450	4.6L V8 4663cc		2008-2014	LEXUS IS F	5.0L V8 4969cc 303 CID	
	2008-2011	MERCEDES-BENZ ML550	5.5L V8 5461cc		2008-2016	LEXUS LS600H	5.0L V8 4968cc	
	2008-2012	MERCEDES-BENZ GL550	5.5L V8 5461cc		2015-2017	LEXUS RC F	5.0L V8 4969cc 303 CID	
	2009-2015	MERCEDES-BENZ G550	5.5L V8 5461cc	2016-2017	LEXUS GS F	5.0L V8 4969cc 303 CID		
	2011-2012	MERCEDES-BENZ SL550	5.5L V8 5461cc	<b>US6341</b>	2009	CHRYSLER ASPEN	5.7L V8 345 CID	
<b>US6238</b>	2006-2008	BMW 750I	4.8L V8 4837cc		2009	DODGE DURANGO	5.7L V8 345 CID	
	2006-2008	BMW 750LI	4.8L V8 4837cc		2009	DODGE RAM 3500	5.7L V8 345 CID	
	2006-2010	BMW 550I	4.8L V8 4837cc		2009-2010	DODGE RAM 1500	5.7L V8 345 CID	
	2006-2010	BMW 650I	4.8L V8 4837cc		2009-2010	DODGE RAM 2500	5.7L V8 345 CID	
2007-2010	BMW X5	4.8L V8 4837cc	2010		DODGE RAM 4000	5.7L V8 5700cc 350 CID		
<b>US6240</b>	2007-2011	MITSUBISHI OUTLANDER	3.0L V6 2998cc 182 CID		2011-2018	RAM 1500	5.7L V8 345 CID	
<b>US6241</b>	2004-2006	SUZUKI VERONA	2.5L L6 2492cc		2011-2018	RAM 2500	5.7L V8 345 CID	
<b>US6242</b>	2005-2017	NISSAN FRONTIER	2.5L L4 2488cc 152 CID		2011-2018	RAM 3500	5.7L V8 345 CID	
	2006	NISSAN FRONTIER	2.4L L4 2389cc 146 CID		2015-2016	DODGE RAM 2500	5.7L V8 5654cc 345 CID	
	2008	NISSAN URVAN	2.5L L4 2500cc 153 CID	<b>US6349</b>	2009	MERCEDES-BENZ R320	3.0L V6 2987cc	
	2008-2013	NISSAN URVAN	2.5L L4 2488cc 152 CID		<b>US6350</b>	2009-2013	HONDA FIT	1.5L L4 1497cc
2011-2013	NISSAN URVAN	2.5L L4 2500cc 153 CID	2010-2014	HONDA CITY		1.5L L4 1496cc 91 CID		
2010-2015	MINI COOPER	1.6L L4 1598cc	2010-2014	HONDA FIT		1.5L L4 1496cc 91 CID		
<b>US6244</b>	2011-2015	MINI COOPER	1.6L L4 1598cc 98 CID	2011-2014	HONDA FIT	1.5L H4 1496cc 91 CID		
	2011-2016	MINI COOPER COUNTRYMAN	1.6L L4 1598cc	<b>US6599</b>	2010-2014	TOYOTA FJ CRUISER	4.0L V6 3956cc 241 CID	
	2013-2016	MINI COOPER PACEMAN	1.6L L4 1598cc		2010-2017	TOYOTA 4RUNNER	4.0L V6 3956cc 241 CID	
	2014-2016	MINI COOPER COUNTRYMAN	1.6L L4 1598cc 98 CID		2011-2014	TOYOTA TUNDRA	4.0L V6 3956cc 241 CID	
<b>US6247</b>	2010-2017	KIA SOUL	1.6L L4 1591cc	<b>US6654</b>	2011-2014	FORD F-150	3.7L V6 3726cc 227 CID	
	2012-2017	HYUNDAI ACCENT	1.6L L4 1591cc 97 CID		2011-2014	FORD F-150	3.7L V6 3727cc 227 CID	
	2012-2017	HYUNDAI VELOSTER	1.6L L4 1591cc 97 CID	2011-2015	FORD MUSTANG	3.7L V6 3726cc 227 CID		
	2012-2017	KIA RIO	1.6L L4 1591cc 97 CID	2012	FORD MUSTANG	3.7L V6 3700cc 227 CID		
	2014-2016	KIA FORTE KOUP	1.6L L4 1591cc 97 CID	2014	FORD MUSTANG	3.7L V6 3700cc 227 CID		
	2014-2017	KIA FORTE5	1.6L L4 1591cc 97 CID	2015	FORD F-150	3.5L V6 3496cc 213 CID		
	2015-2017	HYUNDAI SONATA	1.6L L4 1591cc 97 CID	2015	FORD TRANSIT-150	3.7L V6 3726cc 227 CID		
	2016-2017	HYUNDAI TUCSON	1.6L L4 1591cc 97 CID	2015	FORD TRANSIT-250	3.7L V6 3726cc 227 CID		
	2016-2017	KIA OPTIMA	1.6L L4 1591cc 97 CID	2015	FORD TRANSIT-350	3.7L V6 3726cc 227 CID		
	2017	HYUNDAI ELANTRA	1.6L L4 1591cc 97 CID	2015	FORD TRANSIT-350 HD	3.7L V6 3726cc 227 CID		
	<b>US6249</b>	2008-2010	AUDI A5 QUATTRO	3.2L V6 3123cc	<b>US6657</b>	2002-2005	JAGUAR X-TYPE	2.5L V6 152 CID
2009		AUDI A4 QUATTRO	3.2L V6 3123cc	2002-2008		JAGUAR X-TYPE	3.0L V6 2968cc 181 CID	
2009-2012		AUDI Q5	3.2L V6 3123cc	<b>US6662</b>	2011-2015	CHEVROLET CRUZE	1.4L L4 1364cc 83 CID	
2010-2011		AUDI A6	3.2L V6 3123cc		2012-2017	CHEVROLET SONIC	1.4L L4 1364cc 83 CID	
2010-2012		AUDI Q5	3.2L V6 3200cc 195 CID		2013-2017	BUICK ENCORE	1.4L L4 1364cc 83 CID	
2014-2017	HYUNDAI ELANTRA	1.6L L4 1591cc 97 CID	2014-2017		CHEVROLET TRAX	1.4L L4 1364cc 83 CID		
<b>US6250</b>	2009-2011	MAZDA TRIBUTE	3.0L V6 2968cc 181 CID	2016	CHEVROLET CRUZE LIMITED	1.4L L4 1364cc 83 CID		
	2009-2011	MERCURY MARINER	3.0L V6 2968cc 181 CID	<b>US6680</b>	2007-2008	BMW 328XI	3.0L L6 2996cc	
	2009-2012	FORD ESCAPE	3.0L V6 2968cc 181 CID		2007-2010	BMW X3	3.0L L6 2996cc	
	2010-2011	MERCURY MILAN	3.0L V6 2968cc 181 CID		2007-2010	BMW X5	3.0L L6 2996cc	
	2010-2012	FORD FUSION	3.0L V6 2968cc 181 CID		2007-2013	BMW 328I	3.0L L6 2996cc	
	2011-2012	FORD ESCAPE	3.0L V6 2967cc 181 CID		2008	BMW 528XI	3.0L L6 2996cc	
	2011-2012	FORD FUSION	3.0L V6 2967cc 181 CID		2008-2010	BMW 528I	3.0L L6 2996cc	
	<b>US6251</b>	2005-2007	LAND ROVER LR3		4.0L V6 4009cc 245 CID	2008-2011	BMW Z4	3.0L L6 2996cc
		<b>US6252</b>	2009-2015		TOYOTA VENZA	2.7L L4 2672cc 163 CID	2008-2013	BMW 128I
	2009-2017		TOYOTA HIGHLANDER		2.7L L4 2672cc 163 CID	2009-2010	BMW 528I XDRIVE	3.0L L6 2996cc
2009-2017	TOYOTA RAV4		2.5L L4 2494cc 152 CID		2009-2013	BMW 328I XDRIVE	3.0L L6 2996cc	
2010-2017	TOYOTA CAMRY		2.5L L4 2494cc 152 CID	2010	BMW X3	3.0L L6 2996cc 183 CID		
2011-2012	TOYOTA SIENNA		2.7L L4 2672cc 163 CID	<b>US6681</b>	2007-2008	BMW 335XI	3.0L L6 2979cc	
2011-2016	SCION TC		2.5L L4 2494cc 152 CID		2007-2013	BMW 335I	3.0L L6 2979cc	
<b>US6273</b>	2001-2002		MERCEDES-BENZ CL600		5.8L V12 5786cc	2008	BMW 535XI	3.0L L6 2979cc
	2001-2002	MERCEDES-BENZ S600	5.8L V12 5786cc		2008-2013	BMW 135I	3.0L L6 2979cc	
	2003-2013	MERCEDES-BENZ S600	5.5L V12 5513cc 336 CID		2008-2014	BMW X6	3.0L L6 2979cc	
	2003-2014	MERCEDES-BENZ CL600	5.5L V12 5513cc 336 CID		2008-2016	BMW 535I	3.0L L6 2979cc	
	2004-2009	MERCEDES-BENZ SL600	5.5L V12 5513cc 336 CID		2009-2013	BMW 335I XDRIVE	3.0L L6 2979cc	
	2005-2006	MERCEDES-BENZ CL65 AMG	6.0L V12 5980cc 365 CID		2009-2016	BMW 535I XDRIVE	3.0L L6 2979cc	
	2005-2011	MERCEDES-BENZ SL65 AMG	6.0L V12 5980cc 365 CID		2009-2016	BMW Z4	3.0L L6 2979cc	
	2006-2013	MERCEDES-BENZ S65 AMG	6.0L V12 5980cc 365 CID		2010-2017	BMW 535I GT	3.0L L6 2979cc	
	2008-2014	MERCEDES-BENZ CL65 AMG	6.0L V12 5980cc 365 CID		2011	BMW 1 SERIES M	3.0L L6 2979cc	
	2013-2017	MERCEDES-BENZ SL65 AMG	6.0L V12 5980cc 365 CID		2011-2013	BMW 335IS	3.0L L6 2979cc	
	2015-2017	MERCEDES-BENZ S65 AMG	6.0L V12 5980cc 365 CID		2011-2013	BMW X5	3.0L L6 2979cc	
	2015-2017	MERCEDES-BENZ S600	6.0L V12 5980cc 365 CID		2011-2013	BMW Z4	3.0L L6 2979cc 182 CID	
	2016-2017	MERCEDES-BENZ G65 AMG	6.0L V12 5980cc 365 CID		2011-2015	BMW 740I	3.0L L6 2979cc	
	2016-2017	MERCEDES-BENZ MAYBACH S600	6.0L V12 5980cc 365 CID	2011-2015	BMW 740LI	3.0L L6 2979cc		
	<b>US6276</b>	2005-2011	VOLVO XC90	4.4L V8 4414cc 269 CID	2011-2017	BMW 535I GT XDRIVE	3.0L L6 2979cc	
2007-2010		VOLVO S80	4.4L V8 4414cc 269 CID	2011-2017	BMW X3	3.0L L6 2979cc		

USMW	Years	Application	Engine	USMW	Years	Application	Engine	
<b>US6681</b>	2014	<b>BMW X3</b>	3.0L L6 2979cc 182 CID	<b>US7100</b>	1975-1980	<b>DODGE W200</b>	3.7L L6 3687cc 225 CID	
	2014-2017	<b>BMW 640I XDRIVE</b>	3.0L L6 2979cc		1975-1980	<b>PLYMOUTH PB100</b>	3.7L L6 3687cc 225 CID	
	2014-2017	<b>BMW 640I XDRIVE GRAN COUPE</b>	3.0L L6 2979cc		1975-1980	<b>PLYMOUTH TRAILDUSTER</b>	3.7L L6 3687cc 225 CID	
	2015-2017	<b>BMW X4</b>	3.0L L6 2979cc		1976	<b>DODGE CHARGER</b>	3.7L L6 3687cc 225 CID	
<b>US6682</b>	2016	<b>BMW 640I GRAN COUPE</b>	3.0L L6 2979cc 182 CID	1976-1980	<b>DODGE ASPEN</b>	3.7L L6 3687cc 225 CID		
	2010-2015	<b>TOYOTA PRIUS</b>	1.8L L4 1798cc 110 CID	1976-1980	<b>PLYMOUTH VOLARE</b>	3.7L L6 3687cc 225 CID		
	2011-2017	<b>LEXUS CT200H</b>	1.8L L4 1798cc 110 CID	1977-1978	<b>DODGE MONACO</b>	3.7L L6 3687cc 225 CID		
	2012-2015	<b>TOYOTA PRIUS PLUG-IN</b>	1.8L L4 1798cc 110 CID	1977-1982	<b>DODGE DART</b>	3.7L L6 3700cc 225 CID		
	2012-2017	<b>TOYOTA PRIUS C</b>	1.5L L4 1497cc 91 CID	1977-1987	<b>DODGE D150</b>	3.7L L6 3687cc 225 CID		
<b>US6687</b>	2012-2017	<b>TOYOTA PRIUS V</b>	1.8L L4 1798cc 110 CID	1978-1979	<b>DODGE D300</b>	3.7L L6 3700cc 225 CID		
	2009-2011	<b>NISSAN VERSA</b>	1.6L L4 1598cc	1978-1981	<b>CHRYSLER LEBARON</b>	3.7L L6 3687cc 225 CID		
	2014-2016	<b>NISSAN MARCH</b>	1.6L L4 1598cc 98 CID	1978-1981	<b>CHRYSLER TOWN &amp; COUNTRY</b>	3.7L L6 3687cc 225 CID		
<b>US6689</b>	2014-2017	<b>NISSAN VERSA</b>	1.6L L4 1598cc	1978-1983	<b>DODGE DIPLOMAT</b>	3.7L L6 3687cc 225 CID		
	2014-2017	<b>NISSAN VERSA NOTE</b>	1.6L L4 1598cc	1978-1987	<b>DODGE W150</b>	3.7L L6 3687cc 225 CID		
	2010-2015	<b>CHEVROLET CAMARO</b>	6.2L V8 6162cc 376 CID	1979	<b>DODGE B200</b>	3.7L L6 225 CID		
<b>US6692</b>	2008-2014	<b>SUBARU TRIBECA</b>	3.6L H6 3630cc	1979-1981	<b>DODGE ST. REGIS</b>	3.7L L6 3687cc 225 CID		
	2010-2015	<b>SUBARU LEGACY</b>	3.6L H6 3630cc	1980	<b>DODGE B200</b>	3.7L L6 3687cc 225 CID		
<b>US6693</b>	2010-2015	<b>SUBARU OUTBACK</b>	3.6L H6 3630cc	1980	<b>DODGE B300</b>	3.7L L6 225 CID		
	2012-2015	<b>HONDA CIVIC</b>	1.8L L4 1799cc	1980	<b>DODGE D150</b>	3.7L L6 3700cc 225 CID		
	2014-2015	<b>HONDA CIVIC</b>	1.8L L4 1799cc 110 CID	1980	<b>PLYMOUTH PB200</b>	3.7L L6 3687cc 225 CID		
<b>US6699</b>	2012	<b>JEEP WRANGLER</b>	3.6L L6 3604cc 220 CID	1980-1981	<b>CHRYSLER NEWPORT</b>	3.7L L6 3687cc 225 CID		
	2012-2017	<b>JEEP WRANGLER</b>	3.6L V6 3604cc 220 CID	1980-1983	<b>CHRYSLER CORDOBA</b>	3.7L L6 3687cc 225 CID		
<b>US6700</b>	2012-2017	<b>MAZDA 3</b>	2.0L L4 1998cc 122 CID	1980-1983	<b>DODGE MIRADA</b>	3.7L L6 3687cc 225 CID		
	2013-2016	<b>MAZDA CX-5</b>	2.0L L4 1998cc 122 CID	1980-1983	<b>PLYMOUTH GRAN FURY</b>	3.7L L6 3687cc 225 CID		
	2014-2017	<b>MAZDA 3</b>	2.5L L4 2488cc 152 CID	1980-1987	<b>DODGE D350</b>	3.7L L6 3700cc 225 CID		
	2014-2017	<b>MAZDA 6</b>	2.5L L4 2488cc 152 CID	1981	<b>PLYMOUTH VALIANT</b>	3.7L L6 3700cc 225 CID		
	2014-2017	<b>MAZDA CX-5</b>	2.5L L4 2488cc 152 CID	1981-1983	<b>PLYMOUTH PB150</b>	3.7L L6 3687cc 225 CID		
	2016	<b>SCION IA</b>	1.5L L4 1496cc 91 CID	1981-1983	<b>PLYMOUTH PB250</b>	3.7L L6 3687cc 225 CID		
	2016-2017	<b>MAZDA CX-3</b>	2.0L L4 1998cc 122 CID	1981-1987	<b>DODGE B150</b>	3.7L L6 3687cc 225 CID		
	2017	<b>TOYOTA YARIS IA</b>	1.5L L4 1496cc 91 CID	1981-1987	<b>DODGE B250</b>	3.7L L6 3687cc 225 CID		
	<b>US6702</b>	2007-2008	<b>AUDI RS4</b>	4.2L V8 4172cc	1981-1987	<b>DODGE D250</b>	3.7L L6 3687cc 225 CID	
2007-2009		<b>AUDI S8</b>	5.2L V10 5204cc	1982	<b>CHRYSLER NEW YORKER</b>	3.7L L6 3687cc 225 CID		
2007-2009		<b>VOLKSWAGEN TOUAREG</b>	4.2L V8 4163cc	1982	<b>PLYMOUTH VOLARE</b>	3.7L L6 3700cc 225 CID		
2007-2010		<b>AUDI Q7</b>	4.2L V8 4163cc	1983	<b>CHRYSLER FIFTH AVENUE</b>	3.7L L6 3687cc 225 CID		
2007-2011		<b>AUDI A6 QUATTRO</b>	4.2L V8 4163cc	1985-1987	<b>DODGE D100</b>	3.7L L6 3687cc 225 CID		
2007-2011		<b>AUDI S6</b>	5.2L V10 5204cc	1985-1987	<b>DODGE W250</b>	3.7L L6 3700cc 225 CID		
2007-2012		<b>AUDI A8 QUATTRO</b>	4.2L V8 4163cc	1986-1987	<b>DODGE W100</b>	3.7L L6 3687cc 225 CID		
2008-2012		<b>AUDI S5</b>	4.2L V8 4163cc	1986-1989	<b>CHRYSLER VOLARE</b>	3.7L L6 3700cc 225 CID		
2012		<b>AUDI A8</b>	4.2L V8 4163cc 254 CID	1988-1990	<b>DODGE D150</b>	3.7L L6 3700cc 225 CID		
2013-2015		<b>AUDI RS5</b>	4.2L V8 4163cc 254 CID	1989-1990	<b>DODGE D350</b>	3.7L L6 3700cc 225 CID		
2014-2015		<b>AUDI R8</b>	4.2L V8 4163cc	1978-1983	<b>DODGE OMNI</b>	1.7L L4 105 CID		
2014-2015		<b>AUDI R8</b>	4.2L V8 4163cc 254 CID	1978-1983	<b>PLYMOUTH HORIZON</b>	1.7L L4 105 CID		
2002-2006		<b>ACURA RSX</b>	2.0L L4 1998cc 122 CID	1980-1982	<b>PLYMOUTH TC3</b>	1.7L L4 105 CID		
<b>US6703</b>		2008-2017	<b>BMW X6</b>	4.4L V8 4395cc	1983	<b>PLYMOUTH TURISMO</b>	1.7L L4 105 CID	
		2009-2015	<b>BMW 750LI</b>	4.4L V8 4395cc	<b>US7104</b>	1979	<b>PLYMOUTH COLT</b>	1.6L L4 1597cc 98 CID
		2009-2016	<b>BMW 750I</b>	4.4L V8 4395cc		1979-1980	<b>DODGE COLT</b>	1.6L L4 1597cc 98 CID
		2010-2015	<b>BMW 550I GT</b>	4.4L V8 4395cc	1979-1980	<b>PLYMOUTH CHAMP</b>	1.6L L4 1597cc 98 CID	
	2010-2015	<b>BMW 750LI XDRIVE</b>	4.4L V8 4395cc	<b>US7105</b>	1978	<b>DODGE COLT</b>	1.6L L4 1597cc 98 CID	
	2010-2016	<b>BMW 750I XDRIVE</b>	4.4L V8 4395cc		1978	<b>PLYMOUTH COLT</b>	1.6L L4 1597cc 98 CID	
	2010-2017	<b>BMW 550I GT XDRIVE</b>	4.4L V8 4395cc	1978-1979	<b>DODGE CHALLENGER</b>	1.6L L4 1597cc 98 CID		
	2010-2017	<b>BMW X5</b>	4.4L V8 4395cc	1978-1979	<b>PLYMOUTH SAPPORO</b>	1.6L L4 1597cc 98 CID		
	2011-2015	<b>BMW ALPINA B7</b>	4.4L V8 4395cc	1978-1980	<b>PLYMOUTH ARROW</b>	1.6L L4 1597cc 98 CID		
	2011-2015	<b>BMW ALPINA B7L</b>	4.4L V8 4395cc	<b>US7106</b>	1979	<b>PLYMOUTH COLT</b>	1.4L L4 1410cc	
	2011-2015	<b>BMW ALPINA B7L XDRIVE</b>	4.4L V8 4395cc		1979-1980	<b>DODGE COLT</b>	1.4L L4 1410cc	
	2011-2015	<b>BMW ALPINA B7 XDRIVE</b>	4.4L V8 4395cc		1979-1980	<b>PLYMOUTH CHAMP</b>	1.4L L4 1410cc	
	2011-2016	<b>BMW 550I</b>	4.4L V8 4395cc		<b>US7108</b>	1981-1982	<b>PLYMOUTH CHAMP</b>	1.6L L4 1597cc 98 CID
	2011-2016	<b>BMW 550I XDRIVE</b>	4.4L V8 4395cc	1981-1988		<b>DODGE COLT</b>	1.6L L4 1597cc 98 CID	
	2012-2017	<b>BMW 650I</b>	4.4L V8 4395cc	1983-1988		<b>PLYMOUTH COLT</b>	1.6L L4 1597cc 98 CID	
	2012-2017	<b>BMW 650I XDRIVE</b>	4.4L V8 4395cc	1985-1988		<b>MITSUBISHI MIRAGE</b>	1.6L L4 1597cc 98 CID	
	2013-2017	<b>BMW 650I GRAN COUPE</b>	4.4L V8 4395cc	1989-1990		<b>DODGE COLT</b>	1.8L L4 1754cc 107 CID	
	2013-2017	<b>BMW 650I XDRIVE GRAN COUPE</b>	4.4L V8 4395cc	1989-1990		<b>PLYMOUTH COLT</b>	1.8L L4 1754cc 107 CID	
	2014	<b>BMW X5</b>	4.4L V8 4395cc 268 CID	1990-1994		<b>MITSUBISHI ECLIPSE</b>	1.8L L4 1755cc 107 CID	
	2014	<b>BMW X6</b>	4.4L V8 4395cc 268 CID	1990-1994		<b>PLYMOUTH LASER</b>	1.8L L4 1755cc 107 CID	
	2014-2015	<b>BMW 650I</b>	4.4L V8 4395cc 268 CID	1993-1994		<b>EAGLE TALON</b>	1.8L L4 1755cc 107 CID	
	2014-2015	<b>BMW 750I</b>	4.4L V8 4395cc 268 CID	<b>US7110</b>		1981-1982	<b>PLYMOUTH TC3</b>	2.2L L4 135 CID
	2014-2015	<b>BMW 750LI</b>	4.4L V8 4395cc 268 CID		1981-1988	<b>DODGE ARIES</b>	2.2L L4 135 CID	
	2015-2016	<b>BMW 650I GRAN COUPE</b>	4.4L V8 4395cc 268 CID		1981-1988	<b>DODGE OMNI</b>	2.2L L4 135 CID	
	2015-2017	<b>BMW ALPINA B6 XDRIVE GRAN COUPE</b>	4.4L V8 4395cc		1981-1988	<b>PLYMOUTH HORIZON</b>	2.2L L4 135 CID	
	<b>US7100</b>	1965-1970	<b>DODGE CORONET</b>		3.7L L6 3700cc 225 CID	1981-1988	<b>PLYMOUTH RELIANT</b>	2.2L L4 135 CID
		1965-1974	<b>DODGE DART</b>		3.7L L6 3700cc 225 CID	1982-1983	<b>DODGE 400</b>	2.2L L4 135 CID
1967-1968		<b>DODGE D300</b>	3.7L L6 3700cc 225 CID		1982-1984	<b>DODGE RAMPAGE</b>	2.2L L4 135 CID	
1970-1974		<b>DODGE D100</b>	3.7L L6 3700cc 225 CID		1982-1987	<b>CHRYSLER LEBARON</b>	2.2L L4 2200cc 135 CID	
1974-1976		<b>PLYMOUTH VALIANT</b>	3.7L L6 3700cc 225 CID		1982-1988	<b>CHRYSLER LEBARON</b>	2.2L L4 135 CID	
1975-1976		<b>DODGE CORONET</b>	3.7L L6 3687cc 225 CID		1982-1988	<b>CHRYSLER TOWN &amp; COUNTRY</b>	2.2L L4 135 CID	
1975-1976		<b>PLYMOUTH DUSTER</b>	3.7L L6 3687cc 225 CID		1982-1988	<b>DODGE DART</b>	2.2L L4 2200cc 135 CID	
1975-1976		<b>PLYMOUTH SCAMP</b>	3.7L L6 3687cc 225 CID		1982-1988	<b>PLYMOUTH VOLARE</b>	2.2L L4 2200cc 135 CID	
1975-1976		<b>PLYMOUTH VALIANT</b>	3.7L L6 3687cc 225 CID		1983	<b>PLYMOUTH SCAMP</b>	2.2L L4 135 CID	
1975-1977		<b>DODGE DART</b>	3.7L L6 3687cc 225 CID		1983-1984	<b>CHRYSLER E CLASS</b>	2.2L L4 135 CID	
1975-1977		<b>DODGE W100</b>	3.7L L6 3687cc 225 CID		1983-1984	<b>PLYMOUTH TURISMO</b>	2.2L L4 135 CID	
1975-1978		<b>DODGE B200</b>	3.7L L6 3687cc 225 CID		1983-1986	<b>PLYMOUTH TURISMO 2.2</b>	2.2L L4 135 CID	
1975-1978		<b>DODGE D300</b>	3.7L L6 3687cc 225 CID	1983-1988	<b>CHRYSLER NEW YORKER</b>	2.2L L4 135 CID		
1975-1978		<b>DODGE W300</b>	3.7L L6 3687cc 225 CID	1983-1988	<b>DODGE 600</b>	2.2L L4 135 CID		
1975-1978		<b>PLYMOUTH FURY</b>	3.7L L6 3687cc 225 CID	1983-1988	<b>DODGE MAGNUM</b>	2.2L L4 2200cc 135 CID		
1975-1978		<b>PLYMOUTH PB200</b>	3.7L L6 3687cc 225 CID	1984-1986	<b>CHRYSLER LASER</b>	2.2L L4 135 CID		
1975-1979		<b>DODGE B300</b>	3.7L L6 3687cc 225 CID	1984-1987	<b>DODGE CARAVAN</b>	2.2L L4 135 CID		
1975-1979		<b>DODGE D100</b>	3.7L L6 3687cc 225 CID	1984-1987	<b>DODGE CHARGER</b>	2.2L L4 135 CID		
1975-1980		<b>DODGE B100</b>	3.7L L6 3687cc 225 CID	1984-1987	<b>DODGE MINI RAM</b>	2.2L L4 135 CID		
1975-1980		<b>DODGE D200</b>	3.7L L6 3687cc 225 CID	1984-1987	<b>PLYMOUTH VOYAGER</b>	2.2L L4 135 CID		
1975-1980		<b>DODGE RAMCHARGER</b>	3.7L L6 3687cc 225 CID	1984-1988	<b>DODGE DAYTONA</b>	2.2L L4 135 CID		

USMW	Years	Application	Engine	USMW	Years	Application	Engine
<b>US7110</b>	1985-1988	<b>DODGE</b> LANCER	2.2L L4 135 CID	<b>US7111</b>	1985	<b>CHRYSLER</b> EXECUTIVE LIMOUSINE	2.6L L4 2555cc 156 CID
	1985-1988	<b>PLYMOUTH</b> CARAVELLE	2.2L L4 135 CID		1985	<b>PLYMOUTH</b> CARAVELLE	2.6L L4 2555cc 156 CID
	1985-1991	<b>CHRYSLER</b> NEW YORKER	2.2L L4 2200cc 135 CID	<b>US7113</b>	1983-1984	<b>PLYMOUTH</b> TURISMO	1.6L L4 1595cc 97 CID
	1986	<b>CHRYSLER</b> LASER	2.5L L4 2507cc 153 CID		1983-1986	<b>DODGE</b> OMNI	1.6L L4 1595cc 97 CID
	1986-1987	<b>CHRYSLER</b> NEW YORKER	2.5L L4 2507cc 153 CID	1983-1986	<b>PLYMOUTH</b> HORIZON	1.6L L4 1595cc 97 CID	
	1986-1987	<b>PLYMOUTH</b> TURISMO	2.2L L4 135 CID	1984	<b>DODGE</b> CHARGER	1.6L L4 1595cc 97 CID	
	1986-1988	<b>CHRYSLER</b> DART	2.2L L4 2200cc 135 CID	1986	<b>PLYMOUTH</b> TURISMO	1.6L L4 1595cc 97 CID	
	1986-1988	<b>CHRYSLER</b> LEBARON	2.5L L4 2507cc 153 CID	<b>US7114</b>	1983	<b>DODGE</b> POWER RAM 50	2.0L L4 1997cc
	1986-1988	<b>CHRYSLER</b> TOWN & COUNTRY	2.5L L4 2507cc 153 CID		1983	<b>DODGE</b> POWER RAM 50	2.6L L4 2555cc
	1986-1988	<b>DODGE</b> 600	2.5L L4 2507cc 153 CID	1983	<b>DODGE</b> RAM 50	2.0L L4 1997cc 122 CID	
	1986-1988	<b>DODGE</b> ARIES	2.5L L4 2507cc 153 CID	1983	<b>DODGE</b> RAM 50	2.6L L4 2555cc 156 CID	
	1986-1988	<b>DODGE</b> DAYTONA	2.5L L4 2507cc 153 CID	1983-1989	<b>MITSUBISHI</b> MIGHTY MAX	2.0L L4 1997cc 122 CID	
	1986-1988	<b>DODGE</b> LANCER	2.5L L4 2507cc 153 CID	1984	<b>DODGE</b> POWER RAM 50	2.0L L4 1995cc	
	1986-1988	<b>PLYMOUTH</b> CARAVELLE	2.5L L4 2507cc 153 CID	1984-1989	<b>DODGE</b> RAM 50	2.0L L4 1995cc 122 CID	
	1986-1988	<b>PLYMOUTH</b> RELIANT	2.5L L4 2507cc 153 CID	1985	<b>DODGE</b> RAM 50	2.6L L4 2555cc 156 CID	
	1987-1988	<b>CHRYSLER</b> MAGNUM	2.5L L4 2507cc 153 CID	1987-1990	<b>MITSUBISHI</b> VAN	2.4L L4 2351cc	
	1987-1988	<b>DODGE</b> DAKOTA	2.2L L4 135 CID	1990-1993	<b>DODGE</b> RAM 50	2.4L L4 2351cc	
	1987-1988	<b>DODGE</b> SHADOW	2.2L L4 135 CID	1990-1996	<b>MITSUBISHI</b> MIGHTY MAX	2.4L L4 2351cc	
	1987-1988	<b>PLYMOUTH</b> SUNDANCE	2.2L L4 135 CID	2003-2005	<b>DODGE</b> H-100	2.4L L4 2351cc 144 CID	
	1987-1988	<b>PLYMOUTH</b> VOYAGER	2.5L L4 2507cc 153 CID	<b>US7115</b>	1981-1982	<b>PLYMOUTH</b> CHAMP	1.4L L4 1410cc
	1987-1990	<b>CHRYSLER</b> PHANTOM	2.2L L4 2200cc 135 CID		1981-1984	<b>DODGE</b> COLT	1.4L L4 1410cc
	1988	<b>CHRYSLER</b> SHADOW	2.5L L4 2507cc 153 CID	1983-1984	<b>PLYMOUTH</b> COLT	1.4L L4 1410cc	
	1988	<b>DODGE</b> CARAVAN	2.5L L4 2507cc 153 CID	1984	<b>DODGE</b> CONQUEST	2.6L L4 2555cc 156 CID	
	1988	<b>DODGE</b> DYNASTY	2.5L L4 2507cc 153 CID	1984	<b>PLYMOUTH</b> CONQUEST	2.6L L4 2555cc 156 CID	
	1988	<b>DODGE</b> GRAND CARAVAN	2.5L L4 2507cc 153 CID	1985-1994	<b>DODGE</b> COLT	1.5L L4 1468cc 90 CID	
	1988	<b>DODGE</b> SHADOW	2.2L L4 2200cc 135 CID	1985-1994	<b>PLYMOUTH</b> COLT	1.5L L4 1468cc 90 CID	
	1988	<b>DODGE</b> SHADOW	2.5L L4 2507cc 153 CID	1985-1996	<b>MITSUBISHI</b> MIRAGE	1.5L L4 1468cc 90 CID	
	1988	<b>PLYMOUTH</b> GRAND VOYAGER	2.5L L4 2507cc 153 CID	1986-1994	<b>HYUNDAI</b> EXCEL	1.5L L4 1468cc	
	1988	<b>PLYMOUTH</b> SUNDANCE	2.5L L4 2507cc 153 CID	1987-1994	<b>MITSUBISHI</b> PRECIS	1.5L L4 1468cc	
	1990	<b>CHRYSLER</b> TC MASERATI	2.2L L4 135 CID	1989-1996	<b>EAGLE</b> SUMMIT	1.5L L4 1468cc 90 CID	
	1992-1994	<b>CHRYSLER</b> PHANTOM	2.2L L4 2200cc 135 CID	1991-1992	<b>HYUNDAI</b> SCOUPE	1.5L L4 1468cc	
	<b>US7110H</b>	1981-1982	<b>PLYMOUTH</b> TC3	2.2L L4 135 CID	1993-1995	<b>HYUNDAI</b> SCOUPE	1.5L L4 1495cc
		1981-1988	<b>DODGE</b> ARIES	2.2L L4 135 CID	1995-2001	<b>HYUNDAI</b> ACCENT	1.5L L4 1495cc
		1981-1988	<b>DODGE</b> OMNI	2.2L L4 135 CID	2004-2006	<b>DODGE</b> VERNA	1.5L L4 1508cc 92 CID
1981-1988		<b>PLYMOUTH</b> HORIZON	2.2L L4 135 CID	2006-2010	<b>DODGE</b> ATTITUDE	1.4L L4 1388cc 85 CID	
1981-1988		<b>PLYMOUTH</b> RELIANT	2.2L L4 135 CID	2011	<b>DODGE</b> ATTITUDE	1.4L L4 1399cc 85 CID	
1982-1983		<b>DODGE</b> 400	2.2L L4 135 CID	2012	<b>DODGE</b> ATTITUDE	1.6L L4 1599cc 98 CID	
1982-1984		<b>DODGE</b> RAMPAGE	2.2L L4 135 CID	<b>US7117</b>	1983-1985	<b>DODGE</b> POWER RAM 50	2.3L L4 2346cc
1982-1988		<b>CHRYSLER</b> LEBARON	2.2L L4 135 CID		1983-1985	<b>DODGE</b> RAM 50	2.3L L4 2346cc 143 CID
1982-1988		<b>CHRYSLER</b> TOWN & COUNTRY	2.2L L4 135 CID	1983-1985	<b>MITSUBISHI</b> MIGHTY MAX	2.3L L4 2346cc 143 CID	
1983		<b>PLYMOUTH</b> SCAMP	2.2L L4 135 CID	1983-1988	<b>MITSUBISHI</b> CORDIA	1.8L L4 1795cc	
1983-1984		<b>CHRYSLER</b> E CLASS	2.2L L4 135 CID	1983-1988	<b>MITSUBISHI</b> TREDIA	1.8L L4 1795cc	
1983-1984		<b>PLYMOUTH</b> TURISMO	2.2L L4 135 CID	1984	<b>DODGE</b> COLT	2.0L L4 1995cc 122 CID	
1983-1986		<b>PLYMOUTH</b> TURISMO 2.2	2.2L L4 135 CID	1984-1988	<b>MITSUBISHI</b> CORDIA	2.0L L4 1997cc 122 CID	
1983-1988		<b>CHRYSLER</b> NEW YORKER	2.2L L4 135 CID	1984-1988	<b>MITSUBISHI</b> TREDIA	2.0L L4 1997cc 122 CID	
1983-1988		<b>DODGE</b> 600	2.2L L4 135 CID	1984-1991	<b>PLYMOUTH</b> COLT	2.0L L4 1997cc 122 CID	
1984-1986		<b>CHRYSLER</b> LASER	2.2L L4 135 CID	1985-1987	<b>MITSUBISHI</b> GALANT	2.4L L4 2351cc	
1984-1987		<b>DODGE</b> CARAVAN	2.2L L4 135 CID	1985-1991	<b>DODGE</b> COLT	2.0L L4 1997cc 122 CID	
1984-1987		<b>DODGE</b> CHARGER	2.2L L4 135 CID	1989-1991	<b>HYUNDAI</b> SONATA	2.4L L4 2351cc	
1984-1987		<b>DODGE</b> MINI RAM	2.2L L4 135 CID	<b>US7120</b>	1976-1977	<b>DODGE</b> COLT	2.0L L4 1995cc 122 CID
1984-1987		<b>PLYMOUTH</b> VOYAGER	2.2L L4 135 CID		1976-1978	<b>PLYMOUTH</b> ARROW	2.0L L4 1997cc 122 CID
1984-1988		<b>DODGE</b> DAYTONA	2.2L L4 135 CID	1976-1978	<b>PLYMOUTH</b> COLT	2.0L L4 1995cc 122 CID	
1985-1988		<b>DODGE</b> LANCER	2.2L L4 135 CID	1978-1979	<b>PLYMOUTH</b> COLT	2.6L L4 2555cc 156 CID	
1985-1988		<b>PLYMOUTH</b> CARAVELLE	2.2L L4 135 CID	1978-1980	<b>DODGE</b> COLT	2.6L L4 2555cc 156 CID	
1986		<b>CHRYSLER</b> LASER	2.5L L4 2507cc 153 CID	1978-1981	<b>PLYMOUTH</b> SAPPORO	2.6L L4 2555cc 156 CID	
1986-1987		<b>CHRYSLER</b> NEW YORKER	2.5L L4 2507cc 153 CID	1978-1983	<b>DODGE</b> CHALLENGER	2.6L L4 2555cc 156 CID	
1986-1987		<b>PLYMOUTH</b> TURISMO	2.2L L4 135 CID	1979-1980	<b>DODGE</b> D50	2.0L L4 1995cc 122 CID	
1986-1988		<b>CHRYSLER</b> LEBARON	2.5L L4 2507cc 153 CID	1979-1980	<b>PLYMOUTH</b> ARROW	2.6L L4 2555cc 156 CID	
1986-1988		<b>CHRYSLER</b> TOWN & COUNTRY	2.5L L4 2507cc 153 CID	1979-1982	<b>DODGE</b> D50	2.6L L4 2555cc 156 CID	
1986-1988		<b>DODGE</b> 600	2.5L L4 2507cc 153 CID	1979-1982	<b>PLYMOUTH</b> ARROW PICKUP	2.0L L4 1997cc 122 CID	
1986-1988		<b>DODGE</b> ARIES	2.5L L4 2507cc 153 CID	1979-1982	<b>PLYMOUTH</b> ARROW PICKUP	2.6L L4 2555cc 156 CID	
1986-1988		<b>DODGE</b> DAYTONA	2.5L L4 2507cc 153 CID	1981-1982	<b>DODGE</b> D50	2.0L L4 1997cc 122 CID	
1986-1988		<b>DODGE</b> LANCER	2.5L L4 2507cc 153 CID	1983-1987	<b>MITSUBISHI</b> STARION	2.6L L4 2555cc 156 CID	
1986-1988		<b>PLYMOUTH</b> CARAVELLE	2.5L L4 2507cc 153 CID	1983-1989	<b>MITSUBISHI</b> MIGHTY MAX	2.6L L4 2555cc 156 CID	
1986-1988		<b>PLYMOUTH</b> RELIANT	2.5L L4 2507cc 153 CID	1983-1989	<b>MITSUBISHI</b> MONTERO	2.6L L4 2555cc 156 CID	
1987-1988	<b>DODGE</b> DAKOTA	2.2L L4 135 CID	1984	<b>DODGE</b> POWER RAM 50	2.6L L4 2555cc		
1987-1988	<b>DODGE</b> SHADOW	2.2L L4 135 CID	1984-1989	<b>DODGE</b> RAM 50	2.6L L4 2555cc 156 CID		
1987-1988	<b>PLYMOUTH</b> SUNDANCE	2.2L L4 135 CID	1985-1986	<b>DODGE</b> CONQUEST	2.6L L4 2555cc 156 CID		
1987-1988	<b>PLYMOUTH</b> VOYAGER	2.5L L4 2507cc 153 CID	1985-1986	<b>DODGE</b> POWER RAM 50	2.6L L4 2555cc 156 CID		
1988	<b>DODGE</b> CARAVAN	2.5L L4 2507cc 153 CID	1985-1986	<b>PLYMOUTH</b> CONQUEST	2.6L L4 2555cc 156 CID		
1988	<b>DODGE</b> DYNASTY	2.5L L4 2507cc 153 CID	1987	<b>CHRYSLER</b> CONQUEST	2.6L L4 2555cc 156 CID		
1988	<b>DODGE</b> GRAND CARAVAN	2.5L L4 2507cc 153 CID	1987-1988	<b>MAZDA</b> B2600	2.6L L4 2555cc		
1988	<b>DODGE</b> SHADOW	2.5L L4 2507cc 153 CID	1987-1989	<b>DODGE</b> RAIDER	2.6L L4 2555cc 156 CID		
1988	<b>PLYMOUTH</b> GRAND VOYAGER	2.5L L4 2507cc 153 CID	1987-1988	<b>DODGE</b> MINI RAM	3.0L V6 2972cc 181 CID		
1988	<b>PLYMOUTH</b> SUNDANCE	2.5L L4 2507cc 153 CID	1987-2000	<b>DODGE</b> CARAVAN	3.0L V6 2972cc 181 CID		
1990	<b>CHRYSLER</b> TC MASERATI	2.2L L4 135 CID	1987-2000	<b>PLYMOUTH</b> VOYAGER	3.0L V6 2972cc 181 CID		
<b>US7111</b>	1981-1985	<b>DODGE</b> ARIES	2.6L L4 2555cc 156 CID	1988	<b>MITSUBISHI</b> GALANT	3.0L V6 2972cc 181 CID	
	1981-1985	<b>PLYMOUTH</b> RELIANT	2.6L L4 2555cc 156 CID	1988-1989	<b>CHRYSLER</b> NEW YORKER	3.0L V6 2972cc 181 CID	
	1982	<b>CHRYSLER</b> TOWN & COUNTRY	2.6L L4 2555cc 156 CID	1988-1989	<b>DODGE</b> GRAND CARAVAN	3.0L V6 2972cc 181 CID	
	1982-1983	<b>DODGE</b> 400	2.6L L4 2555cc 156 CID	1988-1989	<b>PLYMOUTH</b> GRAND VOYAGER	3.0L V6 2972cc 181 CID	
	1982-1985	<b>CHRYSLER</b> LEBARON	2.6L L4 2555cc 156 CID	1988-1993	<b>DODGE</b> DYNASTY	3.0L V6 2972cc 181 CID	
	1983-1984	<b>CHRYSLER</b> E CLASS	2.6L L4 2555cc 156 CID	1989	<b>DODGE</b> RAIDER	3.0L V6 2972cc 181 CID	
	1983-1984	<b>CHRYSLER</b> EXECUTIVE SEDAN	2.6L L4 2555cc 156 CID	1989-1990	<b>MITSUBISHI</b> SIGMA	3.0L V6 2972cc 181 CID	
	1983-1985	<b>CHRYSLER</b> NEW YORKER	2.6L L4 2555cc 156 CID	1989-1992	<b>CHRYSLER</b> SPIRIT	3.0L V6 2966cc 181 CID	
	1983-1985	<b>DODGE</b> 600	2.6L L4 2555cc 156 CID	1989-1994	<b>MITSUBISHI</b> MONTERO	3.0L V6 2972cc 181 CID	
	1984-1985	<b>CHRYSLER</b> TOWN & COUNTRY	2.6L L4 2555cc 156 CID	1989-1995	<b>DODGE</b> SPIRIT	3.0L V6 2972cc 181 CID	
	1984-1987	<b>DODGE</b> CARAVAN	2.6L L4 2555cc 156 CID	1989-1995	<b>PLYMOUTH</b> ACCLAIM	3.0L V6 2972cc 181 CID	
	1984-1987	<b>DODGE</b> MINI RAM	2.6L L4 2555cc 156 CID	1990-1991	<b>CHRYSLER</b> TC MASERATI	3.0L V6 2972cc 181 CID	
	1984-1987	<b>PLYMOUTH</b> VOYAGER	2.6L L4 2555cc 156 CID	1990-1991	<b>DODGE</b> RAM 50	3.0L V6 2972cc 181 CID	

WATER PUMPS



USMW	Years	Application	Engine	USMW	Years	Application	Engine		
<b>US7121</b>	1990-1993	<b>DODGE DAYTONA</b>	3.0L V6 2972cc 181 CID	<b>US7126</b>	1993-1999	<b>CHRYSLER VOYAGER</b>	3.3L V6 3294cc 201 CID		
	1990-1994	<b>MITSUBISHI MIGHTY MAX</b>	3.0L V6 2972cc 181 CID		1994-1995	<b>PLYMOUTH GRAND VOYAGER</b>	3.8L V6 230 CID		
	1990-1995	<b>CHRYSLER LEBARON</b>	3.0L V6 2972cc 181 CID		1994-2000	<b>CHRYSLER TOWN &amp; COUNTRY</b>	3.8L V6 230 CID		
	1990-1998	<b>HYUNDAI SONATA</b>	3.0L V6 2972cc		1994-2000	<b>DODGE GRAND CARAVAN</b>	3.8L V6 230 CID		
	1991-1996	<b>DODGE STEALTH</b>	3.0L V6 2972cc 181 CID		1996-1999	<b>DODGE CARAVAN</b>	3.8L V6 230 CID		
	1992	<b>CHRYSLER SHADOW</b>	3.0L V6 2966cc 181 CID		1996-2000	<b>CHRYSLER TOWN &amp; COUNTRY</b>	3.3L V6 3301cc 201 CID		
	1992-1994	<b>CHRYSLER NEW YORKER</b>	3.0L V6 3000cc 183 CID		1997	<b>PLYMOUTH GRAND VOYAGER</b>	3.8L V6 3800cc 232 CID		
	1992-1994	<b>CHRYSLER VOYAGER</b>	3.0L V6 2966cc 181 CID		1998-2001	<b>CHRYSLER GRAND VOYAGER</b>	3.8L V6 3800cc 232 CID		
	1992-1994	<b>DODGE SHADOW</b>	3.0L V6 2972cc 181 CID		1999	<b>PLYMOUTH GRAND VOYAGER</b>	3.8L V6 230 CID		
	1992-1994	<b>PLYMOUTH SUNDANCE</b>	3.0L V6 2972cc 181 CID		1999	<b>PLYMOUTH VOYAGER</b>	3.8L V6 230 CID		
	1992-1996	<b>MITSUBISHI DIAMANTE</b>	3.0L V6 2972cc 181 CID		2000	<b>CHRYSLER GRAND VOYAGER</b>	3.3L V6 3301cc 201 CID		
	1992-2000	<b>DODGE GRAND CARAVAN</b>	3.0L V6 2972cc 181 CID		2000	<b>CHRYSLER VOYAGER</b>	3.3L V6 3301cc 201 CID		
	1992-2000	<b>PLYMOUTH GRAND VOYAGER</b>	3.0L V6 2972cc 181 CID		<b>US7127</b>	1990	<b>CHRYSLER LEBARON</b>	2.2L L4 135 CID	
	1996-1997	<b>CHRYSLER VOYAGER</b>	3.0L V6 2966cc 181 CID			1990	<b>CHRYSLER PHANTOM</b>	2.2L L4 2200cc 135 CID	
	1997-1999	<b>MITSUBISHI 3000GT</b>	3.0L V6 2972cc 181 CID			1990	<b>DODGE DAYTONA</b>	2.2L L4 135 CID	
	2000	<b>CHRYSLER GRAND VOYAGER</b>	3.0L V6 2972cc 181 CID			1990	<b>DODGE OMNI</b>	2.2L L4 135 CID	
	2000	<b>CHRYSLER VOYAGER</b>	3.0L V6 2972cc 181 CID			1990	<b>DODGE SHADOW</b>	2.2L L4 2200cc 135 CID	
	<b>US7121-2</b>	1987-1988	<b>DODGE MINI RAM</b>			3.0L V6 2972cc 181 CID	1990	<b>DODGE SHADOW</b>	2.5L L4 2500cc 153 CID
		1987-2000	<b>DODGE CARAVAN</b>			3.0L V6 2972cc 181 CID	1990	<b>DODGE SPIRIT</b>	2.5L L4 2500cc 153 CID
		1987-2000	<b>PLYMOUTH VOYAGER</b>			3.0L V6 2972cc 181 CID	1990	<b>PLYMOUTH HORIZON</b>	2.2L L4 135 CID
1988		<b>MITSUBISHI GALANT</b>	3.0L V6 2972cc 181 CID	1990-1991		<b>CHRYSLER SHADOW</b>	2.2L L4 2212cc 135 CID		
1988-1989		<b>CHRYSLER NEW YORKER</b>	3.0L V6 2972cc 181 CID	1990-1993		<b>CHRYSLER LEBARON</b>	2.5L L4 2507cc 153 CID		
1988-1989		<b>DODGE GRAND CARAVAN</b>	3.0L V6 2972cc 181 CID	1990-1993		<b>DODGE DAYTONA</b>	2.5L L4 2507cc 153 CID		
1988-1989		<b>PLYMOUTH GRAND VOYAGER</b>	3.0L V6 2972cc 181 CID	1990-1993		<b>DODGE DYNASTY</b>	2.5L L4 2507cc 153 CID		
1988-1993		<b>DODGE DYNASTY</b>	3.0L V6 2972cc 181 CID	1990-1994		<b>CHRYSLER PHANTOM</b>	2.5L L4 2500cc 153 CID		
1989		<b>DODGE RAIDER</b>	3.0L V6 2972cc 181 CID	1990-1994		<b>CHRYSLER SHADOW</b>	2.5L L4 2507cc 153 CID		
1989-1990		<b>MITSUBISHI SIGMA</b>	3.0L V6 2972cc 181 CID	1990-1994		<b>DODGE SHADOW</b>	2.2L L4 135 CID		
1989-1994		<b>MITSUBISHI MONTERO</b>	3.0L V6 2972cc 181 CID	1990-1994		<b>DODGE SHADOW</b>	2.5L L4 2507cc 153 CID		
1989-1995		<b>DODGE SPIRIT</b>	3.0L V6 2972cc 181 CID	1990-1994		<b>PLYMOUTH SUNDANCE</b>	2.2L L4 135 CID		
1989-1995		<b>PLYMOUTH ACCLAIM</b>	3.0L V6 2972cc 181 CID	1990-1994		<b>PLYMOUTH SUNDANCE</b>	2.5L L4 2507cc 153 CID		
1990-1991		<b>CHRYSLER TC MASERATI</b>	3.0L V6 2972cc 181 CID	1990-1995		<b>CHRYSLER SPIRIT</b>	2.5L L4 2507cc 153 CID		
1990-1991		<b>DODGE RAM 50</b>	3.0L V6 2972cc 181 CID	1990-1995		<b>CHRYSLER VOYAGER</b>	2.5L L4 2507cc 153 CID		
1990-1993		<b>DODGE DAYTONA</b>	3.0L V6 2972cc 181 CID	1990-1995	<b>DODGE CARAVAN</b>	2.5L L4 2507cc 153 CID			
1990-1994		<b>MITSUBISHI MIGHTY MAX</b>	3.0L V6 2972cc 181 CID	1990-1995	<b>DODGE DAKOTA</b>	2.5L L4 2507cc 153 CID			
1990-1995		<b>CHRYSLER LEBARON</b>	3.0L V6 2972cc 181 CID	1990-1995	<b>DODGE SPIRIT</b>	2.5L L4 2507cc 153 CID			
1990-1998		<b>HYUNDAI SONATA</b>	3.0L V6 2972cc	1990-1995	<b>PLYMOUTH ACCLAIM</b>	2.5L L4 2507cc 153 CID			
1991-1996		<b>DODGE STEALTH</b>	3.0L V6 2972cc 181 CID	1990-1995	<b>PLYMOUTH VOYAGER</b>	2.5L L4 2507cc 153 CID			
1992-1994	<b>DODGE SHADOW</b>	3.0L V6 2972cc 181 CID	1993	<b>DODGE SPIRIT</b>	2.2L L4 2200cc 135 CID				
1992-1994	<b>PLYMOUTH SUNDANCE</b>	3.0L V6 2972cc 181 CID	1993-1994	<b>DODGE SHADOW</b>	2.5L L4 2500cc 153 CID				
1992-1996	<b>MITSUBISHI DIAMANTE</b>	3.0L V6 2972cc 181 CID	1993-1995	<b>CHRYSLER LEBARON</b>	2.5L L4 2500cc 153 CID				
1992-2000	<b>DODGE GRAND CARAVAN</b>	3.0L V6 2972cc 181 CID	1993-1995	<b>DODGE SPIRIT</b>	2.5L L4 2500cc 153 CID				
1992-2000	<b>PLYMOUTH GRAND VOYAGER</b>	3.0L V6 2972cc 181 CID	<b>US7128</b>	1990-1991	<b>DODGE DAKOTA</b>	5.2L V8 5211cc 318 CID			
1997-1999	<b>MITSUBISHI 3000GT</b>	3.0L V6 2972cc 181 CID		<b>US7129</b>	1991-1999	<b>MITSUBISHI 3000GT</b>	3.0L V6 2972cc 181 CID		
2000	<b>CHRYSLER GRAND VOYAGER</b>	3.0L V6 2972cc 181 CID	1992-1994		<b>MITSUBISHI DIAMANTE</b>	3.0L V6 2972cc 181 CID			
2000	<b>CHRYSLER VOYAGER</b>	3.0L V6 2972cc 181 CID	1994-1996	<b>DODGE STEALTH</b>	3.0L V6 2972cc 181 CID				
<b>US7122</b>	1989	<b>CHRYSLER DART</b>	2.2L L4 2200cc 135 CID	<b>US7131</b>	1989	<b>MITSUBISHI MIRAGE</b>	1.6L L4 1597cc 98 CID		
	1989	<b>CHRYSLER LEBARON</b>	2.2L L4 135 CID		1989-1990	<b>DODGE COLT</b>	1.6L L4 1597cc 98 CID		
	1989	<b>CHRYSLER LEBARON</b>	2.5L L4 2507cc 153 CID	1989-1990	<b>EAGLE SUMMIT</b>	1.6L L4 1597cc 98 CID			
	1989	<b>CHRYSLER PHANTOM</b>	2.2L L4 2200cc 135 CID	1989-1990	<b>PLYMOUTH COLT</b>	1.6L L4 1597cc 98 CID			
	1989	<b>CHRYSLER SHADOW</b>	2.2L L4 2212cc 135 CID	1991-1992	<b>MITSUBISHI MIRAGE</b>	1.6L L4 1597cc 98 CID			
	1989	<b>CHRYSLER SHADOW</b>	2.5L L4 2507cc 153 CID	1992-1995	<b>HYUNDAI ELANTRA</b>	1.6L L4 1596cc			
	1989	<b>CHRYSLER SPIRIT</b>	2.5L L4 2507cc 153 CID	<b>US7135</b>	1992-1994	<b>MITSUBISHI EXPO LRV</b>	1.8L L4 1834cc 112 CID		
	1989	<b>CHRYSLER TC MASERATI</b>	2.2L L4 135 CID		1992-1994	<b>PLYMOUTH COLT</b>	1.8L L4 1834cc 112 CID		
	1989	<b>DODGE ARIES</b>	2.2L L4 135 CID	1992-1996	<b>EAGLE SUMMIT</b>	1.8L L4 1834cc 112 CID			
	1989	<b>DODGE ARIES</b>	2.5L L4 2507cc 153 CID	1993-1994	<b>DODGE COLT</b>	1.8L L4 1834cc 112 CID			
	1989	<b>DODGE CARAVAN</b>	2.5L L4 2507cc 153 CID	1993-1996	<b>MITSUBISHI MIRAGE</b>	1.8L L4 1834cc 112 CID			
	1989	<b>DODGE DAKOTA</b>	2.5L L4 2507cc 153 CID	<b>US7136</b>	1991-1992	<b>JEEP COMANCHE</b>	2.5L L4 150 CID		
	1989	<b>DODGE DART</b>	2.2L L4 2200cc 135 CID		1991-1995	<b>JEEP WRANGLER</b>	2.5L L4 150 CID		
	1989	<b>DODGE DAYTONA</b>	2.2L L4 135 CID	1991-1995	<b>JEEP WRANGLER</b>	4.0L L6 242 CID			
	1989	<b>DODGE DAYTONA</b>	2.5L L4 2507cc 153 CID	1991-2000	<b>JEEP CHEROKEE</b>	2.5L L4 150 CID			
	1989	<b>DODGE DYNASTY</b>	2.5L L4 2507cc 153 CID	1993-1998	<b>JEEP GRAND CHEROKEE</b>	4.0L L6 242 CID			
	1989	<b>DODGE LANCER</b>	2.2L L4 135 CID	1996-2002	<b>DODGE DAKOTA</b>	2.5L L4 2507cc 153 CID			
	1989	<b>DODGE LANCER</b>	2.5L L4 2507cc 153 CID	1997-1999	<b>JEEP WRANGLER</b>	4.0L L6 242 CID			
	1989	<b>DODGE OMNI</b>	2.2L L4 135 CID	1997-2002	<b>JEEP WRANGLER</b>	2.5L L4 150 CID			
	1989	<b>DODGE SHADOW</b>	2.2L L4 135 CID	<b>US7137</b>	1992-1993	<b>DODGE VIPER</b>	8.0L V10 7990cc 488 CID		
1989	<b>DODGE SHADOW</b>	2.2L L4 2200cc 135 CID	<b>US7139</b>		1991-1992	<b>DODGE SPIRIT</b>	2.2L L4 135 CID		
1989	<b>DODGE SHADOW</b>	2.5L L4 2507cc 153 CID		1992-1993	<b>DODGE DAYTONA</b>	2.2L L4 135 CID			
1989	<b>DODGE SPIRIT</b>	2.5L L4 2500cc 153 CID	<b>US7140</b>	1992	<b>CHRYSLER CONCORDE</b>	3.3L V6 3294cc 201 CID			
1989	<b>DODGE SPIRIT</b>	2.5L L4 2507cc 153 CID		1993-1996	<b>CHRYSLER CONCORDE</b>	3.3L V6 3301cc 201 CID			
1989	<b>PLYMOUTH ACCLAIM</b>	2.5L L4 2507cc 153 CID	1993-1997	<b>DODGE INTREPID</b>	3.3L V6 3301cc 201 CID				
1989	<b>PLYMOUTH HORIZON</b>	2.2L L4 135 CID	1993-1997	<b>EAGLE VISION</b>	3.3L V6 3301cc 201 CID				
1989	<b>PLYMOUTH RELIANT</b>	2.2L L4 135 CID	<b>US7141</b>	1992	<b>CHRYSLER CONCORDE</b>	3.5L V6 3526cc 215 CID			
1989	<b>PLYMOUTH RELIANT</b>	2.5L L4 2507cc 153 CID		1993-1994	<b>CHRYSLER CONCORDE</b>	3.5L V6 3497cc 215 CID			
1989	<b>PLYMOUTH SUNDANCE</b>	2.2L L4 135 CID	1993-1994	<b>DODGE INTREPID</b>	3.5L V6 3497cc 215 CID				
1989	<b>PLYMOUTH SUNDANCE</b>	2.5L L4 2507cc 153 CID	1993-1994	<b>EAGLE VISION</b>	3.5L V6 3497cc 215 CID				
1989	<b>PLYMOUTH VOYAGER</b>	2.5L L4 2507cc 153 CID	1994	<b>CHRYSLER LHS</b>	3.5L V6 3497cc 215 CID				
<b>US7124</b>	1987-1989	<b>CHRYSLER CONQUEST</b>	2.6L L4 2555cc 156 CID	1994	<b>CHRYSLER NEW YORKER</b>	3.5L V6 3497cc 215 CID			
	1987-1989	<b>MITSUBISHI STARION</b>	2.6L L4 2555cc 156 CID	<b>US7145</b>	1989-1993	<b>DODGE D250</b>	5.9L L6 359 CID		
<b>US7126</b>	1990-1991	<b>CHRYSLER IMPERIAL</b>	3.3L V6 3301cc 201 CID		1989-1993	<b>DODGE D350</b>	5.9L L6 359 CID		
	1990-1993	<b>CHRYSLER NEW YORKER</b>	3.3L V6 3301cc 201 CID		1989-1993	<b>DODGE W250</b>	5.9L L6 359 CID		
	1990-1993	<b>CHRYSLER TOWN &amp; COUNTRY</b>	3.3L V6 3301cc 201 CID		1989-1993	<b>DODGE W350</b>	5.9L L6 359 CID		
	1990-1993	<b>DODGE DYNASTY</b>	3.3L V6 3301cc 201 CID		1994-1998	<b>DODGE RAM 2500</b>	5.9L L6 359 CID		
	1990-2000	<b>DODGE GRAND CARAVAN</b>	3.3L V6 3301cc 201 CID		1994-1998	<b>DODGE RAM 3500</b>	5.9L L6 359 CID		
	1990-2000	<b>PLYMOUTH GRAND VOYAGER</b>	3.3L V6 3301cc 201 CID		2003-2007	<b>DODGE RAM 2500</b>	5.9L L6 359 CID		
	1991-1993	<b>CHRYSLER IMPERIAL</b>	3.8L V6 230 CID		2004-2007	<b>DODGE RAM 3500</b>	5.9L L6 359 CID		
	1991-1993	<b>CHRYSLER NEW YORKER</b>	3.8L V6 230 CID		<b>US7145HN</b>	1998-2007	<b>DODGE RAM 3500</b>	5.9L L6 359 CID	
	1991-1995	<b>CHRYSLER GRAND VOYAGER</b>	3.8L V6 3800cc 231 CID			1998-2009	<b>DODGE RAM 2500</b>	5.9L L6 359 CID	
	1991-2000	<b>DODGE CARAVAN</b>	3.3L V6 3301cc 201 CID	<b>US7145N</b>	1989-1993	<b>DODGE D250</b>	5.9L L6 359 CID		
1991-2000	<b>PLYMOUTH VOYAGER</b>	3.3L V6 3301cc 201 CID	1989-1993		<b>DODGE D350</b>	5.9L L6 359 CID			

USMW	Years	Application	Engine	USMW	Years	Application	Engine
<b>US7145N</b>	1993-1994	FORD F600	5.9L L6 359 CID	<b>US7158</b>	1997	PLYMOUTH PROWLER	3.5L V6 3497cc 215 CID
	1993-1994	FORD F600 LPO	5.9L L6 359 CID	<b>US7159</b>	1992	DODGE B150	3.9L V6 3906cc 239 CID
	1993-1997	FORD CF7000	5.9L L6 359 CID		1992	DODGE B150	5.2L V8 5211cc 318 CID
	1993-1997	FORD F700	5.9L L6 359 CID		1992	DODGE B250	3.9L V6 3906cc 239 CID
	1993-1997	FORD LN7000	5.9L L6 359 CID		1992	DODGE B250	5.2L V8 5211cc 318 CID
	1993-1999	FORD F800	5.9L L6 359 CID		1992	DODGE B350	5.2L V8 5211cc 318 CID
	1994-2001	DODGE RAM 2500	5.9L L6 359 CID		1992	DODGE D150	3.9L V6 3906cc 239 CID
	1994-2001	DODGE RAM 3500	5.9L L6 359 CID		1992	DODGE D150	5.2L V8 5211cc 318 CID
1995-1998	FORD F800 LPO	5.9L L6 359 CID	1992		DODGE D250	3.9L V6 3906cc 239 CID	
<b>US7146</b>	1994-1996	DODGE VIPER	8.0L V10 7990cc 488 CID		1992	DODGE D250	5.2L V8 5211cc 318 CID
<b>US7148</b>	1993	MINISUBISHI GALANT	2.0L L4 1997cc 122 CID		1992	DODGE DAKOTA	3.9L V6 3906cc 239 CID
	1993-1994	MINISUBISHI EXPO LRV	2.4L L4 2351cc	1992	DODGE DAKOTA	5.2L V8 5211cc 318 CID	
	1993-1994	PLYMOUTH COLT	2.4L L4 2351cc	1992	DODGE MICROBUS	5.9L V8 5900cc 360 CID	
	1993-1995	MINISUBISHI EXPO	2.4L L4 2351cc	1992	DODGE RAMCHARGER	5.2L V8 5211cc 318 CID	
	1993-1996	EAGLE SUMMIT	2.4L L4 2351cc	1992	DODGE W150	3.9L V6 3906cc 239 CID	
	1994-1998	MINISUBISHI GALANT	2.4L L4 2351cc	1992	DODGE W150	5.2L V8 5211cc 318 CID	
	1995-1998	EAGLE TALON	2.0L L4 1997cc 122 CID	1992	DODGE W250	5.2L V8 5211cc 318 CID	
	1995-1999	MINISUBISHI ECLIPSE	2.0L L4 1997cc 122 CID	1993	DODGE D150	3.9L V6 3906cc 239 CID	
	1996-1999	MINISUBISHI ECLIPSE	2.4L L4 2351cc	1993	DODGE D150	5.2L V8 5211cc 318 CID	
	<b>US7150</b>	1995	CHRYSLER CIRRUS	2.0L L4 2001cc 122 CID	1993	DODGE D150	5.9L V8 360 CID
1995		DODGE NEON	2.0L L4 1997cc 122 CID	1993	DODGE D250	3.9L V6 3906cc 239 CID	
1995-1998		EAGLE TALON	2.0L L4 1997cc 122 CID	1993	DODGE D250	5.2L V8 5211cc 318 CID	
1995-1999		CHRYSLER SEBRING	2.0L L4 1996cc 122 CID	1993	DODGE D250	5.9L V8 360 CID	
1995-1999		DODGE AVENGER	2.0L L4 1996cc 122 CID	1993	DODGE D350	5.9L V8 360 CID	
1995-1999		MINISUBISHI ECLIPSE	2.0L L4 1997cc 122 CID	1993	DODGE RAMCHARGER	5.2L V8 5211cc 318 CID	
1995-2000		DODGE STRATUS	2.0L L4 1996cc 122 CID	1993	DODGE RAMCHARGER	5.9L V8 360 CID	
1995-2001		PLYMOUTH NEON	2.0L L4 1996cc 122 CID	1993	DODGE W150	3.9L V6 3906cc 239 CID	
1995-2005		DODGE NEON	2.0L L4 1996cc 122 CID	1993	DODGE W150	5.2L V8 5211cc 318 CID	
1996-2000		PLYMOUTH BREEZE	2.0L L4 1996cc 122 CID	1993	DODGE W250	5.2L V8 5211cc 318 CID	
2000		CHRYSLER CIRRUS	2.0L L4 1996cc 122 CID	1993	DODGE W250	5.9L V8 360 CID	
1995-1996		CHRYSLER NEW YORKER	3.5L V6 3497cc 215 CID	1993	DODGE W350	5.9L V8 360 CID	
1995-1997		CHRYSLER CONCORDE	3.5L V6 3497cc 215 CID	1993	JEEP GRAND WAGONEER	5.2L V8 5211cc 318 CID	
1995-1997		CHRYSLER LHS	3.5L V6 3497cc 215 CID	1993-1994	DODGE B150	3.9L V6 3906cc 239 CID	
1995-1997		DODGE INTREPID	3.5L V6 3497cc 215 CID	1993-1994	DODGE B150	5.2L V8 5211cc 318 CID	
1995-1997		EAGLE VISION	3.5L V6 3497cc 215 CID	1993-1994	DODGE B250	3.9L V6 3906cc 239 CID	
1997		PLYMOUTH PROWLER	3.5L V6 3497cc 215 CID	1993-1994	DODGE B250	5.2L V8 5211cc 318 CID	
<b>US7152</b>		1995-2000	CHRYSLER CIRRUS	2.5L V6 2497cc 152 CID	1993-1994	DODGE B250	5.9L V8 360 CID
	1995-2000	CHRYSLER SEBRING	2.5L V6 2497cc 152 CID	1993-1994	DODGE B350	5.2L V8 5211cc 318 CID	
	1995-2000	DODGE AVENGER	2.5L V6 2497cc 152 CID	1993-1994	DODGE B350	5.9L V8 360 CID	
	1995-2000	DODGE STRATUS	2.5L V6 2497cc 152 CID	1993-1997	DODGE MICROBUS	5.9L V8 5900cc 360 CID	
	1997-2004	MINISUBISHI DIAMANTE	3.5L V6 3497cc 215 CID	1993-1998	JEEP GRAND CHEROKEE	5.2L V8 5211cc 318 CID	
	1998	CHRYSLER CIRRUS	2.4L L4 2426cc 148 CID	1993-1999	DODGE DAKOTA	5.2L V8 5211cc 318 CID	
	1999-2003	MINISUBISHI GALANT	3.0L V6 2972cc 181 CID	1993-2003	DODGE DAKOTA	3.9L V6 3906cc 239 CID	
	2000-2005	MINISUBISHI ECLIPSE	3.0L V6 2972cc 181 CID	1994-1996	DODGE RAM 2500	5.2L V8 5211cc 318 CID	
	2001-2005	CHRYSLER SEBRING	3.0L V6 2972cc 181 CID	1994-2000	DODGE RAMCHARGER	5.9L V8 5900cc 360 CID	
	2001-2005	DODGE STRATUS	3.0L V6 2972cc 181 CID	1994-2001	DODGE RAM 1500	3.9L V6 3906cc 239 CID	
	2004	MINISUBISHI ENDEAVOR	3.8L V6 3797cc 230 CID	1994-2001	DODGE RAM 1500	5.2L V8 5211cc 318 CID	
	2004-2009	MINISUBISHI GALANT	3.8L V6 3828cc 230 CID	1994-2002	DODGE RAM 2500	5.9L V8 360 CID	
	2005-2008	MINISUBISHI ENDEAVOR	3.8L V6 3828cc 230 CID	1994-2002	DODGE RAM 3500	5.9L V8 360 CID	
	2005-2008	MINISUBISHI MONTERO SPORT	3.5L V6 3497cc 213 CID	1994-2003	DODGE RAM 1500	5.9L V8 360 CID	
	2006-2011	MINISUBISHI ECLIPSE	3.8L V6 3828cc 230 CID	1995-1997	DODGE B2500	3.9L V6 3906cc 239 CID	
	2008-2009	MINISUBISHI MONTERO	3.8L V6 3800cc 232 CID	1995-1998	DODGE B1500	3.9L V6 3906cc 239 CID	
	2010	MINISUBISHI MONTERO	3.8L V6 3828cc 234 CID	1995-1998	DODGE B1500	5.2L V8 5211cc 318 CID	
	2010-2011	MINISUBISHI ENDEAVOR	3.8L V6 3828cc 230 CID	1995-1998	DODGE B2500	5.2L V8 5211cc 318 CID	
	2010-2011	MINISUBISHI ENDEAVOR	3.8L V6 3828cc 234 CID	1995-1998	DODGE B2500	5.9L V8 360 CID	
	2011	MINISUBISHI MONTERO LIMITED	3.8L V6 3828cc 234 CID	1995-1998	DODGE B3500	5.2L V8 5211cc 318 CID	
	<b>US7153</b>	1995-1996	CHRYSLER CIRRUS	2.4L L4 2429cc 148 CID	1995-1998	DODGE B3500	5.9L V8 360 CID
		1995-1996	DODGE STRATUS	2.4L L4 2429cc 148 CID	1997-2001	DODGE RAM 2500	5.2L V8 5215cc 318 CID
		1996	CHRYSLER SEBRING	2.4L L4 2429cc 148 CID	1997-2001	DODGE RAM 4000	5.9L V8 5900cc 360 CID
		1996	DODGE CARAVAN	2.4L L4 2429cc 148 CID	1998	DODGE B1500	5.9L V8 360 CID
		1996	DODGE GRAND CARAVAN	2.4L L4 2429cc 148 CID	1998	DODGE DURANGO	5.2L V8 5215cc 318 CID
		1996	PLYMOUTH GRAND VOYAGER	2.4L L4 2429cc 148 CID	1998	JEEP GRAND CHEROKEE	5.9L V8 360 CID
		1996	PLYMOUTH VOYAGER	2.4L L4 2429cc 148 CID	1998-1999	DODGE DURANGO	3.9L V6 3906cc 239 CID
		<b>US7156</b>	1996-1997	CHRYSLER CIRRUS	2.4L L4 2429cc 148 CID	1998-2000	DODGE DURANGO
	1996-1997	CHRYSLER STRATUS	2.4L L4 2429cc 148 CID	1998-2003	DODGE DAKOTA	5.9L V8 360 CID	
	1996-1997	CHRYSLER VOYAGER	2.4L L4 2426cc 148 CID	1998-2003	DODGE DURANGO	5.9L V8 360 CID	
	1996-1997	DODGE GRAND CARAVAN	2.4L L4 2429cc 148 CID	1999-2001	DODGE RAMCHARGER	5.2L V8 5215cc 318 CID	
	1996-1997	PLYMOUTH GRAND VOYAGER	2.4L L4 2429cc 148 CID	1999-2003	DODGE RAM 1500 VAN	3.9L V6 3906cc 239 CID	
1996-1998	CHRYSLER SEBRING	2.4L L4 2429cc 148 CID	1999-2003	DODGE RAM 1500 VAN	5.2L V8 5211cc 318 CID		
1996-2000	PLYMOUTH VOYAGER	2.4L L4 2429cc 148 CID	1999-2003	DODGE RAM 1500 VAN	5.9L V8 360 CID		
1996-2006	DODGE STRATUS	2.4L L4 2429cc 148 CID	1999-2003	DODGE RAM 2500 VAN	5.2L V8 5211cc 318 CID		
1996-2007	DODGE CARAVAN	2.4L L4 2429cc 148 CID	1999-2003	DODGE RAM 2500 VAN	5.9L V8 360 CID		
1997-2000	PLYMOUTH BREEZE	2.4L L4 2429cc 148 CID	1999-2003	DODGE RAM 3500 VAN	5.2L V8 5211cc 318 CID		
1998-2000	DODGE STRATUS	2.4L L4 2426cc 148 CID	1999-2003	DODGE RAM 3500 VAN	5.9L V8 360 CID		
1999-2000	CHRYSLER CIRRUS	2.4L L4 2426cc 148 CID	2001	DODGE RAM 2500 VAN	3.9L V6 3906cc 239 CID		
1999-2003	CHRYSLER CIRRUS	2.4L L4 2429cc 148 CID	2015	DODGE RAM 4000	5.7L V8 5654cc 345 CID		
2000-2003	CHRYSLER VOYAGER	2.4L L4 2429cc 148 CID	<b>US7161</b>	1998-2004	CHRYSLER CONCORDE	2.7L V6 2736cc 167 CID	
2001-2003	DODGE STRATUS	2.0L L4 1998cc 122 CID	1998-2004	DODGE INTREPID	2.7L V6 2736cc 167 CID		
2001-2006	CHRYSLER SEBRING	2.4L L4 2429cc 148 CID	2001-2003	CHRYSLER CIRRUS	2.7L V6 2736cc 165 CID		
2001-2010	CHRYSLER PT CRUISER	2.4L L4 2429cc 148 CID	2001-2006	DODGE STRATUS	2.7L V6 2736cc 167 CID		
2002-2005	JEEP LIBERTY	2.4L L4 148 CID	2001-2007	CHRYSLER SEBRING	2.7L V6 2736cc 167 CID		
2003-2006	JEEP WRANGLER	2.4L L4 148 CID	2004-2006	CHRYSLER CIRRUS	2.7L V6 2737cc 167 CID		
2004	CHRYSLER CIRRUS	2.4L L4 2426cc 148 CID	2005-2007	CHRYSLER 300	2.7L V6 2736cc 167 CID		
2004-2006	DODGE STRATUS	2.0L L4 1996cc 122 CID	2005-2007	DODGE MAGNUM	2.7L V6 2736cc 167 CID		
2005-2009	CHRYSLER CIRRUS	2.4L L4 2429cc 148 CID	2006-2007	DODGE CHARGER	2.7L V6 2736cc 167 CID		
<b>US7158</b>	1997	CHRYSLER CONCORDE	3.5L V6 3497cc 215 CID	<b>US7162</b>	1998-2000	DODGE INTREPID	3.2L V6 3200cc 197 CID
	1997	CHRYSLER LHS	3.5L V6 3497cc 215 CID	1998-2001	CHRYSLER CONCORDE	3.2L V6 3200cc 197 CID	
	1997	DODGE INTREPID	3.5L V6 3497cc 215 CID	1999-2001	CHRYSLER LHS	3.5L V6 3497cc 215 CID	
	1997	EAGLE VISION	3.5L V6 3497cc 215 CID				

WATER PUMPS

USMW	Years	Application	Engine	USMW	Years	Application	Engine
<b>US7162</b>	1999-2001	PLYMOUTH PROWLER	3.5L V6 3497cc 215 CID	<b>US8106</b>	2013	HYUNDAI ELANTRA GT	1.8L L4 1797cc
	1999-2004	CHRYSLER 300M	3.5L V6 3497cc 215 CID		2014	HYUNDAI ELANTRA COUPE	2.0L L4 1999cc
	2000-2004	DODGE INTREPID	3.5L V6 3497cc 215 CID		2014-2016	KIA FORTE	1.8L L4 1797cc
	2001-2002	CHRYSLER PROWLER	3.5L V6 3497cc 215 CID		2014-2016	KIA FORTE KOUP	2.0L L4 1999cc 122 CID
	2002-2004	CHRYSLER CONCORDE	3.5L V6 3497cc 215 CID		2014-2017	HYUNDAI ELANTRA	2.0L L4 1999cc
	2004	CHRYSLER PACIFICA	3.5L V6 3497cc 215 CID		2014-2017	HYUNDAI ELANTRA GT	2.0L L4 1999cc
<b>US7163</b>	1999-2009	JEEP GRAND CHEROKEE	4.7L V8 287 CID	2014-2017	HYUNDAI TUCSON	2.0L L4 1999cc	
	2000-2009	DODGE DURANGO	4.7L V8 287 CID	2014-2017	KIA FORTE	2.0L L4 1999cc 122 CID	
	2000-2010	DODGE DAKOTA	4.7L V8 287 CID	2014-2017	KIA FORTE5	2.0L L4 1999cc 122 CID	
	2002-2009	DODGE RAM 2500	4.7L V8 4700cc 287 CID	2015	HYUNDAI ELANTRA	1.8L L4 1797cc 110 CID	
	2002-2010	DODGE RAM 1500	3.7L V6 226 CID	<b>US8107</b>	2014-2018	FORD FUSION	1.5L L4 1499cc 91 CID
	2002-2010	DODGE RAM 1500	4.7L V8 287 CID		2017-2018	FORD ESCAPE	1.5L L4 1499cc 91 CID
	2002-2012	JEEP LIBERTY	3.7L V6 226 CID	<b>US8108</b>	2014	VOLKSWAGEN PASSAT	2.0L L4 1968cc 120 CID
	2004-2009	DODGE DURANGO	3.7L V6 226 CID		2014-2016	VOLKSWAGEN VENTO	1.6L L4 1598cc 98 CID
	2004-2010	DODGE DAKOTA	3.7L V6 226 CID	<b>US8109</b>	2014-2015	VOLKSWAGEN VENTO	1.6L L4 1598cc 98 CID
	2005-2010	JEEP GRAND CHEROKEE	3.7L V6 226 CID		<b>US8111</b>	2002-2004	VOLKSWAGEN PASSAT
	2006-2007	MITSUBISHI RAIDER	4.7L V8 287 CID	2004		VOLKSWAGEN PHAETON	6.0L W12 6000cc
	2006-2009	JEEP COMMANDER	4.7L V8 287 CID	2005	VOLKSWAGEN PHAETON	6.0L W12 5998cc	
	2006-2009	MITSUBISHI RAIDER	3.7L V6 226 CID	2005-2009	AUDI A8 QUATTRO	6.0L W12 5998cc	
	2006-2010	JEEP COMMANDER	3.7L V6 226 CID	2006	VOLKSWAGEN PHAETON	6.0L W12 5998cc 366 CID	
	2007-2009	CHRYSLER ASPEN	4.7L V8 287 CID		<b>US8112</b>	2013-2015	ACURA ILX
	2007-2011	DODGE NITRO	3.7L V6 226 CID	2014-2018		JEEP CHEROKEE	3.2L V6 3239cc 198 CID
	2008	JEEP GRAND CHEROKEE	4.7L V8 4700cc 287 CID	<b>US8114</b>	2015-2017	CHRYSLER 200	3.6L V6 3604cc 220 CID
	2010	DODGE DAKOTA	3.7L V6 3701cc 226 CID		<b>US8115</b>	2013	CHRYSLER 300
	2010	DODGE RAM 2500	4.7L V8 4701cc 287 CID	2013-2018		DODGE CHALLENGER	5.7L V8 345 CID
	2011	RAM DAKOTA	3.7L V6 226 CID	2013-2018	DODGE CHARGER	5.7L V8 345 CID	
	2011	RAM DAKOTA	4.7L V8 287 CID	2013-2018	DODGE DURANGO	5.7L V8 345 CID	
	2011-2012	DODGE NITRO	3.7L V6 3701cc 226 CID	2013-2018	JEEP GRAND CHEROKEE	5.7L V8 345 CID	
	2011-2012	DODGE NITRO SE	3.7L V6 3701cc 226 CID	2013-2018	JEEP GRAND CHEROKEE	6.4L V8 6424cc 392 CID	
2011-2012	DODGE RAM 2500	4.7L V8 4700cc 287 CID	2014	CHRYSLER 300	6.4L V8 6424cc 392 CID		
2011-2012	RAM 1500	3.7L V6 226 CID	2014-2018	CHRYSLER 300	5.7L V8 345 CID		
2011-2013	JEEP LIBERTY	3.7L V6 3701cc 226 CID	2014-2018	DODGE CHALLENGER	6.4L V8 6424cc 392 CID		
2011-2013	RAM 1500	4.7L V8 287 CID	2014-2018	DODGE CHARGER	6.4L V8 6424cc 392 CID		
2012	DODGE DAKOTA	3.7L V6 3701cc 226 CID	2018	DODGE DURANGO	6.4L V8 6424cc 392 CID		
2013	DODGE RAM 1500	3.7L V6 3701cc 226 CID	<b>US8116</b>	2013-2018	FORD F-150	5.0L V8 4951cc 302 CID	
<b>US7164</b>	1999-2004	JEEP GRAND CHEROKEE		4.0L L6 242 CID	2015-2018	FORD MUSTANG	5.0L V8 4951cc 302 CID
	2000-2006	JEEP WRANGLER	4.0L L6 242 CID	2015-2018	FORD MUSTANG	5.2L V8 5163cc 315 CID	
<b>US7165</b>	2001	CHRYSLER GRAND VOYAGER	3.3L V6 3294cc 201 CID	<b>US8117</b>	2015	FORD EDGE	2.0L L4 1999cc 122 CID
	2001-2002	CHRYSLER VOYAGER	3.3L V6 3294cc 201 CID		2015-2016	FORD MUSTANG	2.3L L4 2300cc 140 CID
	2001-2003	CHRYSLER VOYAGER	3.3L V6 3301cc 201 CID	2015-2018	LINCOLN MKC	2.3L L4 2300cc 140 CID	
	2001-2007	CHRYSLER TOWN & COUNTRY	3.3L V6 3301cc 201 CID	2016	FORD ESCAPE	2.0L L4 1999cc 122 CID	
	2001-2007	CHRYSLER TOWN & COUNTRY	3.8L V6 230 CID	2016	LINCOLN MKC	2.0L L4 1999cc 122 CID	
	2001-2007	DODGE CARAVAN	3.3L V6 3301cc 201 CID	2016-2018	FORD FOCUS	2.3L L4 2300cc 140 CID	
	2001-2007	DODGE GRAND CARAVAN	3.3L V6 3294cc 201 CID	<b>US8118</b>	2015-2017	HONDA CR-V	2.4L L4 2354cc 144 CID
	2001-2007	DODGE GRAND CARAVAN	3.8L V6 230 CID		<b>US8119</b>	2015-2017	HONDA FIT
	2002	CHRYSLER GRAND VOYAGER	3.8L V6 3800cc 232 CID	<b>US8120</b>		2010-2013	LAND ROVER LR4
	2004-2008	CHRYSLER VOYAGER	3.3L V6 3294cc 201 CID		2010-2013	LAND ROVER RANGE ROVER	5.0L V8 5000cc
	<b>US7167</b>	2003-2005	DODGE NEON	2.4L L4 2429cc 148 CID	2010-2013	LAND ROVER RANGE ROVER SPORT	5.0L V8 5000cc
		2003-2009	CHRYSLER PT CRUISER	2.4L L4 2429cc 148 CID	2012	LAND ROVER RANGE ROVER EVOQUE	2.0L L4 1999cc 122 CID
		<b>US7168</b>	2003-2008	DODGE RAM 1500		5.7L V8 345 CID	2014-2016
2003-2008			DODGE RAM 2500	5.7L V8 345 CID	2014-2017	LAND ROVER RANGE ROVER	3.0L V6 2995cc 183 CID
2003-2008		DODGE RAM 3500	5.7L V8 345 CID	2014-2017	LAND ROVER RANGE ROVER	5.0L V8 5000cc 305 CID	
2004-2008		DODGE DURANGO	5.7L V8 345 CID	2014-2017	LAND ROVER RANGE ROVER SPORT	3.0L V6 2995cc 183 CID	
2005-2006		DODGE RAM 4000	5.7L V8 5700cc 350 CID	2014-2017	LAND ROVER RANGE ROVER SPORT	5.0L V8 5000cc 305 CID	
2007-2008	CHRYSLER ASPEN	5.7L V8 345 CID	2017		LAND ROVER DISCOVERY	3.0L V6 2995cc 183 CID	
<b>US7169</b>	1994-2003	DODGE RAM 2500	8.0L V10 7990cc 488 CID	<b>US8121</b>	2008-2015	SMART FORTWO	1.0L L3 1000cc 61 CID
	1994-2003	DODGE RAM 3500	8.0L V10 7990cc 488 CID		<b>US8123</b>	2014-2017	CHEVROLET CORVETTE
<b>US8102</b>	2013-2015	CHEVROLET MALIBU	2.5L L4 2457cc 153 CID	<b>US8124</b>		2014-2017	VOLKSWAGEN PASSAT
	2013-2016	CADILLAC ATS	2.5L L4 2457cc 150 CID		2015-2017	VOLKSWAGEN BEETLE	1.8L L4 1798cc 110 CID
	2013-2017	CADILLAC ATS	2.0L L4 1998cc 122 CID	2015-2017	VOLKSWAGEN BEETLE	2.0L L4 1984cc 121 CID	
	2013-2017	CHEVROLET MALIBU	2.0L L4 1998cc 122 CID	2015-2017	VOLKSWAGEN GOLF	1.8L L4 1798cc 110 CID	
	2014-2017	BUICK REGAL	2.0L L4 1998cc 122 CID	2015-2017	VOLKSWAGEN GOLF SPORTWAGEN	1.8L L4 1798cc 110 CID	
	2014-2017	CADILLAC CTS	2.0L L4 1998cc 122 CID	2015-2017	VOLKSWAGEN GTI	2.0L L4 1984cc 121 CID	
	2014-2017	CHEVROLET IMPALA	2.5L L4 2457cc 153 CID	2015-2017	VOLKSWAGEN JETTA	1.8L L4 1798cc 110 CID	
	2015-2017	CHEVROLET COLORADO	2.5L L4 2457cc 153 CID	2015-2017	VOLKSWAGEN JETTA	2.0L L4 1984cc 121 CID	
	2015-2017	GMC CANYON	2.5L L4 2457cc 153 CID	2017	VOLKSWAGEN GOLF ALLTRACK	1.8L L4 1798cc 110 CID	
	2016	CHEVROLET MALIBU LIMITED	2.5L L4 2457cc 153 CID	<b>US8125</b>	2005-2006	FORD GT	5.4L V8 5409cc 330 CID
	2016-2017	BUICK ENVISION	2.0L L4 1998cc 122 CID		2007-2012	FORD MUSTANG	5.4L V8 5409cc 330 CID
	2016-2017	CADILLAC CT6	2.0L L4 1998cc 122 CID	2013-2014	FORD MUSTANG	5.8L V8 5812cc 355 CID	
	2016-2017	CHEVROLET CAMARO	2.0L L4 1998cc 122 CID	<b>US8134</b>	2011-2014	VOLVO S80	3.2L L6 3192cc
	2017	BUICK ENVISION	2.5L L4 2457cc 153 CID		2011-2015	VOLVO S80	3.0L L6 2953cc
	2017	GMC ACADIA	2.5L L4 2457cc 153 CID		2011-2015	VOLVO XC60	3.2L L6 3192cc
<b>US8103</b>	2013-2017	HONDA ACCORD	2.4L L4 2354cc 144 CID		2011-2015	VOLVO XC70	3.0L L6 2953cc
	2015-2017	ACURA TLX	2.4L L4 2354cc 144 CID		2011-2015	VOLVO XC70	3.2L L6 3192cc
2016-2017	ACURA ILX	2.4L L4 2354cc 144 CID	2011-2016		VOLVO S60	3.0L L6 2953cc	
2016-2017	HONDA CIVIC	2.0L L4 1996cc 122 CID	2011-2016		VOLVO XC60	3.0L L6 2953cc	
<b>US8104</b>	2011-2017	NISSAN JUKE	1.6L L4 1618cc		2013	VOLVO S60	3.0L L6 2953cc 180 CID
	2013-2017	NISSAN SENTRA	1.8L L4 1798cc 110 CID		2015-2016	VOLVO V60	3.0L L6 2953cc
	2017	NISSAN ROGUE SPORT	2.0L L4 1997cc		<b>US8135</b>	2012-2016	BMW 328i
2017	NISSAN SENTRA	1.6L L4 1618cc	2012-2016	BMW 528i		2.0L L4 1997cc 122 CID	
<b>US8105</b>	2013-2017	NISSAN ALTIMA	2.5L L4 2488cc 152 CID	2012-2016	BMW 528i XDRIVE	2.0L L4 1997cc 122 CID	
	2014	NISSAN PATHFINDER	2.5L L4 2488cc 152 CID	2012-2016	BMW Z4	2.0L L4 1997cc 122 CID	
	2014-2017	INFINITI QX60	2.5L L4 2488cc 152 CID	2013-2015	BMW X1	2.0L L4 1997cc 122 CID	
	2014-2017	NISSAN ROGUE	2.5L L4 2488cc 152 CID	2013-2016	BMW 328i XDRIVE	2.0L L4 1997cc 122 CID	
	2016	NISSAN MURANO	2.5L L4 2488cc 152 CID				
<b>US8106</b>	2011-2016	HYUNDAI ELANTRA	1.8L L4 1797cc				
	2012-2017	KIA SOUL	2.0L L4 1999cc 122 CID				
	2013	HYUNDAI ELANTRA COUPE	1.8L L4 1797cc				



USMW	Years	Application	Engine	USMW	Years	Application	Engine	
<b>US8135</b>	2013-2017	<b>BMW X3</b>	2.0L L4 1997cc 122 CID	<b>US8157</b>	2017-2018	<b>FORD F-250 SUPER DUTY</b>	6.7L V8 6651cc 406 CID	
	2014-2016	<b>BMW 228i</b>	2.0L L4 1997cc 122 CID		2017-2018	<b>FORD F-350 SUPER DUTY</b>	6.7L V8 6651cc 406 CID	
	2014-2016	<b>BMW 328i GT XDRIVE</b>	2.0L L4 1997cc 122 CID		2017-2018	<b>FORD F-450 SUPER DUTY</b>	6.7L V8 6651cc 406 CID	
	2014-2016	<b>BMW 428i</b>	2.0L L4 1997cc 122 CID		2017-2018	<b>FORD F-550 SUPER DUTY</b>	6.7L V8 6651cc 406 CID	
	2014-2016	<b>BMW 428i XDRIVE</b>	2.0L L4 1997cc 122 CID		<b>US8158</b>	2016-2017	<b>CHEVROLET VOLT</b>	1.5L L4 1490cc 91 CID
	2015-2016	<b>BMW 228i XDRIVE</b>	2.0L L4 1997cc 122 CID			<b>US8159</b>	2014-2015	<b>CHEVROLET CRUZE</b>
	2015-2016	<b>BMW 428i GRAN COUPE</b>	2.0L L4 1997cc 122 CID		<b>US8160</b>		2016-2018	<b>DODGE DURANGO</b>
	2015-2016	<b>BMW 428i XDRIVE GRAN COUPE</b>	2.0L L4 1997cc 122 CID			2016-2018	<b>JEEP GRAND CHEROKEE</b>	3.6L V6 3604cc 220 CID
	2015-2017	<b>BMW X4</b>	2.0L L4 1997cc 122 CID		<b>US8161</b>	2014-2018	<b>JEEP GRAND CHEROKEE</b>	3.0L V6 2987cc 182 CID
	2016-2017	<b>BMW X5</b>	2.0L L4 1997cc 122 CID			2014-2018	<b>RAM 1500</b>	3.0L V6 2987cc 182 CID
<b>US8136</b>	2012-2017	<b>FIAT 500</b>	1.4L L4 1368cc 83 CID	<b>US8162</b>	2016-2018	<b>FORD TRANSIT-150</b>	3.2L L5 195 CID	
	2013-2016	<b>DODGE DART</b>	1.4L L4 1368cc 83 CID		2016-2018	<b>FORD TRANSIT-250</b>	3.2L L5 195 CID	
	2014	<b>FIAT 500L</b>	1.4L L4 1368cc 83 CID		2016-2018	<b>FORD TRANSIT-350</b>	3.2L L5 195 CID	
	2015-2017	<b>JEEP RENEGADE</b>	1.4L L4 1368cc 83 CID		2016-2018	<b>FORD TRANSIT-350 HD</b>	3.2L L5 195 CID	
	2016-2017	<b>FIAT 500L</b>	1.4L L4 1368cc 83 CID	<b>US8163</b>	2015-2016	<b>HYUNDAI SONATA</b>	2.4L L4 2359cc 144 CID	
	2016-2017	<b>FIAT 500X</b>	1.4L L4 1368cc 83 CID		2015-2017	<b>HYUNDAI SONATA</b>	2.0L L4 1998cc 122 CID	
	2017	<b>FIAT 124 SPIDER</b>	1.4L L4 1368cc 83 CID		2015-2017	<b>HYUNDAI SONATA</b>	2.4L L4 2359cc	
<b>US8137</b>	2012-2014	<b>HONDA CR-V</b>	2.4L L4 2354cc 144 CID	2016-2017	<b>KIA OPTIMA</b>	2.0L L4 1998cc 122 CID		
<b>US8138</b>	2015	<b>HONDA CROSSTOUR</b>	2.4L L4 2354cc 144 CID	2016-2017	<b>KIA OPTIMA</b>	2.4L L4 2359cc		
<b>US8139</b>	2010-2012	<b>SUBARU LEGACY</b>	2.5L H4 2458cc	2016-2017	<b>KIA SORENTO</b>	2.0L L4 1998cc 122 CID		
<b>US8140</b>	2014-2017	<b>RAM 4500</b>	6.4L V8 6424cc 392 CID	2016-2017	<b>KIA SORENTO</b>	2.4L L4 2359cc		
	2014-2017	<b>RAM 5500</b>	6.4L V8 6424cc 392 CID	2017	<b>HYUNDAI SANTA FE SPORT</b>	2.0L L4 1998cc 122 CID		
	2014-2018	<b>RAM 2500</b>	6.4L V8 6424cc 392 CID	2017	<b>HYUNDAI SANTA FE SPORT</b>	2.4L L4 2359cc		
	2014-2018	<b>RAM 3500</b>	6.4L V8 6424cc 392 CID	2017	<b>KIA SPORTAGE</b>	2.0L L4 1998cc 122 CID		
	2017	<b>KIA SPORTAGE</b>	2.4L L4 2359cc	2017	<b>KIA SPORTAGE</b>	2.4L L4 2359cc		
<b>US8141</b>	2015-2017	<b>FORD F-150</b>	2.7L V6 164 CID	<b>US8164</b>	2007-2008	<b>INFINITI G35</b>	3.5L V6 3498cc	
	2016-2018	<b>FORD EDGE</b>	2.7L V6 164 CID		2007-2009	<b>NISSAN 350Z</b>	3.5L V6 3498cc	
	2016-2018	<b>LINCOLN MKX</b>	2.7L V6 164 CID		2008-2012	<b>INFINITI EX35</b>	3.5L V6 3498cc	
	2017	<b>FORD FUSION</b>	2.7L V6 164 CID		2008-2013	<b>INFINITI G37</b>	3.7L V6 3696cc	
	2017-2018	<b>LINCOLN CONTINENTAL</b>	3.0L V6 2956cc 181 CID		2009-2010	<b>INFINITI M35</b>	3.5L V6 3498cc	
	2017-2018	<b>LINCOLN CONTINENTAL</b>	3.0L V6 2956cc 181 CID		2009-2012	<b>INFINITI FX35</b>	3.5L V6 3498cc	
	2017-2018	<b>LINCOLN MKZ</b>	3.0L V6 2956cc 181 CID		2009-2017	<b>NISSAN 370Z</b>	3.7L V6 3696cc	
	2015-2016	<b>FORD F-150</b>	2.7L V6 164 CID		2009-2017	<b>NISSAN GT-R</b>	3.8L V6 3799cc	
	2016	<b>FORD EDGE</b>	2.7L V6 164 CID		2010-2016	<b>NISSAN 370Z</b>	3.7L V6 3696cc 226 CID	
	2016	<b>LINCOLN MKX</b>	2.7L V6 164 CID		2011-2013	<b>INFINITI M37</b>	3.7L V6 3696cc	
<b>US8141P</b>	2015-2016	<b>FORD F-150</b>	2.7L V6 164 CID	2012-2013	<b>INFINITI G37</b>	3.7L V6 3696cc 226 CID		
	2016	<b>FORD EDGE</b>	2.7L V6 164 CID	2012-2013	<b>INFINITI M35H</b>	3.5L V6 3498cc		
	2016	<b>LINCOLN MKX</b>	2.7L V6 164 CID	2012-2013	<b>INFINITI M37</b>	3.7L V6 3696cc 226 CID		
	2017-2018	<b>FORD FUSION</b>	2.7L V6 164 CID	2013	<b>INFINITI EX37</b>	3.7L V6 3696cc		
	<b>US8141P-T</b>	2015-2016	<b>FORD F-150</b>	2.7L V6 164 CID	2013	<b>INFINITI FX37</b>	3.7L V6 3696cc	
		2016	<b>FORD EDGE</b>	2.7L V6 164 CID	2013	<b>INFINITI FX37</b>	3.7L V6 3696cc 226 CID	
		2016	<b>LINCOLN MKX</b>	2.7L V6 164 CID	2014-2015	<b>INFINITI Q50</b>	3.7L V6 3696cc	
		2017-2018	<b>FORD FUSION</b>	2.7L V6 164 CID	2014-2015	<b>INFINITI Q60</b>	3.7L V6 3696cc	
		<b>US8141-T</b>	2015-2017	<b>FORD F-150</b>	2.7L V6 164 CID	2014-2017	<b>INFINITI Q50</b>	3.5L V6 3498cc
			2016-2017	<b>FORD EDGE</b>	2.7L V6 164 CID	2014-2017	<b>INFINITI Q70</b>	3.5L V6 3498cc
2016-2017			<b>LINCOLN MKX</b>	2.7L V6 164 CID	2014-2017	<b>INFINITI Q70</b>	3.7L V6 3696cc	
2017			<b>FORD FUSION</b>	2.7L V6 164 CID	2014-2017	<b>INFINITI Q70</b>	3.7L V6 3696cc	
2017			<b>LINCOLN CONTINENTAL</b>	2.7L V6 164 CID	2014-2017	<b>INFINITI QX50</b>	3.7L V6 3696cc	
2017			<b>LINCOLN CONTINENTAL</b>	3.0L V6 2956cc 181 CID	2014-2017	<b>INFINITI QX70</b>	3.7L V6 3696cc	
2017	<b>LINCOLN CONTINENTAL</b>		3.0L V6 2956cc 181 CID	2015	<b>INFINITI Q40</b>	3.7L V6 3696cc		
2017	<b>LINCOLN MKZ</b>		3.0L V6 2956cc 181 CID	2015-2017	<b>INFINITI Q70L</b>	3.7L V6 3696cc		
<b>US8142</b>	2009-2013		<b>CHEVROLET CORVETTE</b>	6.2L V8 6162cc 376 CID	<b>US8908</b>	1990-1992	<b>DAIHATSU ROCKY</b>	1.6L L4 1589cc
<b>US8142-T</b>	2009-2013		<b>CHEVROLET CORVETTE</b>	6.2L V8 6162cc 376 CID		<b>US8910</b>	2011-2016	<b>LINCOLN MKS</b>
<b>US8143</b>	2015-2018	<b>DODGE ATTITUDE</b>	1.2L L3 1193cc 73 CID	2011-2018	<b>FORD FLEX</b>		3.5L V6 3496cc 213 CID	
<b>US8144</b>	2015-2018	<b>MINI COOPER</b>	1.2L L3 1193cc 73 CID	2011-2018	<b>FORD TAURUS</b>		3.5L V6 3496cc 213 CID	
	2015-2018	<b>MINI COOPER S</b>	1.2L L3 1193cc 73 CID	2011-2018	<b>LINCOLN MKT</b>		3.5L V6 3496cc 213 CID	
	2017-2018	<b>MINI COOPER S</b>	1.2L L3 1193cc 73 CID	2012	<b>FORD FUSION</b>		3.5L V6 3496cc 213 CID	
<b>US8144</b>	2012-2015	<b>HONDA CIVIC</b>	1.5L L4 1497cc	2012	<b>LINCOLN MKZ</b>		3.5L V6 3496cc 213 CID	
	2013-2014	<b>ACURA ILX</b>	1.5L L4 1497cc	2012-2014	<b>FORD EDGE</b>		3.7L V6 3726cc 227 CID	
<b>US8145</b>	2016-2017	<b>HONDA CIVIC</b>	1.5L L4 1497cc	2012-2016	<b>LINCOLN MKS</b>		3.7L V6 3726cc 227 CID	
	2017	<b>HONDA CR-V</b>	1.5L L4 1497cc	2012-2018	<b>FORD EDGE</b>		3.5L V6 3496cc 213 CID	
<b>US8146</b>	2014-2017	<b>FORD FIESTA</b>	1.0L L3 999cc 61 CID	2012-2018	<b>FORD EXPLORER</b>		3.5L V6 3496cc 213 CID	
	2015-2018	<b>FORD FOCUS</b>	1.0L L3 999cc 61 CID	2012-2018	<b>LINCOLN MKT</b>	3.7L V6 3726cc 227 CID		
	2018	<b>FORD ECOSPORT</b>	1.0L L3 999cc 61 CID	2012-2018	<b>LINCOLN MKX</b>	3.7L V6 3726cc 227 CID		
<b>US8147</b>	2016-2017	<b>BUICK ENCORE</b>	1.4L L4 1399cc 85 CID	2013-2016	<b>LINCOLN MKZ</b>	3.7L V6 3726cc 227 CID		
	2016-2017	<b>CHEVROLET CRUZE</b>	1.4L L4 1399cc 85 CID	2013-2018	<b>FORD POLICE INTERCEPTOR SEDAN</b>	3.5L V6 3496cc 213 CID		
	2016-2017	<b>CHEVROLET MALIBU</b>	1.5L L4 1490cc 91 CID	2013-2018	<b>FORD POLICE INTERCEPTOR SEDAN</b>	3.7L V6 3726cc 227 CID		
	2016-2017	<b>CHEVROLET SPARK</b>	1.4L L4 1399cc 85 CID	2013-2018	<b>FORD POLICE INTERCEPTOR UTILITY</b>	3.7L V6 3726cc 227 CID		
	<b>US8148</b>	2016-2017	<b>CADILLAC ATS</b>	3.6L V6 222 CID	2014-2018	<b>FORD POLICE INTERCEPTOR UTILITY</b>	3.5L V6 3496cc 213 CID	
2016-2017		<b>CADILLAC CT6</b>	3.0L V6 182 CID	2017-2018	<b>LINCOLN CONTINENTAL</b>	3.7L V6 3726cc 227 CID		
2016-2017		<b>CADILLAC CT6</b>	3.6L V6 222 CID	1984-1986	<b>AMERICAN MOTORS ALLIANCE</b>	1.7L L4 1700cc 104 CID		
2016-2017		<b>CADILLAC CTS</b>	3.6L V6 222 CID	1984-1986	<b>RENAULT R18</b>	2.0L L4 1995cc 122 CID		
2016-2017		<b>CHEVROLET CAMARO</b>	3.6L V6 222 CID	1985-1986	<b>AMERICAN MOTORS ENCORE</b>	1.7L L4 1700cc 104 CID		
2017		<b>BUICK LACROSSE</b>	3.6L V6 222 CID	2001-2002	<b>RENAULT MEGANE</b>	2.0L L4 2000cc 122 CID		
2017		<b>CADILLAC XT5</b>	3.6L V6 222 CID	2002	<b>RENAULT CLIO</b>	2.0L L4 2000cc 122 CID		
2017		<b>GMC ACADIA</b>	3.6L V6 222 CID	2002	<b>RENAULT SCENIC</b>	2.0L L4 2000cc 122 CID		
<b>US8149</b>		2017	<b>FORD F-150</b>	3.5L V6 3496cc 213 CID	2003-2004	<b>RENAULT MEGANE</b>	2.0L L4 1998cc 122 CID	
		<b>US8150</b>	2016-2017	<b>LEXUS GS350</b>	3.5L V6 3456cc	2003-2004	<b>RENAULT SCENIC</b>	2.0L L4 1998cc 122 CID
	2016-2017		<b>LEXUS RX350</b>	3.5L V6 3456cc	2003-2006	<b>RENAULT CLIO</b>	2.0L L4 1998cc 122 CID	
	2016-2017		<b>LEXUS RX450H</b>	3.5L V6 3456cc	2004-2010	<b>RENAULT MEGANE II</b>	2.0L L4 1998cc 122 CID	
	2017		<b>TOYOTA HIGHLANDER</b>	3.5L V6 3456cc	2005-2008	<b>RENAULT SCENIC II</b>	2.0L L4 1998cc 122 CID	
2017	<b>TOYOTA SIENNA</b>		3.5L V6 3456cc	<b>US8916</b>	2011-2017	<b>FORD F-150</b>	3.5L V6 3496cc 213 CID	
<b>US8151</b>	2017-2018	<b>CHRYSLER PACIFICA</b>	3.6L V6 3604cc 220 CID		2014	<b>FORD F-150</b>	3.7L V6 3726cc 227 CID	
	2011-2015	<b>CHEVROLET VOLT</b>	1.4L L4 1398cc 85 CID		2015-2017	<b>FORD EXPEDITION</b>	3.5L V6 3496cc 213 CID	
<b>US8152</b>	2014-2015	<b>CADILLAC ELR</b>	1.4L L4 1398cc 85 CID		2015-2017	<b>LINCOLN NAVIGATOR</b>	3.5L V6 3496cc 213 CID	
	2017	<b>CHEVROLET COLORADO</b>	3.6L V6 222 CID		2015-2018	<b>FORD TRANSIT-150</b>	3.5L V6 3496cc 213 CID	
<b>US8153</b>	2017	<b>GMC CANYON</b>	3.6L V6 222 CID		2015-2018	<b>FORD TRANSIT-250</b>	3.5L V6 3496cc 213 CID	
	2017	<b>GMC CANYON</b>	3.6L V6 222 CID		<b>US8155</b>	2016-2017	<b>BUICK CASCADA</b>	1.6L L4 1598cc 98 CID
<b>US8154</b>	2016-2017	<b>CHEVROLET COLORADO</b>	2.8L L4 171 CID			2016-2017	<b>CHEVROLET MALIBU</b>	1.8L L4 1796cc 110 CID
	2016-2017	<b>GMC CANYON</b>	2.8L L4 171 CID					
2017	<b>CHEVROLET EXPRESS 2500</b>	2.8L L4 171 CID						
2017	<b>CHEVROLET EXPRESS 3500</b>	2.8L L4 171 CID						
2017	<b>GMC SAVANA 2500</b>	2.8L L4 171 CID						
2017	<b>GMC SAVANA 3500</b>	2.8L L4 171 CID						

WATER PUMPS

USMW	Years	Application	Engine	USMW	Years	Application	Engine	
<b>US8916</b>	2015-2018	FORD TRANSIT-350	3.5L V6 3496cc 213 CID	<b>US8927</b>	2010	NISSAN APRIO	1.6L L4 1598cc 98 CID	
	2015-2018	FORD TRANSIT-350 HD	3.5L V6 3496cc 213 CID		2010	NISSAN PLATINA	1.6L L4 1597cc 97 CID	
	2016-2017	FORD MUSTANG	3.7L V6 3726cc 227 CID		2010	RENAULT KANGOO EXPRESS	1.6L L4 1598cc 98 CID	
	2016-2018	FORD TRANSIT-150	3.7L V6 3726cc 227 CID		2010-2011	RENAULT SANDERO	1.6L L4 1598cc 97 CID	
	2016-2018	FORD TRANSIT-250	3.7L V6 3726cc 227 CID		2010-2011	RENAULT SANDERO	1.6L L4 1598cc 98 CID	
	2016-2018	FORD TRANSIT-350	3.7L V6 3726cc 227 CID		<b>US8928</b>	2004-2010	PONTIAC MATIZ	1.0L L4 995cc 61 CID
2016-2018	FORD TRANSIT-350 HD	3.7L V6 3726cc 227 CID	2007-2009	PONTIAC MONTANA		3.9L V6 3880cc 237 CID		
<b>US8917</b>	1999-2002	DAEWOO LANOS	1.6L L4 1588cc 98 CID	2011-2015		CHEVROLET MATIZ	1.0L L4 995cc 61 CID	
	<b>US8918</b>	2014-2017	CHEVROLET SILVERADO 1500	4.3L V6 262 CID	<b>US8931</b>	2001	FORD FIESTA	1.6L L4 1596cc 97 CID
2014-2017		CHEVROLET SILVERADO 1500	5.3L V8 5328cc 325 CID	2001-2002		FORD COURIER	1.6L L4 1598cc 98 CID	
2014-2017		CHEVROLET SILVERADO 1500	6.2L V8 6162cc 376 CID	2001-2008		FORD KA	1.6L L4 1596cc 97 CID	
2014-2017		GMC SIERRA 1500	4.3L V6 262 CID	2002-2004		FORD FIESTA IKON	1.6L L4 1596cc 97 CID	
2014-2017		GMC SIERRA 1500	5.3L V8 5328cc 325 CID	2003-2007		FORD COURIER	1.6L L4 1600cc 98 CID	
2014-2017		GMC SIERRA 1500	6.2L V8 6162cc 376 CID	2003-2010		FORD FIESTA	1.6L L4 1596cc 97 CID	
2015-2017		CADILLAC ESCALADE	6.2L V8 6162cc 376 CID	2008-2010		FORD COURIER	1.6L L4 1598cc 98 CID	
2015-2017		CADILLAC ESCALADE ESV	6.2L V8 6162cc 376 CID	2011-2012		FORD COURIER	1.6L L4 1600cc 98 CID	
2015-2017		CHEVROLET SUBURBAN	5.3L V8 5328cc 325 CID	2011-2012		FORD FIESTA IKON	1.6L L4 1598cc 98 CID	
2015-2017		CHEVROLET TAHOE	5.3L V8 5328cc 325 CID	2012-2015		FORD FIESTA IKON	1.6L L4 1600cc 98 CID	
2015-2017		GMC YUKON	5.3L V8 5328cc 325 CID	<b>US8932</b>		2004-2006	BUICK RENDEZVOUS	3.6L V6 3564cc 217 CID
2015-2017		GMC YUKON	6.2L V8 6162cc 376 CID		2004-2009	CADILLAC SRX	3.6L V6 3564cc 217 CID	
2015-2017		GMC YUKON XL	5.3L V8 5328cc 325 CID		2004-2013	CADILLAC CTS	3.6L V6 3564cc 217 CID	
2015-2017		GMC YUKON XL	6.2L V8 6162cc 376 CID		2005-2007	CADILLAC CTS	2.8L V6 2792cc 170 CID	
2016-2017		CADILLAC CTS	6.2L V8 6162cc 376 CID		2005-2008	BUICK LACROSSE	3.6L V6 3564cc 217 CID	
2016-2017		CHEVROLET CAMARO	6.2L V8 6162cc 376 CID		2005-2011	CADILLAC STS	3.6L V6 3564cc 217 CID	
<b>US8920</b>		1997-1998	FORD E-350 ECONOLINE		5.4L V8 330 CID	2006-2008	CHEVROLET VECTRA	2.8L V6 2800cc 173 CID
		1997-1999	FORD F-250		4.6L V8 281 CID	2006-2009	SAAB 9-3	2.8L V6 2792cc 170 CID
		1997-1999	FORD F-250		5.4L V8 330 CID	2007-2009	PONTIAC G6	3.6L V6 3564cc 217 CID
		1997-2002	FORD E-150 ECONOLINE		4.6L V8 281 CID	2007-2009	SATURN AURA	3.6L V6 3564cc 217 CID
		1997-2002	FORD E-150 ECONOLINE		5.4L V8 330 CID	2007-2009	SUZUKI XL-7	3.6L V6 3564cc
	1997-2002	FORD E-150 ECONOLINE CLUB WAGON	4.6L V8 281 CID	2007-2010	SATURN OUTLOOK	3.6L V6 3564cc 217 CID		
	1997-2002	FORD E-150 ECONOLINE CLUB WAGON	5.4L V8 330 CID	2007-2013	GMC ACADIA	3.6L V6 3564cc 217 CID		
	1997-2002	FORD E-250 ECONOLINE	5.4L V8 330 CID	2008-2009	CHEVROLET CAPTIVA SPORT	3.6L V6 3564cc 217 CID		
	1997-2002	FORD E-350 ECONOLINE CLUB WAGON	5.4L V8 330 CID	2008-2009	CHEVROLET EQUINOX	3.6L V6 3564cc 217 CID		
	1997-2002	FORD E-350 ECONOLINE CLUB WAGON	5.4L V8 330 CID	2008-2009	PONTIAC G8	3.6L V6 3564cc 217 CID		
1997-2004	FORD EXPEDITION	4.6L V8 281 CID	2008-2009	PONTIAC TORRENT	3.6L V6 3564cc 217 CID			
1997-2006	FORD EXPEDITION	5.4L V8 330 CID	2008-2010	SATURN VUE	3.6L V6 3564cc 217 CID			
1997-2006	FORD F-150	4.6L V8 281 CID	2008-2012	CHEVROLET MALIBU	3.6L V6 3564cc 217 CID			
1997-2006	FORD F-150	5.4L V8 330 CID	2008-2013	BUICK ENCLAVE	3.6L V6 3564cc 217 CID			
1998-2006	LINCOLN NAVIGATOR	5.4L V8 330 CID	2009-2010	SUZUKI GRAND VITARA	3.2L V6 3195cc			
1999-2010	FORD F-250 SUPER DUTY	5.4L V8 330 CID	2009-2013	CHEVROLET TRAVERSE	3.6L V6 3564cc 217 CID			
1999-2010	FORD F-350 SUPER DUTY	5.4L V8 330 CID	2010	BUICK LACROSSE	3.0L V6 182 CID			
1999-2016	FORD E-350 SUPER DUTY	5.4L V8 330 CID	2010-2011	CADILLAC SRX	2.8L V6 2792cc 170 CID			
2000-2005	FORD EXCURSION	5.4L V8 330 CID	2010-2011	CADILLAC SRX	3.0L V6 182 CID			
2002	LINCOLN BLACKWOOD	5.4L V8 330 CID	2010-2011	SAAB 9-5	2.8L V6 2792cc 170 CID			
2002-2010	FORD EXPLORER	4.6L V8 281 CID	2010-2012	CHEVROLET EQUINOX	3.0L V6 182 CID			
2002-2010	MERCURY MOUNTAINEER	4.6L V8 281 CID	2010-2012	GMC TERRAIN	3.0L V6 182 CID			
2003-2005	FORD E-150 CLUB WAGON	4.6L V8 281 CID	2010-2013	BUICK LACROSSE	3.6L V6 3564cc 217 CID			
2003-2005	FORD E-150 CLUB WAGON	5.4L V8 330 CID	2010-2013	CADILLAC CTS	3.0L V6 182 CID			
2003-2005	FORD E-350 CLUB WAGON	5.4L V8 330 CID	2010-2013	CHEVROLET CAMARO	3.6L V6 3564cc 217 CID			
2003-2005	LINCOLN AVIATOR	4.6L V8 281 CID	2011-2012	CHEVROLET CAPTIVA SPORT	3.0L V6 3000cc 183 CID			
2003-2014	FORD E-150	4.6L V8 281 CID	2011-2012	GMC TERRAIN	3.0L V6 2994cc 183 CID			
2003-2014	FORD E-150	5.4L V8 330 CID	2012	CHEVROLET CAPTIVA SPORT	3.0L V6 182 CID			
2003-2014	FORD E-250	4.6L V8 281 CID	2012-2013	CADILLAC SRX	3.6L V6 3564cc 217 CID			
2003-2014	FORD E-250	5.4L V8 330 CID	2012-2013	CHEVROLET CAPRICE	3.6L V6 3564cc 217 CID			
2004	FORD F-150 HERITAGE	4.6L V8 281 CID	2012-2013	CHEVROLET IMPALA	3.6L V6 3564cc 217 CID			
2004	FORD F-150 HERITAGE	5.4L V8 330 CID	2013	CADILLAC ATS	3.6L V6 3564cc 217 CID			
2006	LINCOLN MARK LT	5.4L V8 330 CID	2013	CADILLAC CTS	3.0L V6 2994cc 183 CID			
2007-2010	FORD EXPLORER SPORT TRAC	4.6L V8 281 CID	2013	CADILLAC CTS-V	6.2L V8 6200cc 378 CID			
2009-2010	FORD F-150	4.6L V8 281 CID	2013	CADILLAC XTS	3.6L V6 3564cc 217 CID			
2009-2014	FORD EXPEDITION	5.4L V8 330 CID	2013	CHEVROLET COLORADO	3.6L V6 3600cc 217 CID			
2009-2014	LINCOLN NAVIGATOR	5.4L V8 330 CID	2013	CHEVROLET EQUINOX	3.6L V6 3564cc 217 CID			
2010	FORD F-150	5.4L V8 330 CID	2013	GMC TERRAIN	3.6L V6 3564cc 217 CID			
2014	FORD EXPEDITION	5.4L V8 5408cc 330 CID	2014-2016	CHEVROLET COLORADO	3.6L V6 3564cc 217 CID			
2014-2016	FORD E-450 SUPER DUTY	5.4L V8 330 CID	2014-2016	CHEVROLET IMPALA LIMITED	3.6L V6 3564cc 217 CID			
<b>US8921</b>	2007-2012	RENAULT TRAFIC	1.9L L4 1900cc 114 CID	2015	CHEVROLET CAMARO	3.6L V6 3564cc 217 CID		
	2008-2012	RENAULT TRAFIC	1.9L L4 1870cc 114 CID	2015-2016	BUICK LACROSSE	3.6L V6 3564cc 217 CID		
<b>US8922</b>	2006-2014	DODGE H100	2.5L L4 2476cc 151 CID	2015-2016	CADILLAC SRX	3.6L V6 3564cc 217 CID		
<b>US8925</b>	2004-2008	SUZUKI FORENZA	2.0L L4 2000cc	2015-2016	GMC ACADIA	3.6L V6 3564cc 217 CID		
	2005-2007	SUZUKI RENO	2.0L L4 1998cc	2015-2017	GMC CANYON	3.6L V6 3564cc 217 CID		
	2006-2009	CHEVROLET OPTRA	2.0L L4 2000cc 122 CID	2015-2017	BUICK ENCLAVE	3.6L V6 3564cc 217 CID		
	2008	SUZUKI RENO	2.0L L4 1998cc 122 CID	2015-2017	CADILLAC ATS	3.6L V6 3564cc 217 CID		
	2010	CHEVROLET OPTRA	2.0L L4 1999cc 122 CID	2015-2017	CADILLAC CTS	3.6L V6 3564cc 217 CID		
<b>US8926</b>	1996-1997	BMW 840CI	4.4L V8 4398cc	2015-2017	CADILLAC XTS	3.6L V6 3564cc 217 CID		
	1996-1998	BMW 740IL	4.4L V8 4398cc	2015-2017	CHEVROLET CAPRICE	3.6L V6 3564cc 217 CID		
	1997-1998	BMW 540I	4.4L V8 4398cc	2015-2017	CHEVROLET EQUINOX	3.6L V6 3564cc 217 CID		
	1997-1998	BMW 740I	4.4L V8 4398cc	2015-2017	CHEVROLET IMPALA	3.6L V6 3564cc 217 CID		
	<b>US8927</b>	2002	RENAULT CLIO	1.6L L4 1600cc 98 CID	2015-2017	CHEVROLET TRAVERSE	3.6L V6 3564cc 217 CID	
2002-2010		NISSAN PLATINA	1.6L L4 1598cc 97 CID	2015-2017	GMC TERRAIN	3.6L V6 3564cc 217 CID		
2002-2010		NISSAN PLATINA	1.6L L4 1598cc 98 CID	2017	GMC ACADIA LIMITED	3.6L V6 3564cc 217 CID		
2002-2010		RENAULT CLIO	1.6L L4 1598cc 98 CID	<b>US8933</b>	2000-2003	CHEVROLET ASTRA	1.8L L4 1796cc 110 CID	
2003-2010		RENAULT CLIO	1.6L L4 1598cc 97 CID		2002-2005	CHEVROLET ZAFIRA	1.8L L4 1796cc 109 CID	
2004-2008		RENAULT KANGOO EXPRESS	1.6L L4 1598cc 98 CID	2003	CHEVROLET CORSA	1.4L L4 1389cc 85 CID		
2004-2010		RENAULT KANGOO	1.6L L4 1598cc 97 CID	2007-2008	CHEVROLET ASTRA	1.8L L4 1796cc 110 CID		
2007-2009		RENAULT KANGOO	1.6L L4 1598cc 98 CID	<b>US8934</b>	1998-2000	FORD FIESTA	1.3L L4 1299cc 79 CID	
2008		NISSAN APRIO	1.6L L4 1598cc 98 CID		<b>US8935</b>	2001-2004	DODGE ATOS	1.0L L4 1000cc 61 CID
2008-2009		NISSAN APRIO	1.6L L4 1597cc 97 CID	2005-2012		DODGE ATOS	1.1L L4 1086cc 66 CID	
2008-2010		RENAULT MEGANE II	1.6L L4 1598cc 97 CID	<b>US8936</b>	2000-2004	PEUGEOT 206	1.4L L4 1360cc 83 CID	
2010		NISSAN APRIO	1.6L L4 1598cc 97 CID		2006-2008	PEUGEOT 206	1.4L L4 1360cc 83 CID	
					<b>US8937</b>	2001-2009	PEUGEOT 206	1.6L L4 1587cc 97 CID

USMW	Years	Application	Engine	USMW	Years	Application	Engine
<b>US8937</b>	2004-2009	PEUGEOT PARTNER	1.6L L4 1587cc 97 CID	<b>US8963</b>	2011-2014	FORD LOBO	5.0L V8 5000cc 305 CID
	2007-2009	PEUGEOT GRAND RAID	1.6L L4 1587cc 97 CID		2011-2014	FORD MUSTANG	5.0L V8 4951cc 302 CID
	2008-2010	PEUGEOT 207	1.6L L4 1598cc 98 CID	<b>US8967</b>	2006-2007	NISSAN MICRA	1.4L L4 1386cc 85 CID
<b>US8938</b>	2003-2008	CHEVROLET CORSA	1.8L L4 1796cc 110 CID	<b>US8968</b>	2005	CHRYSLER PACIFICA	3.8L V6 230 CID
	2004-2005	CHEVROLET TORNADO	1.8L L4 1800cc 110 CID	2007-2008	CHRYSLER PACIFICA	3.8L V6 230 CID	
	2004-2008	CHEVROLET MERIVA	1.8L L4 1796cc 110 CID	<b>US8970</b>	2008-2015	SCION XB	2.4L L4 2362cc
	2005-2008	FIAT PALIO	1.8L L4 1796cc 110 CID	<b>US8971</b>	2002	DODGE RAM 4000	5.7L V8 5700cc 350 CID
	2006-2015	CHEVROLET TORNADO	1.8L L4 1796cc 110 CID	2008-2011	DODGE RAM 4000	5.7L V8 5700cc 350 CID	
	2007-2008	FIAT STRADA	1.8L L4 1796cc 110 CID	2010	JEEP COMMANDER	5.7L V8 5654cc 345 CID	
	2008	FIAT IDEA	1.8L L4 1796cc 110 CID	2010-2014	DODGE RAM 2500	5.7L V8 5654cc 345 CID	
	2008-2009	FIAT IDEA ADVENTURE	1.8L L4 1796cc 110 CID	2011-2012	CHRYSLER 300	5.7L V8 345 CID	
	2010	FIAT PALIO	1.8L L4 1796cc 110 CID	2011-2012	DODGE CHARGER	5.7L V8 345 CID	
	2010	FIAT STRADA	1.8L L4 1796cc 110 CID	2011-2012	DODGE DURANGO	5.7L V8 345 CID	
	<b>US8939</b>	2012-2013	DODGE H10	1.1L L4 1100cc 67 CID	2011-2012	JEEP GRAND CHEROKEE	5.7L V8 345 CID
<b>US8940</b>	2005-2008	CHRYSLER 300	5.7L V8 345 CID	2011-2013	DODGE CHALLENGER	5.7L V8 345 CID	
	2005-2008	DODGE MAGNUM	5.7L V8 345 CID	2011-2013	DODGE CHALLENGER	6.4L V8 6424cc 392 CID	
	2005-2008	JEEP GRAND CHEROKEE	5.7L V8 345 CID	2011-2013	JEEP GRAND CHEROKEE	5.7L V8 5654cc 345 CID	
	2005-2010	CHRYSLER 300	6.1L V8 6059cc 370 CID	2012	CHRYSLER 300	6.4L V8 6424cc 392 CID	
	2006-2008	DODGE CHARGER	5.7L V8 345 CID	2012	DODGE CHARGER	6.4L V8 6424cc 392 CID	
	2006-2008	DODGE MAGNUM	6.1L V8 6059cc 370 CID	2012	JEEP GRAND CHEROKEE	6.4L V8 6424cc 392 CID	
	2006-2008	JEEP COMMANDER	5.7L V8 345 CID	2012-2013	DODGE DURANGO	5.7L V8 5654cc 345 CID	
	2006-2010	DODGE CHARGER	6.1L V8 6059cc 370 CID	2012-2014	DODGE RAM 4000	5.7L V8 5654cc 345 CID	
	2006-2010	JEEP GRAND CHEROKEE	6.1L V8 6059cc 370 CID	<b>US8972</b>	1999-2001	HYUNDAI TIBURON	2.0L L4 1997cc
	2008-2010	DODGE CHALLENGER	6.1L V8 6059cc 370 CID	2001-2012	HYUNDAI ELANTRA	2.0L L4 1975cc	
	<b>US8944</b>	1979	FIAT STRADA	1.5L L4 1498cc	2003-2008	HYUNDAI TIBURON	2.0L L4 1975cc
<b>US8945</b>	2007-2008	FIAT PANDA	1.2L L4 1242cc 76 CID	2004-2009	KIA SPECTRA	2.0L L4 1975cc	
	2011-2012	FIAT PANDA	1.2L L4 1242cc 76 CID	2005-2009	HYUNDAI TUCSON	2.0L L4 1975cc	
<b>US8946</b>	2007-2009	FIAT PUNTO	1.4L L4 1368cc 83 CID	2005-2009	KIA SPECTRA5	2.0L L4 1975cc	
<b>US8948</b>	2004	FIAT PALIO	1.6L L4 1596cc 97 CID	2005-2010	KIA SPORTAGE	2.0L L4 1975cc	
	2005-2006	FIAT PALIO	1.8L L4 1796cc 110 CID	2010-2011	KIA SOUL	2.0L L4 1975cc	
<b>US8949</b>	2003-2007	VOLKSWAGEN POLO	1.6L L4 1596cc 97 CID	<b>US8973</b>	2003-2005	RENAULT LAGUNA	3.0L V6 2950cc 180 CID
	2004-2006	SEAT CORDOBA	1.6L L4 1600cc 98 CID	<b>US8974</b>	2001-2002	PEUGEOT 306	1.8L L4 1766cc 107 CID
	2005-2009	SEAT IBIZA	1.6L L4 1600cc 98 CID	<b>US8975</b>	2015-2018	FORD EDGE	2.0L L4 1999cc 122 CID
	2005-2009	VOLKSWAGEN LUPO	1.6L L4 1599cc 98 CID	2015-2018	FORD MUSTANG	2.3L L4 2300cc 140 CID	
	2005-2009	VOLKSWAGEN LUPO	1.6L L4 1600cc 98 CID	2016-2018	FORD EXPLORER	2.3L L4 2300cc 140 CID	
	2007-2009	VOLKSWAGEN CROSSFOX	1.6L L4 1599cc 98 CID	2017-2018	FORD ESCAPE	2.0L L4 1999cc 122 CID	
	2007-2009	VOLKSWAGEN CROSSFOX	1.6L L4 1600cc 98 CID	2017-2018	FORD FUSION	2.0L L4 1999cc 122 CID	
	2007-2009	VOLKSWAGEN SPORTVAN	1.6L L4 1600cc 98 CID	2017-2018	LINCOLN MKC	2.0L L4 1999cc 122 CID	
	2007-2010	VOLKSWAGEN SPORTVAN	1.6L L4 1599cc 98 CID	2017-2018	LINCOLN MKZ	2.0L L4 1999cc 122 CID	
	2008	SEAT LEON	1.4L L4 1390cc 85 CID	<b>US8976</b>	2010	SEAT LEON	1.4L L4 1390cc 85 CID
	2008-2009	SEAT CORDOBA	1.6L L4 1600cc 98 CID	<b>US8977</b>	2008-2009	AUDI A3	1.4L L4 1368cc 83 CID
	2008-2009	SEAT LEON	1.4L L4 1368cc 83 CID	<b>US8978</b>	2008-2010	NISSAN URVAN	3.0L L4 2999cc 182 CID
	2009-2010	VOLKSWAGEN GOL	1.6L L4 1600cc 98 CID	2011	NISSAN URVAN	3.0L L4 3000cc 183 CID	
	2009-2013	VOLKSWAGEN GOL	1.6L L4 1598cc 98 CID	<b>US8979</b>	2009-2010	CHRYSLER 300	5.7L V8 345 CID
	2011	VOLKSWAGEN GOL SEDAN	1.6L L4 1598cc 98 CID	2009-2010	DODGE CHALLENGER	5.7L V8 345 CID	
	2011-2013	VOLKSWAGEN GOL	1.6L L4 1599cc 98 CID	2009-2010	DODGE CHARGER	5.7L V8 345 CID	
	<b>US8951</b>	2005-2006	CHRYSLER PACIFICA	3.5L V6 3497cc 215 CID	2009-2010	JEEP COMMANDER	5.7L V8 345 CID
2005-2008		DODGE MAGNUM	3.5L V6 3497cc 215 CID	2009-2010	JEEP GRAND CHEROKEE	5.7L V8 345 CID	
2005-2010		CHRYSLER 300	3.5L V6 3497cc 215 CID	<b>US8980</b>	2011-2012	FORD EDGE	3.5L V6 3496cc 213 CID
2006-2010		DODGE CHARGER	3.5L V6 3497cc 215 CID	2011-2012	FORD EDGE	3.7L V6 3726cc 227 CID	
2007-2008		CHRYSLER PACIFICA	4.0L V6 3952cc 241 CID	2011-2012	FORD EXPLORER	3.5L V6 3496cc 213 CID	
2007-2009		CHRYSLER CIRRRUS	3.5L V6 3500cc 213 CID	2011-2012	FORD FLEX	3.5L V6 3496cc 213 CID	
2007-2010		CHRYSLER CIRBRING	3.5L V6 3497cc 215 CID	2011-2012	FORD TAURUS	3.5L V6 3496cc 213 CID	
2007-2011		DODGE NITRO	4.0L V6 3952cc 241 CID	2011-2012	LINCOLN MKS	3.7L V6 3726cc 227 CID	
2008-2010		CHRYSLER TOWN & COUNTRY	4.0L V6 3952cc 241 CID	2011-2012	LINCOLN MKT	3.7L V6 3726cc 227 CID	
2008-2010		DODGE AVENGER	3.5L V6 3497cc 215 CID	2011-2012	LINCOLN MKX	3.7L V6 3726cc 227 CID	
2008-2010		DODGE GRAND CARAVAN	4.0L V6 3952cc 241 CID	2012	FORD FUSION	3.5L V6 3496cc 213 CID	
2009-2010		DODGE CHALLENGER	3.5L V6 3497cc 215 CID	2012	LINCOLN MKZ	3.5L V6 3496cc 213 CID	
2009-2010		DODGE JOURNEY	3.5L V6 3497cc 215 CID	<b>US8981</b>	2011	DODGE CHARGER SXT	3.6L V6 3604cc 220 CID
2009-2010		VOLKSWAGEN ROUTAN	4.0L V6 3952cc 241 CID	2011-2014	CHRYSLER 200	3.6L V6 3604cc 220 CID	
2010		CHRYSLER 300	3.5L V6 3497cc 213 CID	2011-2014	DODGE AVENGER	3.6L V6 3604cc 220 CID	
2010		CHRYSLER CIRRRUS	3.5L V6 3518cc 215 CID	2011-2014	VOLKSWAGEN ROUTAN	3.6L V6 3604cc 220 CID	
<b>US8952</b>		2010-2014	SEAT LEON	1.4L L4 1390cc 85 CID	2011-2015	DODGE DURANGO	3.6L V6 3604cc 220 CID
	2012-2013	SEAT IBIZA	1.4L L4 1390cc 85 CID	2011-2015	JEEP GRAND CHEROKEE	3.6L V6 3604cc 220 CID	
	2013	AUDI A3	1.4L L4 1390cc 85 CID	2011-2016	CHRYSLER TOWN & COUNTRY	3.6L V6 3604cc 220 CID	
	2013	SEAT TOLEDO	1.4L L4 1390cc 85 CID	2011-2018	CHRYSLER 300	3.6L V6 3604cc 220 CID	
	2013	VOLKSWAGEN GOLF	1.4L L4 1390cc 85 CID	2011-2018	DODGE CHALLENGER	3.6L V6 3604cc 220 CID	
	2013-2014	VOLKSWAGEN POLO	1.4L L4 1390cc 85 CID	2011-2018	DODGE CHARGER	3.6L V6 3604cc 220 CID	
	2013-2016	VOLKSWAGEN JETTA	1.4L L4 1395cc 85 CID	2011-2018	DODGE GRAND CARAVAN	3.6L V6 3604cc 220 CID	
	2013-2016	VOLKSWAGEN TRUCK TIGUAN	1.4L L4 1390cc 85 CID	2011-2018	DODGE JOURNEY	3.6L V6 3604cc 220 CID	
	2015	SEAT IBIZA	1.4L L4 1390cc 85 CID	2012-2015	RAM C/V	3.6L V6 3604cc 220 CID	
	2015-2016	SEAT TOLEDO	1.4L L4 1390cc 85 CID	2013-2018	RAM 1500	3.6L V6 3604cc 220 CID	
	2015-2016	VOLKSWAGEN GOLF	1.4L L4 1390cc 85 CID	2014	DODGE PROMASTER 1500	3.6L V6 3605cc 220 CID	
	2016	AUDI A1	1.4L L4 1390cc 85 CID	2014	DODGE PROMASTER 2500	3.6L V6 3605cc 220 CID	
	2016	AUDI A3	1.4L L4 1395cc 85 CID	2014	DODGE PROMASTER 3500	3.6L V6 3605cc 220 CID	
	<b>US8954</b>	2000-2005	PEUGEOT 406	2.0L L4 1998cc 122 CID	2014	DODGE RAM 1500	3.6L V6 3600cc 220 CID
		2003-2010	PEUGEOT 307	2.0L L4 1998cc 122 CID	2014-2015	CHRYSLER TOWN & COUNTRY	3.6L V6 3605cc 220 CID
		2004-2009	CADILLAC SRX	4.6L V8 281 CID	2014-2015	DODGE JOURNEY	3.6L V6 3605cc 220 CID
	<b>US8955</b>	2004-2009	CADILLAC XLR	4.6L V8 281 CID	2014-2018	RAM PROMASTER 1500	3.6L V6 3604cc 220 CID
2005-2010		CADILLAC STS	4.6L V8 281 CID	2014-2018	RAM PROMASTER 2500	3.6L V6 3604cc 220 CID	
2006-2009		CADILLAC STS	4.4L V8 4371cc 267 CID	2014-2018	RAM PROMASTER 3500	3.6L V6 3604cc 220 CID	
2006-2009		CADILLAC XLR	4.4L V8 4371cc 267 CID	2015	DODGE RAM 1500	3.6L V6 3605cc 220 CID	
2006-2011		BUICK LUCERNE	4.6L V8 281 CID	2015-2016	CHRYSLER 200C	3.6L V6 3605cc 220 CID	
<b>US8956</b>	2006-2011	CADILLAC DTS	4.6L V8 281 CID	<b>US8982</b>	2011-2014	HYUNDAI SONATA	2.4L L4 2359cc
<b>US8959</b>	2001-2002	SEAT CORDOBA	1.6L L4 1600cc 98 CID	2011-2015	KIA OPTIMA	2.4L L4 2359cc	
	2002	SEAT IBIZA	1.6L L4 1600cc 98 CID	2011-2016	KIA SPORTAGE	2.4L L4 2359cc	
<b>US8960</b>	2007-2011	JEEP WRANGLER	3.8L V6 3778cc 231 CID	2012-2013	HYUNDAI TUCSON	2.0L L4 1975cc	
<b>US8963</b>	2011-2013	FORD F-150	5.0L V8 4951cc 302 CID	2012-2015	HYUNDAI TUCSON	2.4L L4 2359cc	
	2011-2014	FORD F-150	5.0L V8 5000cc 305 CID	2012-2015	KIA SORENTO	2.4L L4 2359cc	

WATER PUMPS





# WATER PUMP BUYERS GUIDE



USMW	Years	Application	Engine	USMW	Years	Application	Engine
US8982	2014-2016	HYUNDAI SANTA FE SPORT	2.4L L4 2359cc	US9031	1978-1981	NISSAN 510	2.0L L4 1952cc
US8983	2010-2014	HONDA INSIGHT	1.3L L4 1339cc	1980	NISSAN 720	2.0L L4 1952cc	
	2011-2016	HONDA CR-Z	1.5L L4 1497cc 91 CID	1981-1983	NISSAN 720	2.2L L4 2187cc	
US8984	2011-2015	CHEVROLET SPARK	1.2L L4 1200cc 73 CID	1982-1983	NISSAN 200SX	2.2L L4 2187cc	
	2012-2014	CHEVROLET SPARK	1.2L L4 1206cc 74 CID	1983-1986	NISSAN 720	2.0L L4 1952cc	
US8984-2	2012-2014	CHEVROLET SPARK	1.2L L4 1206cc 74 CID	1983-1986	NISSAN 720	2.4L L4 2389cc	
US8985	2000-2001	MERCEDES-BENZ A160	1.6L L4 1587cc 97 CID	1984-1988	NISSAN 200SX	2.0L L4 1974cc	
	2002-2005	MERCEDES-BENZ A160	1.6L L4 1598cc 98 CID	1986-1989	NISSAN D21	2.4L L4 2389cc	
US8987	2006-2014	FORD TRANSIT	2.2L L4 2198cc 125 CID	1987	NISSAN PATHFINDER	2.4L L4 2389cc	
US8990	2002-2005	BMW 745LI	4.4L V8 4398cc	US9033	1975-1977	HONDA CIVIC	1.2L L4 1237cc
	2004-2005	BMW 545I	4.4L V8 4398cc	US9034	1975-1979	HONDA CIVIC	1.5L L4 1487cc
	2004-2005	BMW 645CI	4.4L V8 4398cc	1976-1978	HONDA ACCORD	1.6L L4 1599cc	
	2004-2005	BMW 745I	4.4L V8 4398cc	1979	HONDA ACCORD	1.8L L4 1751cc	
	2004-2006	BMW X5	4.4L V8 4398cc	1979	HONDA PRELUDE	1.8L L4 1751cc	
	2004-2006	BMW X5	4.8L V8 4837cc	US9035	1980-1983	HONDA CIVIC	1.5L L4 1487cc
	2007-2008	BMW ALPINA B7	4.4L V8 4398cc	1982	HONDA PRELUDE	1.8L L4 1751cc	
US8996	2010	SEAT IBIZA	1.6L L4 1600cc 98 CID	1982-1983	HONDA ACCORD	1.8L L4 1751cc	
US8998	2008-2011	NISSAN CABSTAR	2.5L L4 2488cc 151 CID	US9040N	1982-1986	TOYOTA CELICA	2.8L L6 2754cc
	2008-2011	NISSAN NP300	2.5L L4 2488cc 151 CID	1983-1988	TOYOTA CRESSIDA	2.8L L6 2754cc	
US8999	2013-2015	CHEVROLET SPARK	1.2L L4 1249cc 76 CID	US9041	1982	NISSAN 310	1.5L L4 1488cc
US9003	1974	FIAT 124	1.6L L4 1593cc	1982-1983	NISSAN SENTRA	1.5L L4 1488cc	
	1974-1978	FIAT 124	1.8L L4 1756cc	1983	NISSAN PULSAR	1.6L L4 1597cc	
	1975-1978	FIAT 131	1.8L L4 1756cc	1983-1984	NISSAN PULSAR NX	1.5L L4 1488cc	
	1978-1981	FIAT BRAVA	2.0L L4 1995cc	1983-1985	NISSAN SENTRA	1.6L L4 1597cc	
	1979-1982	FIAT 124	2.0L L4 1995cc	1983-1988	NISSAN PULSAR NX	1.6L L4 1597cc	
US9005	1975	TOYOTA CORONA	2.2L L4 2189cc	1984-1985	NISSAN TSURU	1.5L L4 1487cc 91 CID	
	1975	TOYOTA PICKUP	2.2L L4 2189cc	1986-1987	NISSAN SENTRA	1.6L L4 1597cc 97 CID	
US9008	1975-1976	NISSAN 610	2.0L L4 1952cc	1987-1988	NISSAN SENTRA	1.6L L4 1597cc	
	1975-1977	NISSAN 710	2.0L L4 1952cc	US9043N	1980-1983	HONDA CIVIC	1.3L L4 1335cc
	1975-1979	NISSAN 620	2.0L L4 1952cc	US9044	1983-1986	NISSAN SENTRA	1.7L L4 1688cc
	1978-1981	NISSAN 510	2.0L L4 1952cc	US9045	1981-1988	TOYOTA TERCEL	1.5L L4 1452cc
	1980	NISSAN 720	2.0L L4 1952cc	US9046	1984-1987	TOYOTA COROLLA	1.6L L4 1587cc
US9009	1970-1983	NISSAN PICKUP	1.6L L4 1600cc 98 CID	US9047	2008-2010	VOLKSWAGEN JETTA	2.0L L4 1984cc 121 CID
	1973-1984	NISSAN SEDAN	1.6L L4 1597cc 97 CID	2008-2010	VOLKSWAGEN PASSAT	2.0L L4 1984cc 121 CID	
	1973-1984	NISSAN STATION WAGON	1.6L L4 1597cc 97 CID	2008-2011	VOLKSWAGEN GTI	2.0L L4 1984cc 121 CID	
	1980	NISSAN 720	2.0L L4 1952cc	2008-2013	AUDI A3	2.0L L4 1984cc 121 CID	
	1981-1983	NISSAN 720	2.2L L4 2187cc	2009	AUDI TT	2.0L L4 1984cc 121 CID	
US9010	1975-1978	NISSAN B210	1.4L L4 1393cc 85 CID	2009-2013	AUDI A3 QUATTRO	2.0L L4 1984cc 121 CID	
	1980	NISSAN 310	1.4L L4 1393cc 85 CID	2009-2015	AUDI TT QUATTRO	2.0L L4 1984cc 121 CID	
	1981	NISSAN 310	1.5L L4 1488cc	2009-2016	AUDI A4	2.0L L4 1984cc 121 CID	
US9011	1975-1978	NISSAN 280Z	2.8L L6 2753cc	2009-2016	AUDI A4 QUATTRO	2.0L L4 1984cc 121 CID	
	1977-1981	NISSAN 810	2.4L L6 2393cc	2009-2016	VOLKSWAGEN EOS	2.0L L4 1984cc 121 CID	
	1979-1983	NISSAN 280ZX	2.8L L6 2753cc	2009-2017	VOLKSWAGEN CC	2.0L L4 1984cc 121 CID	
	1981	NISSAN 810	2.8L L6 2793cc	2009-2017	VOLKSWAGEN TIGUAN	2.0L L4 1984cc 121 CID	
	1982-1983	NISSAN MAXIMA	2.8L L6 2793cc	2010-2014	AUDI A5	2.0L L4 1984cc 121 CID	
	1982-1984	NISSAN MAXIMA	2.4L L6 2393cc	2010-2017	AUDI A5 QUATTRO	2.0L L4 1984cc 121 CID	
US9012	1975-1976	TOYOTA COROLLA	1.6L L4 1588cc	2011-2017	AUDI Q5	2.0L L4 1984cc 121 CID	
US9015	1978-1979	TOYOTA COROLLA	1.2L L4 1166cc	2012-2013	VOLKSWAGEN BEETLE	2.0L L4 1984cc 121 CID	
	1981-1982	TOYOTA STARLET	1.3L L4 1290cc	2012-2013	VOLKSWAGEN JETTA	2.0L L4 1984cc 121 CID	
US9016	1976	TOYOTA COROLLA	1.6L L4 1588cc	2012-2015	AUDI A6	2.0L L4 1984cc 121 CID	
US9017	1978-1980	TOYOTA CELICA	2.2L L4 2189cc	2013-2014	VOLKSWAGEN GTI	2.0L L4 1984cc 121 CID	
	1978-1980	TOYOTA CORONA	2.2L L4 2189cc	2013-2015	AUDI A6 QUATTRO	2.0L L4 1984cc 121 CID	
	1978-1980	TOYOTA PICKUP	2.2L L4 2189cc	2013-2016	AUDI ALLROAD	2.0L L4 1984cc 121 CID	
	1981-1982	TOYOTA CORONA	2.4L L4 2366cc	2015-2017	AUDI Q3	2.0L L4 1984cc 121 CID	
	1981-1984	TOYOTA CELICA	2.4L L4 2366cc	2015-2017	AUDI Q3 QUATTRO	2.0L L4 1984cc 121 CID	
	1981-1984	TOYOTA PICKUP	2.4L L4 2366cc	US9047-2	2008-2010	VOLKSWAGEN JETTA	2.0L L4 1984cc 121 CID
	1984	TOYOTA 4RUNNER	2.4L L4 2366cc	2008-2010	VOLKSWAGEN PASSAT	2.0L L4 1984cc 121 CID	
US9018	1977-1979	TOYOTA COROLLA	1.6L L4 1588cc	2008-2011	VOLKSWAGEN GTI	2.0L L4 1984cc 121 CID	
	1980-1982	TOYOTA COROLLA	1.8L L4 1770cc	2008-2013	AUDI A3	2.0L L4 1984cc 121 CID	
US9020	1977-1978	MAZDA GLC	1.3L L4 1272cc	2009	AUDI TT	2.0L L4 1984cc 121 CID	
	1979-1980	MAZDA GLC	1.4L L4 1415cc	2009-2013	AUDI A3 QUATTRO	2.0L L4 1984cc 121 CID	
	1981-1983	MAZDA GLC	1.5L L4 1490cc	2009-2015	AUDI TT QUATTRO	2.0L L4 1984cc 121 CID	
US9021	1977	TOYOTA COROLLA	1.2L L4 1166cc	2009-2016	AUDI A4	2.0L L4 1984cc 121 CID	
US9025	1980	SUBARU BRAT	1.6L H4 1595cc	2009-2016	AUDI A4 QUATTRO	2.0L L4 1984cc 121 CID	
	1980	SUBARU GL	1.6L H4 1595cc	2009-2016	VOLKSWAGEN EOS	2.0L L4 1984cc 121 CID	
	1980	SUBARU GLF	1.6L H4 1595cc	2009-2017	VOLKSWAGEN CC	2.0L L4 1984cc 121 CID	
	1980-1982	SUBARU GLF	1.8L H4 1781cc	2009-2017	VOLKSWAGEN TIGUAN	2.0L L4 1984cc 121 CID	
	1980-1984	SUBARU DL	1.6L H4 1595cc	2010-2014	AUDI A5	2.0L L4 1984cc 121 CID	
	1980-1984	SUBARU DL	1.8L H4 1781cc	2010-2017	AUDI A5 QUATTRO	2.0L L4 1984cc 121 CID	
	1980-1984	SUBARU DL	1.8L H4 1781cc	2011-2017	AUDI Q5	2.0L L4 1984cc 121 CID	
	1980-1987	SUBARU BRAT	1.8L H4 1781cc	2012-2013	VOLKSWAGEN BEETLE	2.0L L4 1984cc 121 CID	
	1980-1987	SUBARU STANDARD	1.6L H4 1595cc	2012-2013	VOLKSWAGEN JETTA	2.0L L4 1984cc 121 CID	
	1981-1982	SUBARU STANDARD	1.8L H4 1781cc	2012-2015	AUDI A6	2.0L L4 1984cc 121 CID	
	1986-1987	SUBARU GL	1.6L H4 1595cc	2013-2014	VOLKSWAGEN GTI	2.0L L4 1984cc 121 CID	
US9026	1975-1978	NISSAN B210	1.4L L4 1393cc 85 CID	2013-2015	AUDI A6 QUATTRO	2.0L L4 1984cc 121 CID	
	1979-1982	NISSAN 210	1.4L L4 1393cc 85 CID	2013-2016	AUDI ALLROAD	2.0L L4 1984cc 121 CID	
	1980-1982	NISSAN 210	1.2L L4 1237cc	2015-2017	AUDI Q3	2.0L L4 1984cc 121 CID	
	1980-1982	NISSAN 210	1.5L L4 1488cc	2015-2017	AUDI Q3 QUATTRO	2.0L L4 1984cc 121 CID	
US9027	1975-1977	TOYOTA CELICA	2.2L L4 2189cc	US9048	1983-1986	TOYOTA CAMRY	2.0L L4 1995cc
	1976-1977	TOYOTA CORONA	2.2L L4 2189cc	1986	TOYOTA CELICA	2.0L L4 1995cc	
	1976-1977	TOYOTA PICKUP	2.2L L4 2189cc	1986	TOYOTA CELICA	2.0L L4 1998cc	
US9028	1980	TOYOTA TERCEL	1.5L L4 1452cc	US9049	1976-1984	VOLVO 242	2.1L L4 2127cc
US9029	1980-1981	HONDA ACCORD	1.8L L4 1751cc	1976-1985	VOLVO 244	2.1L L4 2127cc	
	1980-1981	HONDA PRELUDE	1.8L L4 1751cc	1976-1985	VOLVO 245	2.1L L4 2127cc	
US9031	1974	NISSAN 610	2.0L L4 1952cc 119 CID	1983-1984	VOLVO 242	2.3L L4 2316cc	
	1975-1976	NISSAN 610	2.0L L4 1952cc	1983-1984	VOLVO 244	2.3L L4 2316cc	
	1975-1977	NISSAN 710	2.0L L4 1952cc	1983-1984	VOLVO 245	2.3L L4 2316cc	
	1975-1979	NISSAN 620	2.0L L4 1952cc	1984	VOLVO 760	2.3L L4 2316cc	
	1977-1981	NISSAN 200SX	2.0L L4 1952cc	US9050	1981-1985	MAZDA GLC	1.5L L4 1490cc

USMW	Years	Application	Engine	USMW	Years	Application	Engine		
<b>US9052</b>	1980-1983	AUDI 4000	2.2L L5 2144cc	<b>US9065</b>	1995-2002	VOLKSWAGEN CABRIO	2.0L L4 1984cc 121 CID		
	1980-1985	AUDI 5000	2.2L L5 2144cc		1996-1997	VOLKSWAGEN PASSAT	1.9L L4 1896cc 116 CID		
	1981-1984	AUDI COUPE	2.2L L5 2144cc		1997-1999	VOLKSWAGEN JETTA	1.9L L4 1896cc 116 CID		
	1983-1984	VOLKSWAGEN QUANTUM	2.2L L5 2144cc		1998-1999	VOLKSWAGEN GOLF	1.8L L4 1781cc 109 CID		
	1983-1985	AUDI QUATTRO	2.2L L5 2144cc		1998-2001	VOLKSWAGEN COMBI	1.8L L4 1780cc 108 CID		
	1984-1987	AUDI 4000 QUATTRO	2.2L L5 2226cc		1998-2001	VOLKSWAGEN DERBY	1.8L L4 1780cc 108 CID		
	1984-1987	AUDI COUPE	2.2L L5 2226cc		1998-2001	VOLKSWAGEN PANEL	1.8L L4 1780cc 108 CID		
	1985-1988	AUDI 5000	2.2L L5 2226cc		1998-2002	VOLKSWAGEN POINTER	1.8L L4 1780cc 108 CID		
	1985-1988	VOLKSWAGEN QUANTUM	2.2L L5 2226cc		2002-2009	VOLKSWAGEN DERBY	1.8L L4 1781cc 109 CID		
	1986-1988	AUDI 5000 QUATTRO	2.2L L5 2226cc		2003	VOLKSWAGEN VAN	1.8L L4 1781cc 109 CID		
	1987	AUDI COUPE	2.3L L5 2309cc		2003-2010	VOLKSWAGEN POINTER	1.8L L4 1781cc 109 CID		
	1987-1988	AUDI 5000	2.3L L5 2309cc		<b>US9065-2</b>	1981-1982	VOLKSWAGEN RABBIT PICKUP	1.7L L4 1715cc	
	1987-1988	AUDI 5000 QUATTRO	2.3L L5 2309cc			1981-1983	AUDI 4000	1.7L L4 1715cc	
	1988	AUDI 80 QUATTRO	2.3L L5 2309cc			1981-1983	VOLKSWAGEN RABBIT CONVERTIBLE	1.7L L4 1715cc	
	1988	AUDI 90	2.3L L5 2309cc			1981-1983	VOLKSWAGEN RABBIT PICKUP	1.6L L4 1588cc 97 CID	
	1988	AUDI 90 QUATTRO	2.3L L5 2309cc			1981-1983	VOLKSWAGEN SCIROCCO	1.7L L4 1715cc	
	1989	AUDI 200 QUATTRO	2.2L L5 2226cc			1981-1984	VOLKSWAGEN JETTA	1.7L L4 1715cc	
	<b>US9053</b>	1975-1977	MAZDA ROTARY PICKUP			1.3L R2 1308cc	1981-1984	VOLKSWAGEN RABBIT	1.7L L4 1715cc
		1975-1978	MAZDA RX-3			1.1L R2 1146cc	1982-1983	AUDI 4000	1.6L L4 1588cc 97 CID
		1975-1978	MAZDA RX-4			1.3L R2 1308cc	1982-1983	VOLKSWAGEN QUANTUM	1.7L L4 1715cc
1976-1978		MAZDA COSMO	1.3L R2 1308cc	1982-1985		VOLKSWAGEN QUANTUM	1.6L L4 1588cc 97 CID		
1979		MAZDA RX-7	1.1L R2 1146cc	1982-1987		VOLKSWAGEN JETTA	1.6L L4 1588cc 97 CID		
1985		MAZDA RX-7	1.1L R2 1146cc	1983-1984		VOLKSWAGEN RABBIT	1.6L L4 1588cc 97 CID		
1985		MAZDA RX-7	1.3L R2 1308cc	1983-1984		VOLKSWAGEN RABBIT	1.8L L4 1780cc		
<b>US9056</b>	1983-1987	HONDA PRELUDE	1.8L L4 1829cc	1984-1985		VOLKSWAGEN QUANTUM	1.8L L4 1780cc		
	1984-1985	HONDA ACCORD	1.8L L4 1829cc	1984-1987		AUDI 4000	1.8L L4 1780cc		
<b>US9057</b>	1983-1992	TOYOTA COROLLA	1.6L L4 1587cc	1984-1988		VOLKSWAGEN SCIROCCO	1.8L L4 1780cc		
	1985-1988	CHEVROLET NOVA	1.6L L4 1588cc 98 CID	1984-1992		VOLKSWAGEN JETTA	1.8L L4 1780cc		
	1989	GEO PRIZM	1.6L L4 1588cc 98 CID	1985-1988		VOLKSWAGEN GOLF	1.6L L4 1588cc 97 CID		
	1990-1992	GEO PRIZM	1.6L L4 1587cc	1985-1992		VOLKSWAGEN GOLF	1.8L L4 1780cc		
	1990-1993	TOYOTA CELICA	1.6L L4 1587cc	1985-1993		VOLKSWAGEN CABRIOLET	1.8L L4 1780cc		
<b>US9058</b>	1984-1989	NISSAN 300ZX	3.0L V6 2960cc	1987-1993	VOLKSWAGEN FOX	1.8L L4 1780cc			
	1986-1989	NISSAN D21	3.0L V6 2960cc	1988	AUDI 90	2.0L L4 1983cc			
	1987-1988	NISSAN 200SX	3.0L V6 2960cc 181 CID	1988-1990	AUDI 80	2.0L L4 1983cc			
	1990-1992	INFINITI M30	3.0L V6 2960cc 181 CID	1989-1992	VOLKSWAGEN JETTA	1.6L L4 1588cc 97 CID			
	1990-1994	NISSAN D21	3.0L V6 2960cc 181 CID	1990-1992	VOLKSWAGEN CORRADO	1.8L L4 1780cc			
	1995	NISSAN PICKUP	3.0L V6 2960cc 181 CID	1990-1993	VOLKSWAGEN PASSAT	2.0L L4 1984cc 121 CID			
<b>US9059</b>	1984-1985	TOYOTA COROLLA	1.8L L4 1839cc	1990-1999	VOLKSWAGEN GOLF	2.0L L4 1984cc 121 CID			
	1984-1986	TOYOTA CAMRY	1.8L L4 1839cc	1990-1999	VOLKSWAGEN JETTA	2.0L L4 1984cc 121 CID			
	1986	TOYOTA CAMRY	2.0L L4 1974cc	1995-1996	VOLKSWAGEN PASSAT	2.0L L4 1984cc 121 CID			
<b>US9060</b>	1983	MAZDA 626	2.0L L4 1970cc	1995-2002	VOLKSWAGEN CABRIO	2.0L L4 1984cc 121 CID			
	1984-1985	MAZDA 626	2.0L L4 1998cc 122 CID	1996-1997	VOLKSWAGEN PASSAT	1.9L L4 1896cc 116 CID			
<b>US9061</b>	1983-1985	VOLKSWAGEN VANAGON	1.9L H4 1915cc	1997-1999	VOLKSWAGEN JETTA	1.9L L4 1896cc 116 CID			
<b>US9063</b>	1981-1984	NISSAN PICKUP	1.8L L4 1800cc 110 CID	<b>US9066</b>	1975	VOLKSWAGEN DASHER	1.5L L4 1471cc		
	1982-1984	NISSAN SEDAN	1.8L L4 1750cc 107 CID		1975	VOLKSWAGEN RABBIT	1.5L L4 1471cc		
	1982-1984	NISSAN STATION WAGON	1.8L L4 1750cc 107 CID		1975	VOLKSWAGEN SCIROCCO	1.5L L4 1471cc		
	1982-1986	NISSAN SAKURA	1.8L L4 1750cc 107 CID		1975-1979	AUDI FOX	1.6L L4 1588cc 97 CID		
	1984-1986	NISSAN 200SX	1.8L L4 1809cc		1976-1977	VOLKSWAGEN RABBIT	1.6L L4 1588cc 97 CID		
	1984-1988	NISSAN 200SX	2.0L L4 1974cc		1976-1977	VOLKSWAGEN SCIROCCO	1.6L L4 1588cc 97 CID		
	1987	NISSAN PULSAR NX	1.6L L4 1597cc		1976-1981	VOLKSWAGEN DASHER	1.6L L4 1588cc 97 CID		
	<b>US9064</b>	1983-1984	TOYOTA STARLET		1.3L L4 1290cc	1977-1979	VOLKSWAGEN CARIBE	1.6L L4 1588cc 97 CID	
	<b>US9065</b>	1981-1982	VOLKSWAGEN RABBIT PICKUP		1.7L L4 1715cc	1977-1980	VOLKSWAGEN CARIBE	1.6L L4 1600cc 98 CID	
		1981-1983	AUDI 4000		1.7L L4 1715cc	1977-1980	VOLKSWAGEN RABBIT	1.5L L4 1471cc	
	1981-1983	VOLKSWAGEN RABBIT CONVERTIBLE	1.7L L4 1715cc	1978	VOLKSWAGEN SCIROCCO	1.5L L4 1457cc			
	1981-1983	VOLKSWAGEN RABBIT PICKUP	1.6L L4 1588cc 97 CID	1978-1980	VOLKSWAGEN RABBIT	1.5L L4 1457cc			
	1981-1983	VOLKSWAGEN SCIROCCO	1.7L L4 1715cc	1979-1980	VOLKSWAGEN DASHER	1.5L L4 1471cc			
	1981-1984	VOLKSWAGEN JETTA	1.7L L4 1715cc	1979-1980	VOLKSWAGEN SCIROCCO	1.6L L4 1588cc 97 CID			
	1981-1984	VOLKSWAGEN RABBIT	1.7L L4 1715cc	1980	AUDI 4000	1.6L L4 1588cc 97 CID			
	1981-1986	VOLKSWAGEN CARIBE	1.7L L4 1700cc 104 CID	1980	VOLKSWAGEN RABBIT CONVERTIBLE	1.6L L4 1588cc 97 CID			
	1982-1983	AUDI 4000	1.6L L4 1588cc 97 CID	1980	VOLKSWAGEN RABBIT PICKUP	1.5L L4 1457cc			
	1982-1983	VOLKSWAGEN QUANTUM	1.7L L4 1715cc	1980-1982	VOLKSWAGEN JETTA	1.6L L4 1588cc 97 CID			
	1982-1985	VOLKSWAGEN QUANTUM	1.6L L4 1588cc 97 CID	1980-1982	VOLKSWAGEN RABBIT PICKUP	1.6L L4 1588cc 97 CID			
	1982-1986	VOLKSWAGEN ATLANTIC	1.7L L4 1700cc 104 CID	1980-1983	VOLKSWAGEN RABBIT	1.6L L4 1588cc 97 CID			
	1982-1987	VOLKSWAGEN JETTA	1.6L L4 1588cc 97 CID	1981	AUDI 4000	1.7L L4 1715cc			
	1983-1984	VOLKSWAGEN RABBIT	1.6L L4 1588cc 97 CID	1981	VOLKSWAGEN ATLANTIC	1.7L L4 1700cc 104 CID			
	1983-1984	VOLKSWAGEN RABBIT	1.8L L4 1780cc	1981	VOLKSWAGEN RABBIT CONVERTIBLE	1.7L L4 1715cc			
	1984-1985	VOLKSWAGEN QUANTUM	1.8L L4 1780cc	1981	VOLKSWAGEN SCIROCCO	1.7L L4 1715cc			
	1984-1987	AUDI 4000	1.8L L4 1780cc	1981-1983	VOLKSWAGEN RABBIT PICKUP	1.7L L4 1715cc			
	1984-1987	VOLKSWAGEN ATLANTIC	1.8L L4 1800cc 110 CID	1981-1984	VOLKSWAGEN RABBIT	1.7L L4 1715cc			
	1984-1988	VOLKSWAGEN SCIROCCO	1.8L L4 1780cc	1984	VOLKSWAGEN CARIBE	1.8L L4 1800cc 110 CID			
	1984-1992	VOLKSWAGEN JETTA	1.8L L4 1780cc	1998-1999	VOLKSWAGEN JETTA	1.8L L4 1780cc 108 CID			
	1985-1987	VOLKSWAGEN CARIBE	1.8L L4 1800cc 110 CID	1999-2002	VOLKSWAGEN POINTER	1.8L L4 1780cc 108 CID			
	1985-1988	VOLKSWAGEN GOLF	1.6L L4 1588cc 97 CID	<b>US9067</b>	1984-1985	MAZDA 626	2.0L L4 1998cc 122 CID		
	1985-1992	VOLKSWAGEN GOLF	1.8L L4 1780cc		1984-1986	FORD TEMPO	2.0L L4 1989cc 122 CID		
	1985-1993	VOLKSWAGEN CABRIOLET	1.8L L4 1780cc		1984-1986	MERCURY TOPAZ	2.0L L4 1989cc 122 CID		
	1987-1993	VOLKSWAGEN FOX	1.8L L4 1780cc		1984-1987	FORD ESCORT	2.0L L4 1989cc 122 CID		
	1987-1997	VOLKSWAGEN GOLF	1.8L L4 1800cc 110 CID		1984-1987	MERCURY LYNX	2.0L L4 1989cc 122 CID		
	1987-1997	VOLKSWAGEN JETTA	1.8L L4 1800cc 110 CID		<b>US9068</b>	1985	VOLVO 745	2.3L L4 2316cc	
	1988	AUDI 90	2.0L L4 1983cc			1985-1989	VOLVO 244	2.3L L4 2316cc	
	1988-1990	AUDI 80	2.0L L4 1983cc			1985-1989	VOLVO 245	2.3L L4 2316cc	
	1988-1997	VOLKSWAGEN PANEL	1.8L L4 1800cc 110 CID			1985-1990	VOLVO 760	2.3L L4 2316cc	
	1989-1992	VOLKSWAGEN JETTA	1.6L L4 1588cc 97 CID			1985-1992	VOLVO 740	2.3L L4 2316cc	
	1989-1997	VOLKSWAGEN COMBI	1.8L L4 1800cc 110 CID	1989-1991		VOLVO 780	2.3L L4 2316cc		
	1990-1992	VOLKSWAGEN CORRADO	1.8L L4 1780cc	1990-1993		VOLVO 240	2.3L L4 2316cc		
	1990-1993	VOLKSWAGEN PASSAT	2.0L L4 1984cc 121 CID	1991-1995		VOLVO 940	2.3L L4 2316cc		
	1990-1999	VOLKSWAGEN GOLF	2.0L L4 1984cc 121 CID	<b>US9069</b>		1984	HONDA WAGOVAN	1.5L L4 1487cc	
	1990-1999	VOLKSWAGEN JETTA	2.0L L4 1984cc 121 CID			1984-1987	HONDA CIVIC	1.3L L4 1342cc 82 CID	
	1995-1996	VOLKSWAGEN PASSAT	2.0L L4 1984cc 121 CID						
	1995-1997	VOLKSWAGEN DERBY	1.8L L4 1800cc 110 CID						

WATER PUMPS

USMWW	Years	Application	Engine	USMWW	Years	Application	Engine	
US9069	1984-1987	HONDA CIVIC	1.5L L4 1487cc	US9116	1988-1989	NISSAN PULSAR NX	1.8L L4 1809cc	
	1986	HONDA CIVIC	1.5L L4 1493cc		US9117	1980-1981	BMW 528I	2.8L L6 2788cc
	1986-1987	HONDA WAGOVAN	1.5L L4 1487cc	1980-1984		BMW 633CSI	3.2L L6 3210cc	
US9071	1979-1983	AUDI 5000	2.0L L5 1986cc	1980-1984		BMW 733I	3.2L L6 3210cc	
	1980	VOLVO 265	2.4L L6 2383cc	1983-1984		BMW 533I	3.2L L6 3210cc	
	1980-1981	VOLVO 264	2.4L L6 2383cc	1985-1989		BMW 635CSI	3.5L L6 3430cc	
	1982-1984	VOLVO 244	2.4L L6 2383cc	1985-1993		BMW 535I	3.5L L6 3430cc	
	1982-1984	VOLVO 245	2.4L L6 2383cc	1986-1987		BMW L7	3.5L L6 3430cc	
	1983-1984	VOLVO 760	2.4L L6 2383cc	1987		BMW L6	3.5L L6 3430cc	
	1985	VOLVO 745	2.4L L6 2383cc	1987-1988		BMW M6	3.5L L6 3453cc	
	1985	VOLVO 760	2.4L L6 2377cc	1988		BMW 535IS	3.5L L6 3430cc	
	1986	VOLVO 740	2.4L L6 2377cc	1988		BMW M5	3.5L L6 3453cc	
US9074	1985-1994	NISSAN MAXIMA	3.0L V6 2960cc 181 CID	1988-1992		BMW 735I	3.5L L6 3430cc	
	1993-1998	MERCURY VILLAGER	3.0L V6 182 CID	1988-1992	BMW 735IL	3.5L L6 3430cc		
	1993-1998	NISSAN QUEST	3.0L V6 2960cc 181 CID	US9119	1982-1987	BMW 528E	2.7L L6 2693cc	
US9075	1985-1987	TOYOTA COROLLA	1.6L L4 1587cc		1984-1987	BMW 325E	2.7L L6 2693cc	
	US9076	1985-1989	TOYOTA MR2		1.6L L4 1587cc	1986-1987	BMW 325	2.7L L6 2693cc
1987-1991		TOYOTA COROLLA	1.6L L4 1587cc		1986-1987	BMW 325ES	2.7L L6 2693cc	
US9077	1988	CHEVROLET NOVA	1.6L L4 1588cc 98 CID		1987	BMW 325I	2.5L L6 2494cc 152 CID	
	1990-1992	GEO PRIZM	1.6L L4 1587cc		1987	BMW 325IS	2.5L L6 2494cc 152 CID	
US9078	1975	VOLVO 164	3.0L L6 2980cc	US9120	1988	BMW 325	2.7L L6 2693cc	
US9078	1969-1974	TOYOTA LAND CRUISER	3.9L L6 3878cc		1988	BMW 528E	2.7L L6 2693cc	
	US9080	1985-1989	SUBARU DL		1.8L H4 1781cc	1988-1991	BMW 325IS	2.5L L6 2494cc 152 CID
1985-1989		SUBARU GL	1.8L H4 1781cc		1988-1991	BMW 325IX	2.5L L6 2494cc 152 CID	
US9080	1985-1989	SUBARU GL-10	1.8L H4 1781cc		1988-1993	BMW 325I	2.5L L6 2494cc 152 CID	
	1985-1991	SUBARU XT	1.8L H4 1781cc		1989-1990	BMW 525I	2.5L L6 2494cc 152 CID	
1986-1989	SUBARU RX	1.8L H4 1781cc	US9122		1975-1978	BMW 530I	3.0L L6 2985cc	
US9082	1972-1980	MG MGB			1.8L L4 1798cc	1977-1978	BMW 630CSI	3.0L L6 2985cc
	US9083	1985-1987			HONDA PRELUDE	2.0L L4 1955cc	1978-1979	BMW 633CSI
1986-1989		HONDA ACCORD			2.0L L4 1955cc	1978-1979	BMW 733I	3.2L L6 3210cc
US9084	1971-1973	FIAT 128		1.1L L4 1116cc	1979	BMW 528I	2.8L L6 2788cc	
	1973-1979	FIAT 128	1.3L L4 1290cc	1985-1987	BMW 735I	3.5L L6 3430cc		
	1974-1978	FIAT X-1/9	1.3L L4 1290cc	US9128	1988-1994	BMW 750IL	5.0L V12 4988cc	
	1979-1982	FIAT STRADA	1.5L L4 1498cc		US9129	1988-1991	HONDA PRELUDE	2.0L L4 1958cc
	1979-1982	FIAT X-1/9	1.5L L4 1498cc	1990-1991		HONDA PRELUDE	2.1L L4 2056cc	
US9085	1979-1982	FIAT STRADA	1.5L L4 1498cc	US9130	1988-1991	HONDA CIVIC	1.6L L4 1590cc 97 CID	
	1979-1982	FIAT X-1/9	1.5L L4 1498cc		1988-1991	HONDA CRX	1.5L L4 1493cc	
US9086	1981-1982	TOYOTA TERCEL	1.5L L4 1452cc		1988-1991	HONDA CRX	1.6L L4 1590cc 97 CID	
	US9092	1984-1985	TOYOTA VAN		2.0L L4 1998cc 122 CID	1988-1995	HONDA CIVIC	1.5L L4 1493cc
1986-1989		TOYOTA VAN	2.2L L4 2237cc		1993-1995	HONDA CIVIC DEL SOL	1.5L L4 1493cc	
1984	SUBARU BRAT	1.8L H4 1781cc	1993-1995		HONDA CIVIC DEL SOL	1.6L L4 1590cc 97 CID		
US9093	1981-1983	TOYOTA PICKUP	2.2L L4 2188cc		US9131	1988-1990	HONDA PRELUDE	2.0L L4 1958cc
	US9094	1986-1987	ACURA LEGEND			2.5L V6 2494cc	US9132	1981-1987
1987-1988		STERLING 825	2.5L V6 2494cc		1982	CHEVROLET LUV		2.2L L4 134 CID
US9097	1987-1990	ACURA LEGEND	2.7L V6 2675cc		1986-1987	ISUZU TROOPER	2.2L L4 2238cc	
	1989-1990	STERLING 827	2.7L V6 2675cc	US9133	1988-1991	ISUZU TROOPER	2.6L L4 2559cc	
	1995-1997	HONDA ACCORD	2.7L V6 2675cc		1988-1995	ISUZU PICKUP	2.6L L4 2559cc	
	US9098	1987-1994	TOYOTA TERCEL		1.5L L4 1456cc	1989-1994	ISUZU AMIGO	2.6L L4 2559cc
		1992-1994	TOYOTA PASEO		1.5L L4 1497cc	1991-1997	ISUZU RODEO	2.6L L4 2559cc
US9099	1987-1989	TOYOTA CELICA	2.0L L4 1998cc 122 CID	1994-1996	HONDA PASSPORT	2.6L L4 2559cc		
	1987-1991	TOYOTA CAMRY	2.0L L4 1998cc 122 CID	US9134	1989	ISUZU IMPULSE	2.0L L4 1994cc	
	1990-1999	TOYOTA CELICA	2.2L L4 2164cc		US9140	1986-1989	TOYOTA CELICA	2.0L L4 1998cc
	1991-1995	TOYOTA MR2	2.2L L4 2164cc	1988-1993		TOYOTA CELICA	2.0L L4 1998cc 122 CID	
	1992-2001	TOYOTA CAMRY	2.2L L4 2164cc	1991-1995	TOYOTA MR2	2.0L L4 1998cc 122 CID		
	1996-2000	TOYOTA RAV4	2.0L L4 1998cc 122 CID	US9141	1985	TOYOTA CELICA	2.4L L4 2366cc	
	1999-2001	TOYOTA SOLARA	2.2L L4 2164cc		1985-1995	TOYOTA 4RUNNER	2.4L L4 2366cc	
	US9099-2	1987-1989	TOYOTA CELICA	2.0L L4 1998cc 122 CID	1985-1995	TOYOTA PICKUP	2.4L L4 2366cc	
		1987-1991	TOYOTA CAMRY	2.0L L4 1998cc 122 CID	US9142	1988-1990	TOYOTA 4RUNNER	3.0L V6 2959cc
		1990-1999	TOYOTA CELICA	2.2L L4 2164cc		1988-1990	TOYOTA PICKUP	3.0L V6 2959cc
1991-1995		TOYOTA MR2	2.2L L4 2164cc	US9145	1989-1992	TOYOTA 4RUNNER	3.0L V6 2959cc	
1992-2001		TOYOTA CAMRY	2.2L L4 2164cc		1989-1992	TOYOTA PICKUP	3.0L V6 2959cc	
1996-2000		TOYOTA RAV4	2.0L L4 1998cc 122 CID	US9146	1979	VOLVO 262	2.7L V6 2673cc	
1999-2001		TOYOTA SOLARA	2.2L L4 2164cc		1979	VOLVO 264	2.7L V6 2673cc	
US9100		1986-1992	TOYOTA SUPRA		3.0L L6 2954cc	1979	VOLVO 265	2.7L V6 2673cc
		1989-1992	TOYOTA CRESSIDA		3.0L L6 2954cc	1980-1981	VOLVO 262	2.8L V6 2849cc
US9102		1986-1988	MAZDA RX-7		1.3L R2 1308cc	1980-1981	VOLVO 265	2.8L V6 2849cc
	US9104	1986-1989	NISSAN D21	3.0L V6 2960cc	1980-1982	VOLVO 264	2.8L V6 2849cc	
1987-1995		NISSAN PATHFINDER	3.0L V6 2960cc 181 CID	US9147	1976	VOLVO 262	2.7L V6 2673cc	
1990-1994	NISSAN D21	3.0L V6 2960cc 181 CID	1976-1978		VOLVO 264	2.7L V6 2673cc		
1995	NISSAN PICKUP	3.0L V6 2960cc 181 CID	1976-1978		VOLVO 265	2.7L V6 2673cc		
US9105	1986-1987	ISUZU PICKUP	2.3L L4 2254cc		1978	VOLVO 262	2.7L V6 2673cc	
	1986-1987	ISUZU TROOPER	2.3L L4 2254cc		US9149	1977-1979	BMW 320I	2.0L L4 1990cc 121 CID
	1988-1989	ISUZU IMPULSE	2.3L L4 2254cc	1980-1983		BMW 320I	1.8L L4 1766cc 107 CID	
	1989-1993	ISUZU AMIGO	2.3L L4 2254cc	US9150	1986-1991	VOLKSWAGEN VANAGON	2.1L H4 2109cc	
	1989-1995	ISUZU PICKUP	2.3L L4 2254cc		US9152	1984-1985	BMW 318I	1.8L L4 1766cc 107 CID
US9106	1985-1989	ISUZU IMPULSE	2.0L L4 1994cc	1986		BMW 318	1.8L L4 1800cc 110 CID	
	US9107	1986-1990	SAAB 9000	2.0L L4 1985cc	US9153	1975-1976	BMW 2002	2.0L L4 1990cc 121 CID
US9108		1981-1993	SAAB 900	2.0L L4 1985cc		US9154	1984-1985	LINCOLN CONTINENTAL
	1991-1994	SAAB 900	2.1L L4 2119cc	1984-1985	LINCOLN MARK VII		2.4L L6 146 CID	
US9109	1988-1991	SUBARU XT	2.7L H6 2672cc	1985-1986	BMW 524TD		2.4L L6 2443cc	
	US9110	1987-1988	NISSAN VAN	2.4L L4 2389cc	US9155		1988-1992	TOYOTA LAND CRUISER
US9111		1986-1987	MAZDA 626	2.0L L4 1998cc 122 CID		US9160	1989	ISUZU I-MARK
	1986-1987	MAZDA B2000	2.0L L4 1998cc 122 CID	US9161	1985-1989		SUBARU DL	1.8L H4 1781cc
US9114	1982-1986	NISSAN STANZA	2.0L L4 1974cc		1985-1989	SUBARU GL	1.8L H4 1781cc	
	US9115	1986-1989	ACURA INTEGRA		1.6L L4 1590cc	1985-1989	SUBARU GL-10	1.8L H4 1781cc
US9116		1985-1990	NISSAN PICKUP		1.8L L4 1800cc 110 CID	1986-1989	SUBARU RX	1.8L H4 1781cc
	1987	NISSAN PULSAR NX	1.6L L4 1597cc		1990-1994	SUBARU LOYALE	1.8L H4 1781cc	
	1987-1989	NISSAN ICHI VAN	1.8L L4 1800cc 110 CID	US9162	1990	NISSAN AXCESS	2.4L L4 2389cc	
	1987-1989	NISSAN STANZA	2.0L L4 1974cc		1990-1992	NISSAN STANZA	2.4L L4 2389cc	



USMW	Years	Application	Engine	USMW	Years	Application	Engine	
<b>US9163</b>	1988-1989	JAGUAR VANDEN PLAS	3.6L L6 3590cc	<b>US9206</b>	1995-1997	NISSAN PICKUP	2.4L L4 2389cc	
	1988-1989	JAGUAR XJ6	3.6L L6 3590cc		1998-2004	NISSAN FRONTIER	2.4L L4 2389cc	
	1990-1992	JAGUAR VANDEN PLAS	4.0L L6 3980cc		1998-2008	NISSAN PICKUP	2.4L L4 2389cc 146 CID	
	1990-1992	JAGUAR XJ6	4.0L L6 3980cc		2000-2004	NISSAN XTERRA	2.4L L4 2389cc	
	1993-1994	JAGUAR XJS	4.0L L6 3980cc		2000-2005	NISSAN URVAN	2.4L L4 2389cc 146 CID	
<b>US9165</b>	1975-1979	JAGUAR XJ12	5.3L V12 5343cc	2006-2007	NISSAN URVAN	2.4L L4 2392cc 146 CID		
	1976-1980	JAGUAR XJS	5.3L V12 5343cc	2008	NISSAN FRONTIER	2.4L L4 2389cc 146 CID		
	1982-1992	JAGUAR XJS	5.3L V12 5343cc	2009-2012	NISSAN NP300	2.4L L4 2389cc 146 CID		
	1993	JAGUAR XJRS	6.0L V12 5994cc	2012	NISSAN NP300	2.5L L4 2488cc 151 CID		
	1994-1995	JAGUAR XJS	6.0L V12 5994cc	<b>US9207</b>	1989-1990	NISSAN PULSAR NX	1.6L L4 1597cc 97 CID	
	1994-1996	JAGUAR XJ12	6.0L V12 5994cc		1989-1990	NISSAN SENTRA	1.6L L4 1597cc 97 CID	
<b>US9166</b>	1988-1991	MAZDA 929	3.0L V6 2954cc 180 CID	<b>US9208</b>	1989-1991	MAZDA RX-7	1.3L R2 1308cc	
	1989-1995	MAZDA MPV	3.0L V6 2954cc 180 CID	<b>US9209</b>	1990-1997	HONDA ACCORD	2.2L L4 2156cc	
<b>US9167</b>	1989-1993	MAZDA B2600	2.6L L4 2606cc	1992-1996	HONDA PRELUDE	2.2L L4 2156cc		
	1989-1994	MAZDA MPV	2.6L L4 2606cc	1995-1997	HONDA ODYSSEY	2.2L L4 2156cc		
<b>US9168</b>	1989-1992	MITSUBISHI GALANT	2.0L L4 1997cc 122 CID	1996-1997	ISUZU OASIS	2.2L L4 2156cc		
	1992	EAGLE SUMMIT	2.4L L4 2351cc	1997	ACURA CL	2.2L L4 2156cc		
	1992	MITSUBISHI EXPO	2.4L L4 2351cc	1998	HONDA ODYSSEY	2.3L L4 2234cc		
	1992	PLYMOUTH COLT	2.4L L4 2351cc	1998	ISUZU OASIS	2.3L L4 2254cc		
<b>US9170</b>	1978-1979	TOYOTA CRESSIDA	2.6L L6 2563cc	1998-1999	ACURA CL	2.3L L4 2254cc		
	1979	TOYOTA CELICA	2.6L L6 2563cc	1998-2002	HONDA ACCORD	2.3L L4 2254cc		
<b>US9171</b>	1988-1991	AUDI 90	2.3L L5 2309cc	1999	ISUZU OASIS	2.3L L4 2234cc		
	1988-1991	AUDI 90 QUATTRO	2.3L L5 2309cc	<b>US9211</b>	1975-1982	JAGUAR XJ6	4.2L L6 4235cc	
	1988-1992	AUDI 80 QUATTRO	2.3L L5 2309cc		<b>US9212</b>	1989-1992	MITSUBISHI GALANT	2.0L L4 1997cc 122 CID
	1989-1991	AUDI 100	2.3L L5 2309cc	1990-1994	EAGLE TALON	2.0L L4 1997cc 122 CID		
	1989-1991	AUDI 100 QUATTRO	2.3L L5 2309cc	1990-1994	MITSUBISHI ECLIPSE	2.0L L4 1997cc 122 CID		
	1989-1991	AUDI 200	2.2L L5 2226cc	1990-1994	PLYMOUTH LASER	2.0L L4 1997cc 122 CID		
	1989-1991	AUDI 200 QUATTRO	2.2L L5 2226cc	1992-1998	HYUNDAI SONATA	2.0L L4 1997cc		
	1990-1991	AUDI COUPE QUATTRO	2.3L L5 2309cc	1993-1995	HYUNDAI ELANTRA	1.8L L4 1836cc		
	1991-1992	AUDI 80	2.3L L5 2309cc	<b>US9213</b>	1991-1993	NISSAN NX	2.0L L4 1998cc	
<b>US9172</b>	1975-1978	MERCEDES-BENZ 230	2.3L L4 2307cc		1991-1994	NISSAN SENTRA	2.0L L4 1998cc	
	1975-1982	MERCEDES-BENZ 300D	3.0L L5 3005cc		1991-1996	INFINITI G20	2.0L L4 1998cc	
	1975-1983	MERCEDES-BENZ 240D	2.4L L4 2404cc		1993-1996	NISSAN TSURU	2.0L L4 1998cc 122 CID	
	1978-1982	MERCEDES-BENZ 300CD	3.0L L5 3005cc		1995-1998	NISSAN 200SX	2.0L L4 1998cc	
	1978-1982	MERCEDES-BENZ 300SD	3.0L L5 3005cc		1996-1997	NISSAN SENTRA	2.0L L4 1998cc 122 CID	
	1981-1982	MERCEDES-BENZ 300TD	3.0L L5 3005cc		1996-2000	NISSAN LUCINO	2.0L L4 1998cc 122 CID	
	1983-1985	MERCEDES-BENZ 300CD	3.0L L5 2998cc		1998-2001	NISSAN SENTRA	2.0L L4 1998cc	
	1983-1985	MERCEDES-BENZ 300D	3.0L L5 2998cc		1999-2002	INFINITI G20	2.0L L4 2000cc	
	1983-1985	MERCEDES-BENZ 300SD	3.0L L5 2998cc		2000	NISSAN SENTRA	1.6L L4 1597cc 97 CID	
	1983-1985	MERCEDES-BENZ 300TD	3.0L L5 2998cc	<b>US9214</b>	1988-2013	NISSAN TSURU	1.6L L4 1597cc 97 CID	
1989	MERCEDES-BENZ 300D	3.0L L6 2985cc 182 CID	1991-1993		NISSAN NX	1.6L L4 1597cc 97 CID		
<b>US9173</b>	1984	MERCEDES-BENZ 190E	2.3L L4 2299cc		1991-1999	NISSAN SENTRA	1.6L L4 1597cc 97 CID	
	<b>US9175</b>	1985-1988	MERCEDES-BENZ 190E		2.3L L4 2299cc	1993-2004	NISSAN TSBAME	1.6L L4 1597cc 97 CID
1986-1989		MERCEDES-BENZ 230E	2.3L L4 2300cc 140 CID		1995-1997	NISSAN TSURU	1.6L L4 1598cc 97 CID	
<b>US9176</b>	1991	MERCEDES-BENZ 230E	2.3L L4 2300cc 140 CID	1995-1998	NISSAN 200SX	1.6L L4 1597cc 97 CID		
	1991-1993	MERCEDES-BENZ 190E	2.3L L4 2299cc	1996-2000	NISSAN LUCINO	1.6L L4 1597cc 97 CID		
<b>US9177</b>	1975-1976	MERCEDES-BENZ 450SE	4.5L V8 4520cc	<b>US9215</b>	2002-2005	SUBARU IMPREZA	2.0L H4 1994cc	
	1975-1980	MERCEDES-BENZ 450SEL	4.5L V8 4520cc		2004-2006	SUBARU BAJA	2.5L H4 2458cc	
	1975-1980	MERCEDES-BENZ 450SL	4.5L V8 4520cc	2004-2007	SUBARU FORESTER	2.5L H4 2458cc		
	1975-1980	MERCEDES-BENZ 450SLC	4.5L V8 4520cc	2004-2014	SUBARU IMPREZA	2.5L H4 2458cc		
<b>US9178</b>	1977-1982	PORSCHE 924	2.0L L4 1983cc	2005	SAAB 9-2X	2.0L H4 1994cc		
<b>US9179</b>	1965-1967	NISSAN 411	1.3L L4 1299cc 79 CID	2005-2009	SUBARU LEGACY	2.5L H4 2458cc		
	1965-1968	NISSAN 520 PICKUP	1.3L L4 1299cc 79 CID	2005-2009	SUBARU OUTBACK	2.5L H4 2458cc		
	1965-1969	NISSAN PICKUP	1.3L L4 1300cc 79 CID	2006	SAAB 9-2X	2.5L H4 2458cc		
	1968-1969	NISSAN 521 PICKUP	1.3L L4 1299cc 79 CID	2010	SUBARU FORESTER	2.5L L4 2457cc 150 CID		
	1990-1992	NISSAN ICHI VAN	1.8L L4 1800cc 110 CID	2010	SUBARU IMPREZA	2.5L L4 2457cc 150 CID		
	1991-1994	NISSAN PICKUP	1.8L L4 1800cc 110 CID	2012-2014	SUBARU WRX	2.5L L4 2457cc 150 CID		
	<b>US9180</b>	1967-1971	TOYOTA CROWN	2.3L L6 2253cc 138 CID	2013	SUBARU LEGACY	2.5L L4 2457cc 150 CID	
		1974-1976	TOYOTA MARK II	2.6L L6 2563cc	2015	SUBARU WRX STI	2.5L H4 2458cc	
		1978-1979	TOYOTA CRESSIDA	2.6L L6 2563cc	<b>US9216</b>	1991-1997	TOYOTA PREVIA	2.4L L4 2438cc
		1979	TOYOTA CELICA	2.6L L6 2563cc		<b>US9218</b>	1991-1995	ACURA LEGEND
<b>US9181</b>	1968-1970	TOYOTA CORONA	1.9L L4 1897cc 116 CID	<b>US9219</b>	1991-2005	ACURA NSX	3.0L V6 2977cc	
	1979-1980	TOYOTA LAND CRUISER	4.2L L6 4227cc		1997-2005	ACURA NSX	3.2L V6 3179cc	
<b>US9189</b>	1980-1987	PEUGEOT 505	2.0L L4 1971cc	<b>US9220</b>	1990-1991	GEO STORM	1.6L L4 1588cc 98 CID	
<b>US9198</b>	1981-1983	NISSAN 720	2.2L L4 2164cc	1990-1992	ISUZU IMPULSE	1.6L L4 1588cc		
	1983-1986	NISSAN 720	2.5L L4 2488cc 152 CID	1991	ISUZU STYLUS	1.6L L4 1588cc		
<b>US9200</b>	1984-1985	TOYOTA PICKUP	2.4L L4 2446cc	<b>US9221</b>	1990-1993	GEO STORM	1.6L L4 1588cc 98 CID	
<b>US9201</b>	1990-1996	NISSAN 300ZX	3.0L V6 2960cc		1991-1993	ISUZU STYLUS	1.6L L4 1588cc	
<b>US9202</b>	1986	MERCEDES-BENZ 300SL	3.0L L6 2962cc 180 CID	1992	ISUZU IMPULSE	1.8L L4 1809cc 110 CID		
	1986-1987	MERCEDES-BENZ 300TE	3.0L L6 2962cc 180 CID	1992	ISUZU STYLUS	1.8L L4 1809cc 110 CID		
	1986-1993	MERCEDES-BENZ 300E	3.0L L6 2962cc	1992-1993	GEO STORM	1.8L L4 1809cc 110 CID		
	1987	MERCEDES-BENZ 260SE	2.6L L6 2599cc 158 CID	<b>US9222</b>	1990-1992	MERCEDES-BENZ 300CE	3.0L L6 2962cc	
	1987-1989	MERCEDES-BENZ 260E	2.6L L6 2599cc		1990-1993	MERCEDES-BENZ 300SL	3.0L L6 2962cc	
	1987-1993	MERCEDES-BENZ 190E	2.6L L6 2599cc	<b>US9223</b>	1990-1999	SUBARU LEGACY	2.2L H4 2212cc	
	1988-1989	MERCEDES-BENZ 300CE	3.0L L6 2962cc		1993-1997	SUBARU IMPREZA	1.8L H4 1781cc	
	1988-1991	MERCEDES-BENZ 300SE	3.0L L6 2962cc		1995-2001	SUBARU IMPREZA	2.2L H4 2212cc	
	1988-1991	MERCEDES-BENZ 300SEL	3.0L L6 2962cc		1996-2005	SUBARU LEGACY	2.5L H4 2458cc	
	1988-1993	MERCEDES-BENZ 300TE	3.0L L6 2962cc		1998-2005	SUBARU FORESTER	2.5L H4 2458cc	
	1989	MERCEDES-BENZ 260SE	2.6L L6 2599cc 158 CID		1998-2005	SUBARU IMPREZA	2.5L H4 2458cc	
	1990-1992	MERCEDES-BENZ 300E	2.6L L6 2599cc		2000-2005	SUBARU OUTBACK	2.5L H4 2458cc	
	1992	MERCEDES-BENZ 260E	2.6L L6 2599cc 158 CID		2003-2006	SUBARU BAJA	2.5L H4 2458cc	
	1993	MERCEDES-BENZ 300CE	3.0L L6 2962cc 180 CID		2005-2006	SAAB 9-2X	2.5L H4 2458cc	
	<b>US9203</b>	1966-1969	FIAT 124		1.2L L4 1197cc 73 CID	2008	SUBARU LEGACY	2.0L L4 1987cc 122 CID
		1970-1973	FIAT 124		1.4L L4 1438cc 88 CID	2008-2009	SUBARU IMPREZA	2.0L L4 1983cc 121 CID
1971-1973		FIAT 124	1.6L L4 1608cc		<b>US9224</b>	1990-1995	ACURA INTEGRA	1.8L L4 1834cc
<b>US9206</b>	1989-1998	NISSAN 240SX	2.4L L4 2389cc		<b>US9225</b>	1990-1991	MAZDA 929	3.0L V6 2954cc 180 CID
	1990-1994	NISSAN D21	2.4L L4 2389cc		<b>US9226</b>	1990-1991	AUDI V8 QUATTRO	3.6L V8 3562cc
	1991-1993	NISSAN PICKUP	2.4L L4 2389cc 146 CID	1992-1994	AUDI V8 QUATTRO	4.2L V8 4172cc		
	1991-1994	NISSAN ICHI VAN	2.4L L4 2389cc 146 CID	<b>US9227</b>	1982	SUZUKI SJ410	1.0L L3 993cc 61 CID	

WATER PUMPS

USMWW	Years	Application	Engine	USMWW	Years	Application	Engine
<b>US9227</b>	1983-1984	<b>SUZUKI SJ410</b>	1.0L L4 970cc 59 CID	<b>US9261</b>	1994	<b>BMW M3</b>	3.0L L6 2990cc 182 CID
<b>US9228</b>	1986	<b>MERCEDES-BENZ 250D</b>	2.5L L5 2497cc 152 CID	1995	<b>BMW M3</b>		3.0L L6 2990cc
	1986	<b>MERCEDES-BENZ 300D</b>	3.0L L5 2998cc 182 CID	1996	<b>BMW 528</b>		2.8L L6 2800cc 173 CID
	1986-1987	<b>MERCEDES-BENZ 300SDL</b>	3.0L L6 2998cc	1996	<b>BMW M3</b>		3.0L L6 2990cc 182 CID
	1986-1989	<b>MERCEDES-BENZ 190D</b>	2.5L L5 2497cc	1996-1999	<b>BMW 328IS</b>		2.8L L6 2793cc
	1987	<b>MERCEDES-BENZ 300D</b>	3.0L L6 2998cc	1996-1999	<b>BMW M3</b>		3.2L L6 3152cc
	1987	<b>MERCEDES-BENZ 300TD</b>	3.0L L6 2998cc	1996-2000	<b>BMW 328I</b>		2.8L L6 2793cc
	1990	<b>MERCEDES-BENZ 190DT</b>	2.5L L5 2497cc 152 CID	1997	<b>BMW 728I</b>		2.8L L6 2788cc 170 CID
	1990-1991	<b>MERCEDES-BENZ 350SDL</b>	3.4L L6 3449cc	1997-2000	<b>BMW 323I</b>		2.5L L6 2494cc 152 CID
	1990-1993	<b>MERCEDES-BENZ 300D</b>	2.5L L5 2497cc	1997-2000	<b>BMW 528I</b>		2.8L L6 2793cc
	1991	<b>MERCEDES-BENZ 350SD</b>	3.4L L6 3449cc	1997-2000	<b>BMW Z3</b>		2.8L L6 2793cc
	1992-1993	<b>MERCEDES-BENZ 300SD</b>	3.4L L6 3449cc	1998-1999	<b>BMW 323IS</b>		2.5L L6 2494cc 152 CID
	1994-1995	<b>MERCEDES-BENZ S350</b>	3.4L L6 3449cc	1998-2000	<b>BMW Z3</b>		3.2L L6 3152cc
	1995-1999	<b>MERCEDES-BENZ E300</b>	3.0L L6 2996cc	1999-2002	<b>BMW Z3</b>		2.5L L6 2494cc 152 CID
<b>US9230</b>	1981	<b>MERCEDES-BENZ 380SLC</b>	3.8L V8 3839cc	2000	<b>BMW 323CI</b>		2.5L L6 2494cc 152 CID
	1981-1983	<b>MERCEDES-BENZ 380SEL</b>	3.8L V8 3839cc	2000	<b>BMW 328CI</b>		2.8L L6 2793cc
	1981-1985	<b>MERCEDES-BENZ 380SL</b>	3.8L V8 3839cc	2000	<b>BMW Z3</b>		2.0L L6 1991cc 121 CID
	1982-1983	<b>MERCEDES-BENZ 380SEC</b>	3.8L V8 3839cc	2001	<b>BMW Z3</b>		2.2L L6 2171cc 132 CID
	1984-1985	<b>MERCEDES-BENZ 380SE</b>	3.8L V8 3839cc	2001-2002	<b>BMW Z3</b>		3.0L L6 2979cc
	1984-1985	<b>MERCEDES-BENZ 500SEC</b>	5.0L V8 4973cc	2001-2005	<b>BMW 320I</b>		2.2L L6 2171cc 132 CID
	1984-1985	<b>MERCEDES-BENZ 500SEL</b>	5.0L V8 4973cc	2001-2005	<b>BMW 325I</b>		2.5L L6 2494cc 152 CID
	1986	<b>MERCEDES-BENZ 500SE</b>	5.0L V8 4973cc 303 CID	2001-2005	<b>BMW 325XI</b>		2.5L L6 2494cc 152 CID
	1986	<b>MERCEDES-BENZ 500SL</b>	5.0L V8 4973cc 303 CID	2001-2005	<b>BMW 330I</b>		3.0L L6 2979cc
	1987	<b>MERCEDES-BENZ 500SEC</b>	5.0L V8 4973cc 303 CID	2001-2005	<b>BMW 330XI</b>		3.0L L6 2979cc
<b>US9231</b>	1986	<b>MERCEDES-BENZ 420SE</b>	4.2L V8 4196cc 256 CID	2001-2005	<b>BMW 525I</b>		2.5L L6 2494cc 152 CID
	1986	<b>MERCEDES-BENZ 420SL</b>	4.2L V8 4196cc 256 CID	2001-2005	<b>BMW 530I</b>		3.0L L6 2979cc
	1986	<b>MERCEDES-BENZ 560SE</b>	5.6L V8 5547cc 338 CID	2001-2006	<b>BMW 325CI</b>		2.5L L6 2494cc 152 CID
	1986-1989	<b>MERCEDES-BENZ 560SL</b>	5.6L V8 5547cc	2001-2006	<b>BMW 330CI</b>		3.0L L6 2979cc
	1986-1991	<b>MERCEDES-BENZ 420SEL</b>	4.2L V8 4196cc	2001-2006	<b>BMW X5</b>		3.0L L6 2979cc
	1986-1991	<b>MERCEDES-BENZ 560SEC</b>	5.6L V8 5547cc	2003-2005	<b>BMW Z4</b>		2.5L L6 2494cc 152 CID
	1986-1991	<b>MERCEDES-BENZ 560SEL</b>	5.6L V8 5547cc	2003-2005	<b>BMW Z4</b>		3.0L L6 2979cc
	1994	<b>MERCEDES-BENZ 560SEL</b>	5.6L V8 5547cc 338 CID	2004-2006	<b>BMW X3</b>		3.0L L6 2979cc
	1996	<b>MERCEDES-BENZ 560SEL</b>	5.6L V8 5547cc 338 CID	2004-2009	<b>BMW X3</b>		2.5L L6 2494cc 152 CID
<b>US9232</b>	1982	<b>SUZUKI SJ410</b>	1.0L L3 993cc 61 CID	2006-2010	<b>BMW 130I</b>		3.0L L6 2996cc 183 CID
	1983-1984	<b>SUZUKI SJ410</b>	1.0L L4 970cc 59 CID	2006-2010	<b>BMW 325I</b>		2.5L L6 2497cc 152 CID
<b>US9234</b>	1986	<b>BMW 525I</b>	2.5L L6 2494cc 152 CID	2006-2010	<b>BMW 525I</b>		2.5L L6 2497cc 152 CID
	1991-1993	<b>BMW M5</b>	3.6L L6 3553cc	2007	<b>BMW 330I</b>		3.0L L6 2996cc 183 CID
<b>US9236</b>	1990	<b>BMW 850I</b>	5.0L V12 5000cc 305 CID	2007-2009	<b>BMW Z4</b>		2.5L L6 2494cc 152 CID
	1991-1992	<b>BMW 850I</b>	5.0L V12 4988cc	2008-2010	<b>BMW 530I</b>		3.0L L6 2996cc 183 CID
	1993-1994	<b>BMW 850CI</b>	5.0L V12 4988cc	2010	<b>BMW X3</b>		2.5L L6 2497cc 152 CID
	1994-1995	<b>BMW 850CSI</b>	5.6L V12 5576cc	2011-2013	<b>BMW 325I</b>		2.5L L6 2494cc 152 CID
	1995	<b>BMW 850</b>	5.0L V12 5000cc 305 CID	<b>US9262</b>	1992-1994	<b>VOLKSWAGEN CORRADO</b>	2.8L V6 2792cc
	1996-1997	<b>BMW 850CI</b>	5.0L V12 5000cc 305 CID	1993-1997	<b>VOLKSWAGEN PASSAT</b>		2.8L V6 2792cc
<b>US9237</b>	1989-1992	<b>DAIHATSU CHARADE</b>	1.3L L4 1295cc	1994-2002	<b>VOLKSWAGEN JETTA</b>		2.8L V6 2792cc
<b>US9238</b>	1988-1992	<b>DAIHATSU CHARADE</b>	1.0L L3 993cc 61 CID	1995-2002	<b>VOLKSWAGEN GOLF</b>		2.8L V6 2792cc
<b>US9239</b>	1990-1993	<b>INFINITI Q45</b>	4.5L V8 4494cc	1997	<b>VOLKSWAGEN EUROVAN</b>		2.8L V6 2792cc
<b>US9241</b>	1987-1991	<b>PORSCHE 928</b>	5.0L V8 4950cc	1997	<b>VOLKSWAGEN PASSAT</b>		2.8L V6 2792cc
	1993-1995	<b>PORSCHE 928</b>	5.4L V8 5392cc	1999-2002	<b>VOLKSWAGEN EUROVAN</b>		2.8L V6 2792cc
<b>US9242</b>	1978-1982	<b>PORSCHE 928</b>	4.5L V8 4474cc	2001-2003	<b>VOLKSWAGEN EUROVAN</b>		2.5L L5 2461cc 150 CID
	1983-1984	<b>PORSCHE 928</b>	4.7L V8 4671cc	2002-2005	<b>SEAT ALHAMBRA</b>		2.8L V6 2792cc 170 CID
	1985-1986	<b>PORSCHE 928</b>	5.0L V8 4950cc	2007-2008	<b>SEAT ALHAMBRA</b>		2.8L V6 2792cc 170 CID
<b>US9245</b>	1983-1989	<b>PORSCHE 944</b>	2.5L L4 2475cc	2010	<b>VOLKSWAGEN BORA</b>		2.5L L5 2480cc 151 CID
	1987-1988	<b>PORSCHE 924</b>	2.5L L4 2475cc	<b>US9263</b>	1992-1994	<b>AUDI 100</b>	2.8L V6 2771cc
<b>US9250</b>	1992-1995	<b>HONDA CIVIC</b>	1.5L L4 1493cc	1992-1994	<b>AUDI 100 QUATTRO</b>		2.8L V6 2771cc
	1992-1995	<b>HONDA CIVIC</b>	1.6L L4 1590cc 97 CID	1993-1994	<b>AUDI 90 QUATTRO</b>		2.8L V6 2771cc
<b>US9251</b>	1992-1996	<b>HONDA PRELUDE</b>	2.3L L4 2259cc	1993-1995	<b>AUDI 90</b>		2.8L V6 2771cc
<b>US9252</b>	1992-1994	<b>NISSAN MAXIMA</b>	3.0L V6 2960cc 181 CID	1994-1995	<b>AUDI CABRIOLET</b>		2.8L V6 2771cc
<b>US9253</b>	1992-1994	<b>ACURA VIGOR</b>	2.5L L5 2451cc	1995	<b>AUDI A6</b>		2.8L V6 2771cc
	1995-1998	<b>ACURA TL</b>	2.5L L5 2451cc	1995	<b>AUDI A6 QUATTRO</b>		2.8L V6 2771cc
<b>US9254</b>	1992-1997	<b>SUBARU SVX</b>	3.3L H6 3318cc	<b>US9264</b>	1990-1994	<b>SAAB 9000</b>	2.3L L4 2290cc 140 CID
<b>US9255</b>	1991-1994	<b>SUBARU LEGACY</b>	2.2L H4 2212cc	1991-1998	<b>SAAB 9000</b>		2.3L L4 2290cc
	2008-2013	<b>SUBARU FORESTER</b>	2.5L H4 2458cc	<b>US9268</b>	1993-1997	<b>INFINITI J30</b>	3.0L V6 2960cc 181 CID
	2008-2014	<b>SUBARU IMPREZA</b>	2.5L H4 2458cc	<b>US9269</b>	1993-1997	<b>TOYOTA LAND CRUISER</b>	4.5L L6 4477cc
<b>US9256</b>	1992-1999	<b>LEXUS SC300</b>	3.0L L6 2997cc	1996-1997	<b>LEXUS LX450</b>		4.5L L6 4477cc
	1993-1997	<b>LEXUS GS300</b>	3.0L L6 2997cc	<b>US9270</b>	1993-2001	<b>NISSAN ALTIMA</b>	2.4L L4 2389cc
	1993-1998	<b>TOYOTA SUPRA</b>	3.0L L6 2997cc	<b>US9271</b>	1993-1997	<b>GEO PRIZM</b>	1.6L L4 1588cc 98 CID
<b>US9257</b>	1990-2000	<b>LEXUS LS400</b>	4.0L V8 3969cc	1993-1997	<b>TOYOTA COROLLA</b>		1.6L L4 1587cc
	1992-2000	<b>LEXUS SC400</b>	4.0L V8 3969cc	<b>US9272</b>	1993-1997	<b>GEO PRIZM</b>	1.8L L4 1788cc 110 CID
	1998-2000	<b>LEXUS GS400</b>	4.0L V8 3969cc	1993-1997	<b>TOYOTA COROLLA</b>		1.8L L4 1762cc 107 CID
	1998-2007	<b>LEXUS LX470</b>	4.7L V8 4663cc 285 CID	1994-1997	<b>TOYOTA CELICA</b>		1.8L L4 1762cc 107 CID
	1998-2007	<b>TOYOTA LAND CRUISER</b>	4.7L V8 4663cc 285 CID	<b>US9272-2</b>	1993-1997	<b>GEO PRIZM</b>	1.8L L4 1788cc 110 CID
	2000-2009	<b>TOYOTA TUNDRA</b>	4.7L V8 4663cc 285 CID	1993-1997	<b>TOYOTA COROLLA</b>		1.8L L4 1762cc 107 CID
	2001-2006	<b>LEXUS LS430</b>	4.3L V8 4293cc	1994-1997	<b>TOYOTA CELICA</b>		1.8L L4 1762cc 107 CID
	2001-2007	<b>LEXUS GS430</b>	4.3L V8 4293cc	<b>US9273</b>	1993-2001	<b>HONDA PRELUDE</b>	2.2L L4 2156cc
	2001-2009	<b>TOYOTA SEQUOIA</b>	4.7L V8 4663cc 285 CID	<b>US9274</b>	1992-1993	<b>VOLKSWAGEN TRANSPORTER</b>	2.5L L5 2459cc 150 CID
	2002-2010	<b>LEXUS SC430</b>	4.3L V8 4293cc	1992-1996	<b>VOLKSWAGEN EUROVAN</b>		2.5L L5 2459cc 150 CID
	2003-2009	<b>LEXUS GX470</b>	4.7L V8 4663cc 285 CID	1993-1994	<b>VOLKSWAGEN TRANSPORTER</b>		2.4L L5 2370cc 144 CID
	2003-2009	<b>TOYOTA 4RUNNER</b>	4.7L V8 4663cc 285 CID	1993-1996	<b>VOLKSWAGEN EUROVAN</b>		2.4L L5 2370cc 144 CID
<b>US9258</b>	1988-1991	<b>TOYOTA CAMRY</b>	2.5L V6 2508cc	1997	<b>VOLKSWAGEN EUROVAN</b>		2.4L L5 2390cc 146 CID
	1990-1991	<b>LEXUS ES250</b>	2.5L V6 2508cc	2004	<b>VOLKSWAGEN EUROVAN</b>		2.5L L5 2461cc 150 CID
	1992-1993	<b>LEXUS ES300</b>	3.0L V6 2959cc	<b>US9274-20</b>	2001-2004	<b>VOLKSWAGEN EUROVAN</b>	2.5L L5 2461cc 150 CID
	1992-1993	<b>TOYOTA CAMRY</b>	3.0L V6 2959cc	2008-2011	<b>VOLKSWAGEN CRAFTER</b>		2.5L L5 2459cc 150 CID
<b>US9259</b>	1993-1994	<b>FORD PROBE</b>	2.5L V6 2497cc	<b>US9275</b>	1991-1995	<b>BMW 318I</b>	1.8L L4 1796cc
<b>US9260</b>	1992-1995	<b>MAZDA 929</b>	3.0L V6 2954cc 180 CID	1991-1995	<b>BMW 318IS</b>		1.8L L4 1796cc
<b>US9261</b>	1991-1995	<b>BMW 525I</b>	2.5L L6 2494cc 152 CID	1993-1994	<b>BMW M5</b>		3.4L L6 3430cc 209 CID
	1992-1995	<b>BMW 325IS</b>	2.5L L6 2494cc 152 CID	1995	<b>BMW 318TI</b>		1.8L L4 1796cc
	1992-1997	<b>BMW 325I</b>	2.5L L6 2494cc 152 CID	1996-1997	<b>BMW 318IS</b>		1.9L L4 1895cc
				1996-1998	<b>BMW 318I</b>		1.9L L4 1895cc
				1996-1998	<b>BMW Z3</b>		1.9L L4 1895cc

USMW	Years	Application	Engine	USMW	Years	Application	Engine		
<b>US9275</b>	1996-1999	<b>BMW 318TI</b>	1.9L L4 1895cc	<b>US9306</b>	2004	<b>TOYOTA CAMRY</b>	3.3L V6 3300cc		
	1997	<b>BMW 318I</b>	1.8L L4 1800cc 110 CID		2004	<b>TOYOTA HIGHLANDER</b>	3.3L V6 3300cc		
	1999	<b>BMW Z3</b>	1.9L L4 1895cc 116 CID		2004	<b>TOYOTA SOLARA</b>	3.3L V6 3300cc		
<b>US9276</b>	1993-1994	<b>BMW 740I</b>	4.0L V8 3982cc	2004-2006	<b>LEXUS ES330</b>	3.3L V6 3300cc 202 CID			
	1993-1994	<b>BMW 740IL</b>	4.0L V8 3982cc	2004-2006	<b>LEXUS RX330</b>	3.3L V6 3300cc 202 CID			
	1994-1995	<b>BMW 530I</b>	3.0L V8 2997cc	2004-2006	<b>TOYOTA SIENNA</b>	3.3L V6 3300cc 202 CID			
	1994-1995	<b>BMW 540I</b>	4.0L V8 3982cc	2005-2006	<b>TOYOTA CAMRY</b>	3.3L V6 3300cc 202 CID			
				2005-2008	<b>TOYOTA SOLARA</b>	3.3L V6 3300cc 202 CID			
<b>US9277</b>	1991	<b>MERCEDES-BENZ 600SEL</b>	6.0L V12 5987cc 365 CID	2005-2010	<b>TOYOTA HIGHLANDER</b>	3.3L V6 3300cc 202 CID			
	1992-1993	<b>MERCEDES-BENZ 600SEL</b>	6.0L V12 5987cc	2006-2008	<b>LEXUS RX400H</b>	3.3L V6 3300cc 202 CID			
	1993	<b>MERCEDES-BENZ 600SEC</b>	6.0L V12 5987cc	<b>US9307</b>	1994-1998	<b>SAAB 900</b>	2.0L L4 1985cc		
	1993	<b>MERCEDES-BENZ 600SL</b>	6.0L V12 5987cc		1994-1998	<b>SAAB 900</b>	2.3L L4 2290cc 140 CID		
	1994-1997	<b>MERCEDES-BENZ 600SEC</b>	6.0L V12 5987cc 365 CID		1999-2002	<b>SAAB 9-3</b>	2.3L L4 2290cc 140 CID		
				1999-2003	<b>SAAB 9-3</b>	2.0L L4 1985cc			
	1994-1997	<b>MERCEDES-BENZ 600SEL</b>	6.0L V12 5987cc 365 CID	1999-2009	<b>SAAB 9-5</b>	2.3L L4 2290cc 140 CID			
	1994-1999	<b>MERCEDES-BENZ S600</b>	6.0L V12 5987cc	<b>US9309</b>	1995-2001	<b>NISSAN MAXIMA</b>	3.0L V6 2988cc 182 CID		
	1994-2002	<b>MERCEDES-BENZ SL600</b>	6.0L V12 5987cc		1996-2001	<b>INFINITI I30</b>	3.0L V6 2988cc 182 CID		
	1996-1997	<b>MERCEDES-BENZ 600CL</b>	6.0L V12 5987cc 365 CID		2001-2003	<b>INFINITI QX4</b>	3.5L V6 3498cc		
1998-1999	<b>MERCEDES-BENZ CL600</b>	6.0L V12 5987cc	2001-2004	<b>NISSAN PATHFINDER</b>	3.5L V6 3498cc				
2003	<b>MERCEDES-BENZ CL600</b>	5.8L V12 5786cc 353 CID	<b>US9310</b>	1994-1996	<b>MINI COOPER</b>	3.5L V6 3497cc 215 CID			
				1996-1997	<b>MERCEDES-BENZ C36 AMG</b>	3.6L L6 3606cc			
<b>US9278</b>	1992-1997	<b>ISUZU TROOPER</b>	3.2L V6 3165cc	<b>US9313</b>	1993	<b>MERCEDES-BENZ 300CE</b>	3.2L L6 3199cc		
	1993-1997	<b>ISUZU RODEO</b>	3.2L V6 3165cc		1993	<b>MERCEDES-BENZ 300E</b>	2.8L L6 2799cc		
	1994-1997	<b>HONDA PASSPORT</b>	3.2L V6 3165cc		1993	<b>MERCEDES-BENZ 300E</b>	3.2L L6 3199cc		
	1996-1997	<b>ACURA SLX</b>	3.2L V6 3165cc		1993	<b>MERCEDES-BENZ 300TE</b>	3.2L L6 3199cc		
<b>US9279</b>	1992-1994	<b>AUDI S4</b>	2.2L L5 2226cc	1994-1995	<b>MERCEDES-BENZ C280</b>	2.8L L6 2799cc			
	1995	<b>AUDI S6</b>	2.2L L5 2226cc	1994-1995	<b>MERCEDES-BENZ E320</b>	3.2L L6 3199cc			
<b>US9280</b>	1993-1994	<b>JAGUAR VANDEN PLAS</b>	4.0L L6 3980cc	1994-1996	<b>MERCEDES-BENZ SL320</b>	3.2L L6 3199cc			
	1993-1994	<b>JAGUAR XJ6</b>	4.0L L6 3980cc	<b>US9314</b>	1994	<b>MERCEDES-BENZ 220E</b>	2.2L L4 2199cc 134 CID		
	1993-1994	<b>JAGUAR XJS</b>	4.0L L6 3980cc		1994-1996	<b>MERCEDES-BENZ C220</b>	2.2L L4 2199cc		
<b>US9282</b>	1967-1972	<b>RENAULT R10</b>	1.3L L4 1300cc 79 CID	1997	<b>MERCEDES-BENZ SLK230</b>	2.3L L4 2295cc 140 CID			
	1968-1975	<b>RENAULT R8S</b>	1.3L L4 1300cc 79 CID	1997-1998	<b>MERCEDES-BENZ C230</b>	2.3L L4 2295cc			
	1971-1983	<b>RENAULT R12</b>	1.3L L4 1300cc 79 CID	<b>US9315</b>	1989	<b>MERCEDES-BENZ 500SL</b>	5.0L V8 4973cc 303 CID		
	1977-1984	<b>RENAULT R5</b>	1.3L L4 1300cc 79 CID		1990-1993	<b>MERCEDES-BENZ 500SL</b>	5.0L V8 4973cc		
	1979-1983	<b>RENAULT R5</b>	1.3L L4 1289cc 79 CID		1991	<b>MERCEDES-BENZ 500E</b>	5.0L V8 4973cc 303 CID		
	1980-1982	<b>RENAULT R12</b>	1.3L L4 1289cc 79 CID	1991	<b>MERCEDES-BENZ 500SEL</b>	5.0L V8 4973cc 303 CID			
	1985	<b>NISSAN TSURU</b>	1.5L L4 1488cc	1992	<b>MERCEDES-BENZ 400SE</b>	4.2L V8 4196cc			
1986-1987	<b>NISSAN TSURU</b>	1.6L L4 1597cc 97 CID	1992-1993	<b>MERCEDES-BENZ 400E</b>	4.2L V8 4196cc				
1988-1992	<b>NISSAN HIKARI</b>	1.6L L4 1597cc 97 CID	1992-1993	<b>MERCEDES-BENZ 500E</b>	5.0L V8 4973cc				
<b>US9288</b>	1993-1995	<b>ACURA LEGEND</b>	3.2L V6 3206cc	1992-1993	<b>MERCEDES-BENZ 500SEL</b>	5.0L V8 4973cc			
	1994-1995	<b>ACURA INTEGRA</b>	1.8L L4 1797cc	1993	<b>MERCEDES-BENZ 400SEL</b>	4.2L V8 4196cc			
<b>US9289</b>	1994-1995	<b>ACURA INTEGRA</b>	1.8L L4 1797cc	1993	<b>MERCEDES-BENZ 500SEC</b>	5.0L V8 4973cc			
<b>US9291</b>	1993-1994	<b>TOYOTA T100</b>	3.0L V6 2959cc	1994	<b>MERCEDES-BENZ 500SEL</b>	5.0L V8 4973cc 303 CID			
	1993-1995	<b>TOYOTA 4RUNNER</b>	3.0L V6 2959cc	1994	<b>MERCEDES-BENZ E500</b>	5.0L V8 4973cc			
	1993-1995	<b>TOYOTA PICKUP</b>	3.0L V6 2959cc	1994-1995	<b>MERCEDES-BENZ E420</b>	4.2L V8 4196cc			
<b>US9292</b>	1992-2000	<b>LEXUS SC300</b>	3.0L L6 2997cc	1994-1995	<b>MERCEDES-BENZ S420</b>	4.2L V8 4196cc			
	1993-1998	<b>TOYOTA SUPRA</b>	3.0L L6 2997cc	1994-1995	<b>MERCEDES-BENZ S500</b>	5.0L V8 4973cc			
<b>US9293</b>	1994-1998	<b>TOYOTA T100</b>	2.7L L4 2694cc	1994-1996	<b>MERCEDES-BENZ SL500</b>	5.0L V8 4973cc			
	1995-2004	<b>TOYOTA TACOMA</b>	2.4L L4 2438cc	<b>US9318</b>	1992-1994	<b>MAZDA MX-3</b>	1.8L V6 1845cc		
	1995-2017	<b>TOYOTA TACOMA</b>	2.7L L4 2694cc		1993-1997	<b>MAZDA MX-6</b>	2.5L V6 2497cc		
	1996-2000	<b>TOYOTA 4RUNNER</b>	2.7L L4 2694cc	1993-2002	<b>MAZDA 626</b>	2.5L V6 2497cc			
	2004-2010	<b>TOYOTA HILUX</b>	2.7L L4 2694cc 164 CID	1995-1997	<b>FORD PROBE</b>	2.5L V6 2497cc			
	2006-2009	<b>TOYOTA HIACE</b>	2.7L L4 2694cc 164 CID	1995-2001	<b>MAZDA MILLENIA</b>	2.5L V6 2497cc			
	2010	<b>TOYOTA 4RUNNER</b>	2.7L L4 2694cc	2002	<b>MAZDA MILLENIA</b>	2.5L V6 2450cc 155 CID			
	2011-2012	<b>TOYOTA HIACE</b>	2.7L L4 2694cc 164 CID	<b>US9320</b>	1993-1994	<b>TOYOTA T100</b>	3.0L V6 2959cc		
	<b>US9299</b>	1966-1969	<b>MERCEDES-BENZ 230</b>		2.3L L6 2306cc 141 CID	1993-1995	<b>TOYOTA 4RUNNER</b>	3.0L V6 2959cc	
		1968-1969	<b>MERCEDES-BENZ 300SEL</b>		2.8L L6 2778cc	1993-1995	<b>TOYOTA PICKUP</b>	3.0L V6 2959cc	
1968-1972		<b>MERCEDES-BENZ 250</b>	2.5L L6 2496cc 152 CID	<b>US9321</b>	1992-1993	<b>ACURA INTEGRA</b>	1.7L L4 1678cc		
1969-1971		<b>MERCEDES-BENZ 280S</b>	2.8L L6 2778cc		1994-1995	<b>HONDA CIVIC DEL SOL</b>	1.6L L4 1590cc 97 CID		
1969-1971		<b>MERCEDES-BENZ 280SEL</b>	2.8L L6 2778cc	<b>US9324</b>	1995-1998	<b>TOYOTA T100</b>	3.4L V6 3378cc		
1969-1971		<b>MERCEDES-BENZ 280SL</b>	2.8L L6 2778cc		1995-2004	<b>TOYOTA TACOMA</b>	3.4L V6 3378cc		
1969-1972		<b>MERCEDES-BENZ 280SE</b>	2.8L L6 2778cc		1996-2002	<b>TOYOTA 4RUNNER</b>	3.4L V6 3378cc		
1970-1972		<b>MERCEDES-BENZ 250C</b>	2.8L L6 2778cc	2000-2004	<b>TOYOTA TUNDRA</b>	3.4L V6 3378cc			
1973-1976		<b>MERCEDES-BENZ 280</b>	2.8L L6 2746cc	<b>US9325</b>	1995-1998	<b>TOYOTA T100</b>	3.4L V6 3378cc		
1973-1976		<b>MERCEDES-BENZ 280C</b>	2.8L L6 2746cc		1995-2000	<b>TOYOTA TACOMA</b>	3.4L V6 3378cc		
1975-1976		<b>MERCEDES-BENZ 280S</b>	2.8L L6 2746cc		2000-2004	<b>TOYOTA TUNDRA</b>	3.4L V6 3378cc		
1977-1980		<b>MERCEDES-BENZ 280SE</b>	2.8L L6 2746cc	<b>US9327</b>	1977-1979	<b>TOYOTA LAND CRUISER</b>	4.2L L6 4227cc		
1978-1980		<b>MERCEDES-BENZ 280CE</b>	2.8L L6 2746cc		<b>US9328</b>	1995-2002	<b>MAZDA MILLENIA</b>	2.3L V6 2254cc	
1978-1980		<b>MERCEDES-BENZ 280E</b>	2.8L L6 2746cc	<b>US9332</b>		1994-1995	<b>BMW 840CI</b>	4.0L V8 3982cc	
<b>US9300</b>		1977	<b>MAZDA 808</b>		1.6L L4 1587cc	1995	<b>BMW 740I</b>	4.0L V8 3982cc	
		<b>US9301</b>	1979-1983		<b>RENAULT R5</b>	1.3L L4 1289cc 79 CID	1995	<b>BMW 740IL</b>	4.0L V8 3982cc
			1993-1996	<b>INFINITI Q45</b>	4.5L V8 4494cc	1996	<b>BMW 540I</b>	4.0L V8 3982cc 243 CID	
<b>US9304</b>	1994-1995	<b>MAZDA MX-3</b>	1.6L L4 1597cc	<b>US9333</b>	1995	<b>AUDI 90</b>	2.8L V6 2771cc		
	1994-1997	<b>MAZDA MIATA</b>	1.8L L4 1839cc		1995	<b>AUDI 90 QUATTRO</b>	2.8L V6 2771cc		
	1995	<b>MAZDA PROTEGE</b>	1.5L L4 1489cc		1995-1998	<b>AUDI CABRIOLET</b>	2.8L V6 2771cc		
	1995-1997	<b>KIA SEPHIA</b>	1.6L L4 1597cc		1995-2001	<b>AUDI A6</b>	2.8L V6 2771cc		
	1995-1997	<b>KIA SEPHIA</b>	1.8L L4 1839cc		1995-2001	<b>AUDI A6 QUATTRO</b>	2.8L V6 2771cc		
	1995-1998	<b>MAZDA PROTEGE</b>	1.8L L4 1839cc		1996-2001	<b>AUDI A4</b>	2.8L V6 2771cc		
	1999-2001	<b>MAZDA PROTEGE</b>	1.6L L4 1589cc		1996-2001	<b>AUDI A4 QUATTRO</b>	2.8L V6 2771cc		
	1999-2005	<b>MAZDA MIATA</b>	1.8L L4 1839cc		1998-2005	<b>VOLKSWAGEN PASSAT</b>	2.8L V6 2771cc		
	<b>US9306</b>	1994-1995	<b>LEXUS ES300</b>		3.0L V6 2995cc	2000	<b>VOLKSWAGEN PASSAT</b>	2.8L V6 2771cc 170 CID	
		1994-2006	<b>TOYOTA CAMRY</b>		3.0L V6 2995cc	<b>US9334</b>	1994	<b>TOYOTA TERCEL</b>	1.5L L4 1456cc
		1995-2004	<b>TOYOTA AVALON</b>		3.0L V6 2995cc		1995-1998	<b>TOYOTA PASEO</b>	1.5L L4 1497cc
1996-1998		<b>LEXUS ES300</b>	3.0L V6 2995cc	1995-1998	<b>TOYOTA TERCEL</b>		1.5L L4 1497cc		
1998-2003		<b>TOYOTA SIENNA</b>	3.0L V6 2995cc	<b>US9337</b>	1981-1987	<b>TOYOTA LAND CRUISER</b>	4.2L L6 4227cc		
1999-2003		<b>LEXUS ES300</b>	3.0L V6 2995cc		<b>US9338</b>	1996-2000	<b>NISSAN PATHFINDER</b>	3.3L V6 3275cc	
1999-2003		<b>LEXUS RX300</b>	3.0L V6 2995cc	1997-2000		<b>INFINITI QX4</b>	3.3L V6 3275cc		
1999-2003		<b>TOYOTA SOLARA</b>	3.0L V6 2995cc	1999-2004		<b>NISSAN FRONTIER</b>	3.3L V6 3275cc		
2001-2003		<b>TOYOTA HIGHLANDER</b>	3.0L V6 2995cc	2000-2004	<b>NISSAN XTERRA</b>	3.3L V6 3275cc			

WATER PUMPS



USMW	Years	Application	Engine	USMW	Years	Application	Engine	
<b>US9339</b>	1992-1994	<b>VOLVO</b> 960	2.9L L6 2922cc	<b>US9352</b>	1996-2000	<b>HONDA</b> CIVIC	1.6L L4 1590cc	
	1993-1997	<b>VOLVO</b> 850	2.4L L5 2435cc		1996-2000	<b>HONDA</b> CIVIC	1.6L L4 1590cc 97 CID	
	1994-1997	<b>VOLVO</b> 850	2.3L L5 2319cc	<b>US9353</b>	1996-1997	<b>HYUNDAI</b> ELANTRA	1.8L L4 1795cc	
	1998-2000	<b>VOLVO</b> S70	2.3L L5 2319cc		1997	<b>HYUNDAI</b> TIBURON	1.8L L4 1795cc	
	1998-2000	<b>VOLVO</b> S70	2.4L L5 2435cc		1997	<b>HYUNDAI</b> TIBURON	2.0L L4 1975cc	
	1998-2004	<b>VOLVO</b> C70	2.3L L5 2319cc		1998	<b>HYUNDAI</b> ELANTRA	1.8L L4 1796cc	
	1998-2004	<b>VOLVO</b> C70	2.4L L5 2435cc		1998-1999	<b>HYUNDAI</b> TIBURON	2.0L L4 1997cc	
	1998-2004	<b>VOLVO</b> V70	2.3L L5 2319cc		1999-2000	<b>HYUNDAI</b> ELANTRA	2.0L L4 1975cc	
	1998-2007	<b>VOLVO</b> V70	2.4L L5 2435cc	<b>US9354</b>	1996-2004	<b>ACURA</b> RL	3.5L V6 3475cc	
	1999	<b>VOLVO</b> S40	1.9L L4 1948cc 119 CID		<b>US9356</b>	1993-1996	<b>JAGUAR</b> XJS	4.0L L6 3980cc
	1999	<b>VOLVO</b> V40	1.9L L4 1948cc 119 CID	1995-1997		<b>JAGUAR</b> VANDEN PLAS	4.0L L6 3980cc	
	2000-2004	<b>VOLVO</b> S40	1.9L L4 1948cc	1995-1997		<b>JAGUAR</b> XJ6	4.0L L6 3980cc	
	2000-2004	<b>VOLVO</b> V40	1.9L L4 1948cc	1995-1997		<b>JAGUAR</b> XJR	4.0L L6 3980cc	
	2001-2004	<b>VOLVO</b> S60	2.3L L5 2319cc	<b>US9359</b>	1997-2002	<b>MITSUBISHI</b> MIRAGE	1.5L L4 1468cc 90 CID	
	2001-2009	<b>VOLVO</b> S60	2.4L L5 2435cc		<b>US9360</b>	1997-2002	<b>MITSUBISHI</b> MIRAGE	1.8L L4 1834cc 112 CID
	2003-2006	<b>VOLVO</b> XC90	2.5L L5 2521cc			2002-2004	<b>MITSUBISHI</b> LANCER	2.0L L4 2000cc
	2003-2006	<b>VOLVO</b> XC90	2.8L L6 2783cc 170 CID			2003-2004	<b>MITSUBISHI</b> SPACE STAR	1.8L L4 1755cc 107 CID
	2003-2007	<b>VOLVO</b> V70	2.5L L5 2521cc	2005-2007		<b>MITSUBISHI</b> LANCER	2.0L L4 1995cc 122 CID	
	2003-2007	<b>VOLVO</b> XC70	2.5L L5 2521cc	<b>US9362</b>	1997-1999	<b>AUDI</b> A8	3.7L V8 3697cc	
	2003-2009	<b>VOLVO</b> S60	2.5L L5 2521cc		1997-1999	<b>AUDI</b> A8 QUATTRO	4.2L V8 4172cc	
	2004-2006	<b>VOLVO</b> S80	2.5L L5 2521cc	<b>US9364</b>	1996-1997	<b>HYUNDAI</b> ACCENT	1.5L L4 1495cc	
	2004-2006	<b>VOLVO</b> S80	2.8L L6 2783cc 170 CID		2001-2002	<b>HYUNDAI</b> ACCENT	1.5L L4 1495cc	
	2004-2010	<b>VOLVO</b> S40	2.4L L5 2435cc		2001-2005	<b>HYUNDAI</b> ACCENT	1.6L L4 1600cc	
	2004-2011	<b>VOLVO</b> S40	2.5L L5 2521cc		2004-2006	<b>DODGE</b> VERNA	1.6L L4 1598cc 97 CID	
	2005-2010	<b>VOLVO</b> V50	2.4L L5 2435cc		2006-2010	<b>DODGE</b> ATTITUDE	1.6L L4 1598cc 97 CID	
	2005-2011	<b>VOLVO</b> V50	2.5L L5 2521cc		2006-2011	<b>HYUNDAI</b> ACCENT	1.6L L4 1599cc	
	2006-2013	<b>VOLVO</b> C70	2.5L L5 2521cc		2006-2011	<b>KIA</b> RIO	1.6L L4 1599cc	
	2007	<b>VOLVO</b> XC90	2.5L L5 2521cc 154 CID		2006-2011	<b>KIA</b> RIO5	1.6L L4 1599cc	
	2007-2011	<b>FORD</b> FOCUS	2.5L L5 2521cc 154 CID		2011	<b>DODGE</b> ATTITUDE	1.6L L4 1599cc 98 CID	
	2008-2009	<b>VOLVO</b> C30	2.4L L5 2400cc 146 CID		<b>US9365</b>	1998-1999	<b>ACURA</b> SLX	3.5L V6 3494cc
	2008-2013	<b>VOLVO</b> C30	2.5L L5 2521cc	1998-2000		<b>ISUZU</b> AMIGO	3.2L V6 3165cc	
	2012-2016	<b>VOLVO</b> S60	2.5L L5 2521cc	1998-2002		<b>HONDA</b> PASSPORT	3.2L V6 3165cc	
	2015-2016	<b>VOLVO</b> V60	2.5L L5 2521cc	1998-2002		<b>ISUZU</b> TROOPER	3.5L V6 3475cc	
	2015-2016	<b>VOLVO</b> V60 CROSS COUNTRY	2.5L L5 2521cc	1998-2004		<b>ISUZU</b> RODEO	3.2L V6 3165cc	
	2015-2016	<b>VOLVO</b> XC60	2.5L L5 2521cc	1999-2001		<b>ISUZU</b> VEHICROSS	3.5L V6 3475cc	
	2016	<b>VOLVO</b> S60 CROSS COUNTRY	2.5L L5 2521cc	2001-2003		<b>ISUZU</b> RODEO SPORT	3.2L V6 3165cc	
	2016	<b>VOLVO</b> XC70	2.5L L5 2521cc	2002		<b>ISUZU</b> AXIOM	3.5L V6 3475cc	
	<b>US9340</b>	1995-1997	<b>VOLVO</b> 960	2.9L L6 2922cc		2003	<b>ISUZU</b> AXIOM	3.5L V6 3491cc
		1997-1998	<b>VOLVO</b> S90	2.9L L6 2917cc		2004	<b>ISUZU</b> AXIOM	3.5L V6 3494cc
		1997-1998	<b>VOLVO</b> V90	2.9L L6 2917cc	2004	<b>ISUZU</b> RODEO	3.5L V6 3494cc	
<b>US9342</b>	1996-1998	<b>SUZUKI</b> SIDEKICK	1.8L L4 1840cc	<b>US9368</b>	1987-1988	<b>LAND ROVER</b> RANGE ROVER	3.5L V8 3532cc 216 CID	
	1999-2002	<b>SUZUKI</b> ESTEEM	1.8L L4 1790cc		1989-1992	<b>LAND ROVER</b> RANGE ROVER	3.9L V8 3947cc	
	1999-2003	<b>CHEVROLET</b> TRACKER	2.0L L4 122 CID		1993	<b>LAND ROVER</b> DEFENDER 110	3.9L V8 3950cc	
	1999-2003	<b>SUZUKI</b> VITARA	2.0L L4 2000cc		1993-1995	<b>LAND ROVER</b> RANGE ROVER	3.9L V8 3950cc	
	2002-2003	<b>SUZUKI</b> AERIO	2.0L L4 2000cc		1993-1995	<b>LAND ROVER</b> RANGE ROVER	4.2L V8 4200cc	
	2004-2007	<b>SUZUKI</b> AERIO	2.3L L4 2290cc 140 CID		1994-1995	<b>LAND ROVER</b> DEFENDER 90	3.9L V8 3950cc	
	2005-2008	<b>CHEVROLET</b> TRACKER	2.0L L4 1983cc 121 CID		<b>US9369</b>	1993-1995	<b>LAND ROVER</b> RANGE ROVER	3.9L V8 3950cc
2007-2009	<b>SUZUKI</b> SX4	2.0L L4 1995cc	1993-1995			<b>LAND ROVER</b> RANGE ROVER	4.2L V8 4200cc	
<b>US9343</b>	1992-1993	<b>MERCEDES-BENZ</b> 300SE	3.2L L6 3199cc			1994-1995	<b>LAND ROVER</b> DISCOVERY	3.9L V8 3950cc
	1994-1996	<b>MERCEDES-BENZ</b> S320	3.2L L6 3199cc			1995-2000	<b>LAND ROVER</b> RANGE ROVER	4.0L V8 3950cc
<b>US9344</b>	1996-1997	<b>MERCEDES-BENZ</b> C280	2.8L L6 2799cc	1996-2002		<b>LAND ROVER</b> DISCOVERY	4.0L V8 3950cc	
	1996-1997	<b>MERCEDES-BENZ</b> E320	3.2L L6 3199cc	1996-2002		<b>LAND ROVER</b> RANGE ROVER	4.6L V8 4554cc 278 CID	
	1997	<b>MERCEDES-BENZ</b> SL320	3.2L L6 3199cc	1997		<b>LAND ROVER</b> DEFENDER 90	4.0L V8 3950cc	
<b>US9345</b>	1999	<b>MERCEDES-BENZ</b> E280	2.8L L6 2800cc 171 CID	2003-2004		<b>LAND ROVER</b> DISCOVERY	4.6L V8 4554cc 278 CID	
	1993	<b>MERCEDES-BENZ</b> 280E	2.8L L6 2799cc 171 CID	<b>US9371</b>		1996-1998	<b>MAZDA</b> PROTEGE	1.5L L4 1489cc
	1993	<b>MERCEDES-BENZ</b> 300CE	3.2L L6 3199cc			<b>US9374</b>	1997-2000	<b>SUZUKI</b> ESTEEM
	1993	<b>MERCEDES-BENZ</b> 300E	3.2L L6 3199cc	1999-2000	<b>CHEVROLET</b> TRACKER		1.6L L4 1588cc 98 CID	
	1993	<b>MERCEDES-BENZ</b> 300TE	3.2L L6 3199cc	1999-2001	<b>SUZUKI</b> VITARA		1.6L L4 1590cc 97 CID	
	1994-1995	<b>MERCEDES-BENZ</b> E320	3.2L L6 3199cc	2007-2009	<b>SUZUKI</b> SWIFT		1.5L L4 1500cc 92 CID	
	1994-1996	<b>MERCEDES-BENZ</b> SL320	3.2L L6 3199cc	<b>US9375</b>	1998-2000	<b>ISUZU</b> AMIGO	2.2L L4 2180cc	
1995	<b>MERCEDES-BENZ</b> C36 AMG	3.6L L6 3606cc	1998-2003		<b>ISUZU</b> RODEO	2.2L L4 2180cc		
1995	<b>MERCEDES-BENZ</b> C280	2.8L L6 2799cc	1999-2002		<b>DAEWOO</b> LEGANZA	2.2L L4 2200cc		
<b>US9346</b>	1992	<b>MERCEDES-BENZ</b> 400SE	4.2L V8 4196cc		1999-2002	<b>DAEWOO</b> NUBIRA	2.0L L4 1998cc	
	1992-1993	<b>MERCEDES-BENZ</b> 400E	4.2L V8 4196cc	2001-2003	<b>ISUZU</b> RODEO SPORT	2.2L L4 2180cc		
	1992-1993	<b>MERCEDES-BENZ</b> 500E	5.0L V8 4973cc	<b>US9376</b>	1998-2002	<b>CHEVROLET</b> PRIZM	1.8L L4 110 CID	
	1992-1993	<b>MERCEDES-BENZ</b> 500SEL	5.0L V8 4973cc		1998-2008	<b>TOYOTA</b> COROLLA	1.8L L4 1794cc	
	1993	<b>MERCEDES-BENZ</b> 400SEL	4.2L V8 4196cc		2000-2005	<b>TOYOTA</b> CELICA	1.8L L4 1794cc	
	1993	<b>MERCEDES-BENZ</b> 500SEC	5.0L V8 4973cc		2000-2006	<b>TOYOTA</b> MR2 SPYDER	1.8L L4 1794cc	
	1993	<b>MERCEDES-BENZ</b> 500SL	5.0L V8 4973cc	2003-2008	<b>TOYOTA</b> MATRIX	1.8L L4 1794cc		
	1994	<b>MERCEDES-BENZ</b> 400E	4.2L V8 4196cc 256 CID	<b>US9377</b>	1998-2011	<b>VOLKSWAGEN</b> BEETLE	2.0L L4 1984cc 121 CID	
	1994	<b>MERCEDES-BENZ</b> E500	5.0L V8 4973cc		1999-2001	<b>AUDI</b> A3	1.8L L4 1754cc 107 CID	
	1994-1995	<b>MERCEDES-BENZ</b> E420	4.2L V8 4196cc		1999-2005	<b>VOLKSWAGEN</b> BEETLE	1.8L L4 1781cc	
	1994-1999	<b>MERCEDES-BENZ</b> S420	4.2L V8 4196cc		1999-2007	<b>VOLKSWAGEN</b> GOLF	2.0L L4 1984cc 121 CID	
	1994-1999	<b>MERCEDES-BENZ</b> S500	5.0L V8 4973cc		1999-2015	<b>VOLKSWAGEN</b> JETTA	2.0L L4 1984cc 121 CID	
	1994-1999	<b>MERCEDES-BENZ</b> SL500	5.0L V8 4973cc		2000-2001	<b>AUDI</b> S3 QUATTRO	1.8L L4 1754cc 107 CID	
	1995	<b>MERCEDES-BENZ</b> 400SEL	4.2L V8 4196cc 256 CID		2000-2003	<b>VOLKSWAGEN</b> POINTER	2.0L L4 1984cc 121 CID	
	1995-1997	<b>MERCEDES-BENZ</b> 500SEL	5.0L V8 4973cc 303 CID		2000-2005	<b>VOLKSWAGEN</b> JETTA	1.8L L4 1781cc	
	1996-1997	<b>MERCEDES-BENZ</b> 400SE	4.2L V8 4196cc 256 CID		2000-2005	<b>VOLKSWAGEN</b> PASSAT	1.8L L4 1781cc	
	1996-1997	<b>MERCEDES-BENZ</b> 420SL	4.2L V8 4196cc 256 CID		2000-2006	<b>AUDI</b> TT	1.8L L4 1781cc	
	1996-1997	<b>MERCEDES-BENZ</b> 500CL	5.0L V8 4973cc 303 CID	2000-2006	<b>AUDI</b> TT QUATTRO	1.8L L4 1781cc		
	1996-1997	<b>MERCEDES-BENZ</b> 500SEC	5.0L V8 4973cc 303 CID	2000-2006	<b>VOLKSWAGEN</b> GOLF	1.8L L4 1781cc		
	1997	<b>MERCEDES-BENZ</b> 400SEL	4.2L V8 4196cc 256 CID	2001-2003	<b>SEAT</b> LEON	1.8L L4 1781cc 108 CID		
1997	<b>MERCEDES-BENZ</b> E420	4.2L V8 4196cc	2001-2003	<b>SEAT</b> TOLEDO	1.8L L4 1781cc 108 CID			
1998-1999	<b>MERCEDES-BENZ</b> CL500	5.0L V8 4973cc	2001-2005	<b>AUDI</b> A4 QUATTRO	1.8L L4 1781cc			
<b>US9348</b>	1996-1998	<b>ACURA</b> TL	3.2L V6 3206cc	2001-2006	<b>AUDI</b> A4	1.8L L4 1781cc		
	<b>US9349</b>	1996-2001	<b>ACURA</b> INTEGRA	1.8L L4 1834cc	2002-2003	<b>SEAT</b> ALHAMBRA	1.8L L4 1781cc 108 CID	
		1997-2001	<b>HONDA</b> CR-V	2.0L L4 1972cc	2002-2003	<b>VOLKSWAGEN</b> DERBY	2.0L L4 1984cc 121 CID	
<b>US9351</b>	1997-1999	<b>MERCEDES-BENZ</b> S320	3.2L L6 3199cc	2002-2004	<b>AUDI</b> A3	1.8L L4 1781cc 108 CID		
<b>US9352</b>	1996-1997	<b>HONDA</b> CIVIC DEL SOL	1.6L L4 1590cc 97 CID	2002-2004	<b>AUDI</b> S3 QUATTRO	1.8L L4 1781cc 108 CID		

USMW	Years	Application	Engine	USMW	Years	Application	Engine											
<b>US9377</b>	2002-2008	<b>VOLKSWAGEN SHARAN</b>	1.8L L4 1781cc 109 CID	<b>US9380</b>	2006	<b>MERCEDES-BENZ ML500</b>	5.0L V8 4966cc											
	2003	<b>SEAT ALHAMBRA</b>	1.8L L4 1798cc 110 CID		2006-2008	<b>MERCEDES-BENZ G500</b>	5.0L V8 4966cc											
	2003-2005	<b>SEAT TOLEDO</b>	1.8L L4 1781cc 109 CID		2007	<b>MERCEDES-BENZ C55 AMG</b>	5.5L V8 5439cc 332 CID											
	2003-2007	<b>VOLKSWAGEN POLO</b>	2.0L L4 1984cc 121 CID		2007	<b>MERCEDES-BENZ ML500</b>	5.0L V8 4966cc 303 CID											
	2003-2009	<b>SEAT CORDOBA</b>	2.0L L4 1984cc 121 CID		2007-2011	<b>MERCEDES-BENZ S500L</b>	5.5L V8 5461cc 333 CID											
	2003-2009	<b>VOLKSWAGEN POINTER</b>	1.8L L4 1781cc 109 CID		2008-2009	<b>MERCEDES-BENZ S600L</b>	5.5L V12 5513cc 336 CID											
	2003-2012	<b>SEAT IBIZA</b>	2.0L L4 1984cc 121 CID		2008-2010	<b>MERCEDES-BENZ CL500</b>	5.5L V8 5461cc 333 CID											
	2004	<b>SEAT TOLEDO</b>	1.8L L4 1798cc 110 CID		2008-2011	<b>MERCEDES-BENZ CLS500</b>	5.5L V8 5461cc 333 CID											
	2004-2005	<b>AUDI A3</b>	2.0L L4 1984cc 121 CID		2008-2011	<b>MERCEDES-BENZ E500</b>	5.5L V8 5461cc 333 CID											
	2004-2006	<b>SEAT LEON</b>	1.8L L4 1781cc 109 CID		2008-2011	<b>MERCEDES-BENZ GL500</b>	5.5L V8 5461cc 333 CID											
	2004-2007	<b>SEAT ALHAMBRA</b>	1.8L L4 1781cc 109 CID		2008-2011	<b>MERCEDES-BENZ SL500</b>	5.5L V8 5461cc 333 CID											
	2005	<b>AUDI A3</b>	2.0L L4 1998cc 122 CID		<b>US9382</b>	1999-2001	<b>VOLVO S80</b>	2.8L L6 2798cc										
	2005	<b>SEAT IBIZA</b>	1.8L L4 1798cc 110 CID			1999-2002	<b>VOLVO S80</b>	2.9L L6 2917cc										
	2005-2006	<b>SEAT ALTEA</b>	2.0L L4 1984cc 121 CID			1997-1999	<b>ACURA CL</b>	3.0L V6 2997cc										
	2006	<b>SEAT TOLEDO</b>	2.0L L4 1984cc 121 CID			1998-2002	<b>HONDA ACCORD</b>	3.0L V6 2997cc										
	2006	<b>VOLKSWAGEN BORA</b>	2.0L L4 1984cc 121 CID			1999-2003	<b>ACURA TL</b>	3.2L V6 3210cc										
	2006-2007	<b>SEAT LEON</b>	2.0L L4 2000cc 122 CID			1999-2004	<b>HONDA ODYSSEY</b>	3.5L V6 3474cc										
	2006-2008	<b>SEAT IBIZA</b>	1.8L L4 1781cc 108 CID			2001-2002	<b>ACURA MDX</b>	3.5L V6 3471cc										
	2007	<b>AUDI TT</b>	2.0L L4 1998cc 122 CID			2001-2003	<b>ACURA CL</b>	3.2L V6 3210cc										
	2007	<b>SEAT LEON</b>	2.0L L4 1984cc 121 CID			2003-2004	<b>HONDA PILOT</b>	3.5L V6 3475cc										
	2007	<b>VOLKSWAGEN GLI</b>	2.0L L4 1984cc 121 CID			<b>US9384</b>	2011-2015	<b>SUBARU FORESTER</b>	2.5L H4 2498cc 152 CID									
	2007-2009	<b>AUDI A4</b>	1.8L L4 1781cc 108 CID				2012-2015	<b>SUBARU IMPREZA</b>	2.0L H4 1995cc									
	2008-2009	<b>SEAT ALTEA</b>	2.0L L4 1984cc 121 CID				2013-2015	<b>SUBARU BRZ</b>	2.0L H4 1998cc 122 CID									
	2008-2009	<b>SEAT LEON</b>	2.0L L4 1998cc 122 CID				2013-2015	<b>SUBARU LEGACY</b>	2.5L H4 2498cc 152 CID									
	2008-2010	<b>AUDI A3</b>	1.8L L4 1781cc 108 CID				2013-2015	<b>SUBARU OUTBACK</b>	2.5L H4 2498cc 152 CID									
	2008-2011	<b>AUDI S3 QUATTRO</b>	2.0L L4 1998cc 122 CID				2013-2015	<b>SUBARU XV CROSSTREK</b>	2.0L H4 1995cc									
	2009	<b>SEAT FREETRACK</b>	2.0L L4 1998cc 122 CID				2013-2016	<b>SCION FR-S</b>	2.0L H4 1998cc 122 CID									
	2009	<b>VOLKSWAGEN JETTA</b>	1.8L L4 1781cc 109 CID				2014	<b>SUBARU FORESTER</b>	2.5L L4 2498cc 152 CID									
	2009-2010	<b>SEAT LEON</b>	1.8L L4 1798cc 110 CID				2017	<b>TOYOTA 86</b>	2.0L H4 1998cc 122 CID									
	2010	<b>AUDI TT</b>	2.0L L4 1998cc 122 CID				<b>US9385</b>	1999-2005	<b>SUZUKI GRAND VITARA</b>	2.5L V6 2500cc								
	2010	<b>SEAT LEON</b>	2.0L L4 1984cc 121 CID					2001	<b>SUZUKI GRAND VITARA</b>	2.7L V6 2737cc								
	<b>US9378</b>	1998-2003	<b>VOLKSWAGEN BEETLE</b>					1.9L L4 1896cc 116 CID	2001-2004	<b>CHEVROLET TRACKER</b>	2.5L V6 2500cc							
		1999-2004	<b>VOLKSWAGEN GOLF</b>					1.9L L4 1896cc 116 CID	2002-2006	<b>SUZUKI XL-7</b>	2.7L V6 2737cc							
1999-2004		<b>VOLKSWAGEN JETTA</b>	1.9L L4 1896cc 116 CID	2004				<b>SUZUKI VITARA</b>	2.5L V6 2500cc									
2001		<b>SEAT IBIZA</b>	1.6L L4 1600cc 98 CID	2006-2008				<b>SUZUKI GRAND VITARA</b>	2.7L V6 2737cc									
2004		<b>SEAT IBIZA</b>	1.6L L4 1600cc 98 CID	<b>US9388</b>				1997-2001	<b>INFINITI Q45</b>	4.1L V8 4130cc								
2007		<b>SEAT CORDOBA</b>	1.6L L4 1600cc 98 CID					<b>US9389</b>	1997-1999	<b>MINISUBISHI MONTERO SPORT</b>	2.4L L4 2351cc							
2008		<b>VOLKSWAGEN JETTA</b>	1.9L L4 1896cc 116 CID						2008-2009	<b>DODGE VAN 1000</b>	2.4L L4 2429cc 148 CID							
2009		<b>VOLKSWAGEN EUROVAN</b>	1.9L L4 1896cc 116 CID						<b>US9393</b>	1998-2001	<b>KIA SEPIA</b>	1.8L L4 1793cc						
<b>US9379</b>		1998-1999	<b>MERCEDES-BENZ S430</b>							4.3L V8 4266cc 260 CID	2000-2004	<b>KIA SPECTRA</b>	1.8L L4 1793cc					
		1998-2000	<b>MERCEDES-BENZ C43 AMG</b>							4.3L V8 4266cc	<b>US9394</b>	1996-1998	<b>MAZDA MPV</b>	3.0L V6 2954cc 180 CID				
		1998-2000	<b>MERCEDES-BENZ C280</b>							2.8L V6 2799cc		<b>US9395</b>	1998-2004	<b>LEXUS GS300</b>	3.0L L6 2997cc			
		1998-2002	<b>MERCEDES-BENZ E430</b>							4.3L V8 4266cc			2001-2005	<b>LEXUS IS300</b>	3.0L L6 2997cc			
		1998-2003	<b>MERCEDES-BENZ ML320</b>							3.2L V6 3199cc			<b>US9399</b>	1999-2003	<b>MINISUBISHI GALANT</b>	2.4L L4 2351cc		
		1998-2005	<b>MERCEDES-BENZ CLK320</b>		3.2L V6 3199cc					1999-2005				<b>HYUNDAI SONATA</b>	2.4L L4 2351cc			
		1998-2005	<b>MERCEDES-BENZ E320</b>		3.2L V6 3199cc					2000-2005				<b>MINISUBISHI ECLIPSE</b>	2.4L L4 2351cc			
		1999-2003	<b>MERCEDES-BENZ CLK430</b>		4.3L V8 4266cc					2001-2004				<b>HYUNDAI SANTA FE</b>	2.4L L4 2351cc			
		2000	<b>MERCEDES-BENZ G500L</b>		5.0L V8 4973cc 303 CID					2001-2005				<b>CHRYSLER SEBRING</b>	2.4L L4 2351cc			
		2000-2005	<b>MERCEDES-BENZ CL500</b>		5.0L V8 4973cc					2001-2005				<b>DODGE STRATUS</b>	2.4L L4 2351cc			
		2000-2005	<b>MERCEDES-BENZ SL500</b>		5.0L V8 4973cc					2001-2006				<b>KIA OPTIMA</b>	2.4L L4 2351cc			
		2000-2006	<b>MERCEDES-BENZ S430</b>		4.3L V8 4266cc					2007-2009				<b>MINISUBISHI GRANDIS</b>	2.4L L4 2378cc 145 CID			
		2000-2006	<b>MERCEDES-BENZ S500</b>		5.0L V8 4966cc					2008-2012				<b>MINISUBISHI L200</b>	2.4L L4 2378cc 145 CID			
		2001-2004	<b>MERCEDES-BENZ SLK320</b>		3.2L V6 3199cc					<b>US9401</b>				1997-2000	<b>AUDI A4</b>	1.8L L4 1781cc		
		2001-2005	<b>MERCEDES-BENZ C240</b>		2.6L V6 2597cc	1997-2000								<b>AUDI A4 QUATTRO</b>	1.8L L4 1781cc			
		2001-2005	<b>MERCEDES-BENZ C320</b>		3.2L V6 3199cc	1998-2000								<b>VOLKSWAGEN PASSAT</b>	1.8L L4 1781cc			
		2002-2004	<b>MERCEDES-BENZ G500</b>		5.0L V8 4966cc	<b>US9402</b>								1999-2002	<b>MERCURY VILLAGER</b>	3.3L V6 3275cc		
		2003-2005	<b>MERCEDES-BENZ CLK500</b>		5.0L V8 4973cc									1999-2002	<b>NISSAN QUEST</b>	3.3L V6 3275cc		
		2003-2005	<b>MERCEDES-BENZ E500</b>		5.0L V8 4973cc									<b>US9403</b>	2000-2003	<b>HONDA S2000</b>	2.0L L4 1997cc	
		2003-2005	<b>MERCEDES-BENZ ML350</b>		3.7L V6 3699cc										2004-2009	<b>HONDA S2000</b>	2.2L L4 2157cc	
		2004-2006	<b>MERCEDES-BENZ E500</b>		5.0L V8 4966cc										<b>US9405</b>	2000-2005	<b>TOYOTA CELICA</b>	1.8L L4 1795cc
		2004-2008	<b>CHRYSLER CROSSFIRE</b>		3.2L V6 3200cc 195 CID											2003-2006	<b>PONTIAC VIBE</b>	1.8L L4 1795cc
		2005	<b>MERCEDES-BENZ G500</b>		5.0L V8 4973cc											2003-2006	<b>TOYOTA MATRIX</b>	1.8L L4 1795cc
		2005-2006	<b>CHRYSLER CROSSFIRE</b>		3.2L V6 3199cc		2005-2006									<b>TOYOTA COROLLA</b>	1.8L L4 1795cc	
		2006	<b>MERCEDES-BENZ CL500</b>		5.0L V8 4966cc		<b>US9406</b>									2000-2005	<b>TOYOTA ECHO</b>	1.5L L4 1497cc
	2006	<b>MERCEDES-BENZ CLK500</b>	5.0L V8 4966cc		2001-2009											<b>TOYOTA PRIUS</b>	1.5L L4 1497cc	
	2006	<b>MERCEDES-BENZ CLS500</b>	5.0L V8 4966cc		2004-2005											<b>TOYOTA YARIS</b>	1.3L L4 1295cc 79 CID	
	2006	<b>MERCEDES-BENZ R500</b>	5.0L V8 4966cc		2004-2006											<b>SCION XA</b>	1.5L L4 1497cc	
	2006	<b>MERCEDES-BENZ S350</b>	3.7L V6 3724cc		2004-2006											<b>SCION XB</b>	1.5L L4 1497cc	
	2006	<b>MERCEDES-BENZ SL500</b>	5.0L V8 4966cc	2006	<b>TOYOTA YARIS</b>											1.5L L4 1497cc 91 CID		
	2006-2008	<b>MERCEDES-BENZ G500</b>	5.0L V8 4966cc	2007-2011	<b>TOYOTA AVANZA</b>			1.5L L4 1497cc 91 CID										
	2007	<b>MERCEDES-BENZ CLS500</b>	5.0L V8 4966cc 303 CID	2007-2017	<b>TOYOTA YARIS</b>			1.5L L4 1497cc										
	2007	<b>MERCEDES-BENZ R500</b>	5.0L V8 4973cc	2011	<b>TOYOTA YARIS</b>			1.5L L4 1497cc 91 CID										
2007-2009	<b>MERCEDES-BENZ CLK500</b>	5.0L V8 4966cc 303 CID	2015-2016	<b>TOYOTA YARIS</b>	1.5L L4 1497cc 91 CID													
<b>US9380</b>	1998-2002	<b>MERCEDES-BENZ CLK320</b>	3.2L V6 3199cc	<b>US9410</b>	2000-2004			<b>AUDI A6 QUATTRO</b>	4.2L V8 4172cc									
	1998-2005	<b>MERCEDES-BENZ E320</b>	3.2L V6 3199cc		2000-2006			<b>AUDI A8 QUATTRO</b>	4.2L V8 4172cc									
	1999-2001	<b>MERCEDES-BENZ ML430</b>	4.3L V8 4266cc		2001			<b>AUDI S6 QUATTRO</b>	4.2L V8 4172cc 255 CID									
	1999-2002	<b>MERCEDES-BENZ E55 AMG</b>	5.5L V8 5439cc 335 CID		2001-2003			<b>AUDI S8</b>	4.2L V8 4172cc									
	2000-2003	<b>MERCEDES-BENZ ML55 AMG</b>	5.5L V8 5439cc 335 CID		2002-2003			<b>AUDI S6</b>	4.2L V8 4172cc									
	2001	<b>MERCEDES-BENZ G500L</b>	5.0L V8 4973cc 303 CID		2003			<b>AUDI RS6</b>	4.2L V8 4172cc									
	2001-2002	<b>MERCEDES-BENZ CL55 AMG</b>	5.5L V8 5439cc 335 CID		2004			<b>AUDI RS6 QUATTRO</b>	4.2L V8 4179cc 255 CID									
	2001-2002	<b>MERCEDES-BENZ S55 AMG</b>	5.5L V8 5439cc 335 CID		2004			<b>AUDI S6 QUATTRO</b>	4.2L V8 4172cc 255 CID									
	2001-2003	<b>MERCEDES-BENZ SLK320</b>	3.2L V6 3199cc		2004-2006			<b>VOLKSWAGEN PHAETON</b>	4.2L V8 4172cc									
	2001-2006	<b>MERCEDES-BENZ CLK55 AMG</b>	5.5L V8 5439cc 335 CID		2004-2007			<b>VOLKSWAGEN TOUAREG</b>	4.2L V8 4172cc									
	2002	<b>MERCEDES-BENZ ML500</b>	5.0L V8 4966cc		2008-2009			<b>AUDI Q7</b>	4.2L V8 4163cc 254 CID									
	2002-2004	<b>MERCEDES-BENZ G500</b>	5.0L V8 4966cc		<b>US9414</b>			2001-2003	<b>TOYOTA RAV4</b>		2.0L L4 1998cc 122 CID							
	2003-2004	<b>MERCEDES-BENZ G55 AMG</b>	5.5L V8 5439cc 335 CID					2001-2007	<b>TOYOTA HIGHLANDER</b>	2.4L L4 2362cc								
	2003-2005	<b>MERCEDES-BENZ ML500</b>	5.0L V8 4966cc 303 CID					2002-2008	<b>TOYOTA SOLARA</b>	2.4L L4 2362cc								
	2005	<b>MERCEDES-BENZ G500</b>	5.0L V8 4973cc					2002-2011	<b>TOYOTA CAMRY</b>	2.4L L4 2362cc								
	2005-2006	<b>MERCEDES-BENZ C55 AMG</b>	5.5L V8 5439cc 335 CID			2004-2008		<b>TOYOTA RAV4</b>	2.4L L4 2362cc									

USMW	Years	Application	Engine	USMW	Years	Application	Engine
<b>US9414</b>	2005-2009	<b>SCION TC</b>	2.4L L4 2398cc	<b>US9462</b>	2003-2008	<b>HYUNDAI TIBURON</b>	2.7L V6 2656cc
	2009-2010	<b>PONTIAC VIBE</b>	2.4L L4 2362cc		2005-2009	<b>HYUNDAI TUCSON</b>	2.7L V6 2656cc
	2009-2010	<b>TOYOTA COROLLA</b>	2.4L L4 2362cc	2005-2010	<b>KIA SPORTAGE</b>	2.7L V6 2656cc	
	2009-2013	<b>TOYOTA MATRIX</b>	2.4L L4 2362cc	<b>US9463</b>	2001	<b>HYUNDAI XG300</b>	3.0L V6 2972cc
	2010	<b>SCION TC</b>	2.4L L4 2362cc		2002-2005	<b>HYUNDAI XG350</b>	3.5L V6 3500cc
2010-2012	<b>LEXUS HS250H</b>	2.4L L4 2362cc	2002-2005		<b>KIA SEDONA</b>	3.5L V6 3497cc	
2011-2015	<b>SCION XB</b>	2.4L L4 2362cc	2003-2005	<b>HYUNDAI SANTA FE</b>	3.5L V6 3500cc		
<b>US9415</b>	2001-2002	<b>MINI COOPER</b>	1.8L L4 1809cc	2004-2006	<b>KIA AMANTI</b>	3.5L V6 3497cc	
	2003-2005	<b>MINI COOPER</b>	1.8L L4 1809cc	2006	<b>HYUNDAI SANTA FE</b>	3.5L V6 3467cc	
<b>US9416</b>	2000-2006	<b>NISSAN SENTRA</b>	1.8L L4 1769cc 107 CID	<b>US9464</b>	1995-1997	<b>BMW 850CI</b>	5.4L V12 5379cc
	2001	<b>NISSAN ALMERA</b>	1.8L L4 1781cc 108 CID		1995-1998	<b>BMW 750IL</b>	5.4L V12 5379cc
<b>US9419</b>	2002-2004	<b>HONDA CIVIC</b>	1.7L L4 1668cc	1998	<b>BMW 850CI</b>	5.4L V12 5379cc 328 CID	
	2005	<b>HONDA CIVIC</b>	1.7L L4 1668cc	<b>US9465</b>	1999-2001	<b>BMW 740I</b>	4.4L V8 4398cc
<b>US9421</b>	2001-2009	<b>SUBARU OUTBACK</b>	3.0L H6 3000cc		1999-2001	<b>BMW 740IL</b>	4.4L V8 4398cc
	2006-2007	<b>SUBARU B9 TRIBECA</b>	3.0L H6 3000cc	1999-2003	<b>BMW 540I</b>	4.4L V8 4398cc	
<b>US9426</b>	2008-2009	<b>SUBARU LEGACY</b>	3.0L H6 3000cc	2000-2003	<b>BMW X5</b>	4.4L V8 4398cc	
	2014	<b>SUBARU LEGACY</b>	3.6L H6 3630cc 222 CID	2002-2003	<b>BMW X5</b>	4.6L V8 4598cc	
<b>US9427</b>	2002-2004	<b>INFINITI I35</b>	3.5L V6 3498cc	2003	<b>BMW Z8</b>	4.8L V8 4837cc	
	2002-2006	<b>INFINITI ALTIMA</b>	3.5L V6 3498cc	<b>US9467</b>	1998-2001	<b>BMW 750IL</b>	5.4L V12 5379cc
2002-2008	<b>INFINITI MAXIMA</b>	3.5L V6 3498cc	<b>US9468</b>		1996-1997	<b>HONDA CIVIC DEL SOL</b>	1.6L L4 1595cc
2003	<b>NISSAN 350Z</b>	3.5L V6 3498cc		1996-2001	<b>ACURA INTEGRA</b>	1.8L L4 1797cc	
2003-2006	<b>NISSAN 350Z</b>	3.5L V6 3498cc	1999-2000	<b>HONDA CIVIC</b>	1.6L L4 1590cc 97 CID		
2003-2007	<b>INFINITI FX35</b>	3.5L V6 3498cc	1999-2000	<b>HONDA CIVIC</b>	1.6L L4 1595cc		
2003-2007	<b>INFINITI G35</b>	3.5L V6 3498cc	<b>US9470</b>	2003-2006	<b>ACURA MDX</b>	3.5L V6 3471cc	
2003-2007	<b>NISSAN MURANO</b>	3.5L V6 3498cc		2003-2007	<b>HONDA ACCORD</b>	3.0L V6 2997cc	
2004-2009	<b>NISSAN QUEST</b>	3.5L V6 3498cc	2004	<b>SATURN VUE</b>	3.5L V6 3475cc		
2005-2012	<b>NISSAN PATHFINDER</b>	4.0L V6 3954cc	2004-2005	<b>SATURN VUE</b>	3.5L V6 3474cc		
2005-2015	<b>NISSAN XTERRA</b>	4.0L V6 3954cc	2004-2008	<b>ACURA TL</b>	3.2L V6 3210cc		
2005-2017	<b>NISSAN FRONTIER</b>	4.0L V6 3954cc	2005-2008	<b>ACURA RL</b>	3.5L V6 3471cc		
2006-2007	<b>INFINITI M35</b>	3.5L V6 3498cc	2005-2017	<b>HONDA ODYSSEY</b>	3.5L V6 3471cc		
2008	<b>NISSAN FRONTIER</b>	4.0L V6 3954cc 241 CID	2005-2017	<b>HONDA PILOT</b>	3.5L V6 3471cc		
2008	<b>NISSAN MURANO</b>	4.0L V6 3954cc	2006-2007	<b>SATURN VUE</b>	3.5L V6 3471cc		
2009-2012	<b>SUZUKI EQUATOR</b>	4.0L V6 3954cc	2006-2014	<b>HONDA RIDGELINE</b>	3.5L V6 3471cc		
2010	<b>NISSAN MAXIMA</b>	3.5L H6 3500cc 213 CID	2007-2013	<b>ACURA MDX</b>	3.7L V6 3664cc		
2010-2011	<b>NISSAN PATHFINDER</b>	4.0L V6 3954cc 241 CID	2007-2014	<b>ACURA TL</b>	3.5L V6 3471cc		
2010-2012	<b>NISSAN FRONTIER</b>	4.0L V6 3954cc 241 CID	2008-2017	<b>HONDA ACCORD</b>	3.5L V6 3471cc		
2012-2017	<b>NISSAN NV1500</b>	4.0L V6 3954cc	2009-2012	<b>ACURA RL</b>	3.7L V6 3664cc		
2012-2017	<b>NISSAN NV2500</b>	4.0L V6 3954cc	2009-2014	<b>ACURA TL</b>	3.7L V6 3664cc		
2012-2017	<b>NISSAN NV3500</b>	4.0L V6 3954cc	2010-2011	<b>HONDA ACCORD CROSSTOUR</b>	3.5L V6 3471cc		
2014-2015	<b>NISSAN FRONTIER</b>	4.0L V6 3954cc 241 CID	2010-2013	<b>ACURA ZDX</b>	3.7L V6 3664cc		
<b>US9427</b>	2002-2010	<b>NISSAN X-TRAIL</b>	2.5L L4 2488cc 152 CID	2010-2014	<b>ACURA TSX</b>	3.5L V6 3471cc	
	2002-2012	<b>NISSAN SENTRA</b>	2.5L L4 2488cc 152 CID	2012-2015	<b>HONDA CROSSTOUR</b>	3.5L V6 3471cc	
<b>US9427-2</b>	2002-2013	<b>NISSAN ALTIMA</b>	2.5L L4 2488cc 152 CID	2013-2017	<b>ACURA RDX</b>	3.5L V6 3471cc	
	2008-2013	<b>NISSAN ROGUE</b>	2.5L L4 2488cc 152 CID	2014-2017	<b>ACURA MDX</b>	3.5L V6 3471cc	
<b>US9429</b>	2014-2015	<b>NISSAN ROGUE SELECT</b>	2.5L L4 2488cc 152 CID	2014-2017	<b>ACURA RLX</b>	3.5L V6 3471cc	
	2002-2004	<b>AUDI A6</b>	3.0L V6 2976cc	2015-2017	<b>ACURA TLX</b>	3.5L V6 3471cc	
<b>US9434</b>	2002-2004	<b>AUDI A6 QUATTRO</b>	3.0L V6 2976cc	2017	<b>ACURA MDX</b>	3.0L V6 2997cc	
	2002-2005	<b>AUDI A4</b>	3.0L V6 2976cc	2017	<b>HONDA RIDGELINE</b>	3.5L V6 3471cc	
<b>US9440</b>	2002-2006	<b>AUDI A4 QUATTRO</b>	3.0L V6 2976cc	<b>US9471</b>	2002-2003	<b>VOLKSWAGEN EUROVAN</b>	2.8L V6 2792cc
	2005-2006	<b>AUDI A6</b>	3.0L V6 2976cc 182 CID		2002-2004	<b>VOLKSWAGEN JETTA</b>	2.8L V6 2792cc
<b>US9446</b>	2008-2009	<b>AUDI A6</b>	2.8L V6 2773cc	2002-2005	<b>VOLKSWAGEN GOLF</b>	2.8L V6 2792cc	
	2002-2005	<b>HONDA CIVIC</b>	2.0L L4 1998cc 122 CID	2004	<b>VOLKSWAGEN GOLF</b>	3.2L V6 3189cc	
<b>US9448</b>	2002-2006	<b>ACURA RSX</b>	2.0L L4 1998cc 122 CID	2004-2005	<b>VOLKSWAGEN TOUAREG</b>	3.2L V6 3200cc 195 CID	
	2002-2006	<b>HONDA CR-V</b>	2.4L L4 2354cc 144 CID	2004-2006	<b>AUDI A3</b>	3.2L V6 3189cc 195 CID	
<b>US9449</b>	1999-2000	<b>MERCEDES-BENZ C230</b>	2.3L L4 2295cc	2004-2006	<b>AUDI TT QUATTRO</b>	3.2L V6 3189cc 195 CID	
	2000-2002	<b>AUDI S4</b>	2.7L V6 2671cc	2005-2007	<b>PORSCHE CAYENNE</b>	3.2L V6 3189cc 195 CID	
<b>US9454</b>	2000-2004	<b>AUDI A6 QUATTRO</b>	2.7L V6 2671cc	2006-2009	<b>VOLKSWAGEN TOUAREG</b>	3.2L V6 3189cc 195 CID	
	2001-2005	<b>AUDI ALLROAD QUATTRO</b>	2.7L V6 2671cc	2006-2009	<b>AUDI A3 QUATTRO</b>	3.2L V6 3189cc 195 CID	
<b>US9455</b>	2003-2006	<b>KIA SORENTO</b>	3.5L V6 3497cc	2007-2008	<b>VOLKSWAGEN EOS</b>	3.2L V6 3189cc 195 CID	
	2011-2018	<b>FORD FIESTA</b>	1.6L L4 1596cc 97 CID	2008	<b>AUDI A5</b>	3.2L V6 3200cc 195 CID	
<b>US9456</b>	2013-2014	<b>FORD FUSION</b>	1.6L L4 1596cc 97 CID	2008	<b>AUDI Q7</b>	3.0L V6 2967cc 182 CID	
	2013-2016	<b>FORD ESCAPE</b>	1.6L L4 1601cc 98 CID	2008	<b>VOLKSWAGEN EOS</b>	3.2L V6 3197cc 195 CID	
<b>US9460</b>	2014-2016	<b>FORD TRANSIT CONNECT</b>	1.6L L4 1596cc 97 CID	2008	<b>VOLKSWAGEN R32</b>	3.2L V6 3189cc 195 CID	
	1995-2002	<b>KIA SPORTAGE</b>	2.0L L4 1998cc 122 CID	2008-2009	<b>AUDI TT QUATTRO</b>	3.2L V6 3189cc 195 CID	
<b>US9461</b>	2003-2005	<b>VOLVO S80</b>	2.9L L6 2917cc	2002-2005	<b>SUBARU FORESTER</b>	2.5L H4 2458cc	
	2003-2005	<b>VOLVO XC90</b>	2.9L L6 2917cc	2001-2002	<b>KIA RIO</b>	1.5L L4 1493cc	
<b>US9462</b>	1995-1996	<b>MINI COOPER</b>	1.8L L4 1809cc	2003-2005	<b>KIA RIO</b>	1.6L L4 1594cc	
	1996-2000	<b>MINI COOPER</b>	1.8L L4 1809cc	2002-2008	<b>MINI COOPER</b>	1.6L L4 1600cc	
<b>US9463</b>	1997-2003	<b>MINI COOPER</b>	1.8L L4 1809cc	<b>US9472</b>	1997-1999	<b>PORSCHE BOXSTER</b>	2.5L H6 2480cc
	1999-2004	<b>MINI COOPER</b>	1.8L L4 1809cc		1999-2001	<b>PORSCHE 911</b>	3.4L H6 3400cc
<b>US9464</b>	2003-2007	<b>HONDA ACCORD</b>	2.4L L4 2354cc 144 CID	2000	<b>PORSCHE BOXSTER</b>	2.5L H6 2480cc 151 CID	
	2003-2011	<b>HONDA ELEMENT</b>	2.4L L4 2354cc 144 CID	2000-2006	<b>PORSCHE BOXSTER</b>	3.2L H6 3179cc	
<b>US9465</b>	2004-2008	<b>ACURA TSX</b>	2.4L L4 2354cc 144 CID	2000-2008	<b>PORSCHE BOXSTER</b>	2.7L H6 2687cc	
	2007-2009	<b>HONDA CR-V</b>	2.4L L4 2354cc 144 CID	2002-2009	<b>PORSCHE 911</b>	3.6L H6 3596cc	
<b>US9466</b>	1999-2001	<b>HYUNDAI SONATA</b>	2.5L V6 2493cc	2005-2008	<b>PORSCHE 911</b>	3.8L H6 3824cc	
	2001	<b>KIA OPTIMA</b>	2.5L V6 2500cc	2006-2008	<b>PORSCHE CAYMAN</b>	3.4L H6 3387cc	
<b>US9467</b>	2001-2006	<b>HYUNDAI SANTA FE</b>	2.7L V6 2656cc	2007-2008	<b>PORSCHE 911</b>	3.6L H6 3598cc	
	2002-2005	<b>HYUNDAI SONATA</b>	2.7L V6 2656cc	2007-2008	<b>PORSCHE BOXSTER</b>	3.4L H6 3387cc	
<b>US9468</b>	2002-2006	<b>KIA OPTIMA</b>	2.7L V6 2656cc	2007-2008	<b>PORSCHE CAYMAN</b>	2.7L H6 2687cc	
	2002-2006	<b>KIA OPTIMA</b>	2.7L V6 2656cc	2010-2011	<b>PORSCHE 911</b>	3.8L H6 3800cc	
<b>US9469</b>	2003-2007	<b>HONDA ACCORD</b>	2.4L L4 2354cc 144 CID	2011	<b>PORSCHE 911</b>	3.6L H6 3600cc 220 CID	
	2003-2011	<b>HONDA ELEMENT</b>	2.4L L4 2354cc 144 CID	2011	<b>PORSCHE 911</b>	4.0L H6 3996cc	
<b>US9470</b>	2004-2008	<b>ACURA TSX</b>	2.4L L4 2354cc 144 CID	<b>US9480</b>	1980-1985	<b>PEUGEOT 505</b>	2.3L L4 2304cc
	2007-2009	<b>HONDA CR-V</b>	2.4L L4 2354cc 144 CID		1980-1987	<b>PEUGEOT 505</b>	2.0L L4 1971cc
<b>US9471</b>	1999-2001	<b>HYUNDAI SONATA</b>	2.5L V6 2493cc	1985-1991	<b>PEUGEOT 505</b>	2.2L L4 2155cc	
	2001	<b>KIA OPTIMA</b>	2.5L V6 2500cc	<b>US9486</b>	1987-1994	<b>SUBARU JUSTY</b>	1.2L L3 1189cc
2001-2006	<b>HYUNDAI SANTA FE</b>	2.7L V6 2656cc	<b>US9488</b>		2004	<b>NISSAN PATHFINDER ARMADA</b>	5.6L V8 5552cc
2002-2005	<b>HYUNDAI SONATA</b>	2.7L V6 2656cc		2004-2013	<b>INFINITI QX56</b>	5.6L V8 5552cc	
2002-2006	<b>KIA OPTIMA</b>	2.7L V6 2656cc	2004-2015	<b>NISSAN TITAN</b>	5.6L V8 5552cc		



USMW	Years	Application	Engine	USMW	Years	Application	Engine		
<b>US9488</b>	2005-2015	NISSAN ARMADA	5.6L V8 5552cc	<b>US11009</b>	2003-2006	MERCEDES-BENZ E55 AMG	5.5L V8 5439cc 335 CID		
	2008-2012	NISSAN PATHFINDER	5.6L V8 5552cc		2004-2006	MERCEDES-BENZ E500	5.0L V8 4966cc		
	2009-2013	INFINITI FX50	5.0L V8 5026cc		2005-2006	MERCEDES-BENZ E320	3.2L L6 3222cc		
	2011-2013	INFINITI M56	5.6L V8 5552cc		2006	MERCEDES-BENZ CLS55 AMG	5.5L V8 5439cc 335 CID		
	2012-2017	NISSAN NV2500	5.6L V8 5552cc		2006	MERCEDES-BENZ CLS500	5.0L V8 4966cc		
	2012-2017	NISSAN NV3500	5.6L V8 5552cc		2006	MERCEDES-BENZ ML500	5.0L V8 4966cc		
	2014	INFINITI QX70	5.0L V8 5026cc		2006	MERCEDES-BENZ R500	5.0L V8 4966cc		
	2014-2015	INFINITI QX80	5.6L V8 5552cc 339 CID		2006-2009	MERCEDES-BENZ E350	3.5L V6 3498cc		
	2014-2017	INFINITI Q70	5.6L V8 5552cc		2006-2011	MERCEDES-BENZ ML350	3.5L V6 3498cc		
	2014-2017	INFINITI QX80	5.6L V8 5552cc		2006-2012	MERCEDES-BENZ R350	3.5L V6 3498cc		
	2015-2017	INFINITI Q70L	5.6L V8 5552cc		2007	MERCEDES-BENZ ML500	5.0L V8 4973cc		
	2016-2017	NISSAN TITAN XD	5.6L V8 5552cc		2007	MERCEDES-BENZ R63 AMG	6.3L V8 6208cc		
	2017	NISSAN ARMADA	5.6L V8 5552cc		2007	MERCEDES-BENZ R500	5.0L V8 4973cc		
	2017	NISSAN TITAN	5.6L V8 5552cc		2007-2009	MERCEDES-BENZ E63 AMG	6.3L V8 6208cc		
	<b>US9489</b>	2003-2008	MAZDA 6		3.0L V6 2968cc 181 CID	2007-2009	MERCEDES-BENZ E320	3.0L V6 2987cc	
		2006	LINCOLN ZEPHYR		3.0L V6 2968cc 181 CID	2007-2009	MERCEDES-BENZ E550	5.5L V8 5461cc	
		2006-2008	FORD ESCAPE		3.0L V6 2968cc 181 CID	2007-2009	MERCEDES-BENZ GL320	3.0L V6 2987cc	
2006-2008		MERCURY MARINER	3.0L V6 2968cc 181 CID	2007-2009	MERCEDES-BENZ ML320	3.0L V6 2987cc			
2006-2009		FORD FUSION	3.0L V6 2968cc 181 CID	2007-2009	MERCEDES-BENZ R320	3.0L V6 2987cc			
2006-2009		MERCURY MILAN	3.0L V6 2968cc 181 CID	2007-2011	MERCEDES-BENZ CLS63 AMG	6.3L V8 6208cc			
<b>US9489-2</b>		2006	LINCOLN ZEPHYR	3.0L V6 2968cc 181 CID	2007-2011	MERCEDES-BENZ CLS550	5.5L V8 5461cc		
		2006-2008	FORD ESCAPE	3.0L V6 2968cc 181 CID	2007-2011	MERCEDES-BENZ ML63 AMG	6.3L V8 6208cc		
		2006-2008	MERCURY MARINER	3.0L V6 2968cc 181 CID	2007-2012	MERCEDES-BENZ GL450	4.6L V8 4663cc		
		2006-2009	FORD FUSION	3.0L V6 2968cc 181 CID	2008-2011	MERCEDES-BENZ ML550	5.5L V8 5461cc		
	2006-2009	MERCURY MILAN	3.0L V6 2968cc 181 CID	2008-2012	MERCEDES-BENZ GL550	5.5L V8 5461cc			
<b>US9493</b>	1977-1979	TOYOTA LAND CRUISER	4.2L L6 4227cc	2010-2011	MERCEDES-BENZ ML350	3.0L V6 2987cc			
<b>US9494</b>	2000-2006	HONDA INSIGHT	1.0L L3 995cc 61 CID	2010-2011	MERCEDES-BENZ ML450	3.5L V6 3498cc			
<b>US9495</b>	2006-2011	HONDA CIVIC	2.0L L4 1998cc 122 CID	2010-2012	MERCEDES-BENZ GL350				
<b>US9496</b>	2000	ROVER 75	2.5L V6 2497cc 152 CID	2010-2012	MERCEDES-BENZ R350	3.0L V6 2987cc			
	2002-2005	LAND ROVER FREELANDER	2.5L V6 2500cc 153 CID	2012	MERCEDES-BENZ ML63 AMG	5.5L V8 5461cc			
	2003-2005	ROVER 75	2.5L V6 2497cc 152 CID	2013-2014	MERCEDES-BENZ G63 AMG	5.5L V8 5461cc			
<b>US11001</b>	2009-2011	MERCURY MARINER	2.5L L4 2488cc 152 CID	2014	MERCEDES-BENZ SPRINTER 2500	2.1L L4 2143cc 131 CID			
	2009-2012	FORD ESCAPE	2.5L L4 2488cc 152 CID	2014	MERCEDES-BENZ SPRINTER 3500	2.1L L4 2143cc 131 CID			
<b>US11002</b>	2005-2008	FORD ESCAPE	2.3L L4 140 CID	<b>US11011</b>	2004-2009	TOYOTA PRIUS	1.5L L4 1497cc		
	2006-2008	MERCURY MARINER	2.3L L4 140 CID	<b>US11012</b>	2007-2011	TOYOTA CAMRY	2.4L L4 2362cc		
	2011	FORD ESCAPE	2.5L L4 2488cc 152 CID	<b>US11013</b>	2004-2009	TOYOTA PRIUS	1.5L L4 1497cc		
<b>US11003</b>	2000-2002	AUDI A6 QUATTRO	2.7L V6 2671cc	<b>US11014</b>	1999-2003	FORD F-150	5.4L V8 330 CID		
	2000-2002	AUDI S4	2.7L V6 2671cc	2003-2004	FORD MUSTANG	4.6L V8 281 CID			
	2001-2002	AUDI ALLROAD QUATTRO	2.7L V6 2671cc	2004	FORD F-150 HERITAGE	5.4L V8 330 CID			
	2001-2006	AUDI TT QUATTRO	1.8L L4 1781cc	<b>US11015</b>	2002-2004	MERCEDES-BENZ C32 AMG	3.2L V6 3199cc		
	2002-2005	VOLKSWAGEN JETTA	1.8L L4 1781cc		2002-2004	MERCEDES-BENZ SLK32 AMG	3.2L V6 3199cc		
	2002-2006	AUDI TT	1.8L L4 1781cc		2003-2006	MERCEDES-BENZ E55 AMG	5.5L V8 5439cc 335 CID		
	2002-2006	VOLKSWAGEN GOLF	1.8L L4 1781cc		2003-2013	MERCEDES-BENZ S600	5.5L V12 5513cc 336 CID		
	<b>US11004</b>	2000-2003	VOLKSWAGEN EUROVAN		2.8L V6 2792cc	2003-2014	MERCEDES-BENZ CL600	5.5L V12 5513cc 336 CID	
		2000-2004	VOLKSWAGEN JETTA		2.8L V6 2792cc	2004-2009	MERCEDES-BENZ SL600	5.5L V12 5513cc 336 CID	
		2000-2005	VOLKSWAGEN GOLF		2.8L V6 2792cc	2005-2006	MERCEDES-BENZ CL65 AMG	6.0L V12 5980cc 365 CID	
		2002-2004	VOLKSWAGEN PASSAT		4.0L V8 3998cc 244 CID	2005-2009	MERCEDES-BENZ SLR MCLAREN	5.5L V8 5439cc 335 CID	
		2003-2004	AUDI A6 QUATTRO		2.7L V6 2671cc	2005-2011	MERCEDES-BENZ G55 AMG	5.5L V8 5439cc 335 CID	
		2003-2005	AUDI ALLROAD QUATTRO		2.7L V6 2671cc	2005-2011	MERCEDES-BENZ SL65 AMG	6.0L V12 5980cc 365 CID	
		2004	VOLKSWAGEN GOLF	3.2L V6 3189cc	2006	MERCEDES-BENZ CLS55 AMG	5.5L V8 5439cc 335 CID		
2004		VOLKSWAGEN PHAETON	6.0L W12 6000cc	2006	MERCEDES-BENZ S65 AMG	6.0L V12 5980cc 365 CID			
2004-2005		VOLKSWAGEN TOUAREG	3.2L V6 3200cc 195 CID	2006-2007	MERCEDES-BENZ C280	3.0L V6 2996cc			
2004-2006		AUDI TT QUATTRO	3.2L V6 3189cc 195 CID	2006-2007	MERCEDES-BENZ C350	3.5L V6 3498cc			
2004-2006	VOLKSWAGEN TOUAREG	3.2L V6 3189cc 195 CID	2007	MERCEDES-BENZ R63 AMG	6.3L V8 6208cc				
2006	VOLKSWAGEN PHAETON	6.0L W12 5998cc 366 CID	2007-2011	MERCEDES-BENZ ML63 AMG	6.3L V8 6208cc				
2006-2009	AUDI A3 QUATTRO	3.2L V6 3189cc 195 CID	2008-2010	MERCEDES-BENZ CL63 AMG	6.3L V8 6208cc				
2007-2008	VOLKSWAGEN EOS	3.2L V6 3189cc 195 CID	2008-2014	MERCEDES-BENZ CL65 AMG	6.0L V12 5980cc 365 CID				
2007-2009	VOLKSWAGEN TOUAREG	4.2L V8 4163cc	2010-2011	MERCEDES-BENZ ML450	3.5L V6 3498cc				
2007-2010	AUDI Q7	3.6L V6 3597cc 219 CID	2011-2013	MERCEDES-BENZ S63 AMG	5.5L V8 5461cc				
2007-2010	VOLKSWAGEN TOUAREG	3.6L V6 3597cc 219 CID	2011-2014	MERCEDES-BENZ CL550	4.6L V8 4663cc				
2008	VOLKSWAGEN EOS	3.2L V6 3197cc 195 CID	2012-2013	MERCEDES-BENZ S550	4.6L V8 4663cc				
2008	VOLKSWAGEN R32	3.2L V6 3189cc 195 CID	2012-2014	MERCEDES-BENZ CLS63 AMG	5.5L V8 5461cc				
2008-2009	AUDI TT QUATTRO	3.2L V6 3189cc 195 CID	2012-2014	MERCEDES-BENZ CLS550	4.6L V8 4663cc				
2008-2012	AUDI R8	4.2L V8 4163cc	2012-2014	MERCEDES-BENZ E63 AMG	5.5L V8 5461cc				
2010-2012	AUDI R8	5.2L V10 5204cc	2012-2014	MERCEDES-BENZ CLS63 AMG	5.5L V8 5461cc				
2014	AUDI R8	4.2L V8 4163cc	2012-2014	MERCEDES-BENZ CLS550	4.6L V8 4663cc				
2014	AUDI R8	5.2L V10 5204cc	2012-2014	MERCEDES-BENZ E63 AMG	5.5L V8 5461cc				
<b>US11005</b>	2005-2012	NISSAN PATHFINDER	4.0L V6 3954cc	2012-2014	MERCEDES-BENZ CLS550	4.6L V8 4663cc			
<b>US11006</b>	2008-2010	FORD F-250 SUPER DUTY	6.4L V8 391 CID	2012-2014	MERCEDES-BENZ E63 AMG	5.5L V8 5461cc			
	2008-2010	FORD F-350 SUPER DUTY	6.4L V8 391 CID	2012-2014	MERCEDES-BENZ E550	4.6L V8 4663cc			
	2008-2010	FORD F-450 SUPER DUTY	6.4L V8 391 CID	2012-2014	MERCEDES-BENZ ML63 AMG	5.5L V8 5461cc			
	2008-2010	FORD F-550 SUPER DUTY	6.4L V8 391 CID	2013-2014	MERCEDES-BENZ GL63 AMG	5.5L V8 5461cc 333 CID			
	2010	FORD F-550 SUPER DUTY	6.4L V8 6400cc 391 CID	2013-2014	MERCEDES-BENZ GL450	4.6L V8 4663cc			
<b>US11007</b>	2009-2011	MERCURY MARINER	2.5L L4 2488cc 152 CID	2013-2014	MERCEDES-BENZ GL550	4.6L V8 4663cc			
	2009-2012	FORD ESCAPE	2.5L L4 2488cc 152 CID	2013-2014	MERCEDES-BENZ SL550	4.6L V8 4663cc			
<b>US11008</b>	2008-2010	VOLKSWAGEN JETTA	2.0L L4 1984cc 121 CID	2014	MERCEDES-BENZ E63 AMG S	5.5L V8 5461cc			
	2008-2010	VOLKSWAGEN PASSAT	2.0L L4 1984cc 121 CID	2014	MERCEDES-BENZ ML550	4.6L V8 4663cc			
	2008-2013	AUDI A3	2.0L L4 1984cc 121 CID	<b>US11017</b>	2006-2008	AUDI A3	2.0L L4 1984cc 121 CID		
	2008-2014	VOLKSWAGEN GTI	2.0L L4 1984cc 121 CID		2006-2008	VOLKSWAGEN GTI	2.0L L4 1984cc 121 CID		
	2009	AUDI TT	2.0L L4 1984cc 121 CID		2006-2008	VOLKSWAGEN JETTA	2.0L L4 1984cc 121 CID		
	2009-2013	AUDI A3 QUATTRO	2.0L L4 1984cc 121 CID		2006-2008	VOLKSWAGEN PASSAT	2.0L L4 1984cc 121 CID		
	2009-2014	AUDI TT QUATTRO	2.0L L4 1984cc 121 CID		2007-2009	VOLKSWAGEN EOS	2.0L L4 1984cc 121 CID		
	2009-2014	VOLKSWAGEN CC	2.0L L4 1984cc 121 CID		2008-2009	AUDI TT	2.0L L4 1984cc 121 CID		
	2009-2014	VOLKSWAGEN EOS	2.0L L4 1984cc 121 CID		2009-2010	AUDI A5 QUATTRO	3.2L V6 3123cc		
	2009-2014	VOLKSWAGEN TIGUAN	2.0L L4 1984cc 121 CID		2009-2012	AUDI Q5	3.2L V6 3123cc		
	2012-2013	VOLKSWAGEN BEETLE	2.0L L4 1984cc 121 CID		2011-2015	AUDI TT QUATTRO	2.0L L4 1984cc 121 CID		
	2012-2013	VOLKSWAGEN JETTA	2.0L L4 1984cc 121 CID		2012-2013	VOLKSWAGEN GOLF	2.0L L4 1984cc 121 CID		
	<b>US11009</b>	2003-2005	MERCEDES-BENZ E320		3.2L V6 3199cc	<b>US11024</b>	2000-2004	MERCEDES-BENZ SLK230	2.3L L4 2295cc
		2003-2005	MERCEDES-BENZ E500		5.0L V8 4973cc	2001-2004	MERCEDES-BENZ SLK320	3.2L V6 3199cc	

WATER PUMPS



# WATER PUMP BUYERS GUIDE



USMW	Years	Application	Engine	USMW	Years	Application	Engine
<b>US11024</b>	2002-2004	<b>MERCEDES-BENZ</b> G500	5.0L V8 4966cc				
	2002-2004	<b>MERCEDES-BENZ</b> SLK32 AMG	3.2L V6 3199cc				
	2003-2011	<b>MERCEDES-BENZ</b> G55 AMG	5.5L V8 5439cc 335 CID				
	2005	<b>MERCEDES-BENZ</b> G500	5.0L V8 4973cc				
	2006-2008	<b>MERCEDES-BENZ</b> G500	5.0L V8 4966cc				
	2009-2015	<b>MERCEDES-BENZ</b> G550	5.5L V8 5461cc				
<b>US11034</b>	1992-1994	<b>VOLKSWAGEN</b> CORRADO	2.8L V6 2792cc				
	1993-1994	<b>VOLKSWAGEN</b> PASSAT	2.8L V6 2792cc				
	1994	<b>VOLKSWAGEN</b> JETTA	2.8L V6 2792cc				
	1995	<b>VOLKSWAGEN</b> EUROVAN	2.5L L5 2459cc 150 CID				
	1996-1999	<b>VOLKSWAGEN</b> JETTA	2.8L V6 2792cc				
	1996-2002	<b>VOLKSWAGEN</b> GOLF	2.8L V6 2792cc				
	1997	<b>VOLKSWAGEN</b> EUROVAN	2.8L V6 2792cc				
	1999-2000	<b>VOLKSWAGEN</b> EUROVAN	2.8L V6 2792cc				
	1999-2005	<b>VOLKSWAGEN</b> BEETLE	1.8L L4 1781cc				







# WATER PUMP CROSS REFERENCE



Chrysler (cont'd.)		Chrysler (cont'd.)		Chrysler (cont'd.)	
5302 1018AD	US7160	J813 4321	US3404	MD997623	US7124
5302 1074AB	US7169	JR77 5045	US1107	MD997634	US7121
5302 1074AC	US7169	JR77 5046	US3403	MD997643	US7129
5302 1074AE	US7169	JR77 5047	US3413	MD997686	US8922
5302 1074AF	US7169	JR77 5049	US5006	MN187244	US7156
5302 1187AA	US7163	JR77 5050	US3401	R429 3898	US7110
5302 1380AG	US7168	JR77 5053	US3410	R462 1172	US7127
5302 1380AK	US7168	JR77 5056	US3409	R462 6215	US3412
5302 1380AL	US7168	JR77 5122	US3412	R462 6682	US7139
5302 1380AM	US7168	M04667660	US7150	R479 8497	US7122
5302 1844AA	US7169	MD001300	US1012	R500 3665AA	US7145
5302 2058AA	US7163	MD008431	US7104	RL02 2340AC	US8971
5302 2095AD	US8979	MD009000	US7105	RL18 4498AI	US8981
5302 2095AE	US8979	MD021450	US1124	RL184498AI	US8981
5302 2095AF	US8979	MD025190	US7111	T1464552	US3411
5302 2189AA	US7163	MD030751	US7106		
5302 2189AB	US7163	MD030863	US7115		
5302 2189AC	US7163	MD034152	US7108	<b>Cummins</b>	
5302 2189AD	US7163	MD179030	US7135	6821 0961AA	US99
5302 2189AG	US7163	MD300799	US7135	2881804	US6222
5302 2189AH	US7163	MD306414	US7135	3003749	US7145HN
5302 2192AE	US6341	MD309756	US7135	3286275	US7145HN
5302 2192AF	US6341	MD365087	US9360	3286277	US7145HN
5302 2192AI	US6341	MD971538	US9359	3800984	US6222
5302 2192AJ	US6341	MD971582	US7148	3802004	US7145HN
5302 2192AK	US6341	MD972001	US7114	3802358	US7145HN
5302 2340AC	US8971	MD972002	US7117	3802970	US7145HN
5302 2340AF	US8115	MD972003	US8922	3913432	US7145HN
6800 3402AA	US6222	MD972004	US7121	4309429	US99
6800 3402AB	US6222	MD972005	US7121	4891252	US6222
6804 5797AA	US7163	MD972050	US7129		
6804 6026AA	US6038	MD972051	US7148	<b>Daihatsu</b>	
6805 8321AA	US9379	MD972052	US7114	16100-87182-000	US9237
6807 9412AB	US6699	MD972053	US9212	16100-87183-000	US8908
6807 9412AC	US6699	MD972440	US9168	16100-87790-000	US9238
6807 9412AD	US6699	MD972897	US9168		
6808 7367AA	US6155	MD972934	US9310	<b>Fiat</b>	
6808 7367AB	US6155	MD973025	US7114	4892 713AB	US8136
6811 1624AB	US8114	MD973940	US9389	4892 713AC	US8136
6811 1624AD	US8114	MD974649	US7152	4893 386AA	US8136
6811 1624AE	US8114	MD974719	US7121	6829 1913AA	US8136
6821 1202AB	US8161	MD976464	US7115	4129810	US9203
6829 1856AA	US8136	MD976943	US7108	4129812	US9203
6831 1108AA	US8160	MD977705	US9399	4331825	US9003
6831 1109AB	US8151	MD978552	US9399	4336009	US8944
6831 3815AA	US8136	MD978743	US7152	4429226	US9085
6834 6915AA	US8115	MD978764	US6228	5882684	US9203
6834 6916AA	US8115	MD979171	US7152	5882689	US9003
6838 2489AA	US7136	MD979395	US7152	5882691	US8944
6838 2490AA	US7150	MD980000	US7152	5890406	US8944
6838 2491AA	US7165	MD997076	US9415	5936404	US9084
6838 2492AA	US7164	MD997077	US6149	5936406	US9084
6838 2493AA	US7160	MD997078	US7121	5960469	US9084
6838 2494AA	US7168	MD997079	US7115	5980756	US9084
6841 4058AB	US99	MD997081	US7105	5983960	US9084
7124 4450	US1010	MD997084	US7108	7671808	US9085
7522 1515	US1010	MD997150	US7114	7671810	US9085
8120 131	US1021	MD997158	US7118	7784974	US9084
8125 131	US3401	MD997178	US7117	46400058	US8948
8125 501	US1077	MD997244	US7117	46444355	US8948
8127 974	US3400	MD997403	US7120	46526243	US8945
8129 459	US1077	MD997404	US7120	46805736	US8945
8130 749	US3403	MD997417	US7121	55184080	US8945
8132 274	US1107	MD997418	US7124	71716878	US8948
8133 033	US3403	MD997421	US7124		
8277 5049	US5006	MD997464	US9212	<b>Ford</b>	
8350 2957	US3414	MD997485	US9212	1E04-15-010	US8934
1752422	US919	MD997515	US7131	1F1Z 8501-AA	US4094
2421375	US919	MD997609	US7108	1L2Z 8501-BA	US8920
2448315	US919	MD997614	US7106	1L2Z 8501-BB	US8920
2485385	US919	MD997615	US7108	1L3Z 8501-AB	US4125
3004762	US919	MD997616	US7121	1L3Z 8501-BA	US4121
3004991	US919	MD997619	US7115	1S7Z 8501-A	US4126
J323 4427	US3401	MD997620	US7118	1S7Z 8501-AK	US4126
J813 4320	US3403	MD997622	US7114	1S7Z 8501-D	US4126
			US7120	1S7Z 8501-K	US4126
			US7108	1U2Z 8V501-CA	US4096
			US7131	2C3Z 8V501-BA	US4114
			US9168	2R8Z 8501-AE	US4129



# WATER PUMP CROSS REFERENCE



**WATER PUMPS**

Ford (cont'd.)		Ford (cont'd.)		Ford (cont'd.)	
2S7Z 8501-BG	US4094	BE8Z 8501-B	US9449	E9TZ 8501-B	US4018
2W9Z 8501-BB	US4124	BK3Z 8501-B	US8162	E43Z 8501-B	US9067
3C3Z 8501	US61	BL3Z 8501-A	US8916	E45Y 8501-A	US9154
3C3Z 8501-A	US61	BL3Z 8501-C	US8916	E69Z 8501-A	US4039
3F2Z 8501-BB	US4102	BR3Z 8501-C	US8963	E92Z 8501-A	US4053
3L3Z 8501-CA	US8920	BR3Z 8501-G	US6654	E93Z 8501-A	US4022
3L3Z 8501-DB	US4105	BR3Z 8501-H	US8963	EJ7Z 8501-A	US8117
3R3Z 8501-A	US4103	BR3Z 8501-J	US8116	EJ7Z 8501-C	US8117
3R3Z 8501-BB	US4103	BR3Z 8501-K	US8916	EJ7Z 8501-D	US8975
4C3Z 8501-ABRM	US67	BR3Z 8501-N	US8916	EJ7Z 8501-F	US8117
4C3Z 8501-AC	US67	BR3Z 8501-P	US8116	EJ7Z 8501-G	US8975
4C3Z 8501-B	US4109	C2AZ 8501-A	US723	ER3Z 8501-C	US8916
4G7Z 8501-AA	US8125	C2AZ 8501-B	US723	EU2Z 8501-B	US4091
4S4Z 8501-AA	US4126	C4AZ 8501-A	US723	EU2Z 8501-B	US4091-2
4S4Z 8501-D	US4126	C4AZ 8501-B	US723	EU2Z 8501-D	US9489
5F1Z 8501-A	US4094	C5AZ 8501-B	US819	EU2Z 8501-D	US9489-2
5F2Z 8501-A	US4102	C5AZ 8501-K	US819	F0TZ 8501-E	US4044
5F9Z 8501-A	US6186	C5OZ 8501-A	US819	F0TZ 8501-G	US4060
5F9Z 8501-BB	US6186	CM5Z 8501-A	US8146	F0ZZ 8501-A	US4038
5L2Z 8501-A	US8920	D00Z 8501-C	US953	F1CZ 8501-A	US4069
5L3Z 8501-A	US4105	D1FZ 8501-A	US964	F1SZ 8501-A	US4057
5L8Z 8501-A	US4132	D3RY 8501-A	US964	F1SZ 8501-B	US4050
5L8Z 8501-AA	US4132	D3UZ 8501-A	US1028	F1TZ 8501-A	US1114
5M6Z 8C419-A	US11002	D4DZ 8501-A	US1044	F1VY 8501-A	US4066
5M8Z 8501-A	US9489	D4TZ 8501-H	US1075	F2TZ 8501-A	US4077
5M8Z 8501-B	US9489	D4TZ 8501-K	US1083	F2UZ 8501-A	US4079
5R3Z 8501-A	US4119	D4UZ 8501-A	US1052	F2UZ 8501-C	US4081
5R8Z 8501-A	US4129	D5DZ 8501-A	US960	F0ZZ 8501-B	US4059
5R8Z 8501-B	US4129	D5ZZ 8501-A	US1070	F3DZ 8501-A	US4082
5W7Z 8501-AA	US4128	D6AZ 8501-A	US932	F3LY 8501-A	US4113
6L2Z 8501-A	US4108	D6ZZ 8501-B	US953	F3TZ 8501-C	US4044
6M6Z 8C419-A	US11002	D8BZ 8501-A	US4002	F3TZ 8501-E	US4079
6U7Z 8501-A	US4102	D8FZ 8501-A	US4005	F3XZ 8501-BA	US9074
6U7Z 8501-B	US4102	D8RZ 8501-A	US4003	F3ZZ 8501-B	US4038
7C3Z 8B552-A	US11006	D8TZ 8501-B	US1114	F4AZ 8501-A	US4066
7L3Z 8501-A	US6144	D8ZZ 8501-A	US1047	F4BZ 8501-B	US4049
7R3Z 8501-A	US8125	D9HZ 8501-A	US4037	F4CZ 8501-A	US4069
7R3Z 8501-BB	US8125	D9HZ 8501-B	US4037	F4DZ 8501-A	US4089
7S7Z 8501-A	US9449	D7TZ 8501-A	US1042	F4DZ 8501-B	US4034
7S7Z 8501-C	US9449	DG1Z 8501-A	US8910	F4SZ 8501-A	US4090
7S7Z 8501-G	US9449	DG1Z 8501-C	US8910	F4TZ 8501-ARM	US4096
7S7Z 8501-L	US9449	DS7Z 8501-E	US8107	F4TZ 8501-B	US4086
7T4Z 8501-B	US6023	E0ZZ 8501-A	US4024	F4ZZ 8501-B	US4087
7T4Z 8501-C	US6023	E1AZ 8501-A	US4014	F5DZ 8501-A	US4094
7T4Z 8501-D	US6023	E1AZ 8501-A	US4014H	F5DZ 8501-CL	US4098
8C3Z 8501-B	US76	E2DZ 8501-A	US4016	F5OY 8501-A	US4097
8M6Z 18D473-A	US11007	E2HZ 8501-B	US4037	F5RZ 8501-B	US4088
9L8Z 8501-A	US6250	E2TZ 8501-A	US4030N	F5TZ 8501-A	US4099
9L8Z 8501-C	US6250	E3TZ 8501-F	US4023	F5TZ 8501-BRM	US4096
9M6Z 8C419-A	US11001	E3TZ 8501-G	US4033	F5TZ 8501-C	US4060
96BX 8591-A2B	US8934	E4BZ 8501-A	US4054	F5TZ 8501H2-A	US4044
96BX 8591-AA	US8934	E4ZZ 8501-A	US4024	F6DZ 8501-A	US4098
1000398	US8934	E5HZ 8501-B	US4037	F6DZ 8501-B	US4106
1020567	US8934	E5TZ 8501-C	US1114	F6DZ 8501-FA	US4094
1089795	US8931	E5ZZ 8501-A	US4035	F6LZ 8501-AA	US4113
1109341	US8934	E6AZ 8501-B	US4014	F6PZ 8501-AA	US4069
1229571	US8931	E6AZ 8501-B	US4014H	F6TZ 8501-AA	US4114
1429037	US8934	E6DZ 8501-A	US4034	F6TZ 8501-KA	US4099
1518911	US8934	E6TZ 8501-A	US4042	F6TZ 8501-KB	US4079
AA5Z 8501-A	US6023	E6ZZ 8501-A	US4054	F6ZZ 8501-A	US4103
AA5Z 8501-C	US8910	E7FZ 8501-B	US9067	F7BZ 8501-A	US4049
AA5Z 8501-D	US6023	E7TZ 8501-A	US4044	F7CZ 8501-AB	US4107
AC3Z 8501-A	US6006	E7TZ 8501-B	US4048	F7DZ 8501-A	US4098
AL3Z 8501-A	US6006	E8AZ 8501-A	US4052	F7TZ 8501-AB	US4060
AL3Z 8501-B	US8920	E8BZ 8501-A	US4049	F7TZ 8501-AC	US4060
AR3Z 8501-A	US4119	E8DZ 8501-A	US4051	F7TZ 8501-CRM	US4114
AT4Z 8501-A	US8980	E8DZ 8501-B	US4051	F7UZ 8501-CA	US8920
AT4Z 8501-B	US8910	E8FZ 8501-A	US4040	F7ZZ 8501-AA	US4103
AT4Z 8501-CA	US8910	E9BZ 8501-A	US4049	F8AZ 8501-AA	US4066
B5A-8501-C	US488	E9DZ 8501-B	US4056	F8DZ 8501-AA	US4094
B6A-8501-B	US488	E9JY 8501-B	US4068	F8OZ 8501-AA	US4097
B6A-8501-C	US488	E9PZ 8501-A	US4020	F8RZ 8501-EN	US4115
BC3Z 8501-A	US77	E9PZ 8501-C	US4083	F8RZ 8501-NE	US4115
BC3Z 8501-B	US78	E9PZ 8501-D	US4030N	F8YZ 8501-AA	US11014
BC3Z 8501-C	US78	E9SZ 8501-B	US4055	F8ZZ 8501-AA	US4103



# WATER PUMP CROSS REFERENCE



Ford (cont'd.)		Ford / International (cont'd.)		General Motors (cont'd.)	
F23Z 8501-A	US4070	8C3Z 8501-B	US76	3957982	US981
F23Z 8501-B	US4041	1812313C93	US4096	3960122	US927
F32Z 8501-A	US9259	1823669C92	US66	3986364	US898
F32Z 8501-B	US4078	1831005C92	US4114	4409162	US8914
F33Z 8501-A	US4041	1831676C91	US66	4640058	US8946
F42Z 8501-A	US9318	1831676C92	US66	5740079	US5008
F57Z 8501-A	US4093	1845002C91	US85	05740079	US5008
F59Z 8501-A	US4095	BC3Z 8501-A	US77	05743241	US5062
F59Z 8501-B	US4039	D9HZ 8501-A	US4037	05743939	US5049
F63Z 8501-AA	US4091	D9HZ 8501-B	US4037	05744474	US5074
F65Z 8501-BA	US8920	E2HZ 8501-B	US4037	5744662	US5074
F68Z 8501-A	US4102	E4TZ 8501-C	US4018	05744662	US5074
F77Z 8501-AD	US4108	E5HZ 8501-B	US4037	05744938	US5074
F81Z 8501-ARM	US4114	E7HN 8A513 AB	US4062	6258119	US896
F81Z 8501-CRM	US4114	E8HZ 8501-B	US4062	6258551	US984
F81Z 8501-DA	US4109	E9TZ 8501-B	US4018	7490004	US5064
F81Z 8501-FA	US4114	F5TZ 8501-B	US4096	7490007	US5072
F85Z 8501-AA	US4105	F5TZ 8501-C	US4096	9772372	US850
F87Z 8501-BA	US4093	F6TZ 8501-AA	US4114	9784281	US850
F87Z 8501-BB	US4093	F7TZ 8501-BRM	US4114	9788606	US850
F87Z 8501-CA	US4101	F7TZ 8501-C	US4114	9793130	US850
F87Z 8501-DA	US4095	F81Z 8501-A	US4114	10013800	US5000
FOAZ 8501-A	US4052	F81Z 8501-ABRM	US67	10032022	US5022
FOCZ 8501-A	US4065	F81Z 8501-ARM	US4114	10046305	US5030
FODZ 8501-A	US4061	F81Z 8501-B	US4114	10048917	US1121
FOPZ 8501-A	US4020	F81Z 8501-CRM	US4114	10048919	US5016
FOTZ 8501-D	US4060	F81Z 8501F-A	US4114	10048949	US5033
FOTZ 8501-F	US4048	YC3Z 8501-AARM	US66	10048950	US5035
FT4Z 8501-C	US8141P	YC3Z 8501-CA	US66	10065240	US5007
FT4Z 8501-C	US8141P-T	<b>General Motors</b>		10074182	US5084
FT4Z 8501-D	US8141	2402 903	US1053	10077051	US5004
FT4Z 8501-D	US8141-T	230337	US926	10077059	US5049
HC3Z 8501-A	US8157	230609	US926	10089654	US5032
HL3Z 8501-A	US8149	230900	US926	10089659	US5006
XC2Z 8501-BA	US8920	231462	US1120	10120938	US1107
XF1Z 8501-AA	US4094	231886	US1100	10120943	US5035
XF2Z 8501-AA	US4102	231933	US926	10120944	US5037
XF5Z 8501-AA	US9402	357261	US895	10120945	US5001
XF5Z 8501-BA	US9402	358937	US927	10140667	US5078
XL3Z 8501-AA	US8920	359913	US1069	10159526	US5000
XL3Z 8501-BA	US4121	361053	US1088	10159599	US5056
XL5Z 8501-AA	US4095	361054	US1107	10174846	US5051
XL5Z 8501-AC	US4095	361055	US1110	10174979	US5020
XL5Z 8501-AD	US4095	400269	US926	10181235	US5040
XL5Z 8501-CA	US4093	404847	US926	10181327	US5040
XR3Z 8501-AA	US4119	458486	US981	12300305	US975
XS2Z 8501-BC	US4091	474028	US1109	12307798	US896
XS2Z 8501-CC	US4091	474029	US1121	12307815	US898
XS2Z 8501-CD	US4091	474055	US5030	12309445	US975
XS2Z 8501-CF	US4091	474056	US1137	12309978	US5003
XS2Z 8501-EA	US4091	488377	US975	12334884	US5028
XS2Z 8501-EA	US4091-2	556283	US1120	12336298	US5050
XS6E 6659	US8931	1241680	US1061	12337519	US1120
XS6E 8501AD	US8931	1247080	US1045	12337663	US5012
XU2Z 8501-EA	US4018	1260709	US1018	12337664	US5014
XW4Z 8501-BA	US4118	1334037	US1061	12363169	US5032
XW4Z 8501-CD	US4118	1334135	US8933	12369484	US5023
YC2Z 8501-BA	US8920	1334139	US8925	12369487	US5049
YC3Z 8501-AA	US4109	1363989	US855	12369537	US5081
YC3Z 8501-AB	US4109	1396317	US855	12455105	US5085
YF3Z 8501-A	US4097	1396346	US855	12456112	US5081
YF3Z 8501-AB	US4097	1396715	US855	12456113	US64
YR3Z 8501-AB	US4119	1396876	US855	12456113	US64-T
YS4Z 8501-AA	US4123	3634580	US5010	12456231	US5086
YSG6 8501-A2C	US4104	3634838	US5010	12456326	US5038
YW7Z 8501-AA	US4113	3856284	US981	12458115	US5085
YW7Z 8501-BB	US4128	3861920	US896	12458326	US5038
<b>Ford / International</b>		3876172	US896	12458920	US5040
3C3Z 8501-A	US61	3876173	US981	12458922	US5051
3C3Z 8501-ABRM	US61	3877021	US927	12458934	US5081
3C3Z 8501-BA	US61	3929218	US896	12458935	US64
4C3Z 8501-AB	US67	3929233	US898	12458935	US64-T
4C3Z 8501-ABRM	US67	3932422	US896	12462265	US5032
4C4Z 8501-AARM	US85	3937996	US898	12481997	US5000
5C4Z 8501-AA	US85	3957981	US898	12482000	US5041





# WATER PUMP CROSS REFERENCE



General Motors (cont'd.)		General Motors (cont'd.)		General Motors (cont'd.)	
12482690	US5035	12671394	US8918	24571389	US5043
12482694	US5037	12671752	US8123	24576952	US5097
12482696	US5001	12672035	US8148	24577255	US5076
12482903	US5075	12673412	US8147	25186130	US8999
12482919	US5050	12674640	US8918	25188341	US8984
12484890	US1002	12676472	US8123	25189098	US8999
12487361	US5072	12678128	US8123	25191164	US8999
12491038	US5040	12679360	US8153	25191167	US8984
12507232	US5067	12680257	US310	25192709	US6662
12508606	US5017	12681171	US8147	25195119	US6184
12509653	US5063	12681174	US8147	25527536	US1018
12512740	US5078	12681259	US8123	52273124	US5017
12514269	US5008	12681417	US6009	55352002	US5079
12514574	US5062	12681417	US6009-T	55352570	US5092
12517379	US5017	12683010	US8918	55486342	US6662
12518277	US5068	12683012	US8918	55486344	US6662
12518443	US5032	12683013	US8123	55488983	US8159
12520263	US5078	12685257	US8918	55492937	US8155
12520914	US5070	12685731	US8123	55561623	US6662
12521037	US5038	12685733	US8918	55570270	US8152
12522031	US5049	12687615	US8918	55579016	US6662
12522033	US1121	12687616	US8123	55580028	US8152
12522034	US5051	12688645	US8123	55582273	US8155
12522036	US5073	12692045	US8918	88893906	US5089
12523499	US5066	14002440	US5084	88893907	US5090
12523502	US5069	14058915	US5019	88894005	US5049
12523505	US5030	14058915	US5019H	88894035	US5086
12524131	US1121	14063641	US5015	88894036	US5074
12525123	US5038	14071866	US5004	88894044	US5062
12527740	US5069	14079351	US5004	88894290	US64
12527741	US5068	14085847	US1121	88894290	US64-T
12527759	US5038	14085852	US1002	88894341	US1121
12529192	US5078	14089011	US5020	88894344	US5072
12529305	US1121	14101304	US5001	88972167	US5099
12529993	US5072	15633465	US5008	88972167	US9376
12530176	US5074	15633466	US5062	88972819	US9405
12532528	US5077	16444355	US8946	88973887	US9376
12532529	US5049	19168601	US5038	88974712	US9405
12532531	US5049	19168601	US5038H	89017269	US5033
12534417	US5062	19168602	US5019	89017311	US5033
12534418	US5008	19168602	US5019H	89017439	US64
12534772	US5074	19168606	US1002	89017439	US64-T
12537495	US5050	19168609	US5086	89017456	US5081
12551474	US5078	19168610	US5074	89017457	US65N
12581517	US9470	19168611	US5062	89017457	US65N-T
12583033	US8956	19168612	US5054	89017467	US5072
12585226	US5092	19168613	US5085	89017583	US6145
12591894	US5092	19168888	US63	89017592	US65
12595614	US8955	19179031	US6145	89017592	US65-T
12600767	US6009	19180610	US79	89017593	US65
12600767	US6009-T	19185381	US9414	89017593	US65-T
12618472	US8932	19185491	US6232	89017693	US5089
12620226	US5097	19201601	US5049	89017748	US5077
12622036	US8142	19205246	US6232	89017757	US6020
12622036	US8142-T	19207665	US6689	89017771	US5089
12624936	US5092	19208815	US6009	89017773	US5090
12630084	US5092	19208815	US6009-T	89017900	US5072
12635743	US9470	19209288	US5075	89018052	US65N
12637105	US72	19210509	US5072	89018052	US65N-T
12637479	US8932	19317040	US6218	89018053	US65
12638455	US8158	21006933	US5054	89018053	US65-T
12645126	US8154	21007155	US5054	89018165	US6154
12645159	US8158	21007225	US5054	89018166	US64
12645176	US8932	21007288	US5054	89018166	US64-T
12653661	US8102	21007655	US5054	89018214	US5075
12656810	US8918	21015340	US5054	89060462	US5075
12656811	US8123	22514839	US5012	89060479	US6020
12657499	US8932	22519584	US5014	89060527	US5077
12663909	US8102	23500133	US5008	90220568	US5036
12663910	US8102	23500138	US5062	90325660	US8917
12667383	US8147	24405895	US6184	90392900	US5045
12667384	US8147	24409355	US8925	90392901	US5057
12667385	US8147	24439798	US5092	90392902	US5036
12667387	US8147	24467301	US5092	90392908	US5017
12670051	US8918	24570464	US5043	90543277	US5079

WATER PUMPS



# WATER PUMP CROSS REFERENCE



General Motors (cont'd.)		Honda (cont'd.)		Hyundai	
90543935	US8933	19200-P1R-003	US9253	25100-2B000	US6247
91160212	US8914	19200-P2A-A01	US9352	25100-2B700	US6247
91172178	US5048	19200-P5A-004	US9354	25100-2E000	US8106
91173189	US5058	19200-P5G-004	US9348	25100-2E005	US8106
91173496	US5048	19200-P08-004	US9250	25100-2E020	US8106
91174230	US9374	19200-P8A-A01	US9383	25100-2G000	US6220
91174494	US9342	19200-P8A-A02	US9383	25100-2G100	US6220
91175666	US5058	19200-P8A-A03	US9383	25100-2G200	US6220
91176170	US9385	19200-P10-A02	US9130	25100-2G400	US6220
91176915	US5058	19200-P13-003	US9273	25100-2G500	US8982
91177756	US9342	19200-P14-A01	US9251	25100-2G510	US8982
91177757	US9385	19200-P30-003	US9321	25100-2G600	US6220
92064250	US8925	19200-P72-003	US9289	25100-2G650	US6220
92149009	US8932	19200-P72-013	US9468	25100-2GTA0	US8163
93170697	US5079	19200-P75-003	US9349	25100-2GTC0	US8163
93231147	US5017	19200-PA6-030	US9035	25100-3C100	US6048
93385844	US8938	19200-PB2-010	US9029	25100-3C120	US6048
94013802	US8917	19200-PB2-405	US9029	25100-3C130	US6048
94022627	US1046	19200-PC1-000	US9035	25100-3C131	US6048
94109591	US5031	19200-PD2-660	US9056	25100-3E001	US6215
94118501	US5027	19200-PD6-000	US9056	25100-02500	US8935
94202477	US1127	19200-PE0-010	US9069	25100-02501	US8935
94239153	US5013	19200-PE0-415	US9069	25100-02502	US8935
94239649	US9132	19200-PE0-515	US9069	25100-02555	US8935
94360200	US9220	19200-PE8-405	US9043N	25100-02577	US8939
94391670	US73	19200-PE8-600	US9043N	25100-02588	US8939
94840612	US9057	19200-PH1-000	US9083	25100-12500	US8935
94844775	US9076	19200-PH7-003	US9097	25100-12501	US8935
94847609	US9057	19200-PLM-A01	US9419	25100-21000	US7115
94854103	US9272	19200-PNA-003	US9434	25100-22650	US7115
94856254	US9271	19200-PNL-E01	US9434	25100-22900	US9364
94858649	US9376	19200-PR4-013	US9224	25100-23001	US9353
95711070	US8932	19200-PR7-305	US9219	25100-23002	US9353
96054298	US5029	19200-PR7-A01	US9219	25100-23003	US9353
96059659	US5048	19200-PR7-A02	US9219	25100-23010	US9353
96062832	US5048	19200-PR7-A03	US9219	25100-23021	US8972
96182871	US8917	19200-PRB-A01	US6703	25100-23022	US8972
96351971	US8917	19200-PV1-A01	US9253	25100-23513	US9353
96352649	US8917	19200-PV3-003	US9253	25100-23522	US8972
96352650	US6046	19200-PY3-010	US9218	25100-23530	US8972
96352652	US8917	19200-PY3-A00	US9288	25100-24030	US7115
96416294	US8984	19200-PZA-013	US6216	25100-25002	US6220
96518977	US8928	19200-R1A-A01	US6693	25100-26900	US9364
96872700	US8917	19200-R5A-A01	US8137	25100-26902	US9364
96872702	US6046	19200-R40-A01	US6233	25100-32515	US7118
96930074	US6046	19200-R70-A11	US9470	25100-33012	US7131
96990997	US8917	19200-RAA-A01	US9461	25100-33132	US9212
97031472	US9221	19200-RAD-003	US9461	25100-35050	US7121
97216136	US63	19200-RB0-003	US6350	25100-37202	US9462
97372515	US72	19200-RBB-013	US9461	25100-38200	US9399
98031233	US72	19200-RBC-013	US9495	25100-39010	US9463
98098889	US72	19200-RBJ-003	US8983	25100-39012	US9463
<b>Honda</b>		19200-RCA-A01	US9470	25100-42540	US8922
8-97081-623-0	US9133	19200-RDF-A01	US8103	25110-2G000	US6220
8-97125-975-0	US9278	19200-RDM-A01	US9470	25110-2G400	US6220
8-97167-554-0	US9365	19200-RDM-A02	US9470	25110-2G500	US8982
06192-R1A-305	US6056	19200-RDV-J01	US9470	25110-2G510	US6220
06194-RNA-305	US6056	19200-RFE-003	US9461	25110-25002	US6220
19110-634-375	US9033	19200-RME-A01	US6018	<b>International / Navistar</b>	
19110-634-405	US9033	19200-RMX-003	US6216	4C4Z-8501-AARM	US85
19110-657-335	US9034	19200-RNA-A01	US6056	5C4Z-8501-AA	US85
19110-657-405	US9034	19200-RNA-A02	US6056	270918C93	US1099
19110-671-335	US9034	19200-RW0-003	US8144	463365C91	US1099
19110-673-335	US9034	19200-RWC-A01	US6223	861236R92	US1099
19110-689-335	US9034	19200-RX0-A01	US6213	1803276C95	US3705
19110-689-405	US9034	19210-PC1-515	US9035	1805952C91	US3705
19200-5A2-A01	US8103	19210-PCX-003	US9403	1809374	US3705
19200-5J0-A01	US8138	19210-PD2-515	US9056	1809374C91	US3705
19200-5LA-A01	US8118	19210-PD6-505	US9056	1812313C93	US4096
19200-5R0-003	US8119	19210-PD6-515	US9056	1845002C91	US85
19200-59B-003	US8145	19210-PG6-305	US9115	F5TZ 8501-B	US4096
19200-657-010	US9034	19210-PH1-515	US9083	<b>Isuzu</b>	
19200-P0A-003	US9209	19210-PH3-305	US9131	5-86202-375-0	US9209
19200-P0G-A01	US9097	19210-PHM-010	US9494	8-10120-943-0	US5035
19200-P01-004	US9130	19210-PK2-305	US9129	8-12462-265-0	US5032



# WATER PUMP CROSS REFERENCE



WATER PUMPS

Isuzu (cont'd.)		Jaguar (cont'd.)		Mazda (cont'd.)	
8-12482-690-0	US5035	NBB2200DA	US9280	8AF3-15-010B	US9102
8-12532-528-0	US5077	XR813290	US4118	8AF4-15-010B	US9102
8-12620-226-0	US5097	<b>Kia</b>		8AFB-15-010A	US9208
8-24576-952-0	US5097	0FE1H-15-010H	US4053	8AFC-15-010A	US9208
8-88894-290-0	US64	0K24A-15-010	US9305	8AFC-15-010B	US9208
8-88894-290-0	US64-T	0K30E-15-010	US9473	8AFD-15-010	US9208
8-89017-439-0	US64	0K247-15-010A	US9393	8AG6-15-010	US9067
8-89017-439-0	US64-T	0K247-15-010B	US9393	8AG6-15-010A	US9067
8-89018-166-0	US64	0K930-15-010A	US4049	8AG7-15-010	US9060
8-89018-166-0	US64-T	21355-3C510	US6048	8AG7-15-010A	US9060
8-89060-527-0	US5077	25100-2B000	US6247	8AG9-15-010	US4078
8-90466-343-0	US9375	25100-2B700	US6247	8AH3-15-010A	US9166
8-92064-250-0	US9375	25100-2X401	US9473	8AH3-15-010B	US9166
8-92065-969-0	US9375	25100-2Y000	US9393	8AH6-15-010	US9225
8-93284-724-0	US9375	25100-2Y010	US9393	8AH6-15-010B	US9225
8-94109-591-1	US5031	25100-2Y011	US9393	8AH7-15-010A	US9260
8-94118-501-0	US5027	25100-3C100	US6048	8AL1-15-010A	US9167
8-94120-768-1	US9132	25100-3C120	US6048	8AL1-15-010C	US9167
8-94131-330-1	US9106	25100-3C121	US6048	8AL4-15-010	US9394
8-94146-326-0	US9105	25100-3C130	US6048	8AL4-15-010A	US9394
8-94146-326-1	US9105	25100-3C131	US6048	8AS4-15-010A	US9020
8-94174-226-2	US9133	25100-3C160	US6048	8BU1-15-010	US7120
8-94202-477-1	US1127	25100-3C170	US6048	8BU1-15-010RMO	US7120
8-94224-894-0	US1127	25100-3E000	US9462	0305-15-010D	US9300
8-94239-649-0	US9132	25100-3E001	US6215	0305-15-010E	US9300
8-94332-636-0	US9134	25100-3X000	US9450	0305-99-151	US9300
8-94332-637-1	US9105	25100-23021	US8972	0324-15-010D	US9020
8-94332-638-2	US9133	25100-23022	US8972	0324-15-010E	US9020
8-94376-837-0	US9132	25100-25002	US6220	0381-15-010A	US1042
8-94376-845-0	US9106	25100-26902	US9364	0381-15-010B	US1042
8-94376-846-0	US9105	25100-37102	US9462	0381-99-151	US1042
8-94376-847-0	US9133	25100-37201	US9462	0381-99-151A	US1042
8-94376-859-1	US9132	25100-37202	US9462	1757-23-925B	US9053
8-94376-866-0	US5031	25100-38002	US9399	1757-99-151	US9053
8-94376-868-0	US9160	25100-38200	US9399	3648-15-130B	US9053
8-94391-670-5	US73	25100-39010	US9463	8872-15-010B	US9053
8-94437-048-1	US9160	25100-39012	US9463	8872-15-010D	US9053
8-97010-201-0	US5027	25100-39800	US9448	8872-15-0101	US9053
8-97012-298-0	US1127	25100-39802	US9448	AJ03-15-010B	US4091
8-97021-773-0	US9105	<b>Land Rover</b>		AJ03-15-010F	US4132
8-97021-774-0	US9133	138 6525	US6251	AJ03-15-010G	US4132
8-97031-472-0	US9221	457 5902	US4124	AJ57-15-010	US9489
8-97031-473-0	US9220	LR0 10801	US8120	AJ57-15-010A	US9489
8-97061-280-0	US9278	LR0 33993	US8120	AJ57-15-010B	US9489
8-97081-623-0	US9133	LR0 55239	US8120	AJTM-15-010	US9489
8-97081-623-1	US9133	LR0 73711	US8120	AJY1-15-010	US4091
8-97081-624-0	US9105	LR0 97165	US8120	B6BF-15-010F	US9305
8-97081-624-1	US9105	PEB 102240L	US9496	B6BF-15-010RMF	US9305
8-97125-975-0	US9278	RTC 6339	US9368	B630-15-010RMD	US4049
8-97167-554-0	US9365	ST 1693	US9369	B660-15-010RME	US4068
8-97602-776-0	US73	ST 4378	US9369	CY02-15-010	US6023
<b>Jaguar</b>		STC 483	US9368	CY02-15-010A	US6023
AJ84817	US4129	STC 1693	US9369	CY02-15-010C	US6023
AJ88417	US4124	STC 4378	US9369	CY02-15-010D	US6023
AJ88912	US4124	<b>Mazda</b>		E301-15-010	US9050
AJ811935	US4118	1F00-15-010	US4093	E301-15-010A	US9050
AJ813157	US4118	1F20-15-010	US4126	E301-15-010B	US9050
C2C32677	US4129	1F22-15-010	US4108	E301-15-010C	US9050
C2C38862	US4129	1F70-15-010	US4126	F801-15-010C	US9060
C2S26232	US4118	1F70-15-010	US4126	F801-15-010D	US9060
C2S43292	US6657	1F70-15-100	US4126	FE79-15-010B	US9060
C38405	US9165	1F82-15-010	US4108	FE79-15-010C	US9060
EAC3033	US9165	8A81-15-010	US9050	FE79-15-010E	US9111
EAC7242	US9163	8AB4-15-010A	US4049	FE79-15-010RMJ	US9060
EAC9213	US9163	8AB5-15-010A	US4068	FEMJ-15-100RMO	US4053
EBC4437	US9163	8AB7-15-010	US4049	FP01-15-010F	US4078
EBC8550	US9163	8AB8-15-010	US4068	FP01-15-010G	US4078
EBC10566	US9356	8ABB-15-010A	US9305	FS01-15-010F	US4078
EBC10967	US9356	8ABC-15-010	US9371	FS01-15-010RMF	US4078
JLM361	US9165	8ABE-15-010	US9371	GY01-15-010B	US4091
JLM398	US9211	8ABT-15-010A	US9050	JE96-15-010B	US9394
JLM9696	US9211	8AD2-15-010A	US4049	JE96-15-010RM	US9394
JLM9697	US9165	8AF2-15-010B	US9102	JE96-15-010RMB	US9166
JLM10648	US9165	8AF2-15-010C	US9102	JF03-15-010RME	US9166
JLM10819	US9165	8AF3-15-010A	US9102	KJ01-15-010H	US9328



Mazda (cont'd.)	Mercedes-Benz (cont'd.)	Nissan (cont'd.)
KL01-15-010RMB	US9328 602 200 04 20	US9228 21010-31U25
KL47-15-010C	US9318 605 200 08 20	US9228 21010-31U26
KL47-15-010RMC	US9318 611 200 05 01	US6008 21010-31U27
L3G2-15-100	US4126 611 200 11 01	US6008 21010-31U28
L3G2-15-100A	US4126 611 220 01 10	US6008 21010-31U29
L327-15-100	US4126 613 200 09 01	US6152 21010-31U85
L327-15-100A	US4126 642 200 07 01	US6155 21010-31W26
LF01-15-100	US4126 642 200 10 01	US6349 21010-40F25
LF52-15-100	US4126 642 200 13 01	US6155 21010-50A25
LF52-15-100A	US4126 642 200 17 01	US6155 21010-50A27
LF94-15-100	US6219 647 200 01 01	US6007 21010-50A89
LF94-15-100A	US6219 5103 576AA	US6008 21010-50A94
N3H1-15-100B	US6156 5103 576AB	US6008 21010-50AY8
N3H81-15-100A	US6156 5138 057AA	US6007 21010-53J05
N232-99-153A	US9053 A211 835 02 64	US11009 21010-53Y01
N232-99-153B	US9053 A611 200 11 01	US6008 21010-60U26
N304-15-010C	US9053 A642 200 13 01	US6007 21010-60UY6
PE01-15-010B	US6700	US6700 21010-77A00
PEDD-15-010	US6700	US6700 21010-77AY0
RF01-99-154	US9067	US9067 21010-80W26
RF01-99-154A	US9067	US9067 21010-80W89
YF09-15-100	US4115	US4115 21010-82W25
ZJ01-15-010B	US6295	US6295 21010-86G00
ZJ01-15-010C	US6295	US6295 21010-86G25
ZL01-15-010	US9305	US9305 21010-88R00
ZL01-15-010A	US9305	US9305 21010-88R10
ZZC4-15-010	US6250	US6250 21010-97E00
ZZJ1-15-010	US6023	US6023 21010-13200
ZZL0-15-010A	US4060	US4060 21010-13201
ZZM0-15-010	US4054	US4054 21010-13202
ZZM3-15-010	US4093	US4093 21010-13205
ZZM5-15-010	US4060	US4060 21010-13206
ZZM5-15-010A	US4060	US4060 21010-13225
ZZM7-15-010	US4095	US4095 21010-13226
ZZMA-15-010	US4039	US4039 21010-21028
ZZR1-15-010	US4095	US4095 21010-21089
ZZR1-15-010A	US4095	US4095 21010-23028
ZZR1-15-010B	US4095	US4095 21010-AL525
<b>Mercedes-Benz</b>		
000 500 03 86	US11015	US11015 21010-AL526
001 835 13 64	US11024	US11024 21010-AL527
102 200 42 01	US9173	US9173 21010-AL528
102 200 62 01	US9175	US9175 21010-AR025
103 200 37 01	US9202	US9202 21010-AR725
104 200 31 01	US9222	US9222 21010-B17G2
104 200 33 01	US9313	US9313 21010-BX000
104 200 44 01	US9311	US9311 21010-D0126
104 200 47 01	US9345	US9345 21010-EA010
104 200 48 01	US9343	US9343 21010-EB30A
104 200 49 01	US9344	US9344 21010-EB300
104 200 54 01	US9344	US9344 21010-ET025
104 200 57 01	US9344	US9344 21010-F460A
104 200 58 01	US9351	US9351 21010-F461A
110 200 02 20	US9299	US9299 21010-F461B
110 200 17 20	US9172	US9172 21010-F462A
110 200 20 20	US9299	US9299 21010-F4300
111 200 04 01	US9314	US9314 21010-F4400
111 200 23 01	US9440	US9440 21010-F4600
111 200 40 01	US9314	US9314 21010-G3925
111 200 42 01	US6229	US6229 21010-G3926
112 200 14 01	US9380	US9380 21010-G3928
112 200 15 01	US9379	US9379 21010-H7227
116 200 17 01	US9231	US9231 21010-JA10A
117 200 33 01	US9230	US9230 21010-JK00A
117 200 38 01	US9176	US9176 21010-JK00C
119 200 15 01	US9315	US9315 21010-M66Y6
119 200 21 01	US9346	US9346 21010-M6626
120 200 11 01	US9277	US9277 21010-N5829
211 835 02 64	US11009	US11009 21010-N5829
271 200 02 01	US6030	US6030 21010-N5885
272 200 04 01	US6075	US6075 21010-N8527
272 200 04 91	US6075	US6075 21010-P7586
272 200 09 01	US6142	US6142 21010-P7589
273 200 02 01	US6235	US6235 21010-U6727
275 200 01 01	US6273	US6273 21010-V5528
		US9162 21010-VV227
		US9162 92516-EA50B
		US11005





# WATER PUMP CROSS REFERENCE



Toyota (cont'd.)		Toyota (cont'd.)		Volkswagen / Audi (cont'd.)	
16100-29156	US9406	16110-19185	US9272	06F 121 011 X	US6022
16100-29156-83	US9406	16110-19205	US9271	06H 121 026 AB	US9047
16100-29157	US9406	16110-26020	US9016	06H 121 026 AB	US9047-2
16100-29157-83	US9406	16110-26020-84	US9016	06H 121 026 AF	US9047
16100-29415-83	US9405	16110-26021	US9018	06H 121 026 AF	US9047-2
16100-39316	US9017	16110-26021-84	US9018	06H 121 026 BA	US9047
16100-39317	US9017	16110-28010	US9018	06H 121 026 BA	US9047-2
16100-39317-77	US9017	16110-28010-77	US9018	06H 121 026 CF	US9047
16100-39346-83	US9141	16110-38020	US9005	06H 121 026 CF	US9047-2
16100-39435	US6143	16110-38022	US9027	06H 121 026 CQ	US9047
16100-39436	US6143	16110-38022-77	US9027	06H 121 026 CQ	US9047-2
16100-39456	US6047	16110-45070	US9180	06H 121 026 DD	US9047
16100-39465	US6232	16110-49025	US9170	06H 121 026 DD	US9047-2
16100-39466	US6232	16110-49026-77	US9170	06J 121 026 J	US9047
16100-39495	US6197	16110-49097	US9292	06J 121 026 J	US9047-2
16100-39496	US6197	16110-49115	US9256	06J 121 026 M	US9047
16100-39505	US6338	16110-49116	US9256	06J 121 026 M	US9047-2
16100-39506	US6338	16110-49125	US9292	06K 121 011 B	US8124
16100-39515	US6252	16110-49126	US9292	06K 121 011 C	US8124
16100-39545	US6599	16110-49156	US9395	7B0 121 011	US6231
16100-39555	US6336	16110-61081	US9337	7B0 121 011 A	US8951
16100-39615	US8150	16110-61081-77	US9337	7B0 121 011 B	US8981
16100-49095	US9181	16110-61180	US9155	7B0 121 011 BXRMM	US8981
16100-49655	US9040N	16110-69035	US9048	7B0 121 011 C	US6231
16100-49656-77	US9040N	16110-69036-77	US9048	7B0 121 011 D	US8951
16100-49776	US9100	16110-79026-83	US9099	7B0 121 011 E	US8981
16100-49805-83	US9100	16110-79095	US9140	7B0 121 011 F	US6231
16100-49837-83	US9256	16110-79115	US9140	7B0 121 011 G	US8981
16100-50023-83	US9257	16120-41060	US9180	07D 121 005 R	US8111
16100-59127	US9094	16120-42011	US9180	07D 121 008 A	US8111
16100-59129	US9094	16290-21011	US11013	07K 121 011 B	US6050
16100-59137	US9200	87200-33010	US11012	07K 121 011 BX	US6050
16100-59139	US9200	87200-47030	US11011	07L 121 014 F	US6702
16100-59275-83	US9257	SU003-00401	US9384	021 121 004	US9262
16100-59276	US9257	<b>Volkswagen / Audi</b>		021 121 004 A	US9262
16100-60080	US9078	1K0 965 561 G	US11017	021 121 004 AX	US9262
16100-61012	US9189	1K0 965 561 J	US11008	021 121 004 X	US9262
16100-61041	US9189	03C 121 005 B	US8996	022 121 011	US9471
16100-61070	US9493	03C 121 005 C	US8996	022 121 011 A	US6221
16100-61080	US9493	03C 121 005 D	US8996	022 121 011 B	US6221
16100-61130	US9189	03C 121 005 N	US8977	022 121 011 V	US9471
16100-69085	US9059	03C 121 008 J	US8108	022 121 011 X	US9471
16100-69255	US9155	3D0 965 561 D	US11004	025 121 010 AX	US9061
16100-69275	US9059	03L 121 011 B	US6034	025 121 010 CX	US9150
16100-69325	US9269	03L 121 011 BX	US6034	026 121 005 C	US9065
16100-69385	US9320	03L 121 011 G	US6034	026 121 005 G	US9065
16100-69398-83	US9324	03L 121 011 GX	US6034	026 121 005 H	US9065
16100-69455-83	US9258	03L 121 011 H	US8108	026 121 005 JX	US9065
16100-69465-83	US9142	03L 121 011 HX	US8108	026 121 005 L	US9401
16100-69475-83	US9145	03L 121 011 P	US8108	026 121 010 DX	US9066
16100-69485-83	US9291	06A 121 011 F	US9377	030 121 005 N	US8949
16100-69495-83	US9291	06A 121 011 L	US9377	030 121 005 NV	US8949
16100-69535	US9325	06A 121 011 LX	US9377	030 121 005 NX	US8949
16100-79036	US9092	06A 121 011 T	US9377	030 121 008 D	US8949
16100-79036-77	US9092	06A 121 011 TX	US9377	030 121 008 DX	US8949
16100-79165-83	US9216	06A 121 012	US9377	030 131 005 T	US8949
16100-79445-83	US9293	06A 121 012 E	US9377	034 121 004	US9171
16100-WB001	US6700	06A 121 012 G	US9377	034 121 004 X	US9171
16110-15020	US9046	06A 121 012 GX	US9377	035 121 004 A	US9052
16110-15085	US9046	06A 121 012 X	US9377	035 121 004 AX	US9052
16110-16020-84	US9076	06C 121 004 H	US9429	036 121 005 B	US8976
16110-19025	US9045	06C 121 004 HX	US9429	036 121 005 E	US8976
16110-19026	US9045	06E121 018 B	US6249	036 121 005 Q	US8976
16110-19036	US9046	06E 121 005 D	US6146	037 121 005 B	US9065
16110-19036-84	US9046	06E 121 005 F	US6146	037 121 005 C	US9065
16110-19046	US9057	06E 121 005 G	US6249	037 121 010 C	US9065
16110-19047-77	US9057	06E 121 005 N	US6146	037 121 010 CX	US9065
16110-19065-84	US9098	06E 121 005 P	US6249	038 121 011 A	US9378
16110-19076	US9057	06E 121 008 N	US6146	038 121 011 AX	US9378
16110-19086	US9057	06E 121 008 P	US6249	038 121 011 G	US6034
16110-19106	US9334	06E 121 018 A	US6146	038 121 011 GX	US6034
16110-19115	US9076	06E 121 018 AX	US6146	038 121 011 J	US9378
16110-19146	US9271	06E 121 018 B	US6249	038 121 011 JX	US9378
16110-19155	US9075	06E 121 018 D	US6146	045 121 011 F	US6212
16110-19176	US9272	06F 121 011	US6022	045 121 011 H	US6212



**Volkswagen / Audi (cont'd.)**

050 121 010 CX	US9401
054 121 004 A	US9279
054 121 004 AX	US9279
068 121 005 A	US9065
068 121 005 B	US9066
068 121 005 C	US9066
069 121 005 D	US9071
074 121 005 M	US9274
074 121 005 N	US9274
077 121 004 A	US9226
077 121 004 F	US9362
077 121 004 G	US9226
077 121 004 HX	US9362
077 121 004 M	US9410
077 121 004 MX	US9410
077 121 004 N	US9410
077 121 004 NX	US9410
077 121 004 P	US9410
077 121 004 PX	US9410
078 121 004 C	US9263
078 121 004 CX	US9263
078 121 004 H	US9333
078 121 004 HX	US9333
078 121 004 J	US9333
078 121 004 JX	US9333
078 121 004 QX	US9333
078 121 006	US9333
078 121 006 A	US9446
078 121 006 AX	US9446
078 121 006 X	US9333
078 965 561	US11003
079 121 010 D	US6000
079 121 011 H	US6000
079 121 011 Q	US6000
079 121 012 B	US6000
079 121 012 D	US6000
079 121 012 K	US6702
079 121 013 P	US6702
079 121 013 T	US6702
079 121 014 D	US6000
079 121 014 F	US6702
251 965 561 B	US11034

**Volvo**

270681-0	US9049
271275-0	US9068
271855-0	US9339
271975-0	US9068
271985-0	US9339
271986-0	US9339
272474-0	US9339
272481-0	US9339
275619-0	US9049
461094-0	US9077
1218096-0	US9147
1218158-0	US9146
1257185-0	US9071
8694626-0	US9339
8694627-0	US9339
8694628-0	US9340
8694630-0	US9456
30650751-0	US9339
30684432-0	US9339
30731384-0	US6276
30751700-0	US9339
31219000	US9382
31293303-0	US8134

			
<b>US43N</b>	<b>US52</b>	<b>US61</b>	<b>US63</b>
			
<b>US64</b>	<b>US64-T</b>	<b>US65</b>	<b>US65N</b>
			
<b>US65N-T</b>	<b>US65-T</b>	<b>US66</b>	<b>US67</b>
			
<b>US72</b>	<b>US73</b>	<b>US76</b>	<b>US77</b>
			
<b>US78</b>	<b>US79</b>	<b>US85</b>	<b>US99</b>

**Note:** The photos or illustrations shown above are for reference purposes only. It does not suggest or imply that all the referenced pumps are manufactured by US Motor Works.

 <b>US127</b>	 <b>US310</b>	 <b>US470</b>	 <b>US488</b>
 <b>US670</b>	 <b>US713</b>	 <b>US723</b>	 <b>US773</b>
 <b>US819</b>	 <b>US821</b>	 <b>US835</b>	 <b>US843</b>
 <b>US850</b>	 <b>US855</b>	 <b>US861</b>	 <b>US895</b>
 <b>US896</b>	 <b>US898</b>	 <b>US898H</b>	 <b>US907</b>

**Note:** The photos or illustrations shown above are for reference purposes only. It does not suggest or imply that all the referenced pumps are manufactured by US Motor Works.



			
<b>US919</b>	<b>US926</b>	<b>US927</b>	<b>US932</b>
			
<b>US953</b>	<b>US953H</b>	<b>US960</b>	<b>US964</b>
			
<b>US975</b>	<b>US981</b>	<b>US984</b>	<b>US984H</b>
			
<b>US986</b>	<b>US1002</b>	<b>US1002H</b>	<b>US1006</b>
			
<b>US1010</b>	<b>US1012</b>	<b>US1018</b>	<b>US1018H</b>

**Note:** The photos or illustrations shown above are for reference purposes only. It does not suggest or imply that all the referenced pumps are manufactured by US Motor Works.

 <p style="text-align: center; background-color: black; color: white; padding: 2px;">US1021</p>	 <p style="text-align: center; background-color: black; color: white; padding: 2px;">US1028</p>	 <p style="text-align: center; background-color: black; color: white; padding: 2px;">US1028H</p>	 <p style="text-align: center; background-color: black; color: white; padding: 2px;">US1040</p>
 <p style="text-align: center; background-color: black; color: white; padding: 2px;">US1042</p>	 <p style="text-align: center; background-color: black; color: white; padding: 2px;">US1044</p>	 <p style="text-align: center; background-color: black; color: white; padding: 2px;">US1045</p>	 <p style="text-align: center; background-color: black; color: white; padding: 2px;">US1046</p>
 <p style="text-align: center; background-color: black; color: white; padding: 2px;">US1047</p>	 <p style="text-align: center; background-color: black; color: white; padding: 2px;">US1052</p>	 <p style="text-align: center; background-color: black; color: white; padding: 2px;">US1053</p>	 <p style="text-align: center; background-color: black; color: white; padding: 2px;">US1053H</p>
 <p style="text-align: center; background-color: black; color: white; padding: 2px;">US1061</p>	 <p style="text-align: center; background-color: black; color: white; padding: 2px;">US1069</p>	 <p style="text-align: center; background-color: black; color: white; padding: 2px;">US1070</p>	 <p style="text-align: center; background-color: black; color: white; padding: 2px;">US1075</p>
 <p style="text-align: center; background-color: black; color: white; padding: 2px;">US1075H</p>	 <p style="text-align: center; background-color: black; color: white; padding: 2px;">US1077</p>	 <p style="text-align: center; background-color: black; color: white; padding: 2px;">US1082</p>	 <p style="text-align: center; background-color: black; color: white; padding: 2px;">US1083</p>

**Note:** The photos or illustrations shown above are for reference purposes only. It does not suggest or imply that all the referenced pumps are manufactured by US Motor Works.

 <b>US1088</b>	 <b>US1096</b>	 <b>US1099</b>	 <b>US1100</b>
 <b>US1107</b>	 <b>US1109</b>	 <b>US1109H</b>	 <b>US1110</b>
 <b>US1114</b>	 <b>US1120</b>	 <b>US1120H</b>	 <b>US1121</b>
 <b>US1121H</b>	 <b>US1124</b>	 <b>US1127</b>	 <b>US1137</b>
 <b>US1137H</b>	 <b>US3400</b>	 <b>US3401</b>	 <b>US3401H</b>

**Note:** The photos or illustrations shown above are for reference purposes only. It does not suggest or imply that all the referenced pumps are manufactured by US Motor Works.



 <p style="text-align: center; background-color: black; color: white; padding: 2px;">US3403</p>	 <p style="text-align: center; background-color: black; color: white; padding: 2px;">US3404</p>	 <p style="text-align: center; background-color: black; color: white; padding: 2px;">US3406</p>	 <p style="text-align: center; background-color: black; color: white; padding: 2px;">US3408</p>
 <p style="text-align: center; background-color: black; color: white; padding: 2px;">US3409</p>	 <p style="text-align: center; background-color: black; color: white; padding: 2px;">US3410</p>	 <p style="text-align: center; background-color: black; color: white; padding: 2px;">US3411</p>	 <p style="text-align: center; background-color: black; color: white; padding: 2px;">US3412</p>
 <p style="text-align: center; background-color: black; color: white; padding: 2px;">US3413</p>	 <p style="text-align: center; background-color: black; color: white; padding: 2px;">US3414</p>	 <p style="text-align: center; background-color: black; color: white; padding: 2px;">US3705</p>	 <p style="text-align: center; background-color: black; color: white; padding: 2px;">US4002</p>
 <p style="text-align: center; background-color: black; color: white; padding: 2px;">US4003</p>	 <p style="text-align: center; background-color: black; color: white; padding: 2px;">US4005</p>	 <p style="text-align: center; background-color: black; color: white; padding: 2px;">US4014</p>	 <p style="text-align: center; background-color: black; color: white; padding: 2px;">US4014H</p>
 <p style="text-align: center; background-color: black; color: white; padding: 2px;">US4016</p>	 <p style="text-align: center; background-color: black; color: white; padding: 2px;">US4018</p>	 <p style="text-align: center; background-color: black; color: white; padding: 2px;">US4020</p>	 <p style="text-align: center; background-color: black; color: white; padding: 2px;">US4022</p>

**Note:** The photos or illustrations shown above are for reference purposes only. It does not suggest or imply that all the referenced pumps are manufactured by US Motor Works.

 <b>US4023</b>	 <b>US4024</b>	 <b>US4024H</b>	 <b>US4030N</b>
 <b>US4033</b>	 <b>US4034</b>	 <b>US4035</b>	 <b>US4037</b>
 <b>US4038</b>	 <b>US4038H</b>	 <b>US4039</b>	 <b>US4040</b>
 <b>US4041</b>	 <b>US4042</b>	 <b>US4044</b>	 <b>US4044H</b>
 <b>US4048</b>	 <b>US4049</b>	 <b>US4050</b>	 <b>US4051</b>

**Note:** The photos or illustrations shown above are for reference purposes only. It does not suggest or imply that all the referenced pumps are manufactured by US Motor Works.

 <p style="text-align: center; background-color: black; color: white; padding: 2px;">US4052</p>	 <p style="text-align: center; background-color: black; color: white; padding: 2px;">US4052H</p>	 <p style="text-align: center; background-color: black; color: white; padding: 2px;">US4053</p>	 <p style="text-align: center; background-color: black; color: white; padding: 2px;">US4054</p>
 <p style="text-align: center; background-color: black; color: white; padding: 2px;">US4055</p>	 <p style="text-align: center; background-color: black; color: white; padding: 2px;">US4056</p>	 <p style="text-align: center; background-color: black; color: white; padding: 2px;">US4057</p>	 <p style="text-align: center; background-color: black; color: white; padding: 2px;">US4059</p>
 <p style="text-align: center; background-color: black; color: white; padding: 2px;">US4060</p>	 <p style="text-align: center; background-color: black; color: white; padding: 2px;">US4061</p>	 <p style="text-align: center; background-color: black; color: white; padding: 2px;">US4062</p>	 <p style="text-align: center; background-color: black; color: white; padding: 2px;">US4065</p>
 <p style="text-align: center; background-color: black; color: white; padding: 2px;">US4066</p>	 <p style="text-align: center; background-color: black; color: white; padding: 2px;">US4068</p>	 <p style="text-align: center; background-color: black; color: white; padding: 2px;">US4069</p>	 <p style="text-align: center; background-color: black; color: white; padding: 2px;">US4070</p>
 <p style="text-align: center; background-color: black; color: white; padding: 2px;">US4077</p>	 <p style="text-align: center; background-color: black; color: white; padding: 2px;">US4078</p>	 <p style="text-align: center; background-color: black; color: white; padding: 2px;">US4079</p>	 <p style="text-align: center; background-color: black; color: white; padding: 2px;">US4081</p>

**Note:** The photos or illustrations shown above are for reference purposes only. It does not suggest or imply that all the referenced pumps are manufactured by US Motor Works.



 US4082	 US4083	 US4086	 US4087
 US4088	 US4089	 US4090	 US4091
 US4091-2	 US4093	 US4094	 US4095
 US4096	 US4097	 US4098	 US4099
 US4101	 US4102	 US4103	 US4104

**Note:** The photos or illustrations shown above are for reference purposes only. It does not suggest or imply that all the referenced pumps are manufactured by US Motor Works.





















 <p style="text-align: center; background-color: black; color: white; padding: 2px;">US4105</p>	 <p style="text-align: center; background-color: black; color: white; padding: 2px;">US4106</p>	 <p style="text-align: center; background-color: black; color: white; padding: 2px;">US4107</p>	 <p style="text-align: center; background-color: black; color: white; padding: 2px;">US4108</p>
 <p style="text-align: center; background-color: black; color: white; padding: 2px;">US4109</p>	 <p style="text-align: center; background-color: black; color: white; padding: 2px;">US4113</p>	 <p style="text-align: center; background-color: black; color: white; padding: 2px;">US4114</p>	 <p style="text-align: center; background-color: black; color: white; padding: 2px;">US4115</p>
 <p style="text-align: center; background-color: black; color: white; padding: 2px;">US4118</p>	 <p style="text-align: center; background-color: black; color: white; padding: 2px;">US4119</p>	 <p style="text-align: center; background-color: black; color: white; padding: 2px;">US4121</p>	 <p style="text-align: center; background-color: black; color: white; padding: 2px;">US4123</p>
 <p style="text-align: center; background-color: black; color: white; padding: 2px;">US4124</p>	 <p style="text-align: center; background-color: black; color: white; padding: 2px;">US4125</p>	 <p style="text-align: center; background-color: black; color: white; padding: 2px;">US4126</p>	 <p style="text-align: center; background-color: black; color: white; padding: 2px;">US4128</p>
 <p style="text-align: center; background-color: black; color: white; padding: 2px;">US4129</p>	 <p style="text-align: center; background-color: black; color: white; padding: 2px;">US4132</p>	 <p style="text-align: center; background-color: black; color: white; padding: 2px;">US4132-2</p>	 <p style="text-align: center; background-color: black; color: white; padding: 2px;">US5000</p>

**Note:** The photos or illustrations shown above are for reference purposes only. It does not suggest or imply that all the referenced pumps are manufactured by US Motor Works.

 <p><b>US5000P</b></p>	 <p><b>US5001</b></p>	 <p><b>US5003</b></p>	 <p><b>US5004</b></p>
 <p><b>US5006</b></p>	 <p><b>US5007</b></p>	 <p><b>US5008</b></p>	 <p><b>US5010</b></p>
 <p><b>US5012</b></p>	 <p><b>US5013</b></p>	 <p><b>US5014</b></p>	 <p><b>US5014P</b></p>
 <p><b>US5015</b></p>	 <p><b>US5016</b></p>	 <p><b>US5016H</b></p>	 <p><b>US5017</b></p>
 <p><b>US5019</b></p>	 <p><b>US5019H</b></p>	 <p><b>US5020</b></p>	 <p><b>US5022</b></p>

**Note:** The photos or illustrations shown above are for reference purposes only. It does not suggest or imply that all the referenced pumps are manufactured by US Motor Works.



















 <p style="text-align: center;"><b>US5023</b></p>	 <p style="text-align: center;"><b>US5027</b></p>	 <p style="text-align: center;"><b>US5028</b></p>	 <p style="text-align: center;"><b>US5029</b></p>
 <p style="text-align: center;"><b>US5030</b></p>	 <p style="text-align: center;"><b>US5031</b></p>	 <p style="text-align: center;"><b>US5032</b></p>	 <p style="text-align: center;"><b>US5033</b></p>
 <p style="text-align: center;"><b>US5035</b></p>	 <p style="text-align: center;"><b>US5036</b></p>	 <p style="text-align: center;"><b>US5037</b></p>	 <p style="text-align: center;"><b>US5038</b></p>
 <p style="text-align: center;"><b>US5038H</b></p>	 <p style="text-align: center;"><b>US5040</b></p>	 <p style="text-align: center;"><b>US5041</b></p>	 <p style="text-align: center;"><b>US5043</b></p>
 <p style="text-align: center;"><b>US5045</b></p>	 <p style="text-align: center;"><b>US5048</b></p>	 <p style="text-align: center;"><b>US5049</b></p>	 <p style="text-align: center;"><b>US5049H</b></p>

**Note:** The photos or illustrations shown above are for reference purposes only. It does not suggest or imply that all the referenced pumps are manufactured by US Motor Works.

 <b>US5050</b>	 <b>US5051</b>	 <b>US5054</b>	 <b>US5056</b>
 <b>US5057</b>	 <b>US5058</b>	 <b>US5062</b>	 <b>US5063</b>
 <b>US5064</b>	 <b>US5066</b>	 <b>US5067</b>	 <b>US5068</b>
 <b>US5069</b>	 <b>US5070</b>	 <b>US5072</b>	 <b>US5073</b>
 <b>US5074</b>	 <b>US5075</b>	 <b>US5076</b>	 <b>US5077</b>

**Note:** The photos or illustrations shown above are for reference purposes only. It does not suggest or imply that all the referenced pumps are manufactured by US Motor Works.

 <b>US5077H</b>	 <b>US5078</b>	 <b>US5079</b>	 <b>US5081</b>
 <b>US5084</b>	 <b>US5085</b>	 <b>US5086</b>	 <b>US5087</b>
 <b>US5089</b>	 <b>US5089H</b>	 <b>US5090</b>	 <b>US5092</b>
 <b>US5097</b>	 <b>US5099</b>	 <b>US6000</b>	 <b>US6001</b>
 <b>US6003</b>	 <b>US6006</b>	 <b>US6007</b>	 <b>US6008</b>

**Note:** The photos or illustrations shown above are for reference purposes only. It does not suggest or imply that all the referenced pumps are manufactured by US Motor Works.





US6009



US6009-T



US6018



US6020



US6022



US6023



US6030



US6034



US6037



US6038



US6046



US6047



US6048



US6049



US6050



US6056



US6075



US6142



US6143



US6144

**Note:** The photos or illustrations shown above are for reference purposes only. It does not suggest or imply that all the referenced pumps are manufactured by US Motor Works.



















			
US6145	US6146	US6149	US6152
			
US6154	US6155	US6156	US6159
			
US6160	US6184	US6186	US6197
			
US6198	US6211	US6212	US6213
			
US6215	US6216	US6217	US6218

**Note:** The photos or illustrations shown above are for reference purposes only. It does not suggest or imply that all the referenced pumps are manufactured by US Motor Works.

 <b>US6219</b>	 <b>US6220</b>	 <b>US6221</b>	 <b>US6222</b>
 <b>US6223</b>	 <b>US6227</b>	 <b>US6228</b>	 <b>US6229</b>
 <b>US6231</b>	 <b>US6232</b>	 <b>US6233</b>	 <b>US6235</b>
 <b>US6238</b>	 <b>US6240</b>	 <b>US6241</b>	 <b>US6242</b>
 <b>US6244</b>	 <b>US6247</b>	 <b>US6249</b>	 <b>US6250</b>

**Note:** The photos or illustrations shown above are for reference purposes only. It does not suggest or imply that all the referenced pumps are manufactured by US Motor Works.











 US6251	 US6252	 US6273	 US6276
 US6287	 US6292	 US6295	 US6336
 US6338	 US6341	 US6349	 US6350
 US6599	 US6654	 US6657	 US6662
 US6680	 US6681	 US6682	 US6687

**Note:** The photos or illustrations shown above are for reference purposes only. It does not suggest or imply that all the referenced pumps are manufactured by US Motor Works.

 <b>US6689</b>	 <b>US6692</b>	 <b>US6693</b>	 <b>US6699</b>
 <b>US6700</b>	 <b>US6702</b>	 <b>US6703</b>	 <b>US6708</b>
 <b>US7100</b>	 <b>US7101</b>	 <b>US7104</b>	 <b>US7105</b>
 <b>US7106</b>	 <b>US7108</b>	 <b>US7110</b>	 <b>US7110H</b>
 <b>US7111</b>	 <b>US7113</b>	 <b>US7114</b>	 <b>US7115</b>

**Note:** The photos or illustrations shown above are for reference purposes only. It does not suggest or imply that all the referenced pumps are manufactured by US Motor Works.





















 <b>US7117</b>	 <b>US7118</b>	 <b>US7120</b>	 <b>US7121</b>
 <b>US7121-2</b>	 <b>US7122</b>	 <b>US7124</b>	 <b>US7126</b>
 <b>US7127</b>	 <b>US7128</b>	 <b>US7129</b>	 <b>US7131</b>
 <b>US7135</b>	 <b>US7136</b>	 <b>US7137</b>	 <b>US7139</b>
 <b>US7140</b>	 <b>US7141</b>	 <b>US7145</b>	 <b>US7145HN</b>

**Note:** The photos or illustrations shown above are for reference purposes only. It does not suggest or imply that all the referenced pumps are manufactured by US Motor Works.



			
<b>US7145N</b>	<b>US7146</b>	<b>US7148</b>	<b>US7150</b>
			
<b>US7151</b>	<b>US7152</b>	<b>US7153</b>	<b>US7156</b>
			
<b>US7158</b>	<b>US7159</b>	<b>US7160</b>	<b>US7161</b>
			
<b>US7162</b>	<b>US7163</b>	<b>US7164</b>	<b>US7165</b>
			
<b>US7167</b>	<b>US7168</b>	<b>US7169</b>	<b>US8102</b>

**Note:** The photos or illustrations shown above are for reference purposes only. It does not suggest or imply that all the referenced pumps are manufactured by US Motor Works.

 <b>US8103</b>	 <b>US8104</b>	 <b>US8105</b>	 <b>US8106</b>
 <b>US8107</b>	 <b>US8108</b>	 <b>US8109</b>	 <b>US8111</b>
 <b>US8112</b>	 <b>US8114</b>	 <b>US8115</b>	 <b>US8116</b>
 <b>US8117</b>	 <b>US8118</b>	 <b>US8119</b>	 <b>US8120</b>
 <b>US8121</b>	 <b>US8123</b>	 <b>US8124</b>	 <b>US8125</b>

**Note:** The photos or illustrations shown above are for reference purposes only. It does not suggest or imply that all the referenced pumps are manufactured by US Motor Works.

 US8134	 US8135	 US8136	 US8137
 US8138	 US8139	 US8140	 US8141
 US8141P	 US8141P-T	 US8141-T	 US8142
 US8142-T	 US8143	 US8144	 US8145
 US8146	 US8147	 US8148	 US8149

**Note:** The photos or illustrations shown above are for reference purposes only. It does not suggest or imply that all the referenced pumps are manufactured by US Motor Works.























			
US8150	US8151	US8152	US8153
			
US8154	US8155	US8157	US8158
			
US8159	US8160	US8161	US8162
			
US8163	US8164	US8908	US8910
			
US8914	US8916	US8917	US8918

**Note:** The photos or illustrations shown above are for reference purposes only. It does not suggest or imply that all the referenced pumps are manufactured by US Motor Works.

			
<b>US8920</b>	<b>US8921</b>	<b>US8922</b>	<b>US8925</b>
			
<b>US8926</b>	<b>US8927</b>	<b>US8928</b>	<b>US8931</b>
			
<b>US8932</b>	<b>US8933</b>	<b>US8934</b>	<b>US8935</b>
			
<b>US8936</b>	<b>US8937</b>	<b>US8938</b>	<b>US8939</b>
			
<b>US8940</b>	<b>US8944</b>	<b>US8945</b>	<b>US8946</b>

**Note:** The photos or illustrations shown above are for reference purposes only. It does not suggest or imply that all the referenced pumps are manufactured by US Motor Works.

 <p style="text-align: center; background-color: black; color: white; padding: 2px;">US8948</p>	 <p style="text-align: center; background-color: black; color: white; padding: 2px;">US8949</p>	 <p style="text-align: center; background-color: black; color: white; padding: 2px;">US8951</p>	 <p style="text-align: center; background-color: black; color: white; padding: 2px;">US8952</p>
 <p style="text-align: center; background-color: black; color: white; padding: 2px;">US8954</p>	 <p style="text-align: center; background-color: black; color: white; padding: 2px;">US8955</p>	 <p style="text-align: center; background-color: black; color: white; padding: 2px;">US8956</p>	 <p style="text-align: center; background-color: black; color: white; padding: 2px;">US8959</p>
 <p style="text-align: center; background-color: black; color: white; padding: 2px;">US8960</p>	 <p style="text-align: center; background-color: black; color: white; padding: 2px;">US8963</p>	 <p style="text-align: center; background-color: black; color: white; padding: 2px;">US8967</p>	 <p style="text-align: center; background-color: black; color: white; padding: 2px;">US8968</p>
 <p style="text-align: center; background-color: black; color: white; padding: 2px;">US8970</p>	 <p style="text-align: center; background-color: black; color: white; padding: 2px;">US8971</p>	 <p style="text-align: center; background-color: black; color: white; padding: 2px;">US8972</p>	 <p style="text-align: center; background-color: black; color: white; padding: 2px;">US8973</p>
 <p style="text-align: center; background-color: black; color: white; padding: 2px;">US8974</p>	 <p style="text-align: center; background-color: black; color: white; padding: 2px;">US8975</p>	 <p style="text-align: center; background-color: black; color: white; padding: 2px;">US8976</p>	 <p style="text-align: center; background-color: black; color: white; padding: 2px;">US8977</p>

**Note:** The photos or illustrations shown above are for reference purposes only. It does not suggest or imply that all the referenced pumps are manufactured by US Motor Works.



			
<b>US8978</b>	<b>US8979</b>	<b>US8980</b>	<b>US8981</b>
			
<b>US8982</b>	<b>US8983</b>	<b>US8984</b>	<b>US8984-2</b>
			
<b>US8985</b>	<b>US8987</b>	<b>US8990</b>	<b>US8996</b>
			
<b>US8998</b>	<b>US8999</b>	<b>US9003</b>	<b>US9005</b>
			
<b>US9008</b>	<b>US9009</b>	<b>US9010</b>	<b>US9011</b>

**Note:** The photos or illustrations shown above are for reference purposes only. It does not suggest or imply that all the referenced pumps are manufactured by US Motor Works.

 <b>US9012</b>	 <b>US9015</b>	 <b>US9016</b>	 <b>US9017</b>
 <b>US9018</b>	 <b>US9020</b>	 <b>US9021</b>	 <b>US9025</b>
 <b>US9026</b>	 <b>US9027</b>	 <b>US9028</b>	 <b>US9029</b>
 <b>US9031</b>	 <b>US9033</b>	 <b>US9034</b>	 <b>US9035</b>
 <b>US9040N</b>	 <b>US9041</b>	 <b>US9043N</b>	 <b>US9044</b>

**Note:** The photos or illustrations shown above are for reference purposes only. It does not suggest or imply that all the referenced pumps are manufactured by US Motor Works.

			
<b>US9045</b>	<b>US9046</b>	<b>US9047</b>	<b>US9047-2</b>
			
<b>US9048</b>	<b>US9049</b>	<b>US9050</b>	<b>US9052</b>
			
<b>US9053</b>	<b>US9056</b>	<b>US9057</b>	<b>US9058</b>
			
<b>US9059</b>	<b>US9060</b>	<b>US9061</b>	<b>US9063</b>
			
<b>US9064</b>	<b>US9065</b>	<b>US9065-2</b>	<b>US9066</b>

**Note:** The photos or illustrations shown above are for reference purposes only. It does not suggest or imply that all the referenced pumps are manufactured by US Motor Works.



			
US9067	US9068	US9069	US9071
			
US9074	US9075	US9076	US9077
			
US9078	US9080	US9082	US9083
			
US9084	US9085	US9086	US9092
			
US9093	US9093	US9094	US9097

**Note:** The photos or illustrations shown above are for reference purposes only. It does not suggest or imply that all the referenced pumps are manufactured by US Motor Works.

			
<b>US9098</b>	<b>US9099</b>	<b>US9099-2</b>	<b>US9100</b>
			
<b>US9102</b>	<b>US9104</b>	<b>US9105</b>	<b>US9106</b>
			
<b>US9107</b>	<b>US9108</b>	<b>US9109</b>	<b>US9110</b>
			
<b>US9111</b>	<b>US9114</b>	<b>US9115</b>	<b>US9116</b>
			
<b>US9117</b>	<b>US9119</b>	<b>US9120</b>	<b>US9122</b>

**Note:** The photos or illustrations shown above are for reference purposes only. It does not suggest or imply that all the referenced pumps are manufactured by US Motor Works.





















 <b>US9128</b>	 <b>US9129</b>	 <b>US9130</b>	 <b>US9131</b>
 <b>US9132</b>	 <b>US9133</b>	 <b>US9134</b>	 <b>US9140</b>
 <b>US9141</b>	 <b>US9142</b>	 <b>US9145</b>	 <b>US9146</b>
 <b>US9147</b>	 <b>US9149</b>	 <b>US9150</b>	 <b>US9152</b>
 <b>US9153</b>	 <b>US9154</b>	 <b>US9155</b>	 <b>US9160</b>

**Note:** The photos or illustrations shown above are for reference purposes only. It does not suggest or imply that all the referenced pumps are manufactured by US Motor Works.



			
<b>US9161</b>	<b>US9162</b>	<b>US9163</b>	<b>US9165</b>
			
<b>US9166</b>	<b>US9167</b>	<b>US9168</b>	<b>US9170</b>
			
<b>US9171</b>	<b>US9172</b>	<b>US9173</b>	<b>US9175</b>
			
<b>US9176</b>	<b>US9177</b>	<b>US9179</b>	<b>US9180</b>
			
<b>US9181</b>	<b>US9189</b>	<b>US9193</b>	<b>US9198</b>

**Note:** The photos or illustrations shown above are for reference purposes only. It does not suggest or imply that all the referenced pumps are manufactured by US Motor Works.



















 <p style="text-align: center; background-color: black; color: white; padding: 2px;">US9200</p>	 <p style="text-align: center; background-color: black; color: white; padding: 2px;">US9201</p>	 <p style="text-align: center; background-color: black; color: white; padding: 2px;">US9202</p>	 <p style="text-align: center; background-color: black; color: white; padding: 2px;">US9203</p>
 <p style="text-align: center; background-color: black; color: white; padding: 2px;">US9206</p>	 <p style="text-align: center; background-color: black; color: white; padding: 2px;">US9207</p>	 <p style="text-align: center; background-color: black; color: white; padding: 2px;">US9208</p>	 <p style="text-align: center; background-color: black; color: white; padding: 2px;">US9209</p>
 <p style="text-align: center; background-color: black; color: white; padding: 2px;">US9211</p>	 <p style="text-align: center; background-color: black; color: white; padding: 2px;">US9212</p>	 <p style="text-align: center; background-color: black; color: white; padding: 2px;">US9213</p>	 <p style="text-align: center; background-color: black; color: white; padding: 2px;">US9214</p>
 <p style="text-align: center; background-color: black; color: white; padding: 2px;">US9215</p>	 <p style="text-align: center; background-color: black; color: white; padding: 2px;">US9216</p>	 <p style="text-align: center; background-color: black; color: white; padding: 2px;">US9218</p>	 <p style="text-align: center; background-color: black; color: white; padding: 2px;">US9219</p>
 <p style="text-align: center; background-color: black; color: white; padding: 2px;">US9220</p>	 <p style="text-align: center; background-color: black; color: white; padding: 2px;">US9221</p>	 <p style="text-align: center; background-color: black; color: white; padding: 2px;">US9222</p>	 <p style="text-align: center; background-color: black; color: white; padding: 2px;">US9223</p>

**Note:** The photos or illustrations shown above are for reference purposes only. It does not suggest or imply that all the referenced pumps are manufactured by US Motor Works.

			
<b>US9224</b>	<b>US9225</b>	<b>US9226</b>	<b>US9227</b>
			
<b>US9228</b>	<b>US9230</b>	<b>US9231</b>	<b>US9232</b>
			
<b>US9234</b>	<b>US9236</b>	<b>US9237</b>	<b>US9238</b>
			
<b>US9239</b>	<b>US9241</b>	<b>US9242</b>	<b>US9245</b>
			
<b>US9250</b>	<b>US9251</b>	<b>US9252</b>	<b>US9253</b>

**Note:** The photos or illustrations shown above are for reference purposes only. It does not suggest or imply that all the referenced pumps are manufactured by US Motor Works.



 <p style="text-align: center; background-color: black; color: white; padding: 2px;">US9254</p>	 <p style="text-align: center; background-color: black; color: white; padding: 2px;">US9255</p>	 <p style="text-align: center; background-color: black; color: white; padding: 2px;">US9256</p>	 <p style="text-align: center; background-color: black; color: white; padding: 2px;">US9257</p>
 <p style="text-align: center; background-color: black; color: white; padding: 2px;">US9258</p>	 <p style="text-align: center; background-color: black; color: white; padding: 2px;">US9259</p>	 <p style="text-align: center; background-color: black; color: white; padding: 2px;">US9260</p>	 <p style="text-align: center; background-color: black; color: white; padding: 2px;">US9261</p>
 <p style="text-align: center; background-color: black; color: white; padding: 2px;">US9262</p>	 <p style="text-align: center; background-color: black; color: white; padding: 2px;">US9263</p>	 <p style="text-align: center; background-color: black; color: white; padding: 2px;">US9264</p>	 <p style="text-align: center; background-color: black; color: white; padding: 2px;">US9268</p>
 <p style="text-align: center; background-color: black; color: white; padding: 2px;">US9269</p>	 <p style="text-align: center; background-color: black; color: white; padding: 2px;">US9270</p>	 <p style="text-align: center; background-color: black; color: white; padding: 2px;">US9271</p>	 <p style="text-align: center; background-color: black; color: white; padding: 2px;">US9272</p>
 <p style="text-align: center; background-color: black; color: white; padding: 2px;">US9272-2</p>	 <p style="text-align: center; background-color: black; color: white; padding: 2px;">US9273</p>	 <p style="text-align: center; background-color: black; color: white; padding: 2px;">US9274</p>	 <p style="text-align: center; background-color: black; color: white; padding: 2px;">US9274-20</p>

**Note:** The photos or illustrations shown above are for reference purposes only. It does not suggest or imply that all the referenced pumps are manufactured by US Motor Works.

			
<b>US9275</b>	<b>US9276</b>	<b>US9277</b>	<b>US9278</b>
			
<b>US9279</b>	<b>US9280</b>	<b>US9282</b>	<b>US9284</b>
			
<b>US9288</b>	<b>US9289</b>	<b>US9291</b>	<b>US9292</b>
			
<b>US9293</b>	<b>US9299</b>	<b>US9300</b>	<b>US9301</b>
			
<b>US9304</b>	<b>US9305</b>	<b>US9306</b>	<b>US9307</b>

**Note:** The photos or illustrations shown above are for reference purposes only. It does not suggest or imply that all the referenced pumps are manufactured by US Motor Works.



 <p style="text-align: center; background-color: black; color: white; padding: 2px;">US9309</p>	 <p style="text-align: center; background-color: black; color: white; padding: 2px;">US9310</p>	 <p style="text-align: center; background-color: black; color: white; padding: 2px;">US9311</p>	 <p style="text-align: center; background-color: black; color: white; padding: 2px;">US9313</p>
 <p style="text-align: center; background-color: black; color: white; padding: 2px;">US9314</p>	 <p style="text-align: center; background-color: black; color: white; padding: 2px;">US9315</p>	 <p style="text-align: center; background-color: black; color: white; padding: 2px;">US9318</p>	 <p style="text-align: center; background-color: black; color: white; padding: 2px;">US9320</p>
 <p style="text-align: center; background-color: black; color: white; padding: 2px;">US9321</p>	 <p style="text-align: center; background-color: black; color: white; padding: 2px;">US9324</p>	 <p style="text-align: center; background-color: black; color: white; padding: 2px;">US9325</p>	 <p style="text-align: center; background-color: black; color: white; padding: 2px;">US9327</p>
 <p style="text-align: center; background-color: black; color: white; padding: 2px;">US9328</p>	 <p style="text-align: center; background-color: black; color: white; padding: 2px;">US9332</p>	 <p style="text-align: center; background-color: black; color: white; padding: 2px;">US9333</p>	 <p style="text-align: center; background-color: black; color: white; padding: 2px;">US9334</p>
 <p style="text-align: center; background-color: black; color: white; padding: 2px;">US9337</p>	 <p style="text-align: center; background-color: black; color: white; padding: 2px;">US9338</p>	 <p style="text-align: center; background-color: black; color: white; padding: 2px;">US9339</p>	 <p style="text-align: center; background-color: black; color: white; padding: 2px;">US9340</p>

**Note:** The photos or illustrations shown above are for reference purposes only. It does not suggest or imply that all the referenced pumps are manufactured by US Motor Works.







			
<b>US9342</b>	<b>US9343</b>	<b>US9344</b>	<b>US9345</b>
			
<b>US9346</b>	<b>US9348</b>	<b>US9349</b>	<b>US9351</b>
			
<b>US9352</b>	<b>US9353</b>	<b>US9354</b>	<b>US9356</b>
			
<b>US9359</b>	<b>US9360</b>	<b>US9362</b>	<b>US9364</b>
			
<b>US9365</b>	<b>US9368</b>	<b>US9369</b>	<b>US9371</b>

**Note:** The photos or illustrations shown above are for reference purposes only. It does not suggest or imply that all the referenced pumps are manufactured by US Motor Works.



















 <b>US9374</b>	 <b>US9375</b>	 <b>US9376</b>	 <b>US9377</b>
 <b>US9378</b>	 <b>US9379</b>	 <b>US9380</b>	 <b>US9382</b>
 <b>US9383</b>	 <b>US9384</b>	 <b>US9385</b>	 <b>US9388</b>
 <b>US9389</b>	 <b>US9393</b>	 <b>US9394</b>	 <b>US9395</b>
 <b>US9399</b>	 <b>US9401</b>	 <b>US9402</b>	 <b>US9403</b>

**Note:** The photos or illustrations shown above are for reference purposes only. It does not suggest or imply that all the referenced pumps are manufactured by US Motor Works.

 US9405	 US9406	 US9410	 US9414
 US9415	 US9416	 US9419	 US9421
 US9426	 US9427	 US9427-2	 US9429
 US9434	 US9440	 US9446	 US9448
 US9449	 US9450	 US9456	 US9460

**Note:** The photos or illustrations shown above are for reference purposes only. It does not suggest or imply that all the referenced pumps are manufactured by US Motor Works.



			
US9461	US9462	US9463	US9464
			
US9465	US9467	US9468	US9470
			
US9471	US9472	US9473	US9474
			
US9475	US9480	US9486	US9488
			
US9489	US9489-2	US9493	US9494

**Note:** The photos or illustrations shown above are for reference purposes only. It does not suggest or imply that all the referenced pumps are manufactured by US Motor Works.

 <p>US9495</p>	 <p>US9496</p>	 <p>US11001</p>	 <p>US11002</p>
 <p>US11003</p>	 <p>US11004</p>	 <p>US11005</p>	 <p>US11006</p>
 <p>US11007</p>	 <p>US11008</p>	 <p>US11009</p>	 <p>US11011</p>
 <p>US11012</p>	 <p>US11013</p>	 <p>US11014</p>	 <p>US11015</p>
 <p>US11017</p>	 <p>US11024</p>	 <p>US11034</p>	

**Note:** The photos or illustrations shown above are for reference purposes only. It does not suggest or imply that all the referenced pumps are manufactured by US Motor Works.

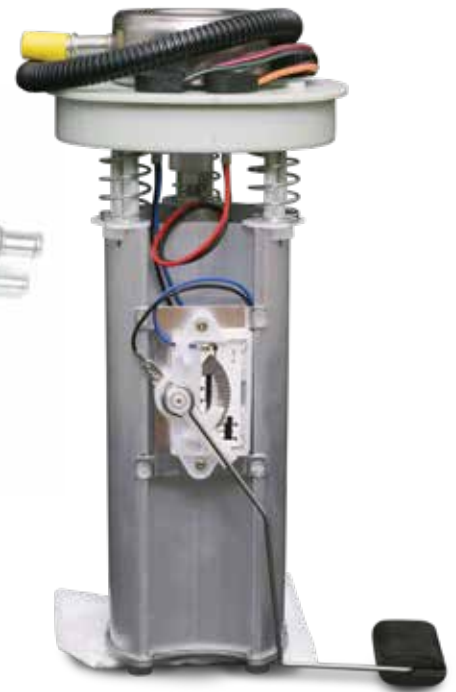

## Product Development

With our 6 simple steps in new product development process, US Motor Works sits in the driver's seat when it comes to quick and precise product development. From product definition to design, production planning and preparations, prototype production and final production run, it's a mere 120 days or less. US Motor Work's OPEX mentality enables us to be on the leading edge of product development.





US Motor Works, LLC  
14710 Brown Avenue  
Santa Fe Springs, CA 90706, USA  
Tel: 949-404-3436  
Fax: 949-404-6770  
usa@usmotorworks.com  
www.usmotorworks.com

**NEW QUALITY - RELIABILITY**

**MARKETING COMMUNICATION PRODUCTS BULLETIN - NEW AUTOMOTIVE COOLING PRODUCTS**

Date of Release: July 26, 2015      Availability: In Stock

 32347 12 - 17 Super 3.0L OEM # 8011473AC	 32411 12 - 17 Toyota 3.5L 4.0L OEM # 14210-0P000	 US10024 22 - 23 Mitsubishi Galant 3.0L engine OEM # 8011835 13 44
 US10024 02 - 05 Volkswagen Multi engine OEM # 251 905 501 B	 US8073 03 - 10 Mercedes-Benz S-Class SLS OEM # 275 260 01 01	 US8001 04 - 17 Renault SCL OEM # 11 51 7 632 428
 US2706 04 - 11 BMW 4.0L OEM # 11 51 7 549 263	 US8119 15 - 17 Volvo 2.4L OEM # 19200-1A2 A41	 US8119 15 - 17 Volvo 2.0L OEM # 19200-1A2 043
 US8119 14 - 17 General Motors B.35 OEM # 12962676	 US8134 11 - 16 Volvo S.35 OEM # 2129262-0	

Please visit [www.usmotorworks.com](http://www.usmotorworks.com) for detailed application or contact customer service for further information.







## E.I.T. Electronic Information Technology

US Motor Works utilizes proprietary Electronic Information Technology as a communication and information platform for new product releases, bulletins, technical updates and general client correspondence. USMW E.I.T. is internet based with 24/7 365 days a year access to keep our clients up to date in the most efficient and expedient format possible.

As part of our E.I.T. Platform we have also added the Pro Tech Center to the [www.usmotorworks.com](http://www.usmotorworks.com) website. The US Motor Works PRO Tech Center is designed to keep you up to date with the latest articles, product releases, tech tips and videos.





## A.E.T.S. Advanced Engineering & Technical Support

US Motor Works has created an engineering and technical environment from the design process to the final production product. Starting with CAD/CAM 3-D projections, computerized testing, a complete manufacturing plan and ending with a reliable distribution network. US Motor Works is able to track and control all related design, quality processes and packaging with specifications and manufacturing excellence in mind.



## Manufacturing

Our State-of-the-art manufacturing utilizes our four principles; Supply Chain (improved flow), Quality Management (robust quality assurance), Production (pull & flow and 5S) and Measurements by KPI's (Key performance indicators). With these manufacturing principles and our continuous improvement ideology under the OPEX umbrella, US Motor Works continues to be the front runner among the industry leaders.



## In-House Marketing & Graphic Design

Our In-house marketing and graphic design department helps to ensure our branding is at the forefront of the automotive industry. Working closely with category managers allows us to create powerful advertisement campaigns, marketing sales tools and educational pieces.

Along with the printed media, our team also works on a digital platform via brand specific websites and social media. Through social media we are able to connect with the end users and get genuine testimony of our products, thus making each brand recognizable and a name they can trust.





# CERTIFICATE OF REGISTRATION



**American Systems REGISTRAR**  
5281 Clyde Park Ave. SW, Suite 1  
Wyoming, MI 49509 USA  
www.asrworldwide.com  
616-942-6273



American Systems Registrar, LLC, a provider of third-party system registration and accredited by the ANSI-ASQ National Accreditation Board attests that:

## **US MOTOR WORKS, LLC**

**14722 ANSON AVENUE  
SANTA FE SPRINGS, CA 90670**

with a scope of:

### **MANUFACTURE OF AUTOMOTIVE COMPONENTS FOR OEM AND AFTERMARKET PRODUCTS**

has established a quality management system that is in conformance with the International Quality System Standard

### **ISO 9001:2015**

ASR Certificate Number: ..... 6569  
Date of Certification: ..... September 18, 2016  
Date of Certification Expiration:..... September 17, 2019  
Date of Initial Registration:..... October 18, 2010  
Revision:..... 1  
Re-Issue Date: ..... September 22, 2016

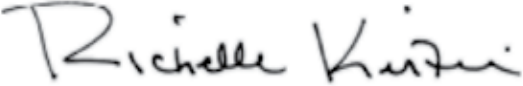
  
\_\_\_\_\_  
President

## **CERTIFICATE OF REGISTRATION**



# Trusted by professionals around the world

US Motor Works, LLC and its employees are committed to providing an extensive line of consistent high quality products and the finest customer service and satisfaction.

95

- US Motor Works Established in Commerce, Ca.

97

- Scaled up Manufacturing of Water Pumps to 30,000/Month

99

- Moved to a 30,000 sq. ft. facility in Cerritos, Ca.
- Purchased Fan Clutch Division

05

- Entered Joint Venture with Chinese Casting Manufacturer

06

- 40% Annual growth
- Expanded Facility to 50,000 sq. ft.

07

- Production reached 1,000,000 Water Pumps per year
- Opened Engineering Facility in China

08

- Development & Distribution of Electric Fuel Pumps

09

- Moved to a 80,000 sq. ft. facility in Santa Fe Springs, Ca.

10

- Became ISO 9001:2008 Certified

11

- Timing Kits w/ Water Pumps added to the product line
- Approved Vendor by APA & Vipar HD

12

- Launched HD product lines
- Approved Vendor by ADN Silver
- Expanded the facility to 100,000 sq. ft.

13

- Approved Vendor by Alliance & ADN Gold

14

- Expanded HD offering into Oil Pumps & Mechanical Transfer Pumps

15

- Celebrated 20th Anniversary
- First Automotive aftermarket company certified as ISO 9001:2015
- AASA top 100 Automotive Aftermarket suppliers

16

- Purchased Pacer Performance, est.1965
- Derale Performance, est.1975
- Introduced Max Cooling Kits
- USMW Professional Series undergoes re-branding
- Expanded Facility adding 50,000 sq. ft of Manufacturing & Warehouse

17

- Campaign launch for USMW HD
- Operating out of two facilities in CA (Los Angeles & Santa Fe Springs)
- More than 150,000 SQ FT of Manufacturing and Distribution

18

- Performance Division certified as ISO 9001:2015
- Introduction of mechanical fuel pumps to the line
- Auto Care Association recognizes Max Cooling Kit as an official part type (56846) water pump with fan clutch



US Motor Works, LLC  
14722 Anson Avenue  
Santa Fe Springs, Ca 90670 USA

Tel: (562) 404-0488  
Fax: (562) 404-8770  
email: info@usmotorworks.com



US Motor Works Performance Division  
3901 Medford St.  
Los Angeles, Ca 90063 USA

Tel: (323) 266-3850  
Fax: (323) 263-3948

[www.usmotorworks.com](http://www.usmotorworks.com)



US INDUSTRIAL WORKS, LLC  
14322 Arden Way  
Santa Fe Springs, La 70150  
Tel: (504) 404-0100  
Fax: (504) 404-0770  
usa@usworks.com



*Trusted by professionals around the world*

